

A comparison of FRP-sandwich penetrating impact test methods

Martin Hildebrand

VTT Manufacturing Technology



ISBN 951-38-4939-2

ISSN 1235-0621

Copyright © Valtion teknillinen tutkimuskeskus (VTT) 1996

JULKAISIJA – UTGIVARE – PUBLISHER

Valtion teknillinen tutkimuskeskus (VTT), Vuorimiehentie 5, PL 42, 02151 ESPOO
puh. vaihde (90) 4561, telekopio 456 4374, teleksi 125 175 vttin sf

Statens tekniska forskningscentral (VTT), Bergsmansvägen 5, PB 42, 02151 ESBO
tel. växel (90) 4561, telefax 456 4374, telex 125 175 vttin sf

Technical Research Centre of Finland (VTT), Vuorimiehentie 5, P.O.Box 42, FIN-02151 ESPOO, Finland
phone internat. + 358 0 4561, telefax + 358 0 456 4374, telex 125 175 vttin sf

VTT Valmistustekniikka, Laiva- ja konetekniikka, Tekniikantie 12, PL 1705, 02044 VTT
puh. vaihde (09) 4561, faksi (09) 455 0619

VTT Tillverknings teknik, Skepps- och maskinteknik, Teknikvägen 12, PB 1705, 02044 VTT
tel. växel (09) 4561, fax (09) 455 0619

VTT Manufacturing Technology, Maritime and Mechanical Engineering, Tekniikantie 12, P.O.Box 1705,
FIN-02044 VTT, Finland
phone internat. + 358 9 4561, fax + 358 9 455 0619

Hildebrand, Martin. A comparison of FRP-sandwich penetrating impact test methods. Espoo 1996. Technical Research Centre of Finland, VTT Publications 281. 33 p. + app. 1 p.

UCD 691.7:620.178.6:539.4

Keywords impact tests, penetration tests, test methods, methods, tests, comparison, sandwich panels, sandwich structures, fibres, reinforced plastics, standards, failure, models, strength

ABSTRACT

The main objective of this project is to identify the test methods which provide useful results for the different types of penetrating impacts occurring in sandwich structures.

A series of penetrating impact tests on FRP-sandwich panels is performed using three different test methods and the results of the test methods are compared.

The test methods used are the standardised method ISO 6603 and two non-standardised methods. The first non-standardised method uses a pyramid-shaped impactor instead of the cylindrical impactor used in the ISO 6603 method. In the second non-standardised method, the impact test is performed quasi-statically using a cylindrical impactor.

Possible stages of failure occurring in FRP-sandwich during a penetrating impact are illustrated. A comprehensive test method should be able to provoke various failure modes, as observed in impact failures of actual sandwich structures.

The results obtained with the three test methods lead to a different ranking in impact strength of the panels. Hence, impact test results obtained with different test methods are not even qualitatively comparable.

The pyramid-shaped impactor is able to generate clearly more failure modes than the cylindrical impactor in the ISO 6603 method. Therefore, it is considered to be of more practical value for determining the impact strength of FRP-sandwich structures.

CONTENTS

ABSTRACT	3
1 INTRODUCTION.....	5
2 STANDARDISED IMPACT TEST METHODS.....	7
3 NON-STANDARDISED IMPACT TEST METHODS.....	9
4 DIFFERENT STAGES OF FAILURE OCCURRING DURING A PENETRATING IMPACT	11
5 COMPARISON OF TEST METHODS	14
5.1 ISO 6603	14
5.2 Pyramid.....	15
5.3 Slow impact.....	16
6 TESTED MATERIAL.....	17
7 RESULTS	18
7.1 Force-displacement curves and failure modes	18
7.1.1 ISO 6603.....	18
7.1.2 Pyramid.....	19
7.1.3 Slow impact	21
7.2 Force and energy at penetration of outer face	22
7.3 Force and energy at penetration of inner face	25
8 CONCLUSIONS	29
9 ACKNOWLEDGEMENTS.....	31
REFERENCES	32
 APPENDICES	
TEST RESULTS	1/1

1 INTRODUCTION

Fibre-reinforced plastic (FRP) structures have become popular in many vehicles on rail, road and sea. In many cases, the requirements of light weight and high flexural stiffness of these usually large structural parts lead to sandwich construction.

The performance of structural sandwich parts under impact loading has to be considered in many cases. Rail and road vehicles can be exposed to local impacts with small, but possibly heavy objects, for instance stones or ice, and also during the loading and unloading of cargo. Boats and ships can encounter impact loads on the hull in collision with floating objects, when grounding or during manoeuvres in the harbour.

In terms of the usability of such products, ensuring adequate impact strength is crucial because an impact failure, even a local one, may cause severe functional restrictions until the damage is repaired.

The trend towards more advanced, i.e., stiffer and stronger face laminates usually leads to thinner faces in the sandwich. This allows for a further reduction in the structural weight which in turn can yield higher performance, more economical operation or increased payload. However, the impact strength of a laminate is - regardless of material and strength - also dependent on its thickness. Therefore, impact strength becomes an even more critical issue in advanced laminates.

During recent years, considerable research activities have been focused on the issue of FRP-sandwich impact strength. References [1 - 11] show that the research activities in the Nordic countries have been manifold and concerned different industrial branches. However, a common impact-testing method is not in use.

In eight of the above-mentioned references, impact tests have been performed. It is interesting to note that within these references, also eight different test methods have been applied. As the comparison of test results obtained with different methods is nearly impossible, it is obvious that the general knowledge and thereby also the predictability of sandwich impact strength will remain poor as long as no common method is in use.

The need of a common, reliable and comprehensive experimental method is even more emphasised if one takes into account the obvious lack of reliable analytical or numerical prediction methods for sandwich impact strength, specifically if full penetration of the sandwich is of major interest.

The aim of this work is to indicate and elaborate a test method which is comprehensive enough to be able to quantify the impact strength, according to various definitions, of a sandwich and, most importantly, be applicable to sandwich panels of various types and scales.

2 STANDARDISED IMPACT TEST METHODS

A standardised impact test method, developed specifically for sandwich panels, does not exist.

However, there are standardised penetrating impact test methods developed for polymer materials, which in principle can also be applied to sandwich panels. These methods make use of a dropping weight (puncture) test.

Amongst the standardised methods, the most important one is ISO 6603 [12, 13] (Plastics - Determination of multiaxial impact behaviour of rigid plastics; Part 1 : Falling dart method, Part 2 : Instrumented puncture test). The same method is also standardised under DIN and EN standards.

The test method is applicable for rigid plastic specimens of thickness between 1 and 4 mm. However, it is stated that it can be used for specimens thicker than 4 mm, 'if the equipment is suitable, but the test then falls outside the scope of this part of ISO 6603'. The thickness of FRP-sandwich panels is usually considerably greater than 4 mm, but still the equipment can be assumed in principle to be suitable in most of the cases.

The configuration of a test according to ISO 6603 is shown in Figure 1.

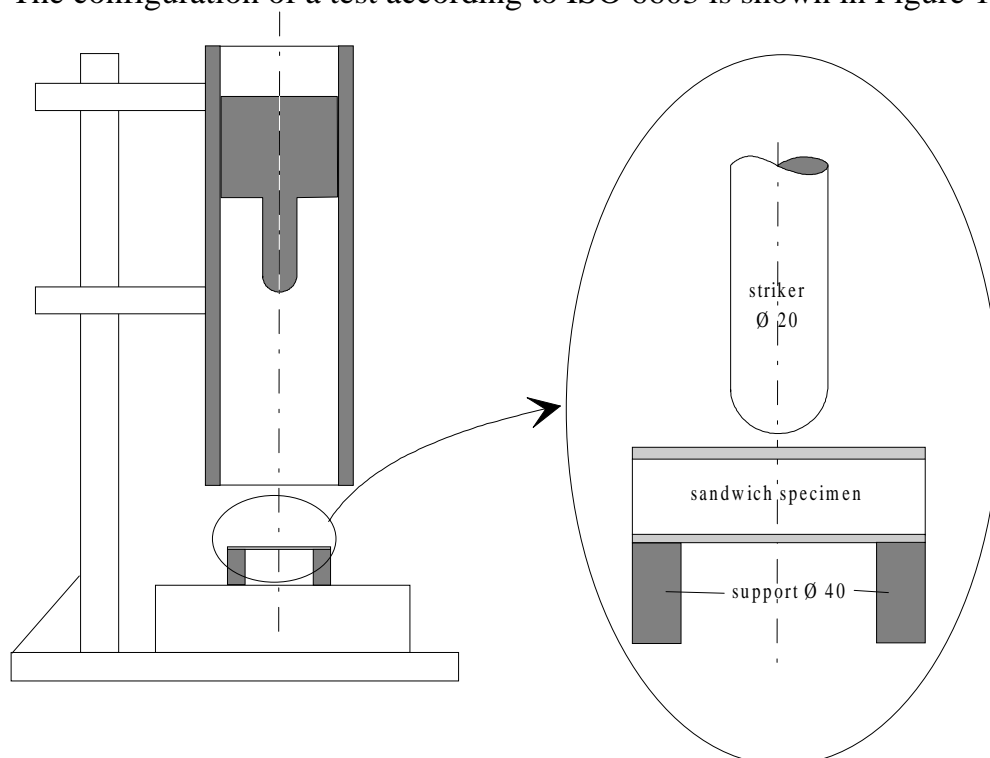

Figure 1. Test configuration in the ISO 6603 standard used with a sandwich specimen.

The preferred size of the test specimen is 60 mm in diameter or 60 mm square.

The specimen support is a hollow steel cylinder with an inside diameter of 40 mm. The test specimen can be clamped onto the support, though the clamping device is optional. In the case of sandwich specimens, the clamping is questionable due to the low transverse stiffness of the specimen.

The striker should have a polished hardened hemispherical striking surface of 20 mm diameter. Alternatively, a smaller striker of 10 mm diameter can be used.

With the instrumented method, the total absorbed energy is calculated from the measured force-time history.

Hence, within the ISO 6603 standardised test method, there are already several possibilities to perform the tests which will lead to different results. The most important allowed variation is the size of the striker which can be either of 10 mm or 20 mm diameter.

3 NON-STANDARDISED IMPACT TEST METHODS

Various non-standardised impact test methods are in use due to the fact that the standardised methods do not in many cases correspond to the impact types expected in the actual structures. Two main reasons for using other than standardised test methods can be identified from references [1 - 11, 14, 15]:

- the size of the impactor used in the standardised methods is too small compared with the total thickness of the sandwich or with probable impactors encountered during the life of the sandwich structure.
- the standardised methods do not cause the desired failure modes observed in failed structures. Desired failure modes can, for instance, be obtained by modifying the shape of the impactor or the angle of incidence.

Most of the methods used are basically modifications of the standardised configurations, the most usual modification being increasing the size and modifying the shape of the impactor [5, 6, 7, 8, 10, 11].

A different type of impact configuration is used in [9] where the test is performed oblique to the specimen at an angle of 35° , as opposed to the 90° of the 'normal' configuration. No instrumentation is used, and therefore the available test results are restricted to the examination of damage type and size. It is, however, emphasised that the test method is not intended to characterise the impact strength of the material or any basic material properties, but to compare the performance relatively to a reference material.

An interesting approach is proposed in [3], in performing the impact test quasi-statically. Actually, a static puncture test is performed, the impactor and support geometry being rather similar to the ISO 6603 standard. The simplification in reducing the loading speed to a quasi-static level appears to be severe, as FRP-faces and most core materials have strain-rate-dependent mechanical properties and additionally, since fracture mechanics might play an important role during a penetrating impact. However, how important these factors are in practice is not entirely clear. In reference [11], the impact force of tests performed quasi-statically was 50-65% lower than that of tests performed dynamically on the same specimens.

The majority of the tests [3,5,6,7,8] is performed with an instrumented apparatus, usually measuring the force during the impact. The recorded force-time data can be post-processed to calculate the total absorbed energy.

The uninstrumented methods [9, 10] do either use an iterative test procedure to determine a specified damage type (for instance penetration) by varying the impact energy, or deduct as a result solely the damage type or area obtained with a certain energy. However, it is important to keep in mind that the damage area is not a valid measure for impact strength, if the total energy absorbed at penetration is of main interest [6]. In this case, impact strength does not correlate with damage area. In order to achieve meaningful results, the iterative methods can require considerably more test specimens than with a comparable instrumented test.

In most of the instrumented test methods, the total absorbed energy is presented as a result. Reference [14] proposes deducting the amount of elastic energy stored in the plate from the total energy in order to obtain the part of energy which is related to the indentation. However, it must be said that if the geometry of the supports is chosen favourably, the elastic energy is usually small and the procedure questionable. Only if the test specimens are flexible can it become important to take the elastic energy into account.

4 DIFFERENT STAGES OF FAILURE OCCURRING DURING A PENETRATING IMPACT

The stages and phenomena which can occur during a penetrating impact between an impactor and a sandwich laminate are extremely complex. This leads to demanding requirements for a comprehensive test method.

Many different strength and stiffness values, and possibly also fracture mechanics, are involved in the penetrating process. However, with experience and engineering judgement, it is possible to isolate certain stages which are likely to occur during a penetrating impact. In order to simplify the problem, two assumptions are made:

It is assumed that the impactor is both stiff and strong compared with the sandwich. Hence, the energy absorption of the impactor is not taken into account. This simplification can be made for many of the critical local impact situations occurring in sandwich structures of vehicles on rail, road and sea, as probable impactor materials can be assumed to be steel, stone or concrete. However, there are possible impact situations where this assumption is not valid, such as in the case of an impact between ice and the sandwich.

Secondly, only the local response of the sandwich is taken into account. It is clear that, when an impact occurs on a sandwich structure, the global response is in many cases significant in terms of total energy absorption and observed impact strength. However, the significance of the global response depends in many cases not only on the impact velocity, but also on the structural response. The structural response is strongly dependent on the location of the impact in respect of local stiffness of the structure. If the impact occurs in the middle of a panel, the panel is, under certain circumstances, able to absorb a considerable amount of elastic energy by bending and shearing. On the other hand, if the impact happens to occur near the edge of a panel, the amount of available elastic energy can be small. Therefore, if the impact location relative to the panel boundaries is randomly distributed, the simplification of omitting the global response can be regarded as the worst case.

The stages possibly occurring during a penetrating impact are shown in Table 1. The basic configuration before the impact is shown in Figure 2, the impactor shape being an example, not an assumption.

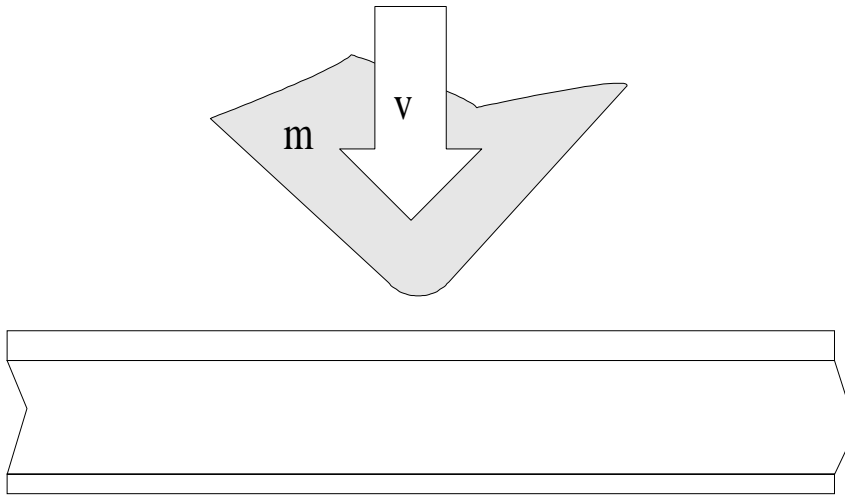
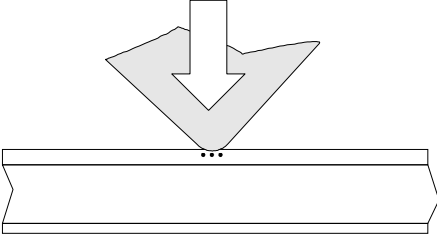
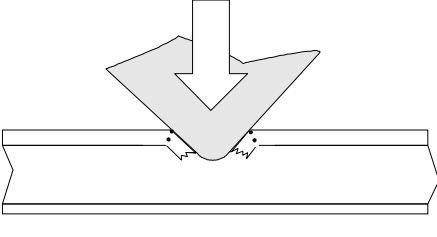
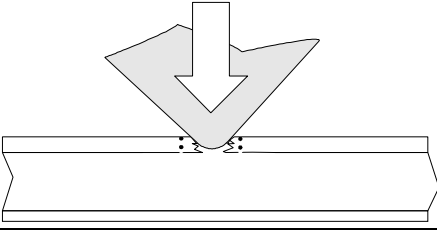
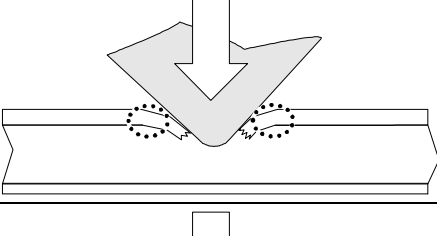
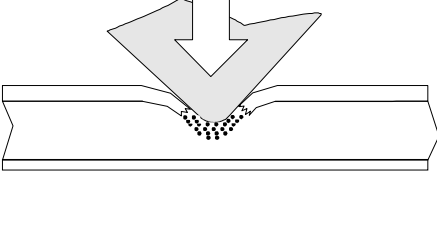
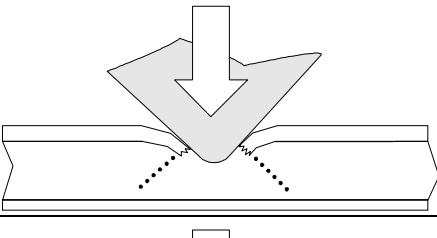
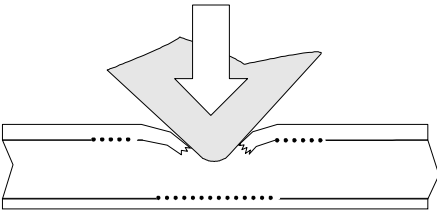

Figure 2. Configuration before an impact between impactor and sandwich.

Whether a certain stage occurs or not depends on many parameters, such as material properties, sandwich geometry and impact configuration. However, all of the stages listed below can possibly occur in certain circumstances. Additionally, the sequence of the stages can vary, again depending on material properties, sandwich geometry and impact configuration.

With a comprehensive sandwich impact test method, it should be possible to cause various failure modes as shown in Table 1. Which of the failure modes are predominant in terms of energy absorption, depends on the impact configuration and sandwich properties. However, it can be regarded as a benefit of the method, if as many modes as possible can be produced during the impact.

Table 1. Stages possibly occurring during a penetrating impact between a hard and strong impactor and a sandwich.

<p>Face crushing (through the thickness) The outer or inner face fails in through-thickness compression under the impactor tip (shown only for outer face).</p>	
<p>Face shear failure The outer or inner face fails locally in interlaminar shear near the sides of the impactor (shown only for outer face).</p>	
<p>In-plane failure of faces The outer or inner face fails in local in-plane tension or compression near the sides of the impactor (shown only for outer face).</p>	
<p>Flexural failure of faces The outer or inner face fails locally in bending near the sides of the impactor (shown only for outer face).</p>	
<p>Core crushing and/or instability (through thickness) The core material is crushed in the thickness direction (compressive failure). This can be in combination with a local compression buckling in honeycomb cores).</p>	
<p>Core shear failure The core fails in shear near the impactor. In brittle core materials, the shear failure can progress over a wide area.</p>	
<p>Delamination between outer face and core and/or inner face and core With certain core materials, delamination between the inner face and core can occur at an early stage</p>	

5 COMPARISON OF TEST METHODS

Three test methods are chosen for the comparison, the standardised test method ISO 6603 (called 'ISO 6603'), the non-standardised test method developed by VTT (called 'pyramid'), using a pyramid-shaped impactor, and the non-standardised test method developed by KTH (called 'slow impact') which uses a quasi-static puncture procedure.

5.1 ISO 6603

Amongst the standardised methods, the puncture test (falling dart) method according to ISO 6603 is widely used and includes procedures for performing both non-instrumented (Part 1) and instrumented (Part 2) tests [12,13].

The shape of the impactor is a cylinder with a hemispherical tip, the diameter of the cylinder is 20 mm. The specimen support is a hollow cylinder with 40 mm internal diameter (Figure 3).

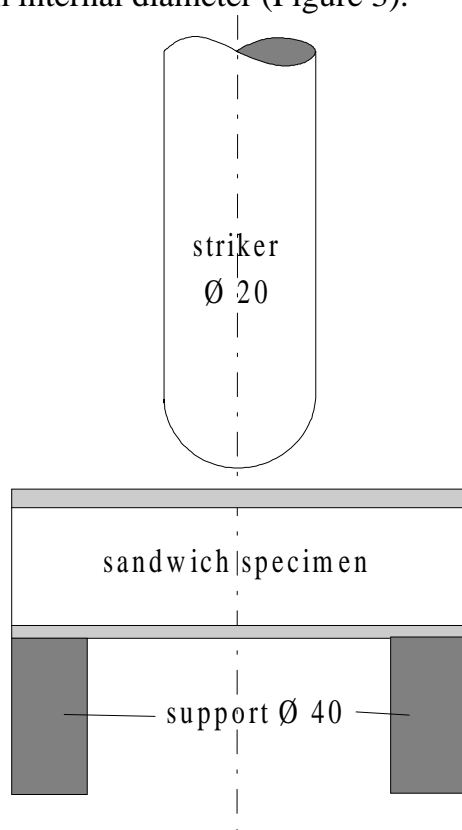

Figure 3. Geometry of the impactor and specimen support in the ISO 6603 method.

As stated in the standard, specimens with thickness greater than 4 mm may be tested, but the test then falls outside the scope of the standard. Sandwich specimens are usually considerably thicker than 4 mm, and hence the results obviously fall outside the standard's scope. However, the equipment is basi-

cally also suitable for thicker specimens, and that may be the reason why the standard has also been used for sandwich specimens.

5.2 PYRAMID

The method has been developed by VTT [14], using a pyramid-shaped impactor. Compared to the ISO 6603 method, there are two main differences:

The impactor is pyramid-shaped. In a penetrating impact through a sandwich, the projected contact area between impactor and sandwich grows with increasing indentation as opposed to the ISO 6603 impactor, in which the projected contact area remains after an initial growth constant. The angle of the pyramid tip has been chosen to correspond to the geometry of an edge, i.e., the pyramid has the same projected contact area as a function of the indentation as has an edge (Figure 4).

The specimen size is at least 250×250 mm, the size of the specimen support being at least 180×180 mm. The specimen is not clamped.

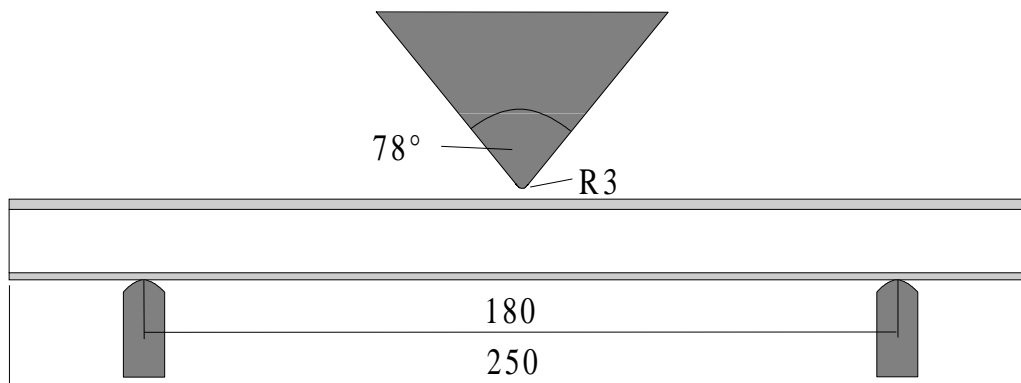

Figure 4. Geometry of the pyramid-shaped impactor and support.

The second difference concerns the post-processing of the results. The response of the test specimen during the test is calculated, and hence, the elastic part of the absorbed energy can be separated from the part related to the indentation. This is important, if flexible test specimen are tested or if panels with different stiffness are to be compared. If the stiffness of the test specimen is high enough, the part of elastic energy is small and the post-processing is optional. The post-processing requires the knowledge of a set of elastic properties of the sandwich specimen.

The effect of the impactor geometry on the results can be seen comparing the results of the 'pyramid' method with the standardised ISO 6603 method.

5.3 SLOW IMPACT

The method is the 'slow impact method' developed at KTH [3]. The method differs in nature from the previous two in the fact that it is actually a quasi-static puncture and not an impact test. The impactor shape (Figure 5) is similar to that in the ISO 6603 method, but the impactor has a smaller diameter of 10 mm. The diameter of the support is 35 mm as opposed to 40 mm in the ISO 6603 standard.

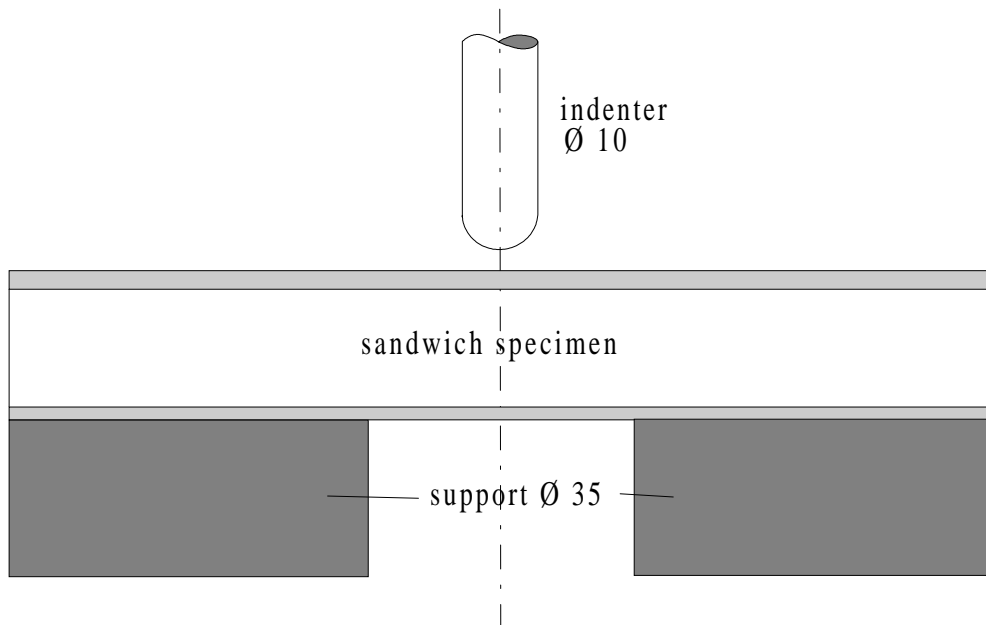

Figure 5. Geometry of the 'slow impact' configuration.

6 TESTED MATERIAL

Nine sandwich panels were tested using the three test methods described in the previous chapter. The lay-up of the specimens is shown in Table 2.

An orthophtalic polyester resin was used for both laminating the faces and bonding them to the core, except in panels 1 and 2, in which the bonding was done with a two-component polyurethane adhesive.

The panels were produced by hand lay-up with vacuum curing which resulted in very uniform face thickness. The measured thickness values of the faces are shown in Table 3.

Table 2. Lay-up of the tested specimens.

	Outer face	Core	Inner face
1	M 300 + 2 × M 450	19 mm EPS 35	2 × M 450
2	M 300 + 2 × M 450 + + 4 mm plywood	19 mm EPS 35	2 × M 450
3	M 300 + 2 × M 450	20 mm PU 45	M 300 + 2 × M 450
4	DBLT 1150	20 mm PU 45	DBLT 1150
5	DBLT 1150	10 mm Divinycell H80	DBLT 1150
6	DBLT 1150	20 mm Divinycell H80	DBLT 1150
7	DBLT 1150	40 mm Divinycell H80	DBLT 1150
8	M 300 + 2 × M 450	20 mm Divinycell H80	M 300 + 2 × M 450
9	M 300 + 2 × M 450	20 mm Airex 63.80	M 300 + 2 × M 450

M 300	continuous mat (glass) 300 g/m ²
M 450	chopped strand mat (glass) 450 g/m ²
DBLT 1150	quadriaxial stitched glass roving 1150 g/m ²
EPS 35	expanded polystyrene 35 kg/m ³
PU 45	polyurethane foam 45 kg/m ³
Divinycell H80	cross-linked PVC-foam 80 kg/m ³
Airex 63.80	linear PVC-foam 80 kg/m ³

Table 3. Measured thickness values of the faces in [mm].

Thickness	1	2	3	4	5	6	7	8	9
Outer face	2.7	6.3	2.1	1.1	1.1	1.0	1.1	2.2	2.0
Inner face	2.0	2.0	2.1	1.1	1.1	1.0	1.1	2.2	2.0

7 RESULTS

The differences between the three test methods are first explained by examining the force-displacement curves recorded during the test. Additionally, typical failure modes which have been obtained with the sandwich specimens are shown.

Due to the nature of a structural sandwich, two typical failure criteria are often used for the determination of impact strength. The first criterion is the penetration of the outer face, the second is the penetration of the inner face, i.e., of the whole sandwich.

Both criteria have been determined in the tests performed with the ISO 6603 and the 'pyramid' methods. In the 'slow impact' method only the criterion of penetration of outer face has been determined. However, the method would allow also determination of the results at penetration of the inner face. Hence, in the ISO 6603 and the 'pyramid' method, the force and absorbed energy are presented at penetration of outer and inner face. In the 'slow impact' method, the force at penetration of the outer face is presented.

7.1 FORCE-DISPLACEMENT CURVES AND FAILURE MODES

7.1.1 ISO 6603

Figure 6 shows a typical force - displacement curve for a sandwich tested according to the ISO 6603 standard. The determination of the points of penetration of the outer and inner face is obviously very easy due to the distinct shape of the curve. The force and energy values at penetration of outer and inner face are marked in the figure.

The force drops immediately after penetration of the outer face and starts rising again when the indenter reaches the inner face. After having penetrated the inner face, the force drops again.

Sandwich test result according to ISO 6603

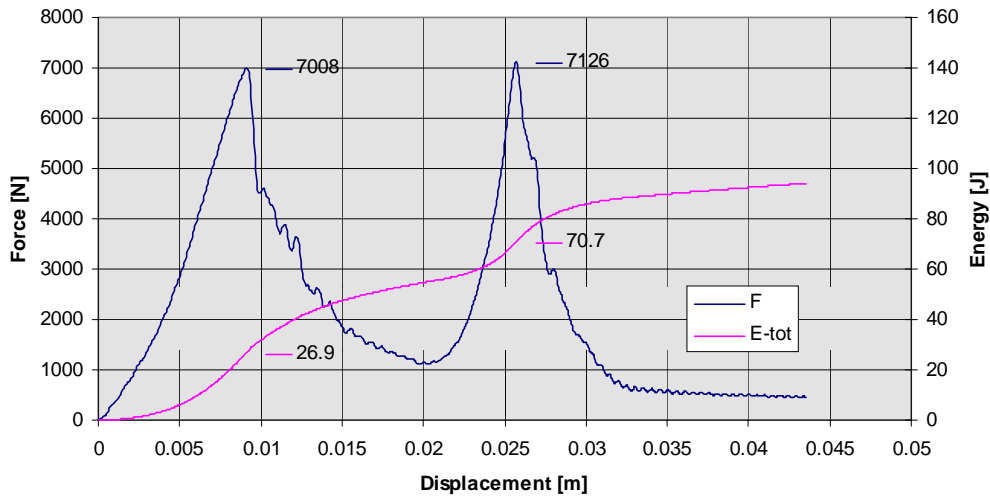

Figure 6. Typical force-displacement curve for a sandwich tested according to ISO 6603. Force and the calculated total energy values are marked at the two maxima, which correspond to penetration of the outer and inner face.

Figure 7 shows a tested specimen from the outer and inner side. The failure is very local and the predominant failure mode is in shear.

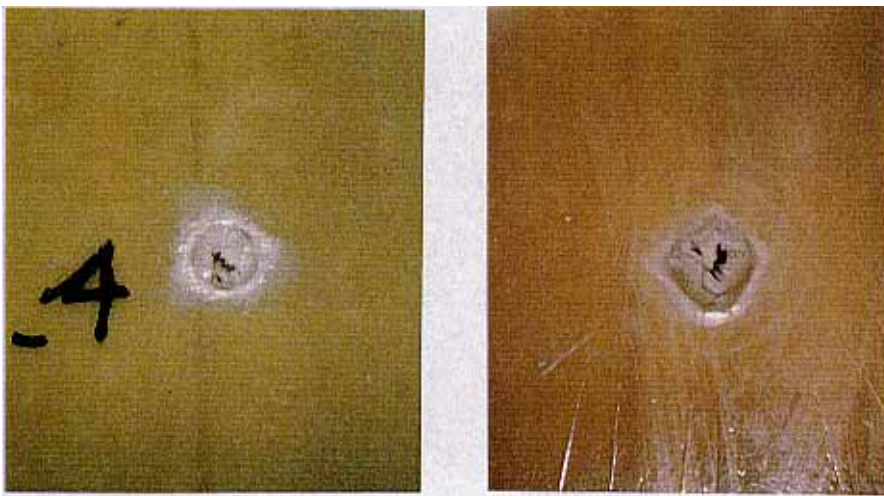

Figure 7. Specimen after an impact test according to ISO 6603. Outer (left) and inner (right) face.

7.1.2 Pyramid

Figure 8 shows a typical result of the 'pyramid' method. The two points at penetration of outer and inner face can be seen in the force curve. The force rises during the test as far as there is enough energy available. At the points of penetration of outer and inner face there is a higher gradient in the force, which can be seen in the Figure.

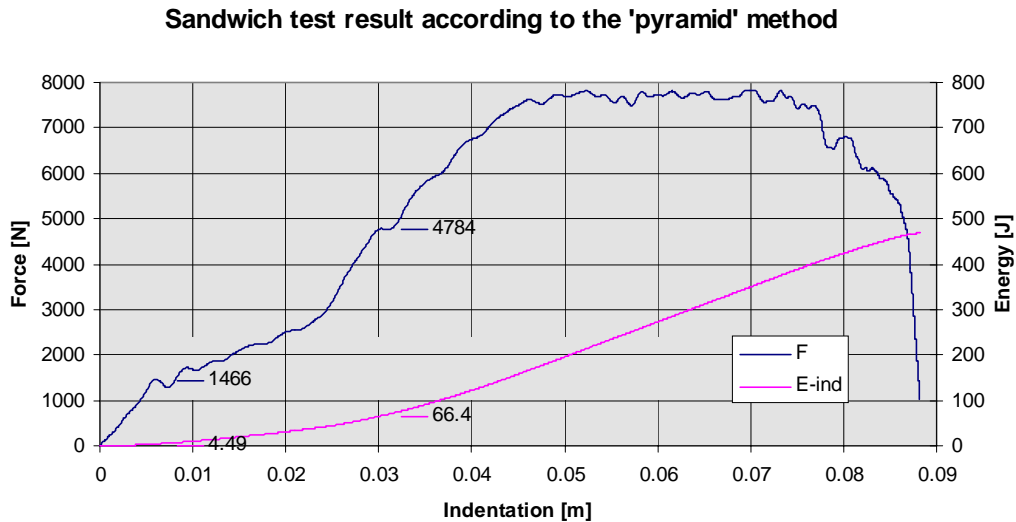

Figure 8. Typical force-indentation curve for a sandwich tested according to the 'pyramid' method. The values of force and energy related to indentation are shown at the points of penetration of the outer and inner face.

Figure 9 shows a sandwich specimen after an impact test performed with the 'pyramid' method. It can be seen that different failure modes have occurred during the test, such as shear, in-plane tension and bending of the faces.



Figure 9. Sandwich specimen after impact with the 'pyramid' method from the outer (top) and inner (bottom) side.

7.1.3 Slow impact

Figure 10 shows a typical result of the ‘slow impact’ method [3].

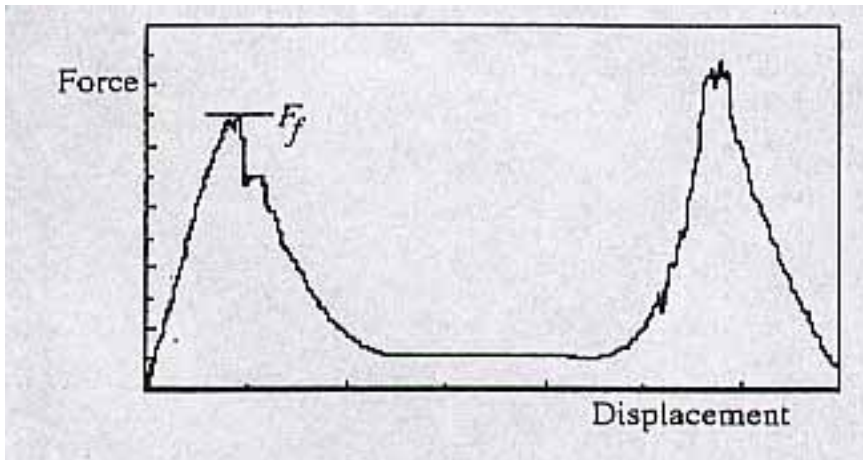

Figure 10. Typical force-displacement curve for a sandwich tested with the ‘slow impact’ method [3]. The force at the first maximum, which corresponds to the penetration of the outer face, is recorded.

7.2 FORCE AND ENERGY AT PENETRATION OF OUTER FACE

Figure 11 compares the force at penetration of the outer face obtained with the three different test methods.

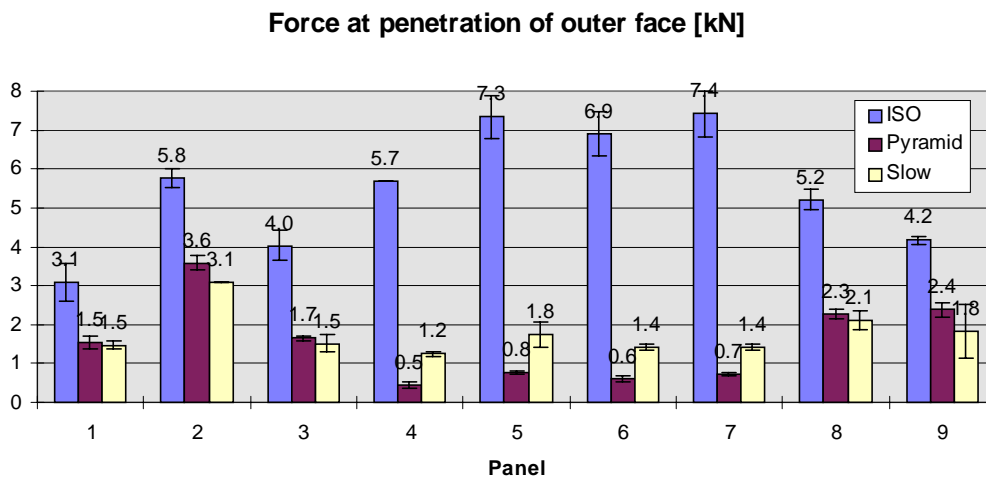

Figure 11. Mean values of force at penetration of the outer face for the three test methods. The error bars indicate the standard deviation.

Figure 12 compares the absorbed energy at penetration of the outer face obtained with the ISO 6603 and the ‘pyramid’ test methods.

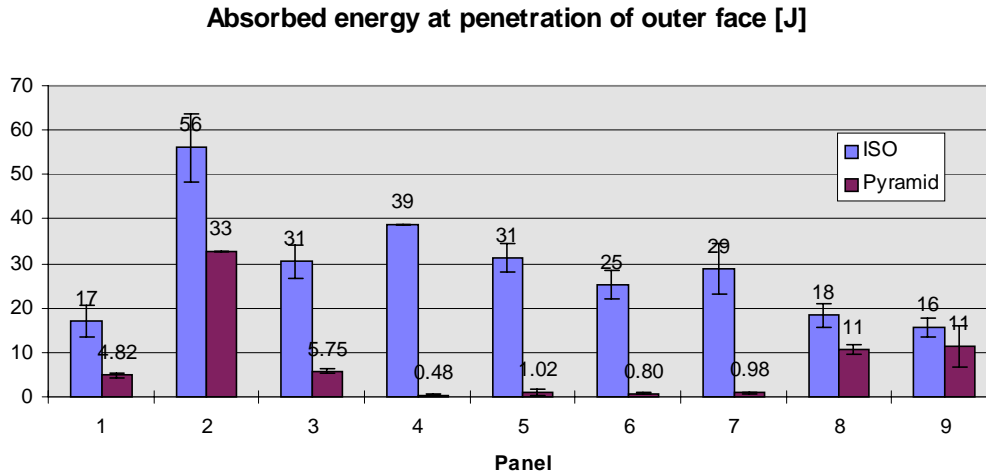

Figure 12. Mean values of absorbed energy at penetration of the outer face for the ISO 6603 and 'pyramid' test method. The error bars indicate the standard deviation.

The comparison of the different test methods can be made in various ways. It is interesting to compare both the absolute and relative values. However, the first observation is the relative level or ranking between the panels. The three methods do not lead to the same ranking in force at penetration of outer face, as can be seen in Figure 13.

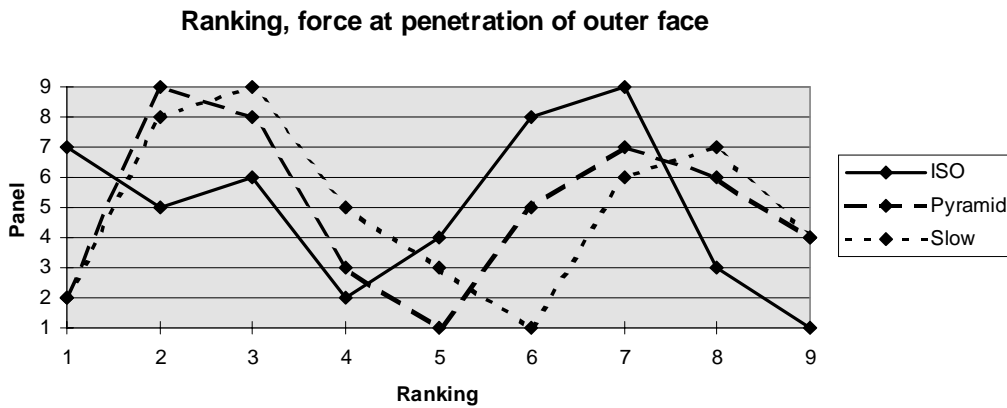

Figure 13. Ranking of the panels, force at penetration of outer face.

However, it is remarkable that the 'pyramid' and the 'slow impact' methods lead to a rather similar ranking.

There are also distinct differences between the level of force between the panels. Figure 14 shows the force levels at penetration of the outer face of the 'pyramid' and 'slow' relative to the ISO 6603 method.

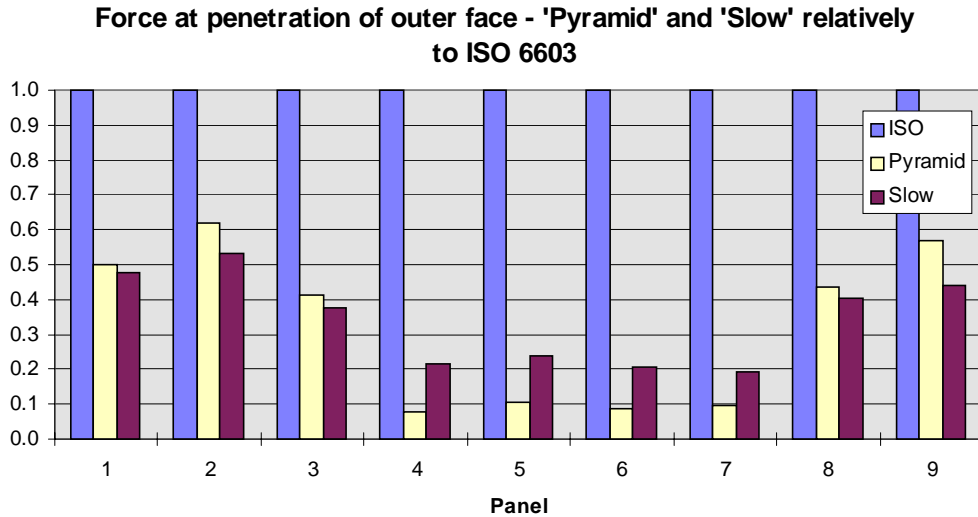

Figure 14. Mean values of force at penetration of outer face measured by the 'pyramid' and 'slow impact' relative to the ISO 6603 method.

It can be clearly seen that the effect of the outer face thickness on the force at penetration of the face is most visible in the 'pyramid' method. This is apparently due to the radius of the impactor tip, which is smallest in the pyramid (R3 as opposed to R5 in the 'slow impact' and R10 in the ISO 6603 method). Hence, the pyramid loads the face more locally than does the impactor in the ISO 6603 method.

Comparing the force values between the 'pyramid' and 'slow impact' methods in Figure 14, it is interesting to see the following: the resulting force level with the two methods in the panels with thicker faces (panel 1, 2, 3, 8, 9) is almost identical, even though the pyramid tip is sharper than the impactor in the 'slow impact' method. In the panels with thinner faces (panels 4-7), the force level with the 'pyramid' method is clearly smaller than with the 'slow impact' method. Apparently, geometric effects lead to these differences, the failure being dominated by face-bending with the thinner face laminates, but by face-shearing in the thicker laminates. It can be assumed that the laminate shear strength, being matrix-dominated, is affected more by varying loading rates than is the laminate flexural strength, which is more fibre-dominated. This is a typical demonstration that the results obtained with different test methods are not even qualitatively comparable.

The speed of loading in the 'slow impact' method was 15 mm/min whereas it was four decades higher in the ISO 6603 and 'pyramid' methods. In reference [11], the effect of different speed of loading on the impact strength was remarkable, dynamic (falling weight) impact tests leading to 2-3 times higher forces at penetration of the outer face than quasi-static ('slow') tests.

The cylindrical impactor with semi-hemispherical tip had a radius of 25 mm. The specimens had PVC cores (80 and 200 kg/m³) of 25 and 50 mm thickness, the glass-polyester face laminates were 1.7 and 3.5 mm thick. The specimen size was relatively large (600×600 mm, specimens simply supported on a 530×530 mm frame). It is obvious that the elastic portion of absorbed energy was remarkable. The level of absorbed energy (penetration of the outer face) was 18 - 62% of the dynamic tests.

7.3 FORCE AND ENERGY AT PENETRATION OF INNER FACE

Unfortunately, the force and energy at penetration of the inner face were not recorded in the ‘slow impact’ method. Therefore, the comparison of these values remains between the ISO 6603 and the ‘pyramid’ test methods.

Figure 15 and 16 compare the force and absorbed energy at penetration of the inner face obtained with the ISO 6603 and the ‘pyramid’ test methods.

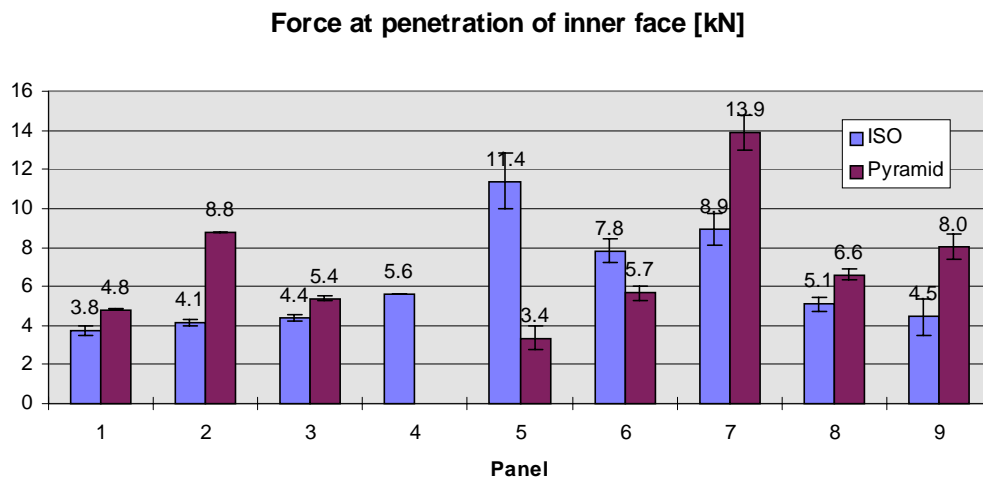

Figure 15. Mean values of force at penetration of the inner face for the ISO 6603 and ‘pyramid’ test method. Error bars indicate the standard deviation.

Absorbed energy at penetration of inner face [J]

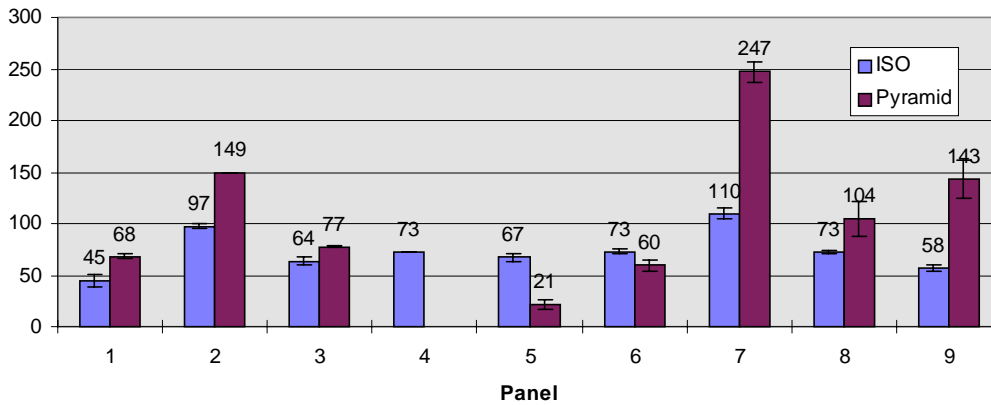

Figure 16. Mean values of absorbed energy at penetration of the inner face for the ISO 6603 and ‘pyramid’ test method. The error bars indicate the standard deviation.

In the ‘pyramid’ test, panel 4 failed totally (total debond between inner face and core) before the inner face was penetrated. In such cases, the values of force and energy can be determined for the point where the total failure occurs as opposed to penetration of the inner face. This criteria may also be of importance in many applications. However, because it is related to a different failure mode, the values cannot be compared. Total debond of the inner face usually occurs only, if the bond strength between core and inner face is low. This failure mode can be avoided by using larger specimen sizes.

The first observation is the relative level or ranking between the panels. As with the penetration of the outer face, the methods do not lead to the same ranking in force or absorbed energy at penetration of inner face, as can be seen in Figure 17 and 18.

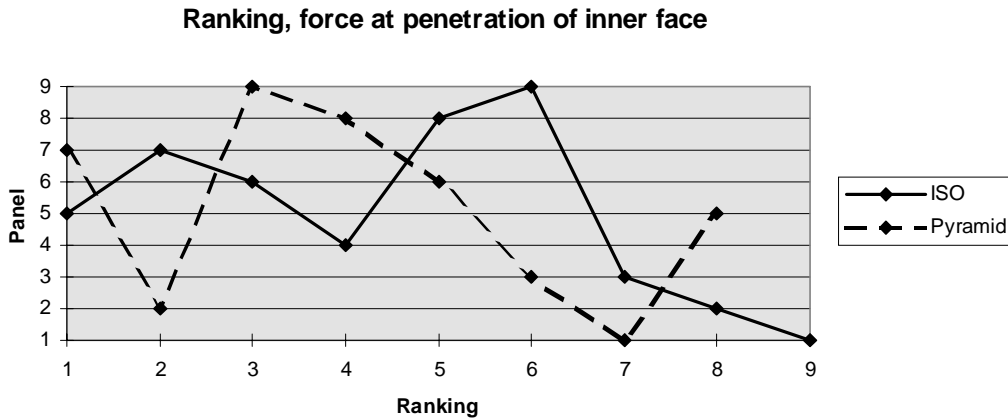

Figure 17. Ranking of the panels, force at penetration of inner face.

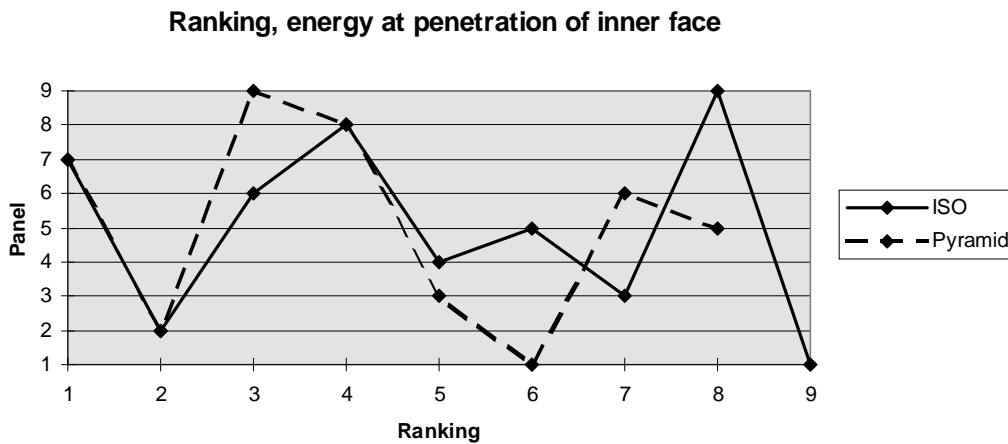

Figure 18. Ranking of the panels, absorbed energy at penetration of inner face.

There are again remarkable differences in the ranking. For example, panel 5 has the highest force at penetration of the inner face according to ISO 6603, but according to the ‘pyramid’ method the lowest of all the panels.

The effect of core thickness on the impact strength at penetration of inner face is small in the ISO 6603 method, due to the impactor shape. With a cylindrical impactor, the test ‘forgets’ the outer face after having penetrated it. Because of the increasing projected contact area, the pyramid-shaped impactor causes failure in the outer face also after its penetration. This can clearly be seen when comparing the results of panels 5, 6 and 7, but also in panel 2, which has a plywood reinforcement in the outer face.

With a cylindrical impactor shape, not only the effect of core thickness, but also of core material is almost ignored. This can be seen when comparing panel 3, 8 and 9, which have the same face laminates but a different core

material. In the ISO 6603 method, the force and absorbed energy values at penetration of the inner face are of the same level. The same observation can be made in reference [15] where the impact strength of sandwich panels with different PVC and end-grain balsa cores has been compared. The 1.6 mm-thick faces were of glass-epoxy, the core thickness was 20 mm. A falling weight test with a cylindrical impactor with semi-hemispherical tip (7 mm radius) was used and the conclusions were that the core has very little influence on the perforation resistance of the sandwich.

The 'pyramid' method clearly indicates that the stronger and tougher core materials lead to greater impact strength.

8 CONCLUSIONS

Based on the present series of nine different sandwich panels tested with three different test methods, the following conclusions can be made:

- The test results obtained with the different methods lead to a different impact strength ranking of the panels for both of the used failure criteria (penetration of outer and inner face). Hence, the results obtained with different test methods are not even qualitatively comparable.
- The *impactor geometry* greatly affects the nature of the impact and the possible failure modes. If the projected contact area grows with indentation ('pyramid'), the nature of penetration is completely different than with a constant area. This mostly affects the results at penetration of the inner *face* as the pyramid-shaped impactor does not 'forget' the outer *face* after having penetrated it.
- Due to the *constant projected contact area* of cylindrical impactor heads, both core thickness and core material have very little influence on the impact strength.
- The *impactor tip radius* affects the force and energy at penetration of the outer face. The smaller the radius, the smaller the force and energy at penetration of outer face. With the 'pyramid' method, it can become difficult to reliably determine the point of penetration of outer face, if the force level is very small.
- Cylindrical impactor types, as used in the ISO 6603 method, cause *failure modes* that are shear-dominated as opposed to the 'pyramid' method, which provokes manifold failure modes.
- Differences in *speed of testing* (quasi-static vs. impact) can affect the impact strength in different manners, depending on which is the dominating strength value involved in the failure mode.
- The *post-processing of the indentation* (vs. displacement) is important if the flexural and shear stiffness of the specimens is small, or if panels of different stiffness are to be compared. Often, sandwich specimens are stiff enough and the amount of elastic energy is small. In the present test series, the elastic energy at penetration of the inner face was below 5% of the total energy.
- In the 'pyramid' method, the penetration of the inner face is not obtained, if the inner *face* debonds completely before being penetrated. This failure

mode can be avoided by increasing the size of the test specimen. In certain applications, the ability of a sandwich to produce large delamination of the inner face under potentially penetrating loads does act like a massive strength reserve. In other cases, the point of total debond can be taken as the criterion, as opposed to penetration of the inner face.

- The weakest point of the ‘pyramid’ method is the fact that the peaks at penetration of outer and inner face are small if the face thickness is low. In these cases, a modified pyramid with a larger tip radius would produce more easily readable results. However, it is important to remember that a small radius is more critical for the sandwich panels. Therefore, the radius should correspond to the smallest one found in potential impactors of the actual sandwich structures.
- Since the ‘pyramid’ method is able to provoke a multitude of different failure modes, and additionally is able to provide consistent results at penetration of both outer and inner face, it is considered to be of most practical and general value for determining the impact strength of FRP-sandwich structures.

9 ACKNOWLEDGEMENTS

This work has been financed by NORDTEST which is gratefully acknowledged by the author.

The author would like to express his thanks to Dr. Joachim Grenestedt, KTH, for performing the 'slow impact' tests and for the various fruitful discussions.

REFERENCES

- 1 Gaarder, R. H. 1995. Methods to predict impact performance of sandwich structures. Espoo: Nokos Second Composites and Sandwich Meeting, 4.-5. 4. 1995. Pp. 25-27.
- 2 Brevik, A. F. 1995. Sandwich constructions for subsea applications. Presented at the third international conference on sandwich construction. 9 p.
- 3 Grenestedt, J. & Kutenkeuler, J. 1995. Slow impact on Sandwich panels. Espoo: Nokos Second Composites and Sandwich Meeting, 4.-5. 4. 1995. Pp. 35-37.
- 4 Olsson, R. 1995. Prediction of impact damage in sandwich panels. Presented at the third international conference on sandwich construction. 10 p.
- 5 Lönnö, A. & Håkanson, P. 1995. Development of a super tough FRP-sandwich concept for the 10.8 m combat craft 90E. Presented at the third international conference on sandwich construction. 12 p.
- 6 Hildebrand, M. 1994. The effect of raw-material related parameters on the impact strength of sandwich boat-laminates. Espoo, Technical Research Centre of Finland, VTT Publications 211. 36 p. + app. 19 p.
- 7 Auerkari, P. & Pankakoski P. H. 1995. Strength of sandwich panels with impact defects. Espoo: VTT Technical Report VAL B 75. 19 p. + app. 4 p.
- 8 Burchardt, C., et al. 1993. Slagpåvirkning af sandwichplader. Aalborg: M.Sc. Thesis, Aalborg Universitets Center. 90 p. + app. 82 p.
- 9 Aamlid, O. 1995. Oblique impact testing of aluminium - and composite panels. Hovik: Det Norske Veritas Research, Technical Report No. 95-2042. 36 p.
- 10 Marum, S.E. 1993. Impact testing of GRP/PVC sandwich panels (In Norwegian). Mandal: Kvaerner Mandal test report EO 094. 23 p. + app. 49 p.

- 11 Nilsen, P.E., Moan, T., Gustafson, C.-G. 1992. Dynamic and quasi-static indentation of PVC/GRP sandwich plates. Warley: Proceedings of the second international conference on sandwich construction. EMAS. Pp. 121 - 137.
- 12 ISO 6603/1-1985. Plastics - Determination of multiaxial impact behaviour of rigid plastics - Part 1: Falling dart method.
- 13 ISO 6603/2-1989. Plastics - Determination of multiaxial impact behaviour of rigid plastics - Part 2: Instrumented puncture test.
- 14 Kivelä, J. 1992. Veneen kerroslevyrakenteen paikallislujouden määrittäminen. [The determination of local impact strength for small-craft sandwich structures]. Espoo: Helsinki University of Technology. M.Sc. Thesis. 62 p. + app. 19 p.
- 15 Cantwell, W.J, Dirat, C. & Davies, P. 1994. A comparative study of the mechanical properties of sandwich materials for nautical construction. SAMPE Journal, Vol. 30, No. 4, pp. 45-51.

TEST RESULTS

Panel and test method	Force at penetration of outer face	Absorbed energy at penetration of outer face	Force at penetration of inner face	Absorbed energy at penetration of inner face
	[kN]	[J]	[kN]	[J]
1 ISO	3.08 ± 0.48	17.0 ± 3.5	3.76 ± 0.24	44.7 ± 5.6
Slow	1.47 ± 0.15			
Pyramid	1.54 ± 0.10	4.82 ± 0.46	4.82 ± 0.05	68.2 ± 2.6
2 ISO	5.77 ± 0.23	56.0 ± 7.5	4.14 ± 0.13	97.3 ± 2.2
Slow	3.07 ± 0.18			
Pyramid	$3.58 \pm *$	$32.7 \pm *$	$8.77 \pm *$	$149 \pm *$
3 ISO	4.03 ± 0.38	30.5 ± 3.7	4.41 ± 0.17	63.6 ± 4.1
Slow	1.52 ± 0.06			
Pyramid	1.66 ± 0.23	5.75 ± 0.47	5.38 ± 0.11	77.0 ± 0.7
4 ISO	$5.70 \pm *$	$38.8 \pm *$	$5.58 \pm *$	$72.8 \pm *$
Slow	1.24 ± 0.07			
Pyramid	0.45 ± 0.05	0.48 ± 0.07	$4.45 \pm 0.36^{**}$	$68.4 \pm 7.3^{**}$
5 ISO	7.33 ± 0.54	31.1 ± 3.2	11.4 ± 1.4	67.1 ± 4.4
Slow	1.76 ± 0.05			
Pyramid	0.77 ± 0.33	1.02 ± 0.61	3.37 ± 0.64	21.0 ± 4.7
6 ISO	6.90 ± 0.56	25.2 ± 3.2	7.83 ± 0.58	73.0 ± 1.7
Slow	1.44 ± 0.08			
Pyramid	0.60 ± 0.08	0.80 ± 0.12	5.65 ± 0.39	59.7 ± 5.3
7 ISO	7.42 ± 0.58	28.7 ± 5.7	8.92 ± 0.80	110 ± 6
Slow	1.42 ± 0.04			
Pyramid	0.72 ± 0.08	0.98 ± 0.13	13.9 ± 0.9	247 ± 10
8 ISO	5.21 ± 0.26	18.3 ± 2.5	5.09 ± 0.39	73.0 ± 1.6
Slow	2.10 ± 0.11			
Pyramid	2.28 ± 0.25	10.7 ± 1.0	6.60 ± 0.28	104 ± 17
9 ISO	4.17 ± 0.10	15.6 ± 2.1	4.45 ± 0.93	57.5 ± 3.0
Slow	1.83 ± 0.19			
Pyramid	2.38 ± 0.70	11.4 ± 4.6	8.01 ± 0.65	143 ± 18.2

* only one specimen

** total debond between inner face and core, no penetration of inner face. The values are at the point of total debond.