

Isabel Pinto

Raw material characteristics of maritime pine (*Pinus pinaster* Ait.) and their influence on simulated sawing yield



HELSINKI UNIVERSITY OF TECHNOLOGY
Department of Forest Products Technology



Forest Research Center
Institute of Agriculture
Technical University of Lisbon



Raw material characteristics of maritime pine (*Pinus pinaster* Ait.) and their influence on simulated sawing yield

Isabel Pinto

VTT Building and Transport

*Dissertation for the degree of Doctor of Science in Technology
to be presented with due permission of the Department of Forest Products
Technology for public examination and debate in Auditorium P1
at Helsinki University of Technology (Espoo, Finland)
on the 3rd of November, 2004, at 13 o'clock.*



ISBN 951-38-6373-5 (soft back ed.)

ISSN 1235-0621 (soft back ed.)

ISBN 951-38-6374-3 (URL: <http://www.vtt.fi/inf/pdf/>)

ISSN 1455-0849 (URL: <http://www.vtt.fi/inf/pdf/>)

Copyright © VTT Technical Research Centre of Finland 2004

JULKAISIJA – UTGIVARE – PUBLISHER

VTT, Vuorimiehentie 5, PL 2000, 02044 VTT

puh. vaihde (09) 4561, faksi (09) 456 4374

VTT, Bergsmansvägen 5, PB 2000, 02044 VTT

tel. växel (09) 4561, fax (09) 456 4374

VTT Technical Research Centre of Finland,

Vuorimiehentie 5, P.O.Box 2000, FIN-02044 VTT, Finland

phone internat. + 358 9 4561, fax + 358 9 456 4374

VTT Rakennus- ja yhdyskuntatekniikka, Betonimiehenkuja 5, PL 1806, 02044 VTT

puh. vaihde (09) 4561, faksi (09) 456 7027, (09) 456 7066

VTT Bygg och transport, Betongblandargränden 5, PB 1806, 02044 VTT

tel. växel (09) 4561, fax (09) 456 7027, (09) 456 7066

VTT Building and Transport, Betonimiehenkuja 5, P.O.Box 1806, FIN-02044 VTT, Finland

phone internat. + 358 9 4561, fax + 358 9 456 7027, + 358 9 456 7066

Technical editing Leena Uksskoski

Otamedia Oy, Espoo 2004

Pinto, Isabel. Raw material characteristics of maritime pine (*Pinus pinaster* Ait.) and their influence on simulated sawing yield. Espoo 2004. VTT Publications 533. 51 p. + app. 69 p.

Keywords maritime pine, *Pinus Pinaster* Ait., 3D stem models, stem shape, knots, heartwood, sapwood, sawing simulation, production yields

Abstract

The objective of this work was to study maritime pine (*Pinus pinaster* Ait.) wood characteristics and their impact on the sawing yield using virtual stem models and sawing simulation procedures. In the first part of the work, a characterisation of maritime pine as raw material for the wood industry was performed. The stem shape, distribution of knots, and heartwood/sapwood contents were studied. In the second part of this work, the virtual stems provided the raw material for sawing-simulation studies.

The stem reconstruction, bucking, and sawing simulation modules of WoodCIM® were used. WoodCIM® is an integrated optimising software system, developed at the Technical Research Centre of Finland (VTT), for the optimisation of the wood conversion chain. The software was adapted for maritime pine and validated. Thirty five maritime pine stems were randomly sampled from 4 sites in Portugal. These were mathematically reconstructed into virtual stems, based on image analysis of flitch surfaces. The 3D virtual stems included the description of external shape, internal knot architecture, and heartwood core. The reconstruction of the heartwood shape was a new feature added to the reconstruction module during this study. Input data concerning final products and process variables for sawing simulation were obtained directly from the wood-based industry.

The average volume percentage of knots in 83 year-old maritime pine trees, varied from 0.07% for butt logs to 1.95% for top logs. Heartwood diameter either followed the stem profile or showed a maximum value at the height 3.8 m, on average, while sapwood width was higher at the stem base and after 3 m remained almost constant along the stem height. Production yields were higher for logs with origin of the first half of the stem as diameters were large and taper reduced when compared with top logs. Butt logs showed the highest value yields because of the knot core profile. When the target was to maximise the production of heartwood containing components, best yields were obtained with logs bucked between 3 and 9 m height.

The results in this study increased the basic scientific knowledge about maritime pine concerning the variations of wood characteristics and their influence on sawing yield outputs. Also, these can contribute to further development of industrial applications of defect detection and sawing simulation tools.

Pinto, Isabel. Raw material characteristics of maritime pine (*Pinus pinaster* Ait.) and their influence on simulated sawing yield. [Características da madeira de pinheiro bravo (*Pinus pinaster* Ait.) como matéria-prima e influência nos rendimentos em serração obtidos por simulação da conversão]. Espoo 2004. VTT Publications 533. 51 p. + app. 69 p.

Palavras chave Pinheiro bravo, *Pinus pinaster* Ait, geometria do tronco, nós, borne, cerne, simulação da serração, rendimentos de produção

Resumo

O conhecimento das propriedades da madeira, enquanto matéria-prima industrial, e de como a transformar de forma a responder com eficiência às necessidades do mercado, é essencial para a optimização da cadeia de conversão da madeira. O aumento de competitividade do sector madeireiro em Portugal passa por uma modernização tecnológica e uma especialização da mão-de-obra, pela aposta na reflorestação e condução silvícola dos povoamentos com vista a obter produções sustentadas e madeira de boa qualidade e, principalmente, pela aposta na produção de produtos de qualidade com um elevado valor acrescentado. Para tal é necessária uma análise global da cadeia de conversão da madeira, desde a floresta ao produto final (Figura 1). Num extremo da cadeia encontra-se uma matéria-prima de elevada variabilidade e no outro os consumidores com especificações crescentes em termos de qualidade dos produtos finais. Neste sentido, os recentes desenvolvimentos de técnicas de modelação e programas de simulação surgem como uma ferramenta útil em vários níveis da cadeia de conversão. Estes programas permitem não só um aumento rápido de conhecimentos sobre a matéria prima e uma modelação da sua formação como também uma previsão das propriedades dos produtos serrados antes da operação de serração.

O presente trabalho visa aumentar o conhecimento sobre as características da madeira de pinheiro bravo (*Pinus pinaster* Ait.) e a influência destas nas suas utilizações finais. O trabalho é desenvolvido através de modelação da qualidade e geometria do tronco e de simulação da sua conversão. O pinheiro bravo é a principal espécie em Portugal, correspondendo a cerca de 30% do território florestal nacional, e a maior fornecedora de matéria-prima para a indústria de serração. Os resultados apresentados foram obtidos através da adaptação a esta espécie dos módulos de reconstrução virtual do tronco, toragem e simulação da serração do programa WoodCIM®, desenvolvido no VTT – Technical Research Centre of Finland. O programa WoodCIM® integra a simulação de vários estágios da transformação da madeira com vista à optimização da sua cadeia de conversão. Os resultados obtidos foram compilados em cinco publicações científicas listadas na secção "list of publications".

Na primeira parte construiu-se um banco de troncos virtuais gerados através da análise de imagem de varrimentos de tábuas e utilizaram-se algoritmos para a reconstrução de toros e troncos. Com base na informação gerada por estes modelos virtuais dos troncos foi feita uma caracterização da madeira de pinheiro bravo enquanto matéria-prima para a indústria de serração. Foram estudados a forma do tronco, a distribuição e dimensões dos nós internos e os conteúdos de

borne e cerne (Estudos I e II). A selecção das características a estudar foi feita com base no seu impacto na qualidade dos productos finais. Foram também analisadas as diferenças entre o modelo e a realidade.

Na segunda parte do trabalho, estes troncos virtuais foram utilizados como matéria-prima de entrada para os programas de simulação da toragem e da serração. O Estudo III explorou as potencialidades do programa de simulação WoodCIM® para investigar o impacto das características da matéria-prima na conversão do pinheiro bravo. No Estudo IV, os resultados gerados pelo programa foram validados em relação a dados obtidos em ambiente industrial. Por fim, o Estudo V usou os modelos desenvolvidos e o programa de simulação para estudar os potenciais de produção de productos de cerne a partir da madeira desta espécie.

Em Portugal foram amostradas 35 árvores em quatro locais dentro da área de distribuição do pinheiro bravo: Leiria (S1), Mação (S2), Alpiarça (S3) e Marco de Canavezes (S4). As árvores foram cortadas em toros de 2,5 e 5 m e estes serrados em pranchas, enviadas para a Finlândia. Através da utilização do sistema de inspecção e aquisição de imagens WoodCIM® – foi feito o varrimento de todas as pranchas. As imagens obtidas, em formato bitmap (RGB), foram transferidas para o programa Puupilot onde foram registadas as coordenadas geométricas de cada prancha e de todos os defeitos. O programa mostra a imagem da prancha no monitor e é assistido por um operador. Deste modo constitui-se uma base de dados com todas as coordenadas geométricas de cada prancha e de todos os defeitos que, posteriormente, servirá de base à reconstrução tridimensional dos toros e troncos (por junção dos toros reconstruídos). O modelo virtual do tronco inclui uma representação tridimensional da sua geometria, da arquitectura dos nós internos e da geometria do cerne (Figura 3). A reconstrução do volume de cerne constitui uma nova função adicionada ao programa de reconstrução que foi desenvolvida no âmbito do presente trabalho (Estudo II). Para a simulação da serração destes troncos virtuais, os dados relativos ao processo de conversão e à qualidade, dimensões e preços dos productos serrados foram obtidos por informação da Indústria Portuguesa de serração.

Os resultados mostram que, em árvores de 83 anos, o volume médio de nós relativamente ao volume total do toro varia de 0,07% nos toros de base até 1,95% nos toros do topo. O núcleo nodado varia de 28% do raio do tronco na sua base até 83% a 70% da altura total da árvore. Nestas árvores mais velhas, o cerne representa 17% do volume até 50% da altura da árvore, enquanto que em árvores mais jovens (42–55 anos) esta proporção é de cerca de 12–13%. A idade de formação do cerne foi estimada em 13 anos, com uma taxa de transformação do borne em cerne de 0,5 e 0,7 anéis por ano para árvores com, respectivamente, idades inferiores ou superiores a 55 anos. A evolução do diâmetro de cerne com a altura da árvore apresenta dois padrões distintos: ou seguindo o perfil do tronco, ou apresentando um máximo a cerca de 3,8 m de altura, em média (Figura 8). Por outro lado, a largura de borne é maior na base do tronco diminuindo até cerca de 3 m de altura, após o que permanece quase constante ao longo do tronco. Devido ao seu diâmetro superior e à reduzida conicidade, os

toros obtidos na primeira metade do tronco apresentaram os rendimentos de conversão mais elevados em todas as simulações, especialmente quando o alargamento do tronco na base foi evitado. Os toros de base apresentaram também os rendimentos em valor mais elevados devido ao seu reduzido núcleo enodado. No entanto, para a maioria das árvores, quando o objectivo é maximizar a produção de componentes serrados contendo cerne, foram os toros com origem entre 3 e 9 m da altura do tronco que apresentaram os melhores rendimentos. Demonstrou-se que existe potencial para a produção de produtos de cerne de pinheiro bravo desde que se desenvolvam esforços adicionais na selecção da qualidade da matéria prima e também na selecção dos produtos serrados. Esta produção de produtos de cerne terá sempre de ser integrada com os restantes produtos serrados do borne.

Os módulos do programa WoodCIM® que foram adaptados ao pinheiro bravo neste trabalho (reconstrução virtual dos troncos, toragem e simulação de serração) mostraram poder ser ferramentas úteis para a investigação das características da madeira desta espécie e para a optimização dos seus usos finais em serração. Os resultados contribuem para o aumento do conhecimento sobre a variabilidade das características da madeira de pinheiro bravo e a sua influência na qualidade dos produtos finais. Para além do conhecimento científico, os resultados poderão contribuir para o futuro desenvolvimento de aplicações industriais dos sistemas de modelação e simulação aqui testados.

Preface

This thesis was carried out in the Technical Research Centre of Finland, VTT – Building and Transport in collaboration with the Centre for Forest Studies, Technical University of Lisbon. The thesis was developed for the degree of Doctor of Science in Technology from the Forest Products Technology Department, Helsinki University of Technology. Financial support was given by a Doctoral scholarship from Portuguese Foundation for Science and Technology (FCT) and grants from the Research Foundation of Helsinki University of Technology and the Foundation of Technology (TES). Part of the work was carried out under the research programme PAMAF 8185, financed by INIA (Instituto Nacional de Investigação Agrária, Portugal) and support by a Marie Curie Research Training Grant.

I want to express my sincere gratitude to Professor Helena Pereira and Dr Arto Usenius, my instructors, who directed my research wisely in all steps of this work and also for their support and encouragement through all the time. Having the possibility of sharing their different expertise areas and background experience was, without doubt, a very important contribution to my professional development.

I also thank my supervisor on behalf of the Department of Forest Products Technology, Professor Tero Paajanen for all the guidance during my studies and most useful comments and suggestions on my work. His practical mind and support were most valuable at critical phases of this thesis.

It has been a pleasure to work with my co-authors Eng. Sofia Knapic and Lic.Tech. Tiecheng Song. I wish to thank Lic.Tech. Song for all the alterations to the sawing simulation program and for his infinite patience while teaching me all the steps of it. I thank Eng. Knapic for helping me with her practical mind and most valuable friendship. It was a pleasure to share the long working days and nights, full of good humour and lots of tea and biscuits.

I owe my sincere thanks to everyone in VTT Building and Transport (former VTT Building Technology) for hosting me, sharing their expertise during these years, and making this thesis possible. Especially I would like to thank those with whom I had the pleasure of working more closely with: Antti Heikkilä, Jorma Fröblom, Timo Usenius, Olof Sommardahl, Eero Halonen, Pirjo Kari, Kari Niittylä, Heikki Murto, Tapio Kanko, and Pasi Hemmilä. And also those who had to work close with me sharing the same office space: Unto Vassara, Marta Margarido, Sofia Knapic, Leena Suomi-Lindberg, Sini Metsä-Kortelainen, and especially Juha Mikkola, my Suomi teacher. Kiitos kaikille!

I would like to thank everyone in the Centre of Forest Studies, ISA – Technical University of Lisbon where I gave my first steps in research. Thanks to the friends and colleagues that never stop helping me in different phases of this

work even when I have been so long and so far away. Special thanks to Dr. Jorge Gominho and Dr. Paula Soares.

Also, I owe my thanks to all the Professors and Researchers at the Wood Laboratory of the Forest Products Technology Department, Helsinki University of Technology for all the support and feedback during my studies and the execution of this thesis. I am especially grateful to Lic.Tech. Jussi Virtanen with whom I had fruitful discussions and Ms. Eeva Alho for all the practical help.

I am grateful to Professor Fátima Tavares and Professor Anders Grönlund for all the constructive comments given during the pre-examination of my thesis.

Thanks are due to the Portuguese National Forest Service (Direcção Regional Agrária da Beira Litoral) and to Sonae Indústria and AJI Serração, who supplied the trees and, in the last case, supported the industrial study. Thanks also to the Industries and Institutions that supplied me with data and technical help in various stages of this work: ASilva&Silva, Cerne, Alberto Gaspar, AIMMP, Metla, and Häme Polytechnic, Evo – Degree Programme in Forestry.

I would like to thank Dr Erika Holt for the valuable linguistic corrections to this thesis and for her cheerful friendship since my first times at VTT.

Also, I which to thank my colleagues who supported me in the sampling field work and data collection: Vanda Oliveira, José Pedro Frenandes, Sofia Knapic, Diogo Baptista, Marta Margarido, José Manuel Pires, and António Glória.

To all my friends in Portugal, Finland, and a bit all over the world my thanks for the support and for making my life so colourful. And to the LTL "aivo-social group", thank you for adopting me so many times. Especially, I am greatly indebted to Cristina Simões, my dearest friend with whom I shared so many unforgettable moments during these years in Helsinki.

I owe my warmest thanks to my beloved family for believing in me and for giving me the courage to stay so far from home. Thank you for your endless love that helped me so much in reaching my goals. Muito obrigada por todo o vosso apoio!

Finally, I would like to thank Mika Seppä for all the love that he brought into my life and for all the support and encouragement during the finalization of this thesis.

I want to dedicate this thesis to the memory of my father, António Raul Teixeira Pinto, who taught me that nothing in life is granted without risks and loads of work!



Helsinki, September 2004

List of publications

This thesis is based on the following publications which are referred to in the text by Roman numerals I–V:

- I **Pinto I.**, Pereira H. and Usenius A. (2003) Analysis of log shape and internal knots in twenty maritime pine (*Pinus pinaster* Ait.) stems based on visual scanning and computer aided reconstruction. *Ann. For. Sci.* 60: 137–144.
- II **Pinto I.**, Pereira H. and Usenius A. (2004) Heartwood and sapwood development within maritime pine (*Pinus pinaster* Ait.) stems. *Trees* 18(3): 284–294.
- III **Pinto I.**, Pereira H. and Usenius A. (2002). Sawing simulation of *Pinus pinaster* Ait. IUFRO WP S5.01.04 “Connection between forest resources and wood quality: modelling approaches and simulation software”. British Columbia, Ed. G. Nepveu, INRA, Nancy: 429–438.
- IV **Pinto I.**, Knapic S., Pereira H. and Usenius A. Simulated and realised industrial yields in the sawing of maritime pine (*Pinus pinaster* Ait.). *Reviewed and accepted for publication in Holz. als Roh- und Werkstoff.*
- V **Pinto I.**, Usenius A., Song T. and Pereira H. Sawing simulation of maritime pine (*Pinus pinaster* Ait.) stems for production of heartwood containing components. Reviewed and accepted for publication in *Forest Product Journal*.

Contributions of the author, Isabel Pinto, in the preparation of the above listed studies:

Studies I–III and V: the author carried out the sampling, measurements, data analysis, writing, and publishing work with input from the co-authors.

Study IV: The author carried out sampling, measurements, sawing simulation, and writing and publishing work with input from co-authors. The second author has done sampling and measurements in the industrial environment.

Papers I–V are reproduced with kind permission from the publishers.

Table of contents

Abstract.....	3
Resumo	4
Preface	7
List of publications	9
1. Introduction.....	11
2. Objectives and overview.....	12
3. Background.....	13
3.1 The wood conversion chain.....	13
3.2 Maritime pine	14
3.2.1 The species.....	14
3.2.2 The wood.....	15
3.2.3 Potential and limitations for industrial uses in solid wood products.....	16
3.3 Measuring and modelling raw-material properties.....	17
3.3.1 How to measure.....	18
3.3.2 What to measure.....	19
3.3.2.1 Stem shape.....	20
3.3.2.2 Knots.....	20
3.3.2.3 Sapwood and heartwood.....	21
3.4 Sawing simulation	23
4. Material and methods.....	25
4.1 Wood raw material – Sampling maritime pine trees	25
4.2 Virtual reconstructed stems	26
4.3 Raw material characteristics.....	26
4.4 Sawing simulation	28
4.5 Validation of stem model and sawing simulation results.....	30
5. Results and discussion	31
5.1 Wood raw material	31
5.2 Data validation.....	32
5.2.1 Stem model	32
5.2.2 Sawing simulation results	32
5.3 Study of raw material characteristics.....	33
5.3.1 Stem and log shape.....	33
5.3.2 Knots	34
5.3.3 Heartwood and sapwood.....	36
5.4 Maritime pine sawing simulation	37
5.4.1 The impact of log shape and internal knots on sawing yield ..	39
5.4.2 The impact of resin tapping on sawing yield	40
5.4.3 Production of heartwood containing components.....	40
6. Conclusions.....	43
7. Further work	45
References.....	46
Appendices	
Publications I–V	

1. Introduction

Wood is a natural renewable resource traditionally found to be a good structural material. Wood processing is ecologically friendly and its products create warm feelings and have high aesthetic values. However, as an engineering material, wood has the disadvantage of non-homogenous properties with a large variability in the tree (both radial and vertical), between trees, and between stands. Also, whereas demand in wood products is forecasted to increase, production forests world-wide are under different pressures and trends are to decrease raw material availability to the wood-processing industry. On the other hand, new solutions should be found to create new products with high added value and satisfying customer needs in relation with other competing materials. The wood industry needs to optimise conversion processes in order to create higher value from fewer raw materials and to promote the link between the customer-specific needs and the forest production. Deeper knowledge of wood properties and how to efficiently process it to respond to market needs are key issues for the optimisation of the whole wood conversion chain.

In this context, the development of machine vision systems and sawing simulation tools increases the knowledge on raw material properties and allows testing different conversion scenarios which support product development and production decisions. Progress in scanning and defect detection technologies and algorithms for virtual reconstruction of logs allow advances in optimisation and sawing simulation procedures. The application of these technologies to the whole wood conversion chain improves the efficiency of raw material utilization and the exchange of information between different levels. Integrated machine vision and sawing simulation systems can be applied in medium-to-long range strategic planning, as well as for operational production control.

Maritime pine (*Pinus pinaster* Ait.) is an important softwood for Southern Europe, covering over 3 million ha. In Portugal, it is the most important species and has a recognised economic importance. This species is the raw material for the sawmill, particleboard, plywood, pulp, and paper industries. The sawmill industry consumes about 70% of the annual wood yield (CESE, 1996). The Portuguese wood-based industry has been facing some problems for the last years, arising particularly from the primary sector, especially the ownership structure and severe forest fires. These imply a decrease in the quality and quantity of the raw material supply to the timber industry and difficulties to compete, in the global wood market, with other species for the mass production of sawn products. A better organisation of the primary sector, optimisation of the raw material conversion, and customised and innovative products are key factors for this species competitiveness in the solid wood products market.

2. Objectives and overview

The multidisciplinary research carried out in this work focuses on the interaction between forestry, harvesting, and industrial wood conversion. The objective was to increase the knowledge on maritime pine wood characteristics and to study the impact of these on the conversion process. The study was performed by applying a technique for the construction of virtual stem models and sawing simulation procedures to maritime pine. The results contribute to the improvement of this species' utilisation as a raw material for the solid wood industry.

In the first part of the work, a characterisation of maritime pine as a raw material for the wood industries was performed based on the 3D virtual reconstructed stems. The objectives in studies I and II were to characterise shape of the stem, internal distribution of knots, and heartwood/sapwood contents. The differences between the studied stem models and reality were also analysed.

The virtual stems were reconstructed based on image analysis of scanned flitches and provided the raw material for sawing simulation studies in the second part of this work (III to V). The reconstruction and sawing simulation were performed by different modules of WoodCIM®, an integrated optimising software system developed at the Technical Research Centre of Finland (VTT). These WoodCIM® modules were reconfigured to maritime pine and its industrial processing conditions. Input process data and products specifications were obtained from the sawing industry.

The potential of WoodCIM® to investigate the impact of the raw material characteristics in the conversion of maritime pine into solid wood products is explored in study III. The aim of study IV was to compare industrially measured sawing yields with the ones estimated by simulation. This supports the analysis of simulated outputs for validation purposes.

Study V explores the potential of maritime pine for the production of heartwood containing components. Specifically, it was aimed at studying how different raw material variables can influence on the sawing yields of heartwood products.

The wood conversion chain is complex involving many affecting parameters not possible to cover completely in one study. Therefore this work presents limitations especially concerning the wood characteristics studied, the sampling and validation procedures. The wood characteristics studied were limited to stem shape, internal knots, and heartwood/sapwood contents. Validation of yields by product quality grade was not possible to carry within this work. The study was based on a sample of 35 maritime pine stems randomly sampled from 4 stands in Portugal. Although the generated batch of logs (total 218 logs) covered a wide range of characteristics, the sample size is still low to cover all the variability of the studied variables.

3. Background

3.1 The wood conversion chain

The utilisation of wood resources starts in the forest, with the supply of raw material, including the bucking of stems into sawnlogs, and proceeds via the manufacturing of sawn timber and its further conversion into products and their end uses (Figure 1). The wood conversion chain consists of forest producers, sawmills, secondary wood processing industries, and finally the consumer of the final product. The different operations proceed sequentially with the final product of one stage being the raw material for the next one.

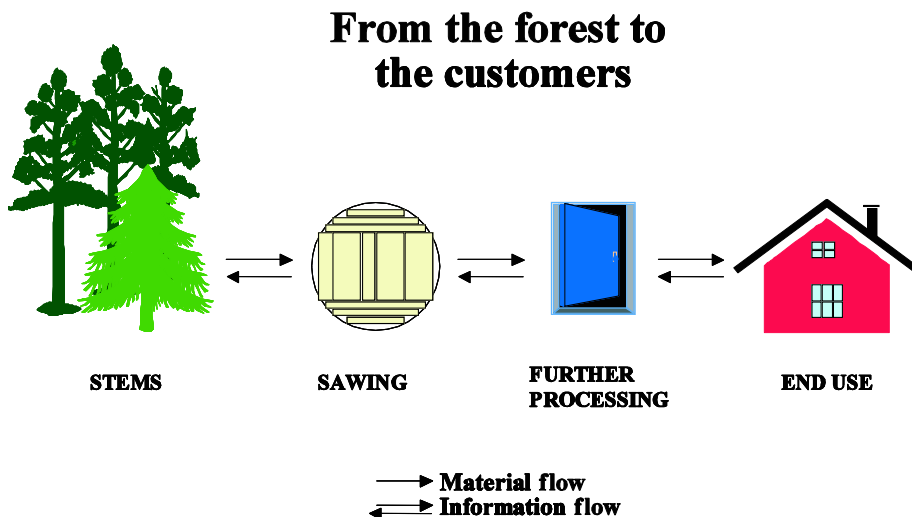

Figure 1. The wood conversion chain (Usenius 1999).

The business environment has changed over the last years from the "Industrial age" to the "Information age". In the "Information age" the market is global and competition is against the best companies in the world. Also the production is customer-oriented rather than volume-oriented and efficiency is achieved by integrating processes and linking business with customers and suppliers (Kaplan and Norton 1996). Traditionally, the wood conversion chain operates with an information gap between its different levels and also has volume-oriented manufacture processes. Moreover, the high variability of the wood properties may create incompatibilities between the initial raw material and the final product, leading to waste, and economical losses. To maintain competitiveness in the "Information age", the wood conversion chain needs to be optimized as a whole. Wood raw material must be chosen taking into account the requirements set for the final products. Therefore, the optimisation of the wood conversion

chain requires a flow of information in the reverse course of the raw material flow. In this way, the end-users will press the industry to supply products with certain requirements and these, in turn, can press the raw material producers. The business in the wood industry is increasingly dynamic, flexible, and customer-oriented which requires effective planning of the production along with more flexible and faster decisions.

Modelling, image analysis, traceability, simulation, and machine vision systems are useful tools for the integration and optimisation of the wood conversion chain as a whole. These allow the production, identification, and selection of the correct raw material for a certain end product. Simulation tools can be used to test different scenarios in a virtual world thereby supporting production research and creating information for management, decision-making, and process control. This requires a constant collaboration between the industry and the research centres.

3.2 Maritime pine

3.2.1 The species

Maritime pine (*Pinus pinaster* Ait.) is an important softwood for Southern Europe. Its origin is still not very clear but it has naturally spread in the Mediterranean regions of France, Corsica, Spain, Italy, Sardinia, and Sicily (subspecies *pinaster*) and in the Atlantic regions of Portugal, Spain, and France (subspecies *atlantica*). In the last decades, this species was introduced with success into South Africa, New Zealand, and Australia. In Portugal, it is the most important with an occupation area above 1 million ha (30% of the total Portuguese forest area). (Figure 2)

Pinus pinaster Ait. is an evergreen species with an adult tree height of 25 m to 40 m. The crown is usually pyramidal at young ages and round in adult trees. Well adapted to very temperate maritime climates, this species has characteristics of a pioneer species. It registers higher growth rates in low/medium altitudes (between sea level and 1100 m) in sites with 11–15 °C as an average annual temperature and with high humidity and precipitation. In Portugal, the average annual production of maritime pine is 5.6 m³/ha/year. In relation to edaphic conditions, it is a very tolerant species with preferences for light and sandy soils, and growing very well on acidic and poor soils (Alves 1982). The main natural enemies of Maritime pine are fire, some fungi, wood beetles, and its high sensitivity to the attack of processionary caterpillars. Maritime pine is managed as high-forest silvicultural systems with clear cutting followed, commonly, by natural regeneration.

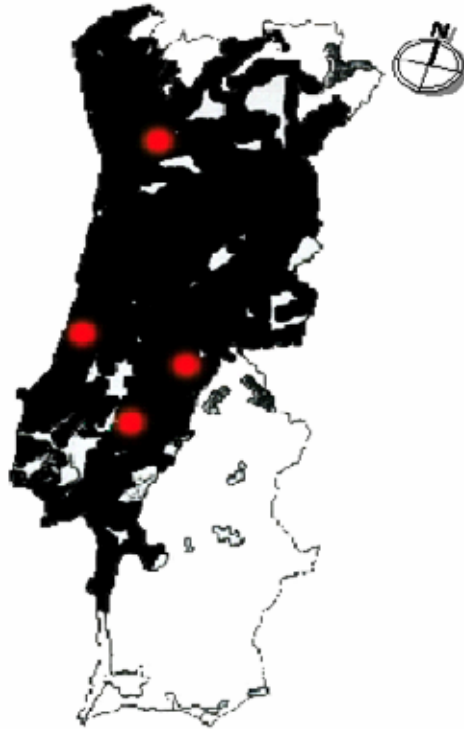

Figure 2. Distribution of maritime pine in Portugal (dotted marks shown the localisations of the stands sampled for this study).

3.2.2 The wood

Maritime pine wood is pale yellow in the sapwood and reddish-brown in the heartwood. The heartwood is distinct and in the transverse section the growth rings are distinct and clearly visible. Some trees have straight-grained wood while others present spiral grain. The wood is resinous with a rather coarse and uneven texture, and a stripe figure (tangential section) due to the growth rings. The annual rings may present a widely variable thickness but are usually wider in the centre near the pith and thinner at the periphery. The width of the latewood tends to be constant (Carvalho 1997, Cruz et al. 1998). Growth rings show a clear contrast between earlywood and latewood, mainly due to the dark thick-walled latewood cells. The pith is more or less circular with a considerable volume. Maritime pine wood is classified as light or moderately heavy and moderately strong in a mechanical point of view (LNEC 1997). The main physical and mechanical properties are summarised in Table 1.

Table 1. Average physical and mechanical properties of maritime pine wood.

Physical properties	
Density: (H=12%) (gr/cm ³)	0.53–0.60
Total volumetric shrinkage (%)	14
Total tangential shrinkage (%)	8.5
Total radial shrinkage (%)	5.0
Volumetric shrinkage coefficient (%)	0.6
Fiber saturation point (%)	30
Mechanical properties	
Compression parallel to grain: strength (N/mm ²)	53
Shearing strength (N/mm ²)	10
Static bending: bending strength (N/mm ²)	96
Cleavage: Rupture force (N/mm ²)	4
Tension parallel to grain: tensile strength (N/mm ²)	87
Tension perpendicular to grain: tensile strength (N/mm ²)	3

Source: LNEC 1997 (small clear specimens, 12% moisture content)

3.2.3 Potential and limitations for industrial uses in solid wood products

Maritime pine wood is used as raw material for the sawmill, plywood, particle board, fiber board, pulp, and paper industries. In Portugal, the wood based sector represents 8.6% of the total industrial Gross Value, 3.8% is coming from the pulp and paper industry and 4.8% from the other wood-based industries. Sawmills consume around 70% of the produced maritime pine timber. This species represent 88% of the volume of raw material consumed in these industries (CESE 1996).

Considering its strength, workability and easy treatment with preservatives, maritime pine wood has the potential to be used in several products, both indoors and outdoors. It is currently used in structural elements for roofs and floors, stair frames, prefabricated timber buildings or components, joinery and furniture. It has also been used in foundations, transmission poles, railway sleepers, scaffolding, fences, and other elements to be applied in open air or in ground contact. Although products for building construction have been the traditional end products of the sawmill industry, in the last 30 years pallets have become the main production item in volume.

The timber has good workability if it is well seasoned and without many defects. It is readily easy to work with machinery and hand tools, and allows a good finishing. It holds mechanical fasteners well, glues easily, and can be given a good finish. Drying can be carried out rather easily, either by air-drying or by kiln drying. This species is sensitive to sap staining and mould growth, thereby it must be dried rapidly, though avoiding seasoning checks and distortion (LNEC 1997, Cruz et al. 1998).

When compared with other pine timbers, like Scots pine, maritime pine wood is normally more resinous and when produced under conditions favourable to rapid growth is generally coarser, knottier and with a large proportion of sapwood (DSIR 1960). For structural uses, knots, pith, and associated juvenile wood are amongst the worst defects. Being a fast-growth species, maritime pine is very sensitive to climatic changes which are very common in the moderate seasons of Southern Europe. This increases wood heterogeneity especially concerning growth ring widths and anatomic element dimensions. Also, the stands of this species are frequently close to the sea, thereby exposed to frequent winds which increase the quantity of resin pockets, stem eccentricity, and reaction wood.

Therefore, it is very important to make a careful selection of this timber, in accordance with the intended uses. In Portugal, the structural timber of maritime pine is classified with visual grading rules into two main grades: grade E (structures) is suitable for general purposes, and grade EE (special structures) is the higher strength grade. This classification is based on the Portuguese standard NP 4305 (1994) and it is compatible with the Eurocode 5 (ENV1995-1-1).

Maritime pine is a very resinous conifer and has been commonly used for resin production. Resin tapping is done by wounding the lower part of the stem and stimulating the exudation of resin with acid. The butt log of resin-tapped pines shows therefore scars on the external part of the stem and considerable quantities of resin remain in the wood. This industry is now in a deep crisis due to the lack of competitiveness in international markets, mainly in relation to imports from China and to the high labour costs. Therefore, most stands have abandoned resin tapping. However, many of the pine trees available have been tapped and are a concern for the sawmill industry because the valuable butt logs are depreciated.

3.3 Measuring and modelling raw-material properties

The knowledge of the wood raw material properties in prior to conversion allows selecting it for certain uses and processing it according to customer's specifications. Looking upstream, the variability of these wood properties can be connected with tree and stand growing conditions such as genetics, silvicultural history and site environment. On the other hand, a good model for the wood raw material is required for a virtual sawing capable of predicting quality distribution of the sawn products. Therefore, the measurement and modelling of wood properties can support foresters and industry in producing and processing the right raw materials for a specific end use. Application of machine vision systems and modelling tools to the wood conversion chain, makes it possible to create virtual representations of stands, trees, and logs. These 3D models and representations of trees and logs give information about their geometry and internal properties which created the concept of "the glass log".

3.3.1 How to measure

The tree and logs model and representations can be divided into two main groups according to the techniques used and the origin of the raw material information:

- Growth models (models with a physiological base),
- Empirical models based on direct measures (on the board, log, or stem).

The growth models create tree and stand representations based on ecophysiological processes using inventory data and individual tree measurements. Traditionally, these models concentrate on forest production and management. In the second stage, these advance to link the management of forest resources and the simulation of tree growth with the wood properties (Kellomäki et al. 1999, Mäkelä and Mäkinen 2003) and further with the simulation of the raw material conversion and end products (Houllier et al. 1995, Blaise et al. 2002, Verkasalo et al. 2002, Ikonen et al. 2003).

The direct measurements of logs and stems can support research on the raw material properties and on the development of new systems for direct application to industrial environments concerning saw-milling optimisation and simulation procedures. The mathematical reconstruction of logs and trees based on scanning technology can now provide accurate 3D representations and detailed information regarding geometry of stems and internal properties. These measurements can be destructive, if the analysis is made on log parts, or non-destructive if it is made on whole log or stem. The destructive approach is, obviously, only applied in the research, development, and validation phases as industrial application requires non-destructive techniques. There are several techniques that can be applied to collect data on stems and logs. The most commonly used in scientific research and/or industrial applications are based on scanning the log surface and its internal properties by ultrasound, x-ray, gamma ray, infrared, nuclear magnetic resonance (NMR) or optical systems.

Virtual representations of logs and stems can be created based on the analysis of images resulting from the optical scan of boards (Song 1998, Funk et al. 2002). On these, the geometric and quality features are identified allowing virtual reconstruction of the original stem/log raw material. The analysis of high-resolution wood images (e.g. obtained with RGB colour-based scan systems) allows the accurate identification of different wood properties. Although destructive, these methodologies can generate a virtual raw material database with detailed information on wood properties. This allows the study on wood properties and the testing of different conversion scenarios. Also, it supports the development of industrial applications of sawing simulation programs.

In the past few years, x-ray based applications have been researched and developed for the wood industry in order to detect inner characteristics of the logs and stems (Grundberg 1999, Oja et al. 2001). This technique registers the quantity of x-ray radiation that goes through the material being measured which

is a function of its thickness, density, and humidity. The study of a 3D object requires multiple measurements in different directions. In a log/stem case this means measurements at different angles around its longitudinal axis. The increase in measurement angles leads to higher accuracy for the detection of internal defects but also implies an increase in the signal processing and consequently in the scanning time. Therefore, industrial applications of x-ray based technologies try to find a balance between the defect detection accuracy, the needs for on-line speed, and the costs.

In order to increase the detection accuracy of the inner properties, an x-ray based biomedical technique, the computer tomography (CT), has been applied to wood science (Wagner et al. 1989, Hagman and Grundberg 1995, Schmoltdt et al. 1996, Oja 1997, Bhandarkar et al. 1999). The CT scanning of logs and stems is based on measurements taken at a high number of angles. In this case, the x-ray source and detector (with a curved shape) rotates around the log or stem. As mentioned above, the limitation to the industrial application of this technique is the scanning time and the costs.

Another biomedical technique being investigated for wood applications is Nuclear Magnetic Resonance (NMR), as it allows detection of wood properties with high accuracy (Chang et al. 1989, Morales et al. 2002). This technique is based on the nuclear properties of the material and, as a generalisation, one can say that the output signal is proportional to the concentration of hydrogen atoms. Therefore, in NMR images the intensity value of a pixel will be a function of the moisture and chemical elements of wood (lignin and cellulose, for example). This technique is only used in research studies as the signal acquisition is too slow for industrial applications, and it requires very specific installation conditions and high costs.

3.3.2 What to measure

Wood formation is a process with many different variables including genetic inheritance, tree age, climatic variations, soil conditions, and silvicultural practices. All these factors interact with each other and act at different levels with various intensities implying large variation in growth conditions and, as a consequence, variation in wood properties. The variability is present within the tree, between different trees, and between different stands (Zobel and Buijtenen 1989).

The selection of which properties to detect or measure for the development of virtual representations of the wood raw material depends on their impact in the quality requirements of the end products. Thus the wood quality must be defined in terms of end uses and this definition should be harmonised throughout the different parts of the wood conversion chain. Quality should be defined based on all the wood characteristics and properties that affect the value yield in the chain and the serviceability of end products (Zhang 1997). The quality definition concerns wood properties, defects, and the presence of desirable and undesirable characteristics.

Each product has a particular set of quality requirements and these are connected to variables of wood resource. Quality of solid wood products normally involves evaluation of the characteristics at the stem and log level (form and volume, reaction wood and eccentricity, size and type of knot, growth ring width, heartwood and sapwood) and wood properties (grain, wood density, anatomical and chemical characteristics, mechanical properties, durability and permeability, aesthetic aspects). The choice of the variables described below was based on the perspective used in this thesis.

3.3.2.1 Stem shape

Tree form and stem volume are directly connected with log value, harvesting and processing costs, and sawing value yields. During conversion, log diameter, taper, and sweep significantly impact the lumber yield and grade. These are among the main characteristics for log grading before conversion. Large taper might reduce sawing yield in order to avoid wane in the final products. Furthermore, mechanical properties will be reduced due to the impact of the taper in the grain. Log diameter also affects the size of the lumber to be produced. The same volume of logs from different diameter classes could result in different product outputs. Smaller logs are generally associated with higher conversion costs, reduced yield, poor dimension stability, and increase number of defects (Zhang 1997).

3.3.2.2 Knots

Knots are portions of the branches enclosed within the wood of the stem. If the branches are alive at the time of the inclusion, knots are called green or sound as their tissues are continuous with the stem ones. When the branch dies the continuity of the tissues breaks and originates an attached dead or dry knot. These might be attacked by decay and be classified as rotten knots (Desch and Dinwoodie 1996). The quantity, size, and quality of the knots in a tree stem are a function of the species and genetics, growing environment, and forest management.

Characteristics of internal knots such as knot quality, length, and diameter distributions within the stem, strongly contribute to the value yield from log sawing. Knots are denser than the stem wood and imply grain deviation not only in the knot zone but also in adjacent wood. Dead knots affect more the mechanical properties and aesthetic aspects than sound knots. It is important to estimate the size, type, and also the position of the knot in the sawn wood. Normally an edge knot affects strength more significantly than a knot located at the centre of the flat face. Knots are the main cause for sawn timber downgrading particularly due to their effects on warping, mechanical properties and aesthetics. For maritime pine, Machado (2000) reports that knots count for 50% of the rejections in the grading for structural uses and for 44% of downgrading in visual strength grades.

Studies on knottiness have been carried out by several authors for Scots pine (*Pinus sylvestris* L.), Norway spruce (*Picea abies* (L.) Karst.), and silver birch (*Betula pendula* Roth.) using different techniques: direct measurements of the knot parameters (Pietilä 1989, Vestøl et al. 1999, Heräjärvi 2002, Vestøl and Høibø 2000), peeling methods to produce veneer strips, further measured with an electronic device (Lemieux et al. 1997), CT-scanning technologies (Björklund 1997, Björklund and Petersson 1999, Moberg 1999, Oja 1997), and inventory data and predicting models (Colin and Houllier 1991, 1992; Houllier et al. 1995, Mäkinen and Colin 1998, 1999, Mäkinen et al. 2002). For maritime pine, knottiness has been studied through crown architecture and external branch measurements (INRA 1994, 2000, Paulo and Tavares 1996, Tavares and Campos 2000). This species' crown is well branched, especially at young ages and natural pruning is weak. However, several branches dry and allow the remaining ones to increase in diameter.

3.3.2.3 Sapwood and heartwood

In the xylem of most tree species, with natural ageing, the parenchyma cells die and lose their reserve material, wood is impregnated with complex organic compounds (normally referred to as extractives), and water conductance is hindered by the aspiration of pits. This process forms two histologically similar but physiologically different zones: the outer sapwood and the inner heartwood.

The sapwood contains living parenchyma cells and reserve materials and has conducting, storage, and supporting functions. The outer rings transport water and minerals from the roots to the cambium and leaves. The heartwood is physiologically inactive concerning water conduction. The organic compounds impregnated are responsible for the natural durability of this xylem zone and for its usually darker colour. The mechanisms underlying the formation of heartwood and its functions are not yet well known. It has been suggested that heartwood formation serves to regulate the amount of sapwood to a physiologically optimum level (Bamber 1976) following the “pipe-model” theory relating sapwood area to foliage mass (Shinozaki et al. 1964). The amounts of heartwood and sapwood should therefore be related to all factors and conditions that affect crown size and vitality (Mörling and Valinger 1999, Bergström 2000). Other studies support that, after a certain initiation phase, heartwood is formed at a constant annual ring rate. Consequently, heartwood would be related with cambial age and with the factors that impact growth rates, mainly in the early stages (Hazenberg and Yang 1991; Wilkes 1991; Climent et al. 1993, 2002; Sellin 1994; Björklund 1999; Gjerdrum 2002).

Heartwood and sapwood contents vary between and within species and have been related to growth rates, stand and individual tree biometric features, site conditions, and genetic control. Reviews on heartwood and sapwood formation and variation have been reported by Bamber and Fukazawa (1985), Hillis (1987), and Taylor et al. (2002).

During the heartwood formation the process of the pit aspiration decreases the moisture content and forms a natural physical barrier to the penetration of insects and fungi. At the same time, the death of the parenchyma cells implies the loss of sugars in this xylem zone. This decreases the conditions for organisms to develop. Also the accumulated extractives are toxic to these organisms. All these factors make the heartwood to be naturally more durable than the sapwood. On the other hand, the infiltration of the extractives in the cell wall reduces heartwood's shrinkage and swelling capacities, thus increasing its dimensional stability. Therefore, heartwood and sapwood have different moisture content, chemical composition, colour, density, mechanical, and technical properties such as suitability for chemical treatments.

In maritime pine, the heartwood is naturally resistant and the sapwood is very easily impregnated by preservation products. The sapwood is susceptible concerning wood-destroying fungi, termites, and wood-boring beetles like *Anobium* and *Hylotrupes*. The heartwood is slightly to moderately durable to the fungi, moderately durable to termites, and durable to wood-boring beetles (Cruz et al. 1998). In this species, the dry heartwood shows a strong reddish colour. Studies concerning heartwood and sapwood development in this species have shown that this xylem zone represents 20% of the cross-sectional area and 44% of the diameter at breast height and contains 3 times more extractives than sapwood (Esteves 2000). Stokes and Berthier (2000) and Berthier et al. (2001) studied the heartwood irregularity in relation with reaction wood in leaning trees and found more heartwood rings on the leaning side of the tree, while Ezquerro and Gil (2001) reported on heartwood anatomy and stress distribution in the stem.

The content of sapwood and heartwood within the tree, its proportion and variations, have therefore a significant impact on the utilisation of the wood. For pulping, heartwood may be a disadvantage as its extractives can affect the process and product properties. For solid wood applications, the different properties of these two stem zones influence issues such as drying, aesthetic values for the consumer (ex. panels and furniture), gluing ability, painting, durability and ecological concerns. For sawmill, joinery, and furniture industries heartwood-targeted products provide good opportunities to increase competitiveness of wood products in relation to other substitute materials. The increasing concern about the preservative treatments makes the natural-durable heartwood products an environmentally friendly alternative for the consumer. Moreover, heartwood products, when carefully selected, have better dimensional stability and the application of reconstructive techniques, such as finger joint, helps to reduce the defects and material heterogeneity.

3.4 Sawing simulation

Within the context of the wood conversion chain optimisation, sawing simulation tools have been developed in order to link wood raw material, production processes, and products together for supporting production planning procedures in mills. Models and simulation tools allow studying how a set of logs and its properties, specific conversion variables, options, and scenarios are impacting on the sawing yields. Sawing simulation software always requires extensive input data concerning products, sawing processes, and wood raw materials.

The first studies used input raw material data derived from the measurements of actual logs (McAdoo 1969, Tsolakides 1969, Cummins and Culbertson 1972, Richards 1973, Usenius 1980, Grönlund 1989). Logs were described as straight truncated cones with circular cross sections. Others have displayed the raw material with computer graphics as in the studies of Pnevmticos et al. (1974), Occena and Tanchoco (1988) and Todoroki (1990). Pnevmticos used truncated cones and cylinders to approximate log shapes and rectangular boxes to approximate defects. Defect location and dimensions were randomly generated. In Todoroki's first studies, logs were represented as a series of polygon cross sections and defects as cross-sectional whorls. In 1988, Todoroki modified the log profile to allow the representation of eccentric logs by elliptical cross-sections and in 1990 it was further developed as the AUTOSAW simulation system (Todoroki, 1996).

In other cases, a growth modelling approach has been used and tree models representing external and internal stem features are the input data (Leban and Duchanois 1990, Lönner and Björlund 1999, Ikonen et al. 2003). Leban and others (1990, 1996) developed the programs Win-EPIFN for geometric reconstruction of stems and SIMQUA for prediction of the wood properties in the boards. The SIMQUA software is focused on modelling of wood quality and linking it with different growth models. The model can be used to evaluate the quality and values of the boards from one existing forest resource at one regional level. The tree wood properties and the sawing pattern are given as inputs and the sawing of boards with the respective properties is simulated.

With the development of scanning technologies, several research teams have created scanner-based simulation tools. These use data based on scanning of logs or boards and reconstruction algorithms producing a 3D description of a log or stem concerning its internal defects and shape. Raw material data were derived from computed tomography (Occena and Schmoldt 1996, Schmoldt et al. 1996, Chiorescu and Grönlund 2000, Thawornwong et al. 2003) or scanning of boards (Åstrand and Rönnqvist 1994, Usenius and Song 1996, Usenius 1999, 2000). Åstrand and Rönnqvist (1994) developed a simulation model for optimisation of crosscutting operations in the secondary wood industry. The model is based on information from scanned boards and matches the quality requirements of the end products to the quality of the raw material. Another system, the virtual

SawMill (vSM) sawing simulation software, uses as input raw material the digital logs from the Swedish Stem Bank, a database of 200 virtual Scots pine stems reconstructed based on CT scanning images (Grundberg 1999). This simulator allows testing different sawing alternatives and outputs physical data of the products, as well as economic results. The program also permits to use direct sawmill input from the 3D profile log scanners.

Over the years, wood sawing simulation systems have been designed and improved in order to reach an accurate virtual wood conversion chain linking raw material properties to industrial production. With the development of possibilities for defect detection and information systems, it is increasingly possible to add new raw material properties to the models and to integrate more operations within the wood conversion chain.

Since the early 1970s an integrated optimising software system, the WoodCIM® (Usenius 1980, 1999, 2000) has been under development, at VTT, the Technical Research Centre of Finland. This consists of several software modules that support research and can be linked to the product and material flow control system or other computer systems at the sawmill:

- software for optimising selection of stands and bucking of stems
- program for optimising the limits of sawlog classes
- simulation program for predicting the value yield in sawmilling
- software for optimising manufacturing of components
- sawing model based on linear programming.

The WoodCIM® software system has been developed for the wood conversion chain of Scots pine (*Pinus sylvestris* L.) and spruce (*Picea abies* (L.) Karst.). For the work described in this thesis, the stem reconstruction, bucking, and sawing simulation modules of WoodCIM® were adapted to the conversion of maritime pine.

4. Material and methods

For the studies presented in this thesis, mathematical reconstruction algorithms were used to produce 3D virtual models of logs and stems of maritime pine (*Pinus pinaster* Ait.) (Figure 3). These provided the data for studying raw material characteristics as log external shape, internal knots, and heartwood/sapwood contents (Studies I and II). A sawing simulation tool used this virtual raw material as input to provide data for studies III to V, concerning maritime pine production yields. These techniques are described briefly below and in more detailed in the respective papers.

4.1 Wood raw material – Sampling maritime pine trees

Thirty five maritime pine trees were sampled from 4 stands in Portugal, covering the species' area of distribution and different management types: 20 trees in Leiria (S1), 5 trees in Mação (S2), 5 trees in Alpiarça (S3), and 5 trees in Marco de Canavezes (S4). Due to low quantities of heartwood, trees from S2 were excluded from study IV. For that study, the sampled sites were referred to as LE, AL and MC, respectively for S1, S3 and S4. However, in this thesis the sample sites are always referred to as S1, S3 and S4.

The trees were randomly sampled within each site. Diameter at breast height (DBH), total height, crown height and height of the first visible dry branch were measured for each tree. Two cross diameters (N-S, W-E) were measured every 2.5 m along the tree and the bark thickness was determined with a bark gauge in the location of the greatest thickness. Table 2 gives the biometric data for the sampled trees. The trees were bucked into 5 and 2.5 m logs, where the North-South orientation was marked. Wood discs (5 cm thick) were taken for growth ring analysis at the bottom end of each log and at the top end of the top log.

Table 2. Biometric characteristics of the sampled maritime pine trees (mean with standard deviation in parentheses) and site index.

Stand	S1		S2		S3		S4	
Site Index ⁽¹⁾	DH (40)> 17 m		DH (40)> 14 m		DH (40)> 18 m		DH (40)> 21 m	
Age	83 years		43–55 years		42–55 years		48–55 years	
Number of sampled trees	20		5		5		5	
Total height (m)	28.8	(2.8)	15.7	(3.4)	21.3	(1.0)	24.1	(1.0)
Crown height ⁽²⁾ (m)	8.7	(2.6)	7.7	(3.5)	9.1	(1.9)	10.0	(2.0)
Dead Crown base (m) ⁽³⁾	16.0	(2.1)	7.7	(1.2)	7.8	(1.3)	8.0	(1.6)
DBH (cm)	47.8	(7.3)	28.0	(2.3)	38.9	(9.2)	42.7	(5.3)
Volume over bark (m ³) ⁽⁴⁾	2.7	(0.7)	0.5	(0.1)	1.3	(0.6)	1.6	(0.1)
Volume under bark (m ³)	2.3	(0.6)	0.4	(0.0)	0.9	(0.4)	1.2	(0.2)

(1) Dominant height (DH) at 40 years (Tomé et al. 1998) (2) Crown height = total height – live crown base height; crown base at the simultaneous occurrence of 2 green branches (3) Height from tree base to the first visible dry branch (4) Precise cubic method, Smalian formula.

4.2 Virtual reconstructed stems

The 35 sampled trees were transformed into a set of virtual stems by mathematical reconstruction based on the so-called flitch method. A total of 133 logs were live sawn into 25-mm thick flitches. The flitches were scanned using the WoodCIM® camera system providing RGB (colour component) information and the scanned images were processed using the PuuPilot image analysis software. On the image of the flitch and with assistance from the operator, the system registered the xy-coordinates of the geometrical outline of the sawing surface and heartwood, the log pith line and the location, and size, shape, and quality factor of each knot. The mathematical reconstruction of the log in the xyz-coordinate system is then based on the geometrical and quality features of the flitch, its thickness, and with the support of the North-South reference line to create the 3rd coordinate. Finally, the whole stem is reconstructed by addition of the different logs from one tree. Cross-sections of the log/stem were described with a set of 24 radial vectors between pith and outline points of the surface of the log along the length of the log in 50 mm intervals (Song 1987, 1998; Usenius 1999).

In the scanned images of all flitches, the heartwood part was identified out from the sapwood by colour difference. The data concerning the geometric features of the heartwood, were processed with the same algorithms and methodology described above for the log/stem geometry. Therefore, a 3D representation of the heartwood along the log was obtained and integrated with the reconstructed logs' data (shape and knot internal structure) based on the common pith xy points. The heartwood in the stem was subsequently reconstructed by joining the different logs of the tree. Details of the log/stem reconstruction can be found in studies I and II. Figure 3 shows the output of a mathematical reconstruction of one maritime pine log.

4.3 Raw material characteristics

The parameters for the studies on the stem geometry and knots (studies I and II) and heartwood and sapwood (paper II) were calculated based on the virtual stems.

- Log shape and internal knots (I)

Log shape was described by diameters for each 50 mm of log length, and by taper and pith curviness. Pith curviness was defined as the maximum deviation (in any direction) of pith, found along the log, in relation to an imaginary axis defined by a straight line connecting the pith points at butt and top end of the log (mm/m). Each individual knot was described by its diameter, length, and volume (total and sound), the knot pith position in the tree height (Z-coordinate), and the compass angle in the stem/log cross-section (Figure 4). These outputs were used to study the variation of knot length, diameter, and volume with tree height level: for each dimension it was calculated the average of all knots within sections of 5% of tree height.

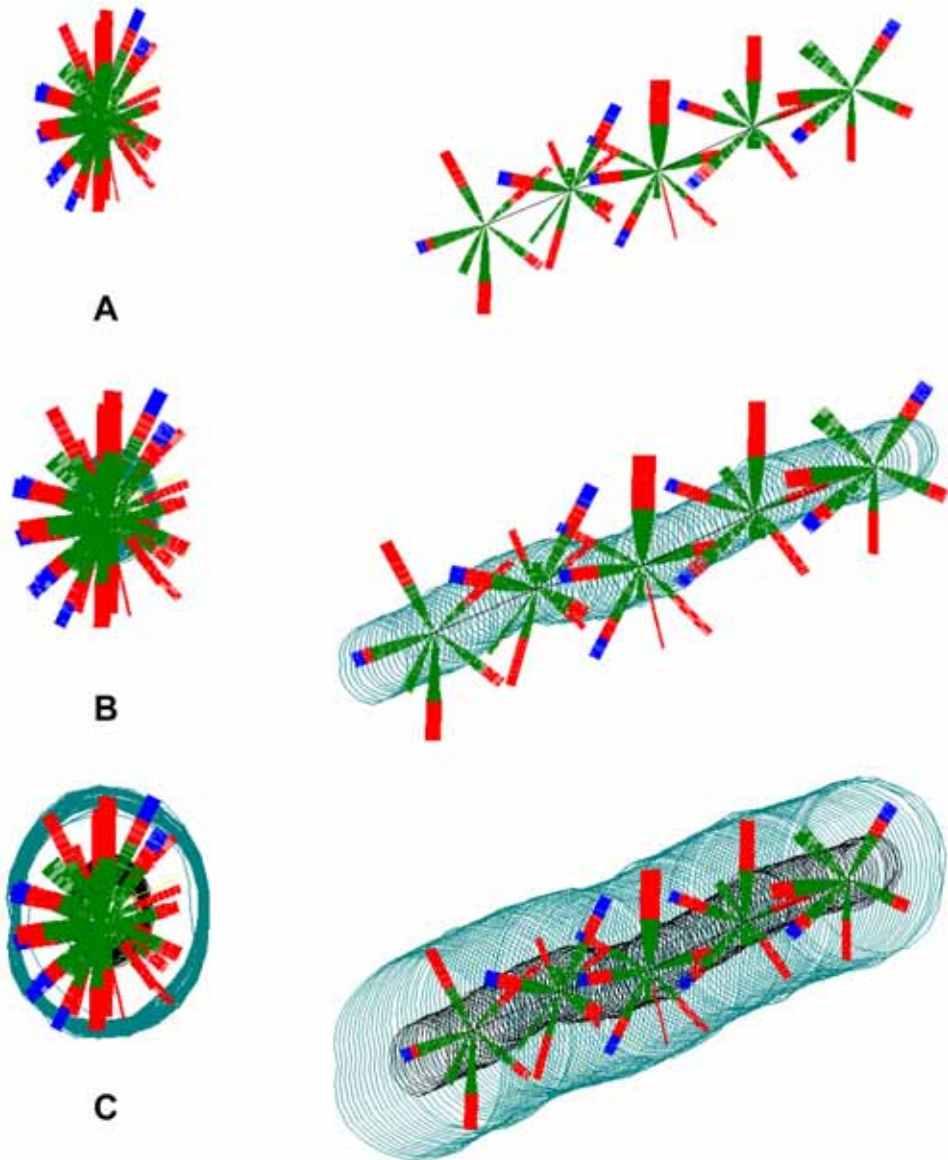

Figure 3. Mathematical reconstruction of one maritime pine log showing in two and three dimensions: the internal knot architecture (A), the heartwood and the internal knot architecture (B), and the full model with the geometry of the log (C). Knot colour code: green – sound, red – dry, blue – rotten.

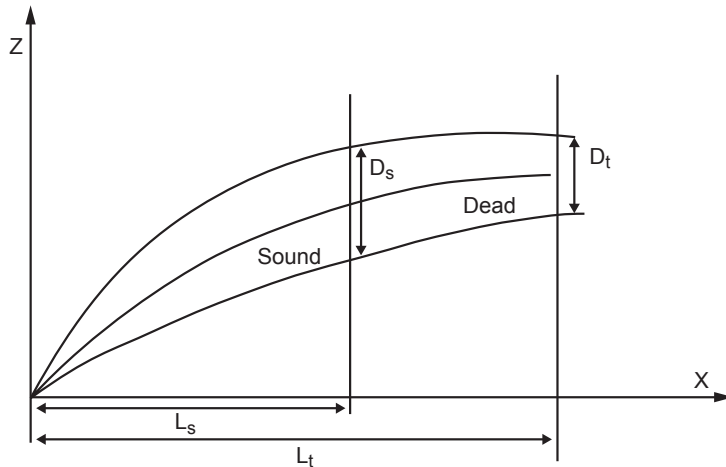

Figure 4. Projection of a knot to the xz plane, total (D_t) and sound (D_s) knot diameter, and total (L_t) and sound (L_s) knot length. Axes z and x correspond, respectively, to the axial and radial direction (Adapted from Song 1998).

- Heartwood and sapwood (II)

The amount of sapwood and heartwood was computed for each 50 mm section of stem height by using the following variables: average stem, heartwood and sapwood diameter, area and volume, and respective proportions in the stem. The sapwood area and volume were calculated as the difference between the corresponding values for stem and heartwood. Growth rings within heartwood and sapwood were counted and measured on wood discs. These were used to study the heartwood development with tree age and also to compare reconstructed heartwood and sapwood dimensions with real values.

4.4 Sawing simulation

The bucking and sawing simulation software modules of WoodCIM® were used in studies III to V. The software used is flexible allowing modifications for the adaptation to a new species and processing conditions. The free specification of product dimensions and qualities, concerning size and number of knots is also possible. The software was reconfigured for maritime pine.

The bucking module allows cutting the virtual stems into any desirable log length and with different lengths in the same stem. In the Portuguese wood industry, 90% of the sawn logs have 2.6 m length. Therefore, this was the log length used in studies III and IV. In study V stems were cut into different log lengths: 2, 3, 4, and 5 m.

The program calculated the sawing yield by using different sawing set-ups for each log and by choosing the best combination of sawing patterns, dimensions, and qualities of the sawn timber products. The nominal and green dimensions of sawn timber products, the quality requirements for each face, prices of sawn timber products and of by-products, and saw kerfs were also introduced as input variables. The output results were the best set-up and sawing pattern, the number of sawn timber products by dimension and grade, and the volume and value yield of sawn timber products. The results were obtained for the entire batch of logs, for the logs of one stem, for the individual logs, and for a specified log group (i.e. butt, middle, and top logs).

The potentialities of this software for the application to the industrial conversion of maritime pine were explored in study III. Using the reconstructed maritime pine stems as input, the influence of raw material and process variables on the simulated sawing yields was studied. The sawing module could be applied using as input both the original virtual stem as well as the heartwood part extracted from the stem because heartwood was reconstructed using the same algorithms as for the stem shape (II). Therefore, heartwood can be virtually sawn separately from the stem allowing the calculation of sawing yield for the heartwood products (V). By adapting different wane specifications, it was possible to saw components with at least one heartwood face, the remaining volume being within the sapwood (Figure 5). The heartwood containing products are referred to as heartwood products. Sawing set-ups and input process data were obtained from the Portuguese sawmill industry and were defined, for each case, in studies III to V.

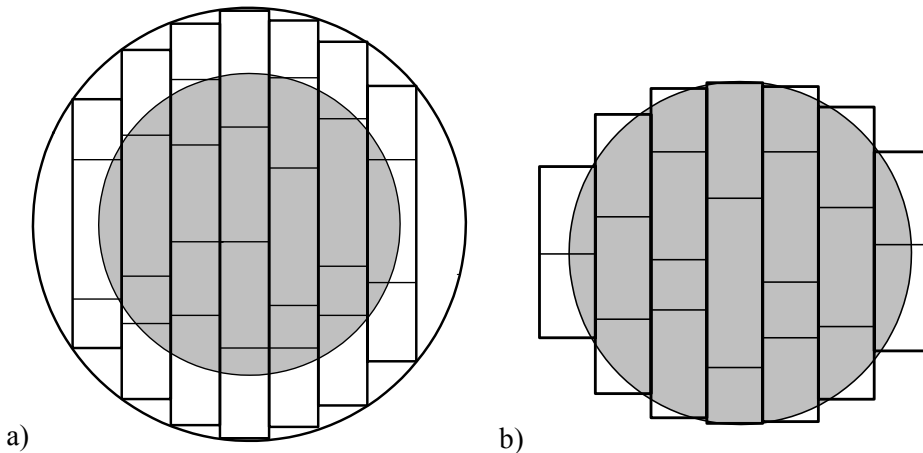

Figure 5. A schematic representation of the sawing simulation of whole log (a) and heartwood part (b).

4.5 Validation of stem model and sawing simulation results

The scanned images of all the flitches of the 4 logs from one tree containing a total of 245 knots were manually analysed to determine the number of knots and their original position in relation to tree height. These values were compared with the reconstruction output (I). Also in study I, the reconstructed stem diameters were analysed in relation to collected field data. Diameters measured in the harvested trees were compared with the reconstructed ones at the same height level. The heartwood and sapwood reconstruction was validate by comparing it with growth ring measurements obtained from the wood discs (II). The sawing simulation output concerning estimated volume yields was studied in relation to industrial measured yields (V).

5. Results and discussion

The virtual 3D maritime pine stems allowed a clear visualisation of important quality features and their subsequent study and quantification, e.g. log geometry, knot parameters and heartwood. These have been explored in studies I and II. The reconstruction of heartwood shape in study II was a new feature added to the reconstruction module.

Study III reports the potentialities of the WoodCIM® sawing simulation software for application to the industrial conversion of maritime pine. The main adaptations developed for this species were explained and the sawing simulation results analysed in relation to raw material properties and process variables. The sawing simulation module was further utilised to study the production of heartwood containing products from maritime pine in study V. In order to evaluate the errors resulting from generated results in a virtual environment, studies I–IV compared the reconstructed stem features and sawing simulation outputs with real values.

5.1 Wood raw material

The maritime pine trees studied were sampled from four sites (S1–S4) with variable natural conditions and also with different silvicultural history. These differences were reflected in the results, with the biggest gap being between S1 and the other remaining sites. The Leiria site (S1) is a state-owned forest where management is oriented to produce wood raw material for high added-value timber products. The silviculture consists of 5-year rotation thinnings between 20 and 40 years of tree age, pruning before the first thinning (up to 2 m height), and clear cutting at an approximate age of 80 years (Gomes, 1999). In the private-owned Portuguese pine stands (S2, S3, and S4) rotation is about 40–50 years. In most of the cases there are no cultural operations and no cleaning of undergrowth vegetation.

Trees harvested from S1 are probably a part of the best quality fraction available in Portugal for the saw-milling industry. Also, the number of sampled trees was higher in S1. Therefore, some data was analysed considering two groups: S1 trees and S2, S3, and S4 trees (II, III, and V). Results concerning trees from S2 to S4 were also analysed considering some other aspects as S2 was a mountain site and some of the S3 trees were severely resin tapped.

5.2 Data validation

5.2.1 Stem model

The stem and heartwood diameters obtained from the reconstructed model followed very closely the actual diameters (I and II). For the stem reconstruction, the difference between modelled and field measured diameters was below 1% of the measured values except for the 20 m level where the modelled diameter was 4% higher than the measured diameter. These higher differences found for top logs resulted from the more irregular shape of stem at this level, already located in the dead crown area and with larger knots. The accuracy of the model regarding heartwood diameter was in the same range, though the variability of the differences was higher. On average, the modelled diameters were 4% below the measured ones, ranging from -12.9% to +8.4% at the different height levels. The correlation between modelled and measured diameters was highly significant ($P < 0.001$, $R^2 = 0.88$) and showed very few outliers.

Differences between the actual stem and heartwood diameters with the reconstructed ones may have arisen from the different number of diameter measurements taken for the average. The reconstruction model gives 12 heartwood and stem diameters for each cross-section. The actual values were the average of two diameters for the stem (measured in the field) and 4 for heartwood (on the wood discs). Also, the measurements were based on a 25-mm flitch thickness and the reconstruction of the heartwood part was a new feature added to the model. Therefore, for a few trees the heartwood diameter at the highest tree height levels was less or slightly more than 25 mm and accurate reconstruction was not possible.

The knots in four logs, of one stem (total of 245 knots), were analysed manually in order to evaluate the accuracy of the reconstruction program in the identification of the knot origin position and of all segments of the same knot (I). The number of reconstructed knots in each analysed log differed from the reality only by 2 and the calculated positions for the knot origin on the stem pith showed a mean deviation of 7.8 mm.

5.2.2 Sawing simulation results

The sawing yields simulated by WoodCIM® closely followed the ones measured in industrial environment (III and IV). The results on study V showed that, for the sawing patterns tested, the program showed similar output yields when sawing only boards (57%) and over-estimated the industrial yields when sawing lumber and boards (45% vs. 53%). These production yield values remained almost the same when the number of virtual logs input as raw material increased. Also, it was possible for the pool of 35 virtual maritime pine stems to supply a good quantity of logs within the range of the industrial consumed ones (129 out of 218). However, the results should be analysed considering the

numerous factors that can influence sawing yields and comparing the industrial and virtual environment conditions. The dispersion of the sawing yields for industrial logs was much higher than for the simulated ones as virtual conditions related to the raw material and sawing process are less complex than in reality. The simulation of sawing with fixed position of the log might also create differences as in the industrial sawing the log was rotated by the operator to the best position. Previous studies showed 6% average differences in yields between worst and best rotation angles (Usenius et al. 1989). However, in the industrial environment the operator optimises more easily the sawing of smaller logs than of larger ones. Therefore for bigger logs the highest absolute differences occur when the sawing simulated yield was higher than the industrial one.

5.3 Study of raw material characteristics

5.3.1 Stem and log shape

The results in study I described the stem shape for the maritime pine trees sampled from S1 relating it with the forest production. In studies III and IV, the 35 virtual stems were crosscut into 2.6 m logs which were characterised as raw material for the sawmill industry.

The stem shape of the 20 S1 trees was analysed by studying the original 4 logs (5 m long) of each tree. Top diameters decreased with log position in the tree from an average 36 cm for butt logs to 24 cm for top logs, with 56% of the logs showing top diameters between 25 and 35 cm. Butt and top logs have the highest taper values, 13 and 11 mm/m respectively, while middle logs have taper values of 6 and 7 mm/m. The taper increases in the top log as this height level (15–20 m) is included in the dead crown zone. Maritime pine has a weak natural pruning and the death crown depth (often with big branches) is an important cause for depreciation of top logs (Tavares 1999).

The sampled trees showed different sizes in the four sites (Table 2). This resulted in logs with different average characteristics when stems were bucked to supply raw material for sawing simulation (III and IV). Figure 6 shows the average top diameter, taper, and curviness for these logs. The logs from S1 showed the highest average top diameter and lowest taper and pith curviness, as a result of the growing conditions referred to above (chapter 5.1). Site 2 showed the worst site growth (Table 2) and the logs obtained from the sampled trees had the smallest diameters. Overall, a large variation for log top diameter between different logs was found, ranging from 5 to 50 cm top. Most logs were included in the 30–35 cm (24%), 25–30 cm (21%), and 20–25 cm (20%) diameter classes. A study made on the characterisation of maritime pine logs in sawmills of different regions showed an average log diameter of about 25 cm (Reimão et al. 1994). This means that, although the sizes of S1 trees were above average, a large proportion of the bucked logs were within the range consumed by the industry.

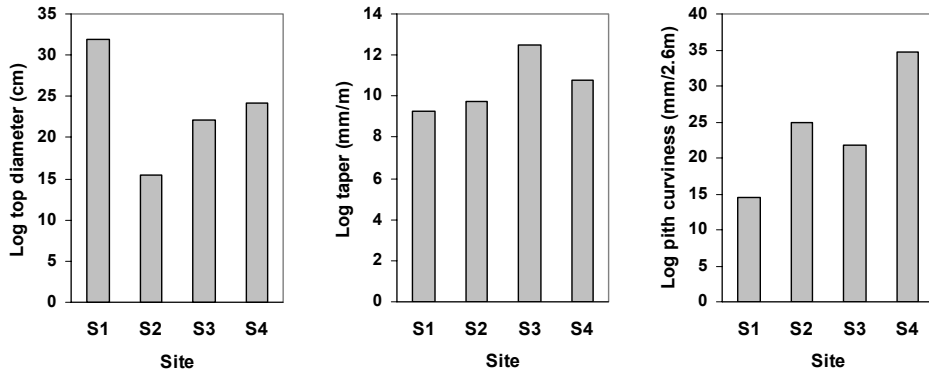

Figure 6. Average values of top diameter, taper, and pith curviness of logs from the different sites.

5.3.2 Knots

The within-tree variation of knot dimensions was studied for the 20 S1 trees up to 80% of total tree height, in average (I). This represents the commercial section of the stem and therefore the most important in terms of value yield for timber products. Although not representative for the diversity of the species, due to the small sample size, the results are indicative of the potential maritime pine knottiness and reflect the growing conditions described in chapter 5.1.

The volume proportion of knots within the stem varied from 0.07% of the butt log volume to 1.95% of the top log volume (5 m logs). The highest proportion of dead knots (38%) was found in the 3rd log (10–15 m of tree height). The proportion of the tree cross-section covered by the knot core increased linearly from the stem base (28% of the tree radius) to 55% of total tree height and thereafter remained rather constant (around 85% and 65% for the total and sound knot core, respectively) until the top of the stem. The sound knot core showed same kind of variation but the rate of increase with tree height was slower when compared to the total knot core. This stable zone corresponded approximately to the top log included in the dead crown (the first visible dry branch was located on average at 55% of total tree height). The lower part of the stem had the smallest knot core and the lowest proportion of dead knots. This stresses the importance of pruning maritime pines at early stages since this species has well branched first crown whorls and a weak natural pruning as referred to above (Tavares, 1999).

The influence of the silvicultural history of S1 trees on their knottiness was also reflected in the variation of knots' individual dimensions. The increase rate of knot dimensions was higher in the height level of 50–60% of total tree height, especially for diameter and volume (Fig. 7). Knot length and diameter increased along the stem attaining at these levels maximum average values of 12.4 and 3.2 cm respectively. These maximums are probably a response to the thinnings that

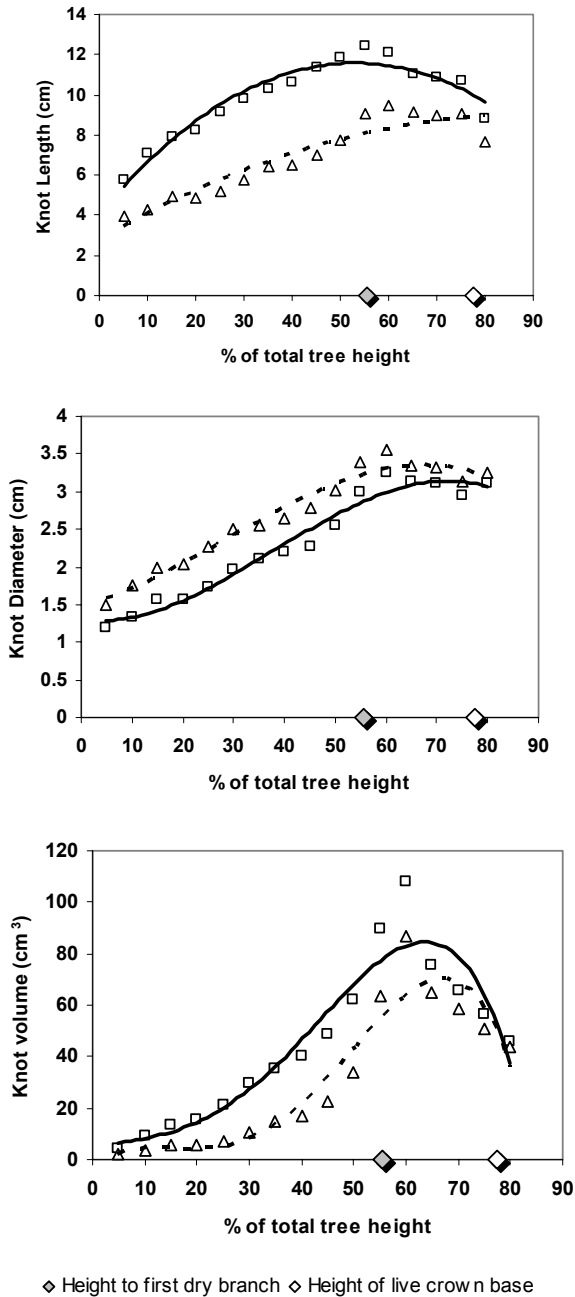

Figure 7. Average total (\square) and sound (Δ) knot lengths, diameters, and volumes as a function of relative tree height. The corresponding polynomial fitted curves are indicated by (solid line) for total knot dimensions and by (dashed line) for sound knot dimensions.

occurred when the tree height corresponded approximately to the levels of 54 to 63% of the final total tree height. According to studies on mean annual height increments for this species (Paulo and Tavares, 1996), the thinnings were made when height increments were already in the decreasing phase allowing the tree to invest more in crown and diameter growth.

5.3.3 Heartwood and sapwood

The within and between-tree variation of heartwood and sapwood found in study II for the maritime pine stems follows the results reported in the literature for pine species. The heartwood content increases with tree age and various studies found evidence that, after a certain initiation age, heartwood is formed at a constant annual ring rate (Hazenbergh and Yang 1991; Wilkes 1991; Sellin 1994; Björklund 1999; Gjerdrum 2002). In study II, the age of heartwood initiation was estimated to be 13 years through extrapolation of the second-degree polynomial fitted to the number of growth rings included in the heartwood with cambial age. Early heartwood formation phases were observed in the measured samples between 13 and 38 years. Esteves (2000) estimated heartwood initiation age for maritime pine to be around 20 years based on observations of stem discs at various height levels. For other pine species, this age is indicated in the literature to be between 9 and 30 years (Björklund 1999, Climent et al. 2003, Gjerdrum 2002, Mörling and Valinger 1999). The age of heartwood formation is usually lower when estimated by fitted models than by observation of wood discs. For the studied maritime pine trees, the heartwood formation rate was slower in younger ages with 0.5 rings per year for ages under 55 years and 0.7 rings per year between 55 and 83 years. For trees with similar ages (S2–S4), the variability in the number of annual rings within heartwood at a certain height level was quite low which supports the theory that heartwood progresses at a constant rate along the stem diameter.

In accordance with the findings for this species (Stokes and Berthier 2000) as well as for *P. sylvestris* (Björklund 1999), maritime pine sapwood width was much higher at the stem base than further up in the stem where it stabilised at an almost constant value after 2–3 m height. The sapwood width values were similar among trees in the same site except for S3 where between-tree variability was higher. This higher amount of sapwood at the tree basis might be connected to a decrease in specific conductivity in this region that is compensated by a higher sapwood area (Stokes and Berthier 2000).

The variability of heartwood dimensions was quite high, both between trees and between stands, in contrast to sapwood width which showed lower variation for trees belonging to the same stand. The heartwood diameter either decreased with stem height level or presented a maximum value at a specific height decreasing afterwards until the top of the tree (Figure 8). The latter was the typical pattern for the majority of the sampled maritime pine trees (63% of the total) and the maximum heartwood diameters were found between 1.4 m and 6.8 m. Similar profiles have been found for maritime pine in France, Spain, and Portugal

(Stokes and Berthier 2000; Berthier et al. 2001; Esteves 2000; Ezquerro and Gil 2001; Ferreira 2002) and for other pine species such as Scots pine (Björklund 1999; Mörling and Valinger 1999), Canary Island pine (Climent et al. 2003), and radiata pine (Wilkes 1991). The reason for these two patterns of heartwood vertical profile is not known although some hypotheses have been formulated in previous studies. The hypothesis made by Climent et al. (differences in crown depth result into earlier or faster heartwood formation) was not confirmed in Study II. The irregular heartwood profiles are likely to be caused by other factors, i.e. as a consequence of the increased sapwood volumes and butt swell at the stem basis. Also, it might be related with the height level of the heartwood initiation. In S1 trees, the maximum proportion of heartwood in the stem cross-section was found at 8.8 m (42% of the diameter and 18% of the cross sectional area) which corresponded to a total tree height at about 13 years of age, the age that was estimated here for heartwood initiation.

Tree variables as stem diameter, DBH and tree total height were found to correlate significantly with the heartwood content. The stem diameter was the best predictor of heartwood diameter. The fitness was done through a second-degree polynomial indicating that heartwood will be present for stem diameters above 6.8 cm and will increase in diameter by approximately 0.5 cm for each cm of stem diameter increase. Up to 50% of tree height, heartwood represents 17% of stem volume in 83 year-old trees and 12–13% in 42–55 year-old trees. Total tree height and DBH showed the highest correlation with heartwood and sapwood total volume within the tree. However, the correlations found are only indicative about the use of these two variables to predict heartwood volumes in maritime pine as the number of sampled trees was low and the variability between trees and stands as well as in heartwood contents was high. The hypothesis of predicting heartwood diameters based on stem diameters and heartwood volumes based on tree height and DBH can be very useful for the utilisation of the raw material in the wood-based industry. When the target is to maximise heartwood content in the products, the trees can be selected by DBH and height at harvest and stem bucking can be optimised taking into account the within-stem variation of heartwood (V).

5.4 Maritime pine sawing simulation

The 35 reconstructed stems were cross-cut into virtual logs to provide raw material data for the sawing simulations. Results explored in studies III to V showed the potential of the WoodCIM® sawing simulation module to study the impacts of raw material properties on the sawing yield of the conversion of maritime pine into solid wood products.

a)

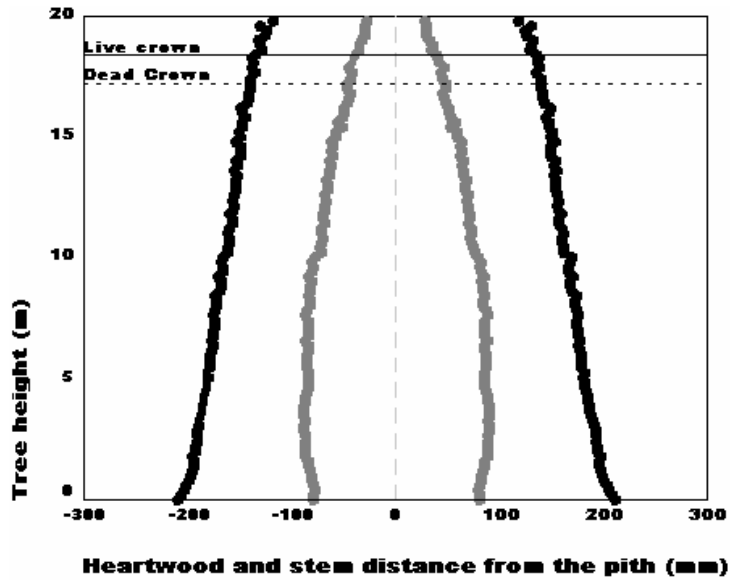

b)

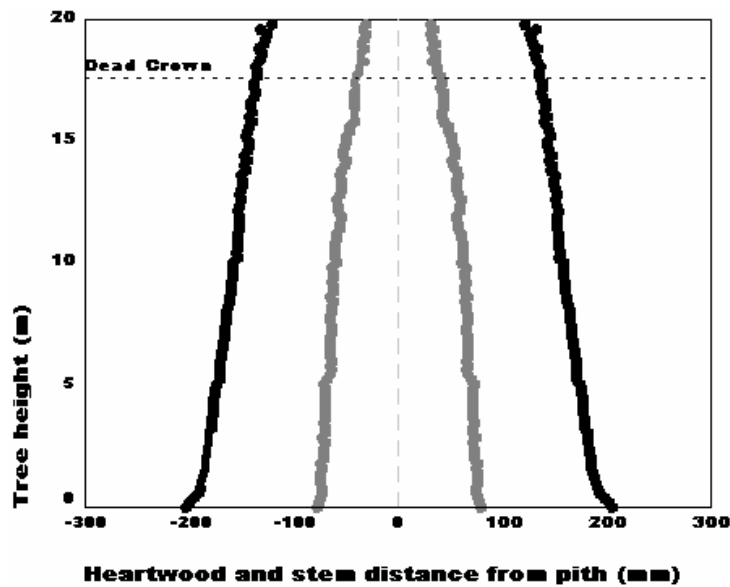

Figure 8. Symmetrical presentation of axial variation of stem and heartwood profiles in two trees showing the two different patterns: (a) heartwood with a maximum diameter at a specific height and (b) decreasing heartwood diameter along the stem.

5.4.1 The impact of log shape and internal knots on sawing yield

With the information from the sawing simulation, it was possible to evaluate volume and value yields of sawing and the impact of log characteristics, knots, and process parameters (III). The variability of the raw material characteristics described above in Section 5.2, mainly the differences of log shape and internal knottiness with sampled site and along the tree height, was reflected in the results.

When no specific quality requirements or prices were defined, the volume yield for a batch of 216 2.6m logs was 51.6%. The volume yield increased with diameter to maximum values of 59% corresponding to the sawing of logs in the 40–45 cm and 45–50 cm top diameter classes. The variability of the values inside each diameter class was high, especially in the range of diameters between 10 and 25 cm due to the different origin of the trees and the variability in log taper and curviness. When the sawing of a batch of logs from the same site was simulated, the best yield (52%) was obtained with the logs from Leiria (S1) in accordance with the larger diameters and lower pith curviness and taper as shown in Figure 6.

The software searches for a solution maximising the total value of the products received from the same log by taking into account each single knot inside the log and the rules for the grading of products. Product grades are defined by number, size, and quality of knots and proportion of wane allowed. The final sawing solution is very much dependent on the prices of products defined by dimensions and grades. In spite of small differences in volume yield using determined quality specifications for the boards (51.6% vs. 50.9%), the value yield (sawn products and by-products) increases strongly with log diameter class from a value of 35 € per log m³ for the 5–10 cm diameter range to 105 €/m³ – 107 €/m³ for the 40–45 and 45–50 cm diameter ranges.

Figure 9 shows the grade distribution of the sawn boards. First grade boards were 79% of the total volume of boards when all the logs were sawn together. A higher proportion of 1st grade boards was obtained from logs from site S1 where 80% of the board's volume were included in the best grading class while for logs from the other sites first grade boards corresponded to only 58% of the total boards volume. This large difference in the yields for first quality boards between sites is a result of the long rotation, pruning, and thinning program in site S1 that allows obtaining large logs with a low proportion of knots (I). Concerning the log position in the stem, the yield decreased from butt to top logs due to the diameter decrease and knot volume proportion increase, as shown in study I. In the case of S3 trees, the yield of butt logs was similar to middle logs. For these trees, butt swell was very evident and taper values were high. A sawing simulation was done with the same input data however cross cutting of the first log started 1m from the normal stump height in order to avoid butt swell influence. In this case the results showed 8% increase on average in the sawing yields for butt logs.

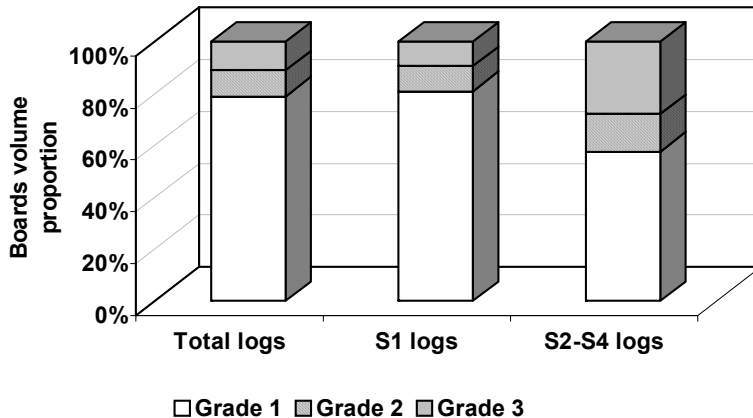

Figure 9. Volume proportion of 25 mm boards by quality grades in value optimised sawing simulations for the total of the logs, for S1 logs, and for S2, S3, and S4 logs. Relative selling prices of boards: 1st grade 100, 2nd grade 73, and 3rd grade 57.

5.4.2 The impact of resin tapping on sawing yield

The estimation of the impacts caused by the resin tapping of maritime pine trees was possible by comparing the sawing yields of resin tapped logs with the sawing simulation performed on a sample of virtual logs matching the dimensions to the industrial ones (IV). Resin tapping resulted in a loss of 11% on the sawing yields (44% vs. 55%). This loss was higher in the larger logs as they normally suffer more severe tapping. In most cases the stem area affected by the resin tapping is outside the knot core zone. Thus, one should expect an even higher value yield loss as this waste zone corresponds to the best board grades.

5.4.3 Production of heartwood containing components

Study V provided an overview of the potential to produce heartwood products from maritime pine and variables influencing it. At this stage, the results should be analysed in a theoretical context due to limitations of the simulation software to the sawing of heartwood. The WoodCIM® software was not designed to include heartwood as an input parameter or as a quality feature in the output (Usenius 1999, 2000). Therefore, the heartwood was taken in the input as an individual entity, separate from the log. The full utilization of the heartwood was possible by allowing wane in the products, i.e. at least one face of the component included in the heartwood being the remaining volume in the sapwood (Figure 5). This sawing procedure is a virtual concept and in a real industrial situation the process would be to saw the whole log and subsequently use the heartwood content of sawn products as a grading criteria option. This means that sapwood products will also be obtained and these have to be taken into account for an overall economic analysis. However, the differences between simulation and industrial reality are systematic for all logs and should not affect the impact

analysis of the different variables in the sawing yield of heartwood products. Windows and glued laminated boards were chosen as products due to the potential of increasing benefits and market share in case their production would be based on heartwood components.

The results obtained showed that yields of heartwood products for some logs could attain 13% and 16% of log volume respectively for glued laminated boards and window components. The yield was highly variable with the log variables such as dimensions, original position in the stem and age, as well as with heartwood and product variables.

Correlation analysis indicated that log and heartwood top diameters and log position in the tree were the variables that had the greatest impact on the sawing yield (correlation coefficients of 0.73, 0.88, and -0.4 respectively). For the sawing simulation of glued laminated components, yield of heartwood products above 10% of log volume only occurred for logs from the S1 stand, corresponding to the older trees. Since in maritime pine heartwood tapers fast, the position of the log in the stem (e.g. being a butt or a top log) is very significant. The highest yields were obtained when sawing 3 m logs, with top diameter above 375 mm and from the first 9 m of the stem of these trees. This stresses the importance of including a special selection of raw material within the log quality grading when the target is the production of heartwood products. The yield obtained did not show significant differences with log length. The slightly better yields obtained for the 3 m logs (5.4% batch yield against 4.8% in 2 m logs and 5.0% in 4 and 5 m) probably resulted from the fact that these logs better fit the vertical heartwood profiles found for this species (II).

Figure 10 shows the yield of heartwood products in log volume (Y_{log}) for glued laminated boards as a function of heartwood top diameter (a) and log top diameter (b). The minimum diameter under which it was not possible to saw heartwood components (0% yield) or when the yields were low was around 300 mm of log top diameter and 100 mm of heartwood top diameter. These are in accordance with the function found in study II to relate heartwood and stem diameters. Also, Toverød et al. (2003) found log diameter as the most important variable for yield variation when sawing heartwood products. However, the logs for production of heartwood components should not be selected only based on the log and heartwood diameter, even if these were the variables with the highest influence. Log selection for heartwood products will produce the highest potential yields when all the above variables are considered. A good log grading targeting the sawing optimisation of these products will therefore be achieved through an efficient traceability system and by the adaptation of machine vision systems for detecting heartwood, e.g. x-ray (Oja et al. 2001, Grundberg 1999).

The study of the potential for producing heartwood products is particularly important for maritime pine. In fact, in the global wood market maritime pine cannot compete with other species for the mass production of sawn products. Production with high quality requirements and higher added value is needed to maintain the competitiveness of solid wood products from this species.

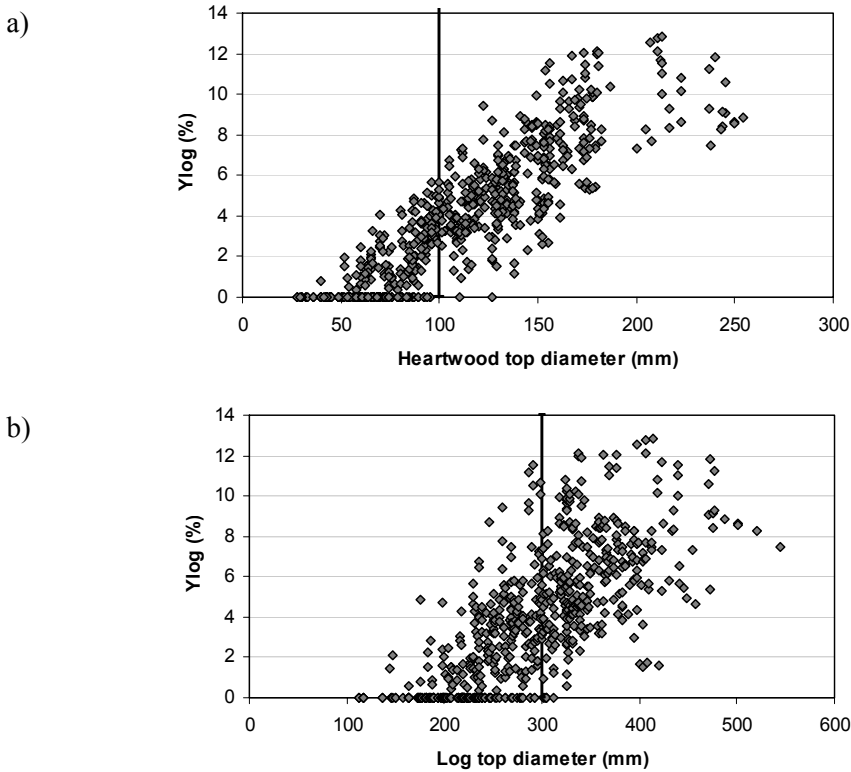

Figure 10. Yield of heartwood components in log volume (Y_{log}) for glued laminated boards as a function of heartwood top diameter (a, $R^2 = 77\%$) and log top diameter (b, $R^2 = 53\%$).

The results about the influence of the components dimensions on the sawing yields indicate that better yields were achieved with smaller components since these fit better the reduced heartwood volume. However, it was the change of quality requirements regarding the presence of knots that had the greatest impact on the yield and product dimensional assortment. The yield (Y_{log}) was drastically reduced with the increase of the number of defect-free faces in the component. It is possible to produce defect-free components though, in this case, 38% of the components had the smallest allowed width and length (75 and 400 mm, respectively). The results in studies I and II showed that most of the heartwood volume was included in the knot core volume. The production of knot-free components was then mainly dependent on the inter-whorl length. For S1 trees, the knot core varied from 28% of tree diameter at the stem bottom to 84% of tree diameter at 70% of total tree height (I). For the same trees, the proportion of heartwood varied from 34% of the stem diameter at the bottom, to 24% at the top (II). Finger-joining techniques might be applied in this case to produce defect-free components with the required dimensions.

6. Conclusions

The WoodCIM® stem/log reconstruction and sawing simulation software modules proved to be useful tools to increase the knowledge on maritime pine wood characteristics and to develop sawing studies for this species. This allowed to evaluate the impact of raw material and process characteristics on the production performance. The reconstruction provided a good description for log and heartwood shape with only small deviations between simulated and measured diameters and a good identification of individual internal knots. The sawing simulation showed potential to optimise the operating instructions in the sawing process and it was able to reproduce the industrial sawing of maritime pine.

Although not representative of the variability for the species, the pool of virtual stems constructed in this thesis is a powerful source of data to study maritime pine wood. This is important as there are very few studies available in the international literature concerning the characterisation of this species as a raw material to the wood industries. The stem reconstruction technique adapted for this species included the representation of stem shape and internal knots. The reconstruction of the heartwood part was a new feature added to the model and it was completely developed within this study. This allowed obtaining detailed data on heartwood and sapwood variability along stem height and also their radial variation in the cross-section. Also, it was possible to use the heartwood part as input raw material for the sawing simulation. Although developed here for maritime pine, this technique can also be adapted to the study of heartwood and sapwood in other species.

Specifically, this thesis analysed the evolution of stem shape, individual knot dimensions, and heartwood/sapwood contents with tree height as internal characteristics of the pine stems. The virtual stems were the raw material input for the sawing-simulation studies and the output results clearly showed the impact of these characteristics on value and volume yields. Production yields were higher for logs from the first half of the stem as diameters were large and the taper was smaller when compared to top logs, especially when butt swell was avoided. According to the knot core profile found, butt logs also showed the highest value yields. However, when the target was to maximise the production of heartwood containing components, maximum yields were obtained with logs bucked between 3 and 9 m height as this better fits the heartwood profile found for most of the studied trees. The results can contribute to better selection of the raw material in order to optimise the different wood yields for target products of this species. The study of the maritime pine potentialities for producing heartwood containing components showed that this is possible with an efficient log grading system and additional efforts for selecting heartwood pieces after the conversion. However, the general yields of heartwood products are low and the production should carefully integrate the remaining products from sapwood.

The results also showed the impact of the between-stand variability of wood characteristics on the sawing yields. Raw material harvested from stands with long rotation and management plans (especially pruning and thinning programs) showed the best results, mainly concerning high-quality grades output on sawing as well as the best heartwood sawing yields. Although the present studies did not include any economic analysis, the results are a clear indication that industry should press foresters to supply raw material from stands with longer rotations and better management when the target strategy is the production of high quality products.

The results in this study contribute to the basic scientific knowledge about maritime pine concerning the variations of wood characteristics and their influence on sawing yield outputs, namely within-tree and between-tree variability of stem shape, internal knot dimensions, and heartwood and sapwood development. Also, the results are a contribution to the improvement of this species' utilisation as a raw material for the solid wood industry and can support further development of industrial applications for defect detection and sawing simulation. The WoodCIM® sawing simulation program adapted in this study for maritime pine can support product development studies as well as the development of real-time applications for the sawmill and secondary conversion industries.

7. Further work

The conclusions of this thesis and the results found in the studies presented here suggest that further research is needed, especially concerning the following issues:

- Sampling of maritime pine trees should be increased in order to account for the observed between-tree and between-stand variability. The increase in the number of sample trees and sites should cover a wider range of reported growth conditions and silvicultural management programs. In this way, it would be possible to study the impact of specific forest variables, such as tree provenance, cambial age, density, thinning and pruning on the raw material characteristics and conversion value yield.
- Further analysis on larger samples is also required for a full validation of the accuracy of the reconstruction model, especially concerning dimensions of individual knots and sawing simulation output. Further work should be performed to validate the output quality grades of the sawn products.
- The data associated with the heartwood reconstruction supplies a detailed description for the cross-sections for each 50 mm of stem height. Therefore it will be possible studying the radial variation of this xylem zone in maritime pine. Also, in order to further study the age-based development process of heartwood, future studies should include measurements in a wider range of tree age and the upper parts of the stem with low heartwood contents. For the latter case, the reconstruction of the heartwood would require the use of thinner flitches for data acquisition.
- The results obtained support further development of the WoodCIM® sawing simulation program for research purposes and also for development of industrial applications. The new feature added in this thesis to the stem reconstruction model, the heartwood core, should be included as an input quality requirement for sawing simulation. Information concerning raw material characteristics other than knots, such as resin pockets and pith volume, was also stored and in the future this information could be included in the stem reconstruction and accounted for in the sawing simulation.
- Finally, another important task would be to connect the results with economic and marketing studies. The economic value of wood raw material and final products are very strongly connected. In a future work it is important to create knowledge in order to achieve a good balance between the different parts in the wood conversion chain. Also, research of potential sawing yields of new high added-value products, as for the heartwood containing components, should be developed within feasibility studies and including marketing research.

References

- Alves** A.A.M. (1982). Técnicas de Produção Florestal. Instituto Nacional de Investigação Científica, Lisboa. (*In Portuguese.*)
- Bamber** R.K. (1976). Heartwood, its function and formation. *Wood. Sci. Technol.* 10: 1–8.
- Bamber** R.K. and Fukazawa K. (1985). Sapwood and heartwood: a review. *For. Abstr.* 46(9): 567–580.
- Bergström** B. (2000). Aspects on heartwood formation in Scots pine. Doctoral thesis. Dept. of Forest Genetic and Plant Physiology, Swed. Univ. of Agri. Sciences, Umeå. 27 p.
- Berthier** S., Kokutse A. and Stokes A. (2001). Irregular heartwood formation in maritime pine (*Pinus pinaster* Ait.): consequences for biomechanical and hydraulic tree functioning. *Ann. Bot.* 87: 10–25.
- Bhandarkar** S.M., Faust T.D. and Tang M. (1999). CATALOG: a system for detection and rendering of internal log defects using computer tomography. *Mach. Vision & App.* 11: 171–190.
- Björklund** L. (1997). The interior knot structure of *Pinus sylvestris* stems. *Scand. J. For. Res.* 12: 403–412.
- Björklund** L. (1999). Identifying heartwood-rich stands or stems of *Pinus sylvestris* by using inventory data. *Silva Fenn.* 33(2): 119–129.
- Björklund** L. and Petersson H. (1999). Predicting knot diameter of *Pinus sylvestris* in Sweden. *Scand. J. For. Res.* 14: 376–384.
- Blaise** F., Saint-André L., Leban J.M., Gégout J.C. and Hervé J.C. (2002). Connection between forest inventory data and geographic information systems for assessing timber value at the stand level. IUFRO WP S5.01.04 “Connection between forest resources and wood quality: modelling approaches and simulation software”. British Columbia. Ed. G. Nepveu, INRA, Nancy. Pp. 583–594.
- Carvalho** A. (1997). Madeiras Portuguesas, Vol. II. Estructura Anatómica, propriedades, utilizações. Ed: Direcção Geral das Florestas, Lisboa. (*In Portuguese.*)
- CESE** (1996). *O sector florestal português*. Documento de apoio ao seminário do CESE, Conselho Ensino Superior Empresa. Grupo e trabalho sobre o sector florestal. Póvoa do Varzim. (*In Portuguese.*)
- Chang** S.J., Olson J.R. and Wang P.C. (1989). NMR imaging of internal features of wood. *Forest Prod. J.* 39(6): 43–49.
- Chiorescu** S. and Grönlund A. (2000). Validation of a CT-based simulator against a sawmill yield. *Forest Prod. J.* 50(6): 69–76.
- Climent** J., Gil L. and Pardos J. (1993). Heartwood and sapwood development and its relationship to growth and environment in *Pinus canariensis* Chr.Sm ex DC. *For. Ecol. Manage.* 59: 165–174.
- Climent** J., Chambel M.R., Pérez E., Gil L. and Pardos J. (2002). Relationship between heartwood radius and early radial growth, tree age, and climate in *Pinus canariensis*. *Can. J. For. Res.* 32: 103–111.

- Climent J.**, Chambel M.R., Gil L. and Pardos J.A. (2003). Vertical heartwood variation patterns and prediction of heartwood volume in *Pinus canariensis* SM. *For. Ecol. Manage.* 174: 203–211.
- Colin F.** and Houllier F. (1991). Branchiness of Norway spruce in northeastern France: modelling vertical trends in maximum nodal size. *Ann. Sci. For.* 48: 679–693.
- Colin F.** and Houllier F. (1992). Branchiness of Norway spruce in northeastern France: predicting the main crown characteristics from usual tree measurements. *Ann. Sci. For.* 49: 511–538.
- Cruz, H.**, Nunes L. and Machado J.S. (1998). Update assessment of Portuguese Maritime Pine Timber. *Forest Prod. J.* 48(1): 60–64.
- Cummins L.K.** and Culbertson D.D. (1972). Sawmill simulation model for maximizing log yield values. *Forest Prod. J.* 22(10): 34–40.
- Desch H.E.** and Dinwoodie J.M. (1996). Timber – Structure, Properties, Conversion and Use. 7th edition, Macmillan Press. 306 p.
- DSIR** (1960). A handbook of softwoods. Department of scientific and industrial research – Forest Products Research. H.M Stationery Office.
- Esteves B.** (2000). Influência do cerne na composição química e na deslenhificação para o Pinheiro (*Pinus pinaster* Ait.). Masters degree thesis. Instituto Superior de Agronomia, Universidade Técnica de Lisboa. 88 p. (*In Portuguese with English summary.*)
- European Standardization Committee (1993). **ENV1995-1-1**: Eurocode 5 – Design of timber structures. Part 1.1: general rules and rules for buildings. CEN, Brussels, Belgium.
- Ezquerria F.** and Gil L. (2001). Wood anatomy and stress distribution in the stem of *Pinus pinaster* Ait. *Investigación Agraria. Sist. y Recursos For.* 10(1): 165–209.
- Ferreira S.K.S.** (2002). Análise de rendimentos mássicos da indústria de serração do pinheiro bravo. Relatório do trabalho de fim de curso de Engenharia Florestal – Instituto Superior de Agronomia, Universidade Técnica de Lisboa, Lisboa. 65 p. (*In Portuguese.*)
- Funk J.W.**, Brunner C.C., Punches J.W. and Forrer J.B. (2002). Simulated sawing of real log images: linking wood quality and product potential. IUFRO WP S5.01-04 “Connection between forest resources and wood quality: modelling approaches and simulation software”. British Columbia. Ed. G. Nepveu, INRA, Nancy. Pp. 504–510.
- Gjerdrum P.** (2002). Sawlog quality of Nordic softwood – measurable properties and quantitative models for heartwood, spiral grain and log geometry. Doctoral thesis. Dept. of Forest Sciences, Agri. Univ. of Norway, Ås. 21 p.
- Gomes S.** (1999). Leiria National Forest – More than a hundred years producing quality timber. *In: Proceedings of COST E10 2nd Workshop – Wood properties for industrial use.* Ed. EFN, Mafra. Pp. 90–91.
- Grönlund A.** (1989). Yield of trapezoidal sawing and some other sawing methods. *Forest Prod. J.* 39(6): 21–24.
- Grundberg S.** (1999). An X-ray LogScanner – a tool for control of the sawmill process. Doctoral thesis. Division of Wood Technology, Luleå Univ. Techn. 30 p.

- Hagman** O. and Grundberg S. (1995). Classification of Scots pine (*Pinus sylvestris*) knots in density images from CT scanned logs. *Holz als Roh- und Werkstoff* 53: 75–81.
- Hazenberg** G. and Yang K.C. (1991). The relationship of tree age with sapwood and heartwood width in black spruce, *Picea mariana* (Mill.) B.S.P. *Holzforschung* 45: 417–320.
- Heräjärvi** H. (2002). Modelling of internal knot characteristics of mature Finish *Betula pendula* and *Betula pubescens*. Simulated sawing of real log images: linking wood quality and product potential. IUFRO WP S5.01-04 “Connection between forest resources and wood quality: modelling approaches and simulation software”. British Columbia. Ed. G. Nepveu, INRA, Nancy. Pp. 85–93.
- Hillis** W.E. (1987). Heartwood and tree exudates. Berlin: Springer Verlag. 268 p.
- Houllier** F., Leban J.-M. and Colin F. (1995). Linking growth modelling to timber quality assessment for Norway spruce. *For. Ecol. Manag.* 74: 91–102.
- Ikonen** V.-P., Kellomäki S. and Peltola H. (2003). Linking tree stem properties of Scots pine (*Pinus sylvestris* L.) to sawn timber properties through simulated sawing. *For. Ecol. Manage.* 174: 251–263.
- INRA** (1994). Upgrading of Southern European pines. Final report, Project MA2B-CT91-0040, INRA Bordeaux. Ed. M. Arbez.
- INRA** (2000). Modèle de croissance et qualité pour le Pin maritime (tranche 1). Second rapport d’avancement des travaux. Ed. F. Colin. 25 p. (*In French.*)
- Instituto Português de Qualidade (IPQ) (1994). **NP4305**: Maritime pine sawn timber for structures. Visual strength grading. Lisbon, Portugal. (*In Portuguese.*)
- Kaplan** R.S. and Norton D.P. (1996). The Balanced Scorecard: Translating strategy into action. Harvard Business School Press, Boston.
- Kellomäki** S., Ikonen V.-P., Peltola H. and Kolström T. (1999). Modelling the structural growth of Scots pine with implications for wood quality. *Ecological Model.* 122: 117–134.
- Leban** J.-M. and Duchanois G. (1990). SIMQUA: un logiciel de simulation de la qualité du bois. *Ann. Sci. For.* 47: 483–493. (*In French with English summary.*)
- Leban** J.-M., Daquitaine R., Houllier F. and Saint-André L. (1996). Linking models for tree growth and wood quality in Norway spruce. Part I: Validation of predictions for sawn boards properties, ring width, wood density and knotiness. IUFRO WP S5.01-04 “Connection between Silviculture and wood quality through modelling approaches and simulation softwares”. Ed. G. Nepveu, INRA, Nancy. Pp. 214–219.
- LNEC** (1997). Pinheiro bravo para estruturas. Séries Madeira para construção, n° 2. (*In Portuguese.*)
- Lemieux** H., Samson M. and Usenius A. (1997). Shape and distribution of knots in a sample of *Picea abies* logs. *Scand. J. For. Res.* 12: 50–56.
- Lönner** G. and Björlund L. (1999). Value optimised cross-cutting and sawing patterns applied on tree models: some cases. Proc. of 3rd workshop on "Connection between Silviculture and Wood Quality through Modelling Approaches and Simulation Softwares". La Londe–Les-Maures. Ed. G. Nepveu, INRA, Nancy. Pp. 542–548.

- Machado** J.S. (2000). Avaliação da variação das propriedades mecânicas de pinho bravo (*Pinus pinaster* Ait.) por meio de ultra-sons. Doctoral thesis. Instituto Superior de Agronomia, Universidade Técnica de Lisboa. 221 p. (In Portuguese with English summary.)
- McAdoo** J.C. (1969). Computer simulation of small-log mill processing. *Forest Prod. J.* 9(4): 34–35.
- Moberg** L. (1999). Models of knot properties for Norway spruce and Scots pine. Doctoral thesis. Dept. of Forest Management and Products, Swed. Univ. of Agri. Sciences, Uppsala. 24 p.
- Morales** S., Fernández P., Guesalaga A. and Irarrazaval P. (2002). 3D Internal tree structure modelling using Magnetic Resonance Imaging (MRI) IUFRO WP S5.01-04 “Connection between forest resources and wood quality: modelling approaches and simulation software”. British Columbia. Ed. G. Nepveu, INRA, Nancy. Pp. 254–264.
- Mäkelä** A. and Mäkinen H. (2003). Generating 3D sawlogs with a process-based growth model. *Forest Ecol. Manage.* 184: 337–354.
- Mäkinen** H. and Colin F. (1998). Predicting branch angle and branch diameter of Scots pine from usual tree measurements and stand structural information. *Can. J. For. Res.* 28: 1686–1696.
- Mäkinen** H. and Colin F. (1999). Predicting the number, death, and self-pruning of branches in Scots pine. *Can. J. For. Res.* 29: 1225–1236.
- Mäkinen** H., Ojansuu R., Hynynen J. and Niemistö P. (2002). Predicting branch properties of Silver birch (*Betula pendula* Roth.) from simple stand and tree properties. IUFRO WP S5.01-04 “Connection between forest resources and wood quality: modelling approaches and simulation software”. British Columbia. Ed. G. Nepveu, INRA, Nancy. Pp. 265–273.
- Mörling** T. and Valinger E. (1999). Effects of fertilization and thinning on heartwood area, sapwood area and growth in Scots pine. *Scand. J. For. Res.* 14: 462–469.
- Occena** L. G. and Tanchoco J.M.A (1988). Computer graphics simulation of hardwood log sawing. *Forest Prod. J.* 38(10): 72–76.
- Occena** L.G. and Schmoldt D.L. (1996). GRASP – A prototype interactive graphic sawing programme. *Forest Prod. J.* 46(11/12): 40–42.
- Oja** J. (1997). Measuring knots and resin pockets in CT-images of Norway spruce. Division of Wood Technology, University of Technology, Luleå, Licenciante thesis, Skellefteå. 6 p.
- Oja** J., Grundberg S. and Grönlund A. (2001). Predicting the stiffness of sawn products by X-ray scanning of Norway spruce saw logs. *Scand. J. For. Res.* 16: 88–96.
- Paulo** M.J. and Tavares M. (1996). Policiclismo do crescimento do pinheiro bravo das dunas do litoral português. *Silva Lusitana* 4: 25–38. (In Portuguese with English summary.)
- Pietilä** J. (1989). Shape of Scots pine knots close to the stem pith. *Silva Fennica* 23(4): 287–299.
- Pnevmaticos** S.M., Dress P.E. and Stocker F.R. (1974). Log and sawing simulation through computer graphics. *Forest Prod. J.* 24(3): 53–55.

- Reimão D.**, Tavares M., Carvalho A., Leitão M., and Palma A. (1994). Base-line da indústria de serração de madeiras resinosas em Portugal. *In: Actas do III Congresso Florestal Nacional, Os recursos florestais no desenvolvimento rural*, Ed. SPCF Lisboa. Pp. 207–231. (*In Portuguese.*)
- Richards D.B.** (1973). Hardwood lumber yield by various simulated sawing methods. *Forest Prod. J.* 23(10): 50–58.
- Schmoldt D.**, Li P. and Araman P. (1996). Interactive simulation of hardwood log veneer slicing using CT images. *Forest Prod. J.* 46(4): 41–47.
- Sellin A.** (1994). Sapwood-heartwood proportion related to tree diameter, age, and growth rate in *Picea abies*. *Can. J. Bot.* 51: 737–741.
- Shinozaki K.**, Yoda K., Hozumi K. and Kira T. (1964). A quantitative analysis of plant form – the pipe model theory. I. Basic Analyses. *Japanese J. of Eco.* 14: 95–105.
- Song T.** (1987). Optimization of sawing decision making through computer simulation. Laboratory of mechanical wood technology, Helsinki University of Technology, Licenciate thesis, Espoo. 109 p.
- Song T.** (1998). Tree stem construction model for “Improved spruce timber utilisation” project. VTT Building Technology, internal report. Helsinki. 20 p.
- Stokes A.** and Berthier S. (2000). Irregular heartwood formation in *Pinus pinaster* Ait. is related to eccentric, radial, stem growth. *For. Ecol. Manage.* 135: 115–121.
- Tavares M.** (1999). Maritime pine wood quality in Portugal, a few reasons responsible for some of its characteristics and defects. COST E10 2nd Workshop – Wood properties for industrial use. Ed. EFN, Mafra. Pp. 81–87.
- Tavares M.** and Campos J. (2000). Optimisation of biometric data collecting on video images of breaked up trees, using PhotoModeler and AutoCAD software *in* proceedings of COST E10 3rd Workshop – Measuring of wood properties, grades and qualities in the conversion chains and global wood chain optimisation. Ed. A. Usenius. VTT, Helsinki.
- Taylor A.M.**, Gartner B.L. and Morrell J.J. (2002). Heartwood formation and natural durability – a review. *Wood Fiber Sci.* 34(4): 587–611.
- Thawornwong S.**, Occena L.G. and Schmoldt D.L. (2003). Lumber value differences from reduced CT spatial resolution and simulated log sawing. *Comput. Electron. in Agric.* 41: 23–43.
- Todoroki C.L.** (1990). Autosaw systems for sawing simulation. *New Zealand J. For. Sci.* 20(3): 332–343.
- Todoroki C.L.** (1996). Developments of the sawing simulation software, AUTOSAW linking wood properties, sawing and lumber end use. IUFRO WP S5.01-04 “Connection between forest resources and wood quality: modelling approaches and simulation software”. Kruger National Park. Ed. G. Nepveu, INRA, Nancy. Pp. 241–247.
- Tomé M.**, Páscoa F., Marques C.P. and Tavares M. (1998). Valorização do Pinhal Bravo – Intensificação cultural, modelação do crescimento e produção, gestão e planeamento estratégico. Final report project PRAXIS 3/3.2/FLOR/2120/95. Lisboa. Pp. 24–30. (*In Portuguese.*)

- Toverød** H., Øvrum A. and Flæte P.O. (2003). Uttak av furu kjerneved. Oppdragsrapport 1/03. Skogforsk. (*In Norwegian.*)
- Tsolakides** J. (1969). A simulation model for log yield study. *Forest Prod. J.* 19(07): 21–26.
- Usenius** A. (1980). Sahausasetteen simulointimalli. Doctoral thesis, VTT, Technical Centre of Finland, Wood laboratory, Tiedonanto 5. 178 p. (*In Finnish.*) ISBN 951-38-1015-1
- Usenius** A. (1999). Wood conversion chain optimisation. IUFRO WP S5.01-04 “Connection between forest resources and wood quality: modelling approaches and simulation software”. La Londe–Les-Maures. Ed. G. Nepveu, INRA, Nancy. Pp. 542–548.
- Usenius** A. (2000). WoodCim® - Integrated planning and optimizing system for sawmilling industry. VTT Building Technology, internal report. 8 p.
- Usenius** A., Sommardahl K.O. and Song T. (1989). Puuraaka-aineen optimaalinen käyttö. Final internal report, VTT, Technical Centre of Finland. 209 p. (*In Finnish.*)
- Usenius** A. and Song T. (1996). Relating the product specification to the value yield in the wood conversion. IUFRO WP S5.01-04 “Connection between forest resources and wood quality: modelling approaches and simulation software”. Kruger National Park, Aug. Pp. 214–219.
- Verkasalo** E., Sairanen P., Kilpeläinen H. and Maltamo M. (2002). Modelling the end-use based value of Norway spruce trees and logs by using predictors of stand and tree levels. IUFRO WP S5.01-04 “Connection between forest resources and wood quality: modelling approaches and simulation software”. British Columbia. Ed. G. Nepveu, INRA, Nancy. Pp. 265–273.
- Vestøl** G.I., Colin F. and Loubère M. (1999). Influence of progeny and initial stand density on the relationship between diameter at breast height and knot diameter of *Picea abies*. *Scand. J. For. Res.* 14: 470–480.
- Vestøl** G.I., Høibø O.A. (2000). Internal distribution of sound and dead knots in *Picea abies* (L.) Karst. *Holz als Roh- und Werkstoff* 58: 107–114.
- Wagner** F.G., Taylor F.W., Ladd D.S., McMillin C.W. and Roder F.L. (1989). Ultrafast CT scanning of an oak log for internal defects. *Forest Prod. J.* 39(11/12): 62–64.
- Wilkes** J. (1991). Heartwood development and its relationship to growth in *Pinus radiata*. *Wood Sci. Technol.* 25: 85–90.
- Zhang** S.Y. (1997). Wood quality: its definition, impact, and implications for value-added timber management and end uses. CTIA/IUFRO International wood quality workshop – Timber management toward wood quality and end-product value. Quebec, Aug. Pp. 117–139.
- Zobel** B.J. and Buijtenen J.P. (1989). Wood variation – its causes and control. Berlin: Springer Verlag. 363 p.
- Åstrand** E. and Rönnqvist M. (1994). Crosscut optimization of boards given complete defect information. *Forest Prod. J.* 44(2): 15–24.

Original article

Analysis of log shape and internal knots in twenty Maritime pine (*Pinus pinaster* Ait.) stems based on visual scanning and computer aided reconstruction

Isabel Pinto^{a*}, Helena Pereira^b and Arto Usenius^a

^a VTT Building and Transport, PO Box 1806, 02044 VTT, Finland

^b Centro de Estudos Florestais, Instituto Superior de Agronomia, 1349-017 Lisboa, Portugal

(Received 1 February 2001; accepted 21 January 2002)

Abstract – A mathematical reconstruction of Maritime pine (*Pinus pinaster* Ait.) was produced using the WoodCim[®] software based on input information obtained by image scanning of twenty 83 years old stems sampled in Portugal. The application of the reconstruction software resulted in 3D and 2D representations for logs and trees that allowed the visual appraisal of external shape as well as of the internal knot architecture. Information on tree geometry (i.e. taper) and knot parameters (i.e. knot length, diameter and volume) and on their variation with tree height could be obtained from the reconstructed logs and stems and may be incorporated in sawing yield studies through simulation as well as in raw material characterisation studies. In the studied trees, the average volume percentage of knots varied from 0.07% for butt logs to 1.95% for top logs. The knot core represented, in % of the tree radius, from 28% at the stem bottom to 84% at 70% of total tree height.

maritime pine / modelling / wood quality / knot dimensions / image analysis

Résumé – Caractérisation de la forme des fûts et des noeuds dans 20 arbres de pin maritime (*Pinus pinaster* Ait.) après analyse d'image et reconstruction par logiciel. La reconstruction mathématique d'arbres de pin maritime (*Pinus pinaster* Ait.) a été faite avec le logiciel WoodCim[®] ayant pour base l'information obtenue par l'analyse d'image de vingt fûts de 83 ans échantillonnés au Portugal. L'application des modèles de reconstruction a produit des représentations en 3D et 2D des fûts et billes qui ont permis l'appréciation visuelle de leur forme et de l'architecture intérieure de la nodosité. Des données sur la géométrie de l'arbre (i.e. décroissance de la tige) et les caractéristiques des noeuds (i.e. longueur, diamètre et volume), ainsi que sur leur variation en hauteur dans l'arbre, ont pu être obtenues à partir de la reconstruction, permettant leur incorporation dans des études d'optimisation de sciage par simulation ou de caractérisation de la qualité du bois. Dans les arbres étudiés, le volume de noeuds a varié de 0,07 % pour les billes de pied jusqu'à 1,95 % pour les billes de cime. Le centre nodeleux a augmenté de 28 % du radius à la base, jusqu'à 84 % à 70 % de la hauteur totale.

pin maritime / modélisation / qualité du bois / dimension des noeuds / analyse d'image

1. INTRODUCTION

Maritime pine (*Pinus pinaster* Ait.) spreads naturally in the Mediterranean regions of France, Spain and Italy (subspecies *pinaster*) and in the Atlantic influenced regions of Portugal, Spain and France (subspecies *atlantica*). In the last decades this species was introduced with success in plantations in South Africa, New Zealand and Australia. In Portugal, it is the most important species with more than 1 million ha (ca. 30% of the total Portuguese forest area) concentrated mostly in the central part of the country. Pinewood is the primary raw material for the saw milling, particleboard and plywood industries. The main uses concerns sawn timber products.

The optimising of the activities in the wood conversion chain, from the forest producers to the sawmills, secondary wood processing industries and further to the consumers of the

final products, requires modelling and simulation tools producing information for selection and processing of the wood raw material. In the sawmill, computer simulation provides the possibility to obtain information on different production options for a set of logs.

In this context the recent development of wood scanning technology and the progress in research on defect detection have contributed to tree modelling and sawmilling optimisation and simulation procedures [6, 22, 27, 28]. The mathematical reconstruction of logs and trees based on scanning technology can now provide accurate 3-D representations and detailed information regarding geometry of stems and internal defects, especially of knots. Knots are the main cause for sawn timber down-grading particularly due to their effect on warping, mechanical properties and aesthetics. For Maritime pine, Machado [12] reports that knots count

* Correspondence and reprints
Tel.: +358 9 456 5565; fax: +358 9 456 7027; e-mail: isabel.pinto@vtt.fi
© INRA, EDP Sciences, 2003

Table I. Characteristics of the plot (279th plot from Leiria Forest) and of the 20 sample maritime pine trees (mean and standard deviation).

Plot characteristics		Characteristics of the sample trees		
			Mean	SD
Site index ⁽¹⁾	DH (50)> 20 m	Total height (m)	28.8	2.8
Age	83 years	Crown height ⁽⁶⁾ (m)	8.7	2.6
Basal area	25.1 m ² ha ⁻¹	Height to first dry branch (m) ⁽⁷⁾	16.0	2.1
Density	171 trees ha ⁻¹	DBH (cm)	47.8	7.3
DH ⁽²⁾	23.6 m	Bark thickness at DBH	3.4	0.7
DDBH ⁽³⁾	47 cm	Volume over bark (m ³) ⁽⁸⁾	2.7	0.7
Regeneration	seedling	Volume under bark (m ³) ⁽⁸⁾	2.3	0.6
Thinning ⁽⁴⁾	low thinning			
Pruning ⁽⁵⁾	up to height of 2 m			

(1) Dominant height (DH) at 50 years; (2) dominant height; (3) dominant diameter at breast height; (4) first thinning at 15 yr, last at 58 yr, mostly with a 5 yr period; (5) pruning till 2 m high maximum till 15 yr; (6) crown height = total height - live crown base height; crown base at the simultaneous occurrence of 2 green branches; (7) height from tree base to the first visible dry branch; (8) precise cubic method, Smalian formula.

50% of the rejections in the grading for structural uses and for 44% of downgrading in visual strength grades. Characteristics of internal knots such as knot quality, length and diameter distributions, decisively contribute to the value yield from log sawing.

Studies on knottiness have been carried out recently by several authors for Scots pine (*Pinus sylvestris* L.) and Norway spruce (*Picea abies* (L.) Karst.) using different techniques: direct measurements of the knot parameters in whorls [19, 29, 30], peeling methods to produce veneer strips, further measured with an electronic device [11], CT-scanning technologies [1, 2, 13, 17] and inventory data and predicting models [3, 4, 7, 14–16]. For Maritime pine (*Pinus pinaster* Ait.) knottiness has been studied through crown architecture and external branch measurements but very few data have been published [8, 9, 18, 26]. Neither are data available in the literature for this species concerning the internal knots properties and log modelling based in new scan technologies.

This paper presents the application of a 3D-computer-aided stem and log reconstruction software, based on input information obtained by image scanning, to twenty 83 years old Maritime pines. The stem/log reconstruction is a software module designed to serve as input data for sawing simulation within WoodCim[®], an integrated optimising software system developed by the VTT Technical Research Centre of Finland for Scots pine and Norway spruce and comprising several modules to model the whole conversion chain from forest to end products [27, 28]. The procedures used for converting real logs, and their internal knots, into virtual representations are described. The results obtained with this reconstruction are the shape of log/stem and knot parameters such as length diameter and volume which will be used to analyse the variation of the internal knottiness within the 20 Maritime pine stems.

2. MATERIALS AND METHODS

2.1. Tree sampling

Twenty Maritime pine (*Pinus pinaster* Ait.) trees were randomly sampled from a stand in Portugal, the Leiria pine forest. This forest is

situated in central coastal Portugal (39° 45' 00 N, 8° 55' 60 W WGS 84, 113 m a.s.l.), under strong Atlantic influence with constant North and Northwest winds. Mean air temperature varies between 12.5 °C and 15 °C, relative air humidity between 80 and 85% and yearly rainfall values are usually between 700 mm and 800 mm [5]. The trees were sampled from an 83-year-old even-aged plot. *Table I* shows the main plot characteristics as well as the biometric data for the sampled trees [10, 20].

After harvesting, total height, crown height and height of the first visible dry branch were measured for each tree. The base of the living crown was located between 60% and 80% of total tree height and the first visible dry branch was located in 70% of the trees between 45% and 60% of total tree height and the remaining above this level. Two cross diameters (N-S, W-E) were measured every 2.5 m along the tree and bark thickness was determined with a bark gauge in the position of largest thickness. Detailed information about the sampled trees can be found at Pinto [20].

2.2. Mathematical reconstruction of logs and stems

Each tree was crosscut into 4 logs, each 5-m long (*figure 1a*). In the cross sections of each log, a line was drawn in the North-South direction through the pith. The logs were sawn into 25-mm thick flitches with the North-South line perpendicular to the saw blade. Each flitch/slab was marked with a code to identify its position in the log, in the tree and the North and South sawing surfaces.

The flitches were scanned in VTT using the WoodCim[®] inspector scanning system providing RGB (colour component) information stored in the computer files (24 bit bmp format) for further processing and analyses (*figure 1b*). The scanned images were computed by VTT's PuuPilot software. With assistance by the operator and with the image of the flitch on the screen, the system registered the geometrical outline of the sawing surface, the log pith line and the location, size, shape and quality factor of each knot (*figure 1c*). Knots were registered in the sawed flitch surface as well as in the edge and slab surfaces (surface knots). Each measurement was registered in data files as xy co-ordinates. The slab thickness measured during scanning was also introduced in the slab data file [24].

The data concerning the geometric and knot features of the individual flitch files pertaining to one log were processed with the WoodCim[®] module software for the mathematical reconstruction of a log in a 3D system. The North-South line drawn on the top of logs before sawing was used as a reference line to join the flitches in their correct position and to create the z-coordinate (*figure 1d*). The stem was reconstructed by joining the different logs of a tree.

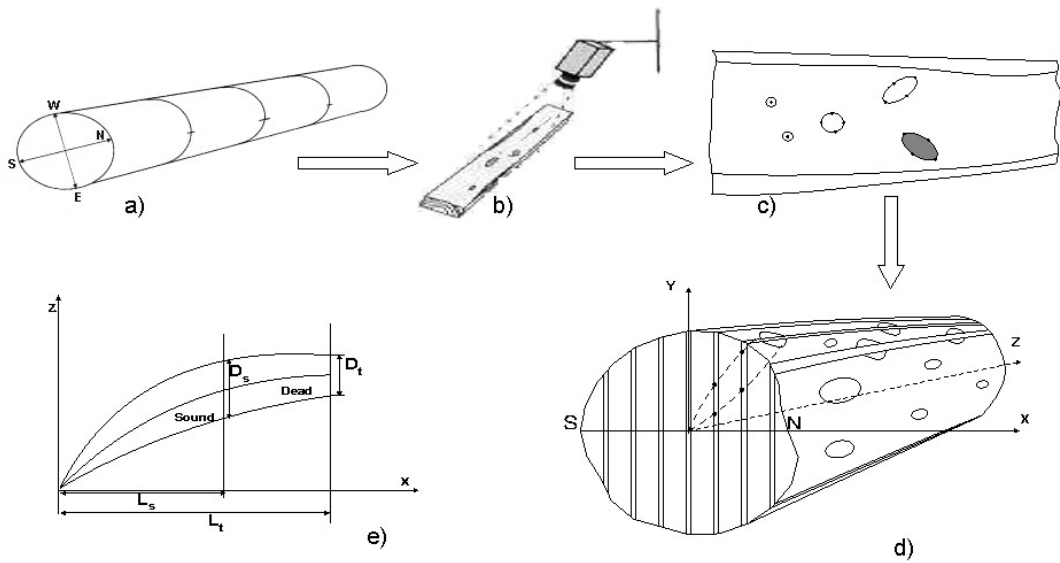

Figure 1. Log shape and internal knots reconstruction. (a) stem cross cutting into logs; (b) scanning of flitches; (c) marking knots on the flitch sawing surface; (d) log and knots reconstruction in the xyz co-ordinate system; (e) knot in the xz plane, total (D_t) and sound (D_s) knot diameter, total (L_t) and sound (L_s) knot length. (adapted from Song [24]).

With all flitches and slabs of a log assembled in the xyz co-ordinate system, the reconstructed log geometry was described with a series of cross-sections, each defined with 24 vectors calculated between the pith line points and the outline points of flitches and slabs. The saw kerf thickness used in the sawing of the logs was introduced between each two flitches [24]. Log taper was calculated using the geometric co-ordinates from the reconstructed log as the slope of the external line obtained from a mean radius calculated each 50-mm along all length. The radius is the average of all vectors that define each cross-section. Log reconstructed diameters were calculated as the double value of the average radius.

The 3D reconstruction of knots was based on the xyz co-ordinates of the knot points that were registered in the sawed surface of each flitch (figure 1d). These data allowed the calculation of individual knot parameters such as co-ordinates of knot origin on the log pith, knot orientation angle in the log cross section, knot length, quality zones (sound, dry and rotten) and a set of data for knot pith line and diameters of a series of knot cross-sections [23, 24]. The scanned images of all the flitches of the 4 logs from one tree containing a total of 245 knots were analysed manually to determine the number of knots and their origin position in relation to tree height. These values were compared with the reconstruction output.

2.3. Analysis of individual knot parameters

The data from the reconstructed saw logs and tree stems were transferred to the Oksa2000 software, developed at VTT, that automatically processes the information on the knots included in the reconstructed model. The programme uses as input the geometrical and knot data and gives as output: stem/log volume, individual knot volume (total and sound) and relative amount of knots in the total log/stem volume, and, for each knot, compass angle in the stem/log cross-section, diameter (total and sound) and length (total and sound), as shown in figure 1e. Knot volume was calculated as a sum of volumes from sections computed every 20 mm of knot length. These outputs were used to study the variation of knot length, diameter and volume with tree height level, calculated in % of total tree height in intervals of 5% of tree height.

3. RESULTS

The results obtained with the computer-aided reconstruction of logs are exemplified in figure 2 where the reconstitution of two logs (one butt and one middle log) is represented as a 3D view and as a 2D projection on the transverse plane.

3.1. Log shape

Log shape and taper are directly visualised in the reconstruction images and differences between logs may be qualitatively recognised, i.e. the butt swell and larger taper as shown in figure 2a.

The diameters obtained with the reconstructed model followed very closely the actual diameters of the logs measured in the field. The difference between modelled and field measured diameters was below 1% of the measured values except for the 20 m level where the modelled diameter was 4% higher than the measured diameter.

The top diameter for the 80 reconstructed logs varied from 15 cm to 52 cm, with 56% of the logs showing top diameters between 25 and 35 cm. Top diameters decreased with log position in the tree from an average 36 cm for butt logs to 24 cm for top logs (figure 3). Taper was 9 mm/m on average, ranging between 4 and 22 mm/m. Butt and top logs have the highest taper values, respectively 13 and 11 mm/m, while middle logs have taper values of 6 and 7 mm/m (figure 4).

3.2. Knot dimensions

The representation of the internal distribution of knots as reconstructed by WoodCim[®] allows to visualize their location along the log and radial extension, i.e. showing differences between logs in relation to proportion of knot-free wood (figure 2).

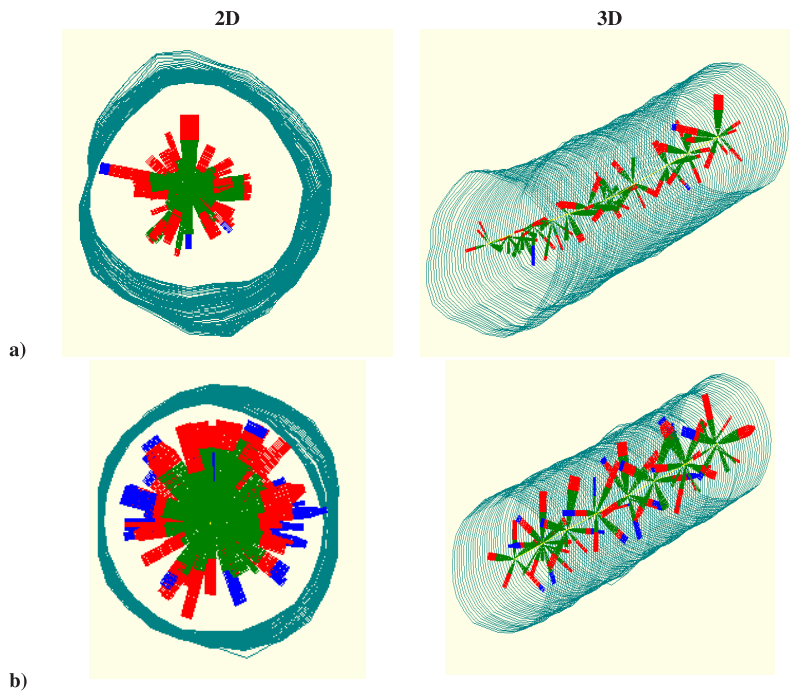

Figure 2. Mathematically reconstructed logs of maritime pine showing the geometry of the log and the internal knots in 2 and 3 dimensions. (a) butt log; (b) middle log.

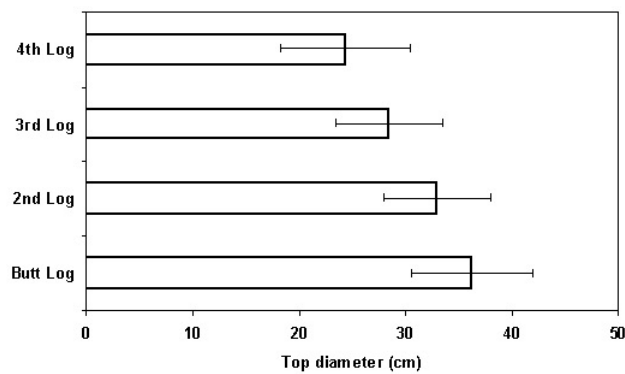

Figure 3. Top diameter for different log positions in the stem. Average and standard deviation (bar) of 20 logs.

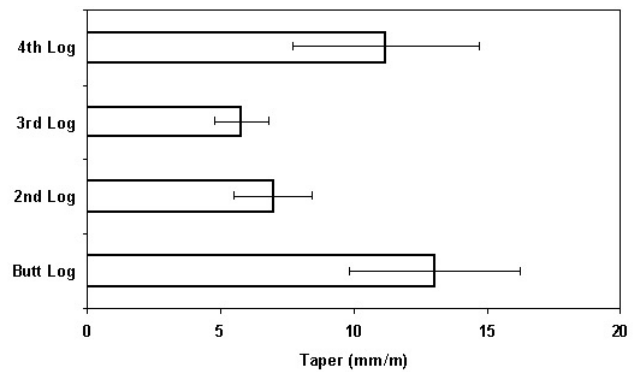

Figure 4. Log taper for different log positions in the stem. Average and standard deviation (bar) of 20 logs.

The accuracy of reconstruction in relation to number and position of knots was tested in 4 logs of one stem by comparing the model outputs with the direct measurements (table II). The number of reconstructed knots in each log differed from the reality only by 2 and the calculated positions for the knot origin on the log pith (Z co-ordinate of the origin point of knot pith) showed a mean deviation of 7.8 mm.

The proportion of total knot volume and sound knot volume in the total log volume as well as its variation with log position in the tree is shown in figure 5. The proportion of knots increases significantly from butt to top logs corresponding to 0.07 and 1.95% of log volume, respectively. The proportion of sound knots followed the same trend. The ratio of sound knots in the total knot volume is higher in butt and top logs than in middle

logs, the highest proportion of dead knots being found in the 3rd log (38%).

Figure 6 shows the variation of the total and sound knot core with tree height. The proportion of the tree cross section covered by the knot core increases strongly within the tree from stem base to the top: the total knot core represents 28% of the tree radius in the stem butt, and 84% at the stem top. The sound knot core shows the same type of variation, but the increase rate with tree height is slower when compared with total knot core. The variation is linear up to 50% of total tree height, the slope being higher for the total knot core. In the upper part of the stem, from 55% of total tree height upwards, the proportion of the knot core remains approximately constant at 85% and 65% of the tree diameter, respectively for the total and sound knot core.

Table II. Comparison of results given by the reconstruction of logs using WoodCim® and reality in relation to the number of knots and the Z coordinate of knot origin (height in the stem) as mean of deviations (real-reconstructed, in mm) and standard deviation, determined for the 4 logs of one stem.

Log position	Number of knots		Deviations of Z coordinate (mm)	
	Real	Reconstructed	Mean of deviations	SD
1st	56	54	5.4	4.4
2nd	41	39	6.6	6.0
3rd	76	78	9.8	9.2
4th	72	70	8.3	11.9
Stem	245	241	7.8	9.0

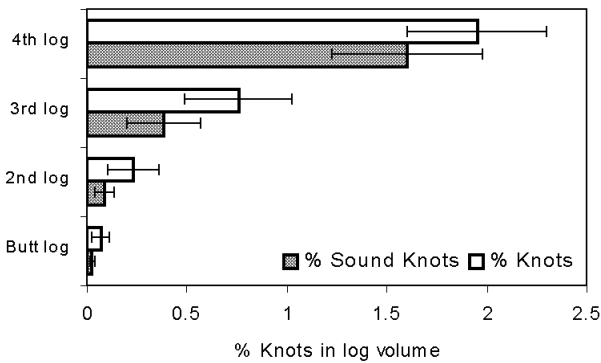

Figure 5. Proportion of the total knot volume and sound knots volume in the total log volume for different positions in the tree. Average and standard deviation (bar) of 20 reconstructed logs.

The variation of knot diameter, length and volume with tree height is presented in *figure 7*. Knot dimensions increase with tree height up to about 60% and after this level tend to stabilise or slightly decrease. Total knot length (L_t) increases from 5.7 cm at stem base to 12.4 cm at 55% of total tree height, decreasing then to the top. Sound knot length increases slowly in the lower part of the stem but faster after 40% of total tree height, reaching a maximum value of 9.5 cm at 60%. After that level it decreases slightly and at 80% of total tree height the sound knot length is close to the total knot length at this level (7.6 cm and 8.7 cm, respectively).

Total knot diameter (D_t) and sound knot diameter (D_s) increase almost linearly upwards up to 60% of total tree height where the maximum values are attained (3.2 and 3.6 cm, respectively). Between 60 and 80% of total tree height, D_t and D_s stabilise and the curves become close with only a 0.1 cm difference at 80% of total tree height.

The within tree variation of knot volume reflects the variation of knot length and diameter. Total (V_t) and sound (V_s) volumes increase very fast until 60% of total tree height (respectively 108 and 87 cm³) followed by a decrease to the top of the stem. The variation of knot volume, length and diameter with tree height could be mathematically described with polynomial functions that were fitted to the data with high correlation factors and statistical significance (*table III*).

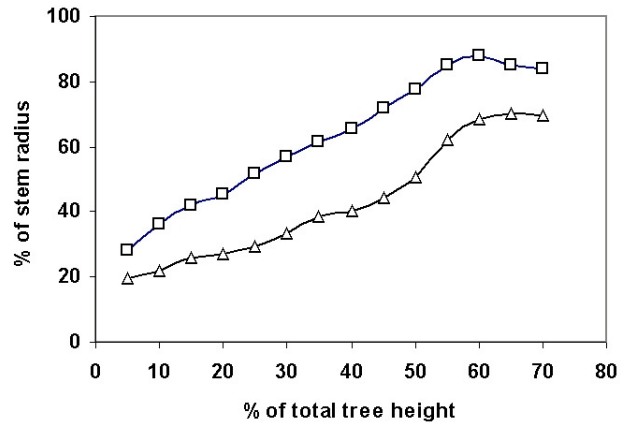

Figure 6. Total (□) and sound (Δ) knot core in percent of the stem radius. Average for the 20 trees.

4. DISCUSSION

The reconstruction model and knot calculation software (WoodCim® and Oksa2000, respectively) allowed a clear visualisation of important quality features of Maritime pine stems and their subsequent quantification, e.g. log geometry and knot parameters.

The reconstruction provided a good description for log shape with only small deviations between simulated and measured diameters (*table II*). The somewhat higher differences found for top logs result from the more irregular shape of stem at this level, already located in the dead crown area (i.e. the first dry branch was on average at 16 m of height) and with larger surface knots.

Concerning knots, the reconstruction was tested in relation to number of knots and location of knot origin on the stem pith on a sub-sample (total of 245 knots) and both results were good showing only minor differences between simulation and measurement (*table II*). Further analysis on larger samples is however required for a full validation of the accuracy of the reconstruction model. In fact, few results on large scale testing of reconstruction models, especially concerning the modelling of individual knots, have been published and most refer to small sample sizes or to comparison of measurement methodologies [17, 23].

In the present study the reconstruction of logs and stems allowed to obtain useful information to characterise the quality of the Maritime pine stems that were analysed. At this stage and with the limited number of trees studied, the information cannot be regarded as representing the diversity occurring for the species (i.e. of provenance, growth and management conditions). The trees studied here are probably to be included in the best quality assortments available in Portugal for the saw-milling supply. In fact, the state-owned Leiria forest where the trees were sampled is known as a good site for pine growth with a management oriented for high added value timber products, including 5 years rotation thinnings between 20 and 40 years of tree age, pruning before the first thinning and clear cutting at an approximate age of 80 years [5]. In most of the private-owned pine stands, the rotation is about

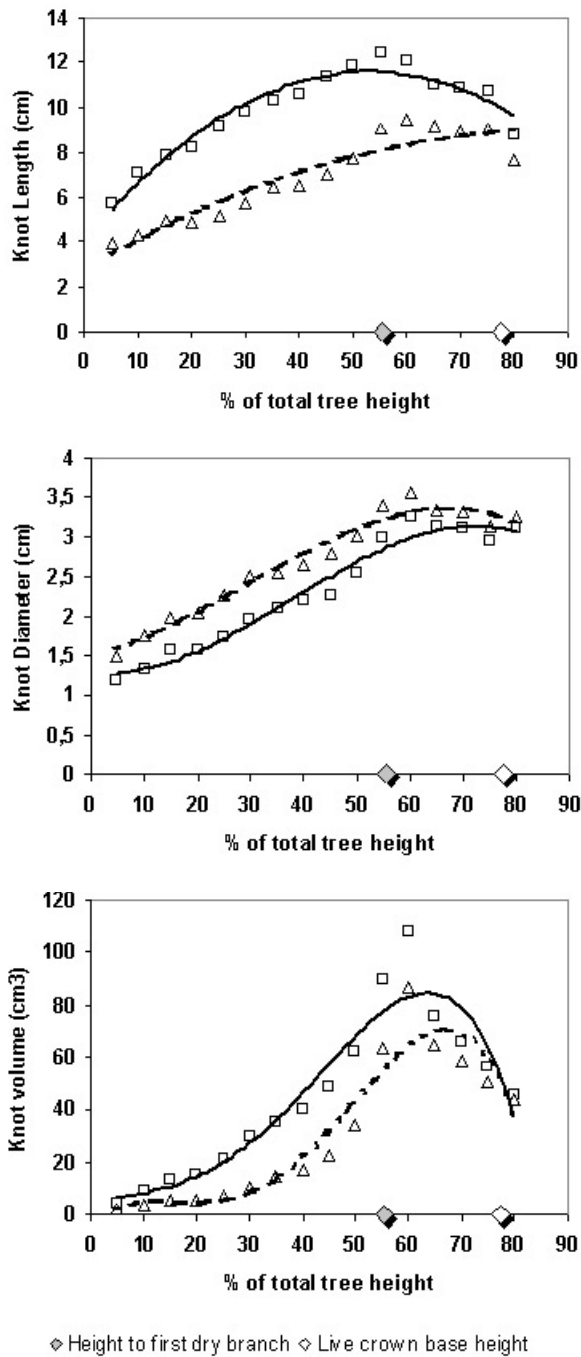

Figure 7. Total (\square) and sound (Δ) knot length, diameter and volume as a function of tree height, as the average for the 20 sampled trees. The corresponding polynomial fitted curves are indicated by (-) for total knot dimensions and by (--) for sound knot dimensions.

40 years, the forest is not managed and has no cultural operations [20]. A study made on the characterisation of Maritime pine logs in sawmills in different regions showed an average log diameter of only about 25 cm [21]. This is clearly below the average log diameter found here and corresponds to the diameters of top logs of the sampled trees (figure 3).

One important output parameter from the reconstruction of logs and stem refers to tree form, which is directly connected with log value, harvesting and processing costs and sawing yields. During conversion, log taper and diameter significantly impact on lumber yield and grade and on the size of the lumber to be produced [31].

The taper variation could be followed along the stem of the sampled Maritime pine trees (figure 4). For most logs taper is within the 6–11 mm/m values reported for Maritime pine logs [21] and butt-swell could be observed in the reconstruction output (figure 2). The middle logs presented the lowest taper values (figure 4), an indication of their potential to produce long structural lumber, when compared with butt and top logs. The taper increases in the top log resulting from the fact that at this height level (15–20 m) it is included in the dead crown zone. Maritime pine has a weak natural pruning and the death crown depth (often with big branches) is an important cause for depreciation of top logs [25].

The internal architecture of knots is clearly visible in the reconstruction images (figure 2). Since the outputs have different colours for sound and dead knots, an appraisal of knot quality distribution is directly appreciated which is not possible here in the black and white image.

The volume proportion of knots showed a strong increase with stem height (figure 5). The knot core also increased with tree height and remained rather constant in the upper part of the commercial stem (figure 6), corresponding approximately to the top log included in the dead crown (the first visible dry branch was located on average at 55% of total tree height). In the lower part of the stem, the knot core was small (on average 24% of the stem radius) and had the lowest proportion of dead knots. This stresses the importance of pruning Maritime pines at early stages since the tree has well branched first crown whorls and a weak natural pruning as referred above [25].

The within tree variation of knot dimensions could be followed, in average, up to 80% of total tree height, which represents the commercial section of the stem and therefore the most important in terms of value yield for timber products. Knot length and diameter increased along the stem attaining maximum values at approximately 60% of total tree height. The dimensional increase rate was higher in the 50–60% of total tree height, especially for diameter and volume (figure 7), probably a response to the thinnings that occurred when tree height corresponded approximately to the levels of 54 to 63% of the final total tree height. According to studies on mean annual height increments for this species [18], the thinnings were made when height increments were already in the decreasing phase allowing the tree to invest more in crown and diameter growth.

Knot dimensions have been related to tree diameter class in Scots pine [13, 14] and spruce [29]. This was also tested here, allowance made for the limited sampling and the fact that the stem within the living crown was not investigated. For the studied Maritime pines, the tree average knot total diameter and diameter at breast height showed a highly significant correlation ($r = 0.64$, $P = 0.0023$). Above the live crown level, knot size decreases with tree height according with previous studies [8].

Table III. Curve fitting to the variation of total and sound length (cm), diameter (cm) and volume (cm³) with percentage of total tree height (H).

Equation	R ²	F	P-value
Knot Length			
$L_t = -0.0026H^2 + 0.2809H + 4.1313$	0.94	97.67	< 0.001
$L_s = -0.008H^2 + 0.1386H + 2.7745$	0.88	51.66	< 0.001
Knot Diameter			
$D_t = -1 \times 10^{-0.5} H^3 + 0.0013H^2 - 0.009H + 1.3014$	0.97	126.55	< 0.001
$D_s = -9 \times 10^{-6} H^3 + 0.0008H^2 + 0.0154H + 1.4951$	0.97	110.16	< 0.001
Knot Volume			
$V_t = -2 \times 10^{-5} H^4 + 0.0018H^3 + 0.0318H^2 + 0.5652H + 4.1683$	0.90	25.57	< 0.001
$V_s = -3 \times 10^{-5} H^4 + 0.0038H^3 - 0.138H^2 + 1.8758H - 3.9705$	0.90	25.60	< 0.001

In summary, the reconstruction of the maritime pine stems based on visual scanning as made in this study allowed to obtain knowledge about stem shape and internal knot distribution as well as on their variation within the tree, that was not available before. Although not representative for the diversity of provenance and growth conditions of the species, the data given here are among the first published for *Pinus pinaster* Ait. Further studies and an increased sampling will allow the gathering of more comprehensive information to be used as a tool for optimising the industrial processing, i.e. to better select logs within the stem for different final uses and as data input for yield analysis through sawing simulation.

5. CONCLUSIONS

The use of visual scanning techniques and computer-aided reconstruction was applied for Maritime pines and 3D and 2D representations were obtained for logs and trees allowing the visual appraisal of external shape as well as of the internal knot architecture. Information on tree geometry and knot parameters could be obtained from the reconstructed logs and stems. These data, although not representative for the diversity of Maritime pine in Portugal, are among the first to be published for the species.

Acknowledgments: Financial support was given to the first author by a scholarship from Fundação para a Ciência e Tecnologia (Portugal) and by a Marie Curie Research Training Grant within the EU 4th RTD Framework programme. The work was carried out under the research programme PAMAF 8185, financed by INIA (Instituto Nacional de Investigação Agrária, Portugal). Thanks are due to the Portuguese National Forest Service (Direcção Regional Agrária da Beira Litoral) who supplied the trees and their silvicultural records.

REFERENCES

- [1] Björklund L., The interior knot structure of *Pinus sylvestris* stems, Scand. J. For. Res. 12 (1997) 403–412.
- [2] Björklund L., Pettersson H., Predicting knot diameter of *Pinus sylvestris* in Sweden, Scand. J. For. Res. 14 (1999) 376–384.
- [3] Colin F., Houllier F., Branchiness of Norway spruce in northeastern France: modelling vertical trends in maximum nodal size, Ann. Sci. For. 48 (1991) 679–693.
- [4] Colin F., Houllier F., Branchiness of Norway spruce in northeastern France: predicting the main crown characteristics from usual tree measurements, Ann. Sci. For. 49 (1992) 511–538.
- [5] Gomes S., Leiria National Forest – More than a hundred years producing quality timber, in: Proceedings of COST E10 2nd Workshop – Wood properties for industrial use. Ed. EFN, Mafra (1999) 90–91.
- [6] Grundberg S., An X-ray LogScanner - a tool for control of the sawmill process. Division of Wood Technology, Luleå University of Technology, Doctoral thesis, Skellefteå, 1999, 29 p.
- [7] Houllier F., Leban J.-M., Colin F., Linking growth modelling to timber quality assessment for Norway spruce, For. Ecol. Manage. 74 (1995) 91–102.
- [8] INRA, Upgrading of Southern European pines. Final report, Project MA2B-CT91-0040, INRA Bordeaux, Arbez M. (Ed.), 1994.
- [9] INRA, Modèle de croissance et qualité pour le Pin maritime (tranche 1). Second rapport d'avancement des travaux, Colin F. (Ed.), 2000, 25 p.
- [10] Instituto Florestal, Mata nacional de Leiria, Revisão do ordenamento. Ed. DGF, Marinha Grande, 1990, 150 p.
- [11] Lemieux H., Samson M., Usenius A., Shape and distribution of knots in a sample of *Picea abies* logs, Scand. J. For. Res. 12 (1997) 50–56.
- [12] Machado J.S., Avaliação da variação das propriedades mecânicas de pinho bravo (*Pinus pinaster* Ait.) por meio de ultra-sons. Doctoral thesis. Instituto Superior de Agronomia, Universidade Técnica de Lisboa, 2000, 221 p.
- [13] Moberg L., Models of knot properties for Norway spruce and Scots pine. Doctoral thesis. Dept. of Forest Management and Products, Swed. Univ. of Agri. Sciences, Uppsala, 1999, 24 p.
- [14] Mäkinen H., Colin F., Predicting branch angle and branch diameter of Scots pine from usual tree measurements and stand structural information, Can. J. For. Res. 28 (1998) 1686–1696.
- [15] Mäkinen H., Colin F., Predicting the number, death, and self-pruning of branches in Scots pine, Can. J. For. Res. 29 (1999) 1225–1236.
- [16] Märkelä A., Vanninen P., Ikonen V., An application of process-based modelling to the development of branchiness in scots pine, Silva Fennica 3 (1989) 287–299.
- [17] Oja J., Measuring knots and resin pockets in CT-images of Norway spruce. Division of Wood Technology, University of Technology, Luleå, Licenciante thesis, Skellefteå, 1997, 6 p.
- [18] Paulo M.J., Tavares M., Policiclismo do crescimento do pinheiro bravo das dunas do litoral português, Silva Lusitana 4 (1996) 25–38.

- [19] Pietilä J., Shape of Scots pine knots close to the stem pith, *Silva Fennica* 4 (1989) 287–299.
- [20] Pinto I., Modelling of wood conversion chain for *Pinus pinaster* Ait. Masters degree thesis. Instituto Superior de Agronomia, Universidade Técnica de Lisboa, 1998, 83 p.
- [21] Reimão D., Tavares M., Carvalho A., Leitão, M., Palma A., Base-line da indústria de serração de madeiras resinosas em Portugal, in: *Actas do III Congresso Florestal Nacional, Os recursos florestais no desenvolvimento rural*, Ed. SPCF Lisboa (1994) 207–231.
- [22] Saint-André L., Modélisation tridimensionnelle des profils de largeur de cerne dans un billon d'épicéa (*Picea abies* Karst) compte tenu de la mesure de son enveloppe externe et des caractéristiques dendrométriques usuelles de l'arbre d'origine. Thèse de Doctorat de l'ÉNGREF. Publication Équipe de Recherches sur la Qualité des Bois, 1998, 215 p.
- [23] Samson M., Modelling of knots in logs, *Wood Sci. Technol.* 27 (1993) 429–437.
- [24] Song T., Tree stem construction model for “Improved spruce timber utilisation” project. VTT Building Technology internal report. Helsinki, 1998, 20 p.
- [25] Tavares M., Maritime pine wood quality in Portugal, a few reasons responsible for some of its characteristics and defects, in: *Proceedings of COST E10 2nd Workshop – Wood properties for industrial use*. Ed. EFN, Mafra (1999) 81–87.
- [26] Tavares M., Campos J., Optimisation of biometric data collecting on video images of breaked up trees, using PhotoModeler and AutoCAD software, in: *Proceedings of COST E10 3rd Workshop – Measuring of wood properties, grades and qualities in the conversion chains and global wood chain optimisation*. Ed. Usenius, VTT Espoo (2000).
- [27] Usenius A., Optimizing models for predicting value yield in sawmilling industry, in *Proceedings of Seminar/workshop on Scanning Technology and Image Processing on Wood*. Skellefteå, Sweden. University of Luleå, 1992, 11 p.
- [28] Usenius A., Optimizing the activities in the wood conversion chain from forest to the end-users, in: *Proceedings of Second workshop in “Connection between Silviculture and wood quality through modelling approaches and simulation softwares”*. Kruger National Park, Npveu (Ed.), INRA Nancy, 1996, pp. 214–219.
- [29] Vestøl G.I., Colin F., Loubère M., Influence of progeny and initial stand density on the relationship between diameter at breast height and knot diameter of *Picea abies*, *Scand. J. For. Res.* 14 (1999) 470–480.
- [30] Vestøl G.I., Høibø O.A., Internal distribution of sound and dead knots in *Picea abies* (L.) Karst, *Holz als Roh- und Werkstoff* 58 (2000) 107–114.
- [31] Zhang S.Y., Wood quality: its definition, impact and implications for value-added timber management and end-uses. CTIA/IUFRO International wood quality workshop - Timber management toward wood quality and end-product value. Quebec city, 1997, pp. 117–139.

ORIGINAL ARTICLE

Isabel Pinto · Helena Pereira · Arto Usenius

Heartwood and sapwood development within maritime pine (*Pinus pinaster* Ait.) stems

Received: 22 July 2003 / Accepted: 29 October 2003 / Published online: 29 November 2003
© Springer-Verlag 2003

Abstract Heartwood and sapwood development in maritime pine (*Pinus pinaster* Ait.) is reported based on 35 trees randomly sampled in four sites in Portugal. It was possible to model the number of heartwood rings with cambial age. The heartwood initiation age was estimated to be 13 years and the rate of sapwood transformation into heartwood was 0.5 and 0.7 rings year⁻¹ for ages below and above 55 years, respectively. Reconstruction of heartwood volume inside the tree stem was made by visual identification by image analysis in longitudinal boards along the sawn surfaces. This volume was integrated into the 3D models of logs and stems developed for this species representing the external shape and internal knots. Heartwood either follows the stem profile or shows a maximum value at 3.8 m in height, on average, while sapwood width is greater at the stem base and after 3 m remains almost constant up the stem. Up to 50% of tree height heartwood represents 17% of stem volume, in 83-year-old trees and 12–13% in 42 to 55-year-old trees. Tree variables such as stem diameter, DBH and tree total height were found to correlate significantly with the heartwood content.

Keywords *Pinus pinaster* Ait. · Maritime pine · Heartwood · Sapwood · Growth rings

Introduction

The xylem of most tree species contains two histologically similar but physiologically different zones: the sapwood and the heartwood. The sapwood, the outer zone, contains physiologically active living cells and

reserve materials. The outer rings allow the transport of water and minerals from the roots to the cambium and leaves.

The heartwood, the inner zone of the xylem, is physiologically inactive regarding water conduction. With tree ageing, the parenchyma cells die, lose their reserve material and the wood becomes impregnated with complex organic compounds. These are normally referred to as extractives and are responsible for the natural durability of this xylem zone and for its usually darker colour.

The mechanisms underlying these changes and the physiological functions of heartwood are not yet well known. It has been suggested that heartwood formation serves to regulate the amount of sapwood to a physiological optimum level (Bamber 1976), following the “pipe-model” theory relating sapwood area to foliage mass (Shinozaki et al. 1964). The amounts of heartwood and sapwood should therefore be related to all factors and conditions that affect crown size and vitality (Mörling and Valinger 1999; Bergstrom 2000). Other studies support that, after a certain initiation phase, heartwood is formed at a constant annual ring rate. Consequently, heartwood would be related to the cambial age and to the factors that impact growth rates, mainly in early stages (Hazenberg and Yang 1991; Wilkes 1991; Climent et al. 1993, 2002; Sellin 1994; Bjorklung 1999; Gjerdrum 2002).

Heartwood and sapwood contents vary between and within species and have been related to growth rates, stand and individual tree biometric features, site conditions and genetic control. Reviews on heartwood and sapwood formation and variation can be found in Bamber and Fukazawa (1985), Hillis (1987) and Taylor et al. (2002).

Heartwood and sapwood have different properties and their proportion within the tree will have a significant impact on the utilisation of wood. For pulping, heartwood is at a disadvantage as its extractives can affect the process and product properties. For solid wood applications the different properties of heartwood and sapwood influence drying, durability, and aesthetic values for the consumer (panels and furniture). When there is a large

I. Pinto (✉) · A. Usenius
VTT Building and Transport, P.O. Box 1806, 02044, VTT, Finland
e-mail: isabel.pinto@vtt.fi
Tel.: +358-9-4565565
Fax: +358-9-4567027

H. Pereira
Centro de Estudos Florestais, Instituto Superior de Agronomia,
1349-017 Lisbon, Portugal

colour difference between sapwood and heartwood, selection of wood components by colour also plays a significant role in some timber applications. This is the case for maritime pine (*Pinus pinaster* Ait.) where heartwood shows a strong reddish colour.

Maritime pine spreads naturally in Atlantic-influenced regions of Portugal, Spain and France (subspecies *atlantica*) and in the Mediterranean regions of France (including Corsica), Spain and Italy (including Sardinia and Sicily) (subspecies *pinaster*). In recent decades this species has been introduced with success into South Africa, New Zealand and Australia. In southern Europe it occupies approximately 4 million ha and in Portugal it is the most important species accounting for about 30% of the total forest area.

Maritime pine wood has pale yellow sapwood and reddish-brown heartwood. The heartwood is distinct with clearly defined growth rings and is naturally durable (Carvalho 1997; Cruz and Machado 1998). Very few studies have been presented in the literature concerning heartwood and sapwood development in this species. In 75-year-old maritime pine trees, heartwood represented 44% of the diameter at breast height and contained three times more extractives than sapwood (Esteves 2000). Stokes and Berthier (2000) and Berthier et al. (2001) studied the heartwood irregularity in relation to reaction wood in lean trees and found more heartwood rings on the leaning side of the tree, while Ezquerro and Gil (2001) reported on heartwood anatomy and stress distribution in the stem.

This paper aims to study the heartwood and sapwood formation and development in maritime pine, using ring analysis and a three-dimensional reconstruction algorithm

of heartwood that was added to the virtual stem representation already developed for this species (Pinto et al. 2003). The virtual stems thus obtained allowed us to study the cross-sectional and axial development of heartwood and sapwood within the tree.

Materials and methods

The study was based on 35 maritime pine (*Pinus pinaster* Ait.) trees sampled from different sites in Portugal. Heartwood was identified visually by image analysis in longitudinal boards along the sawn surfaces. Reconstruction of heartwood volume inside a log/stem was made and integrated with the 3D models of logs and stems developed for this species representing the external shape and internal knots (Pinto et al. 2003). Growth ring widths were measured at different stem levels.

Sampling

Thirty-five maritime pine trees were sampled from four stands in Portugal, covering the species' area of distribution and different management types: 20 trees in Leiria (S1), 5 trees in Mação (S2), 5 trees in Alpiarça (S3) and 5 trees in Marco de Canavezes (S4). The Leiria pine forest (S1) is state-owned with management oriented to produce high quality wood including pruning before the first thinning, 5-year rotation thinning between 20 and 40 years of age, and clear cutting at an age of approximately 80 (Gomes 1999). The other sites (S2–S4) are private-owned uneven aged stands, without cultural operations and trees are harvested within 40–50 years.

The trees were randomly sampled within each site. Total height, crown height and height of the first visible dry branch were measured for each tree. Two cross diameters (N-S, W-E) were measured every 2.5 m along the tree and the bark thickness was determined with a bark gauge at the point of greatest thickness. Table 1 shows the location and main geographic and climatic

Table 1 Site characterisation

Stand	S1	S2	S3	S4
Coordinates ^a	08°55'55"W, 39°45'02"N	07°59'49"W, 39°33'14"N	08°35'05"W, 39°15'36"N	08°08'55"W, 41°11'08"N
Altitude (m, a.s.l.)	88	278	25	216
Mean air temperature (°C)	12.5–15.0	15.0–16.0	16.0–17.5	12.5–15.0
Relative air humidity (%)	80–85	75–80	75–80	75–80
Annual rainfall (mm)	600–700	500–600	500–600	700–800
Total radiation (kcal/cm ²)	140–145	150–155	145–150	145–150

^a WGS84

Table 2 Biometric characteristics of the sampled maritime pine trees (mean and SD in parentheses) and site index

Stand	S1	S2	S3	S4
Site index ^a	DH (40)>17 m	DH (40)>14 m	DH (40)>18 m	DH (40)>21 m
Age	83 years	43–55 years	42–55 years	48–55 years
Number of sampled trees	20	5	5	5
Total height (m)	28.8 (2.8)	15.7 (3.4)	21.3 (1.0)	24.1 (1.0)
Crown height(m) ^b	8.7 (2.6)	7.7 (3.5)	9.1 (1.9)	10.0 (2.0)
Dead crown base (m) ^c	16.0 (2.1)	7.7 (1.2)	7.8 (1.3)	8.0 (1.6)
DBH (cm)	47.8 (7.3)	28.0 (2.3)	38.9 (9.2)	42.7 (5.3)
Volume over bark (m ³) ^d	2.7 (0.7)	0.5 (0.1)	1.3 (0.6)	1.6 (0.1)
Volume under bark (m ³)	2.3 (0.6)	0.4 (0.0)	0.9 (0.4)	1.2 (0.2)

^a Dominant height (DH) at 40 years (Tomé et al. 1998)

^b Crown height = total height—live crown base height; crown base at the simultaneous occurrence of two green branches

^c Height from tree base to the first visible dry branch

^d Precise cubic method, Smalian formula

Fig. 1 Schematic representation of a log cross-section showing the position of the flitches, sawkerf and vectors from the pith to the outline points of stem (a) and heartwood (b)

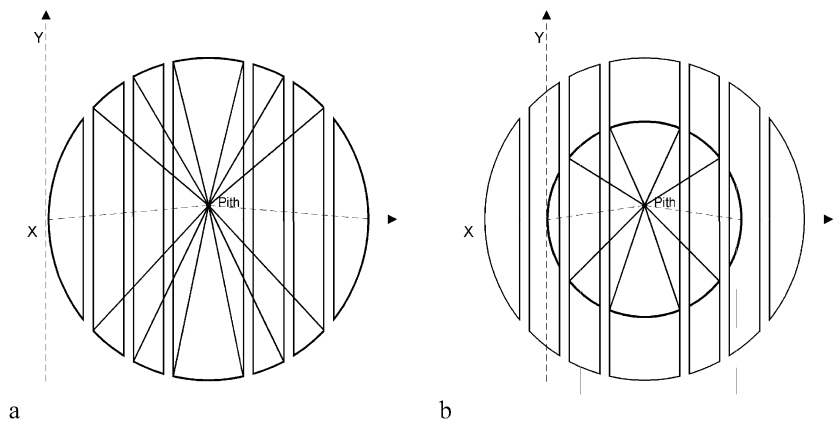

conditions of each site and Table 2 gives the biometric data for the sampled trees.

The trees were harvested, and bucked into 5 and 2.5 m logs, where the north-south orientation was marked. Wood discs (5 cm thick) were taken for growth ring analysis at the bottom end of each log and at the top end of the top log.

Mathematical reconstruction of logs and stems

The 35 sampled trees were transformed into a set of virtual stems by mathematical reconstruction based on the so-called flitch method as described in Pinto et al. (2003). The trees were cross cut into 2.5 and 5 m logs (total of 133 logs) which were live sawn into 25-mm thick flitches. The flitches were scanned using the WoodCIM camera system providing RGB (colour component) information and the scanned images were computed using VTT's PuuPilot software. On the image of the flitch and with assistance from the operator, the system registered in data files, as x , y -coordinates, the geometrical outline of the sawn surface, the log pith line and the location, size, shape and quality factor of each knot. The data concerning the geometrical and quality features of the flitch, together with its thickness and with the support of the north-south reference line to create the 3rd coordinate, were processed with a dedicated software producing a mathematical reconstruction in x , y , z -coordinate system of a log or of a stem by addition of the different logs from one tree (Usenius 1999). Cross-sections of the log/stem were described with a set of 24 radial vectors between pith and the flitches and slabs' outline points along the log length at 50 mm intervals (Song 1987, 1998).

Virtual reconstruction of the heartwood

In the scanned images of all flitches, the heartwood was singled out from the sapwood by colour difference and its external outline was marked for further computing by the PuuPilot software. The individual flitch files pertaining to one log, with the data concerning the geometric features of the heartwood, were processed with the WoodCim[®] module software with the same algorithms and methodology described above for the log/stem geometry. Therefore a 3D representation of the heartwood along the log was obtained. The heartwood in the stem was subsequently reconstructed by joining the different logs from the same tree.

The heartwood data were further integrated with the reconstructed logs' data (shape and knot internal structure) based on the common pith xyz points, thereby producing a new 3D reconstruction including the geometrical description of the outer shape of the log, the internal knot architecture and the shape of heartwood. Figure 1 shows the construction and integration of the stem and heartwood shape in a transverse section.

Heartwood and sapwood contents

Based on the virtual stems' descriptive files, the amount of sapwood and heartwood was computed for each 50 mm of stem height by using the following variables: stem, heartwood and sapwood diameter, area and volume and respective proportions in the stem.

The stem and heartwood diameter at a certain height level are the double value of the average of all radial vectors that define the cross-section at that level and were used to calculate stem and heartwood cross-sectional areas. The volume for each stem height section was calculated as a conical trunk by the Simpson formula:

$$\text{volume} = \left(\frac{\text{height}}{3} \right) \times \left(\text{area1} + \text{area2} + \sqrt{\text{area1} \times \text{area2}} \right) \quad (1)$$

The sapwood area and volume were calculated as the difference between the corresponding values for stem and heartwood.

Data validation

The validation of the heartwood and sapwood reconstruction was made by a comparison with calculations based on growth ring measurements made directly on the wood discs taken from each log. The wood discs were sanded and the growth rings within heartwood and sapwood were counted and measured on two radii (S1, E-W) or on eight radii (S2-S4, N-S, E-W, SW-SE, NW-NE).

The virtual stem diameters had been previously compared with field measured diameters (Pinto et al. 2003). The difference between modelled and field diameter values was below 1% of the measured values except for the 20 m level where the modelled diameter was 4% higher than the measured one.

Results

3D reconstructed models

The results obtained for the reconstruction of logs and stems including the heartwood are exemplified in Fig. 2 for one log showing the stepwise procedure as a 3D view and as a 2D projection on the transverse plane. The associated files include information on stem and heartwood geometry as well as on the quality and dimensions of each knot in cross-sections for each 50 mm of stem height.

The heartwood was present in all the logs with the exception of the six top logs where the amount of

Fig. 2 Mathematical reconstruction of one maritime pine log showing in two and three dimensions, the geometry of the log and the internal knot architecture (A), the heartwood and the internal knot architecture (B) and the full model with the integration of both

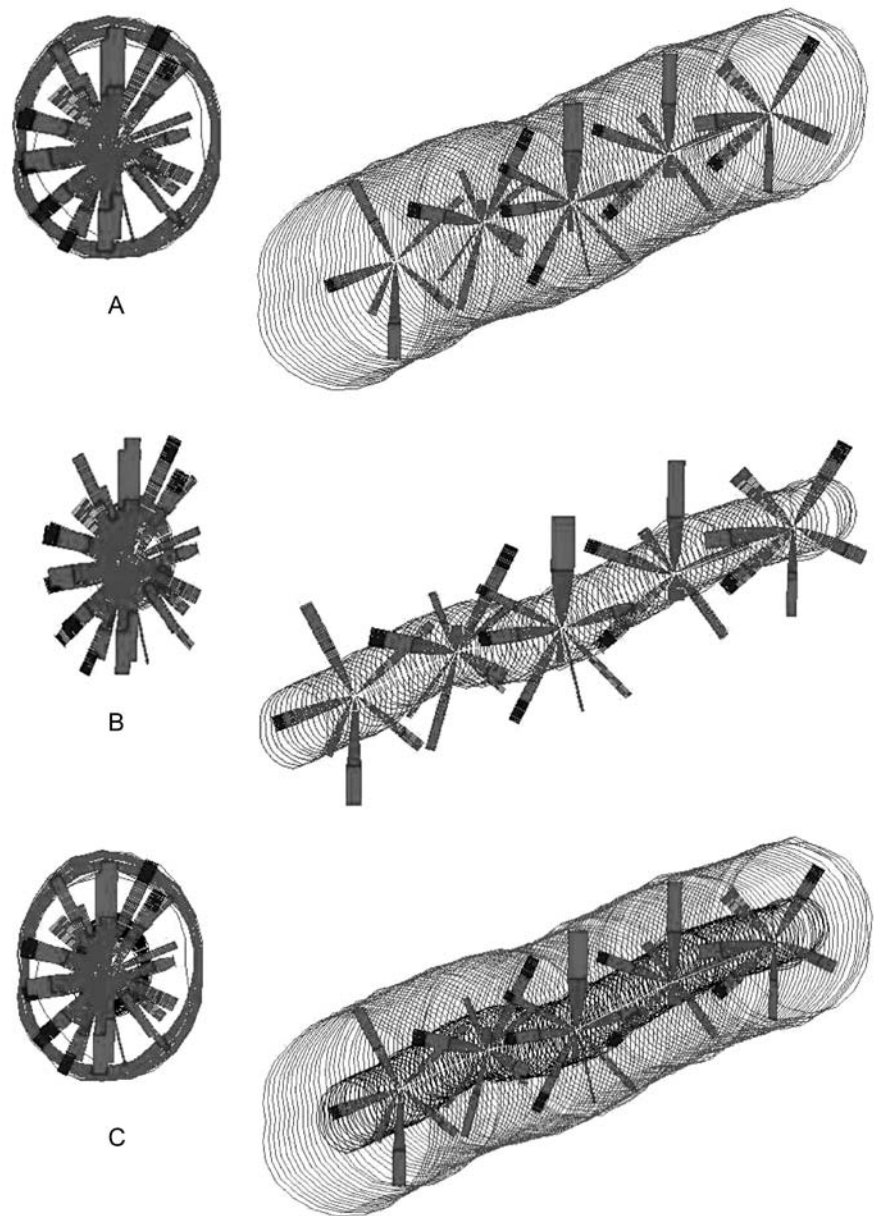

heartwood was too low to be used in the reconstruction algorithm.

The accuracy of the reconstructed heartwood diameters was calculated by comparison with measurements taken on the wood discs. On average, the modelled diameters were 4% below the measured ones, ranging from -12.9% to +8.4% at the different height levels. The correlation between modelled and measured diameters was highly significant ($P < 0.001$, $R^2 = 0.88$) and shows very few outliers (Fig. 3).

Variation of heartwood with age

The number of growth rings included in the heartwood increased with cambial age for all the trees and sample

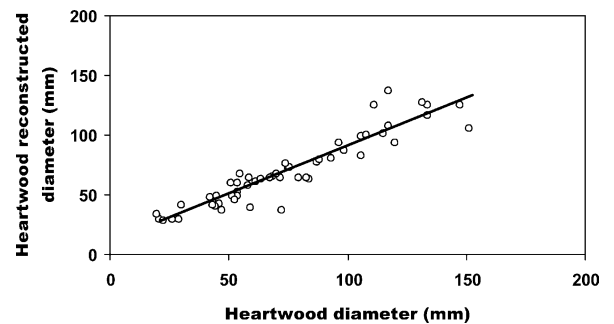

Fig. 3 Correlation of modelled heartwood diameters with diameters measured on the wood discs

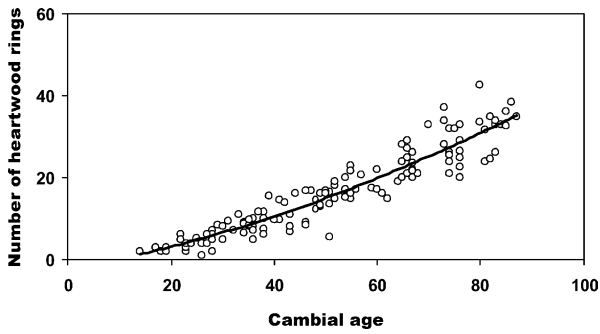

Fig. 4 Evolution of the number of heartwood rings with cambial age and fitted model ($H_{twr} = -2.400 + 0.231 \text{ age} + 0.002 \text{ age}^2$, H_{twr} number of heartwood rings, age cambial age at the same level)

Table 3 Average, minimum, maximum and standard deviation values for the heartwood annual formation rates for cambial ages over and above 55 years

	Average	Minimum	Maximum	SD
Number heartwood rings/year				
<55 years				
S1	0.50	0.34	0.72	0.11
S2	0.33	0.22	0.56	0.15
S3	0.51	0.32	0.80	0.18
S4	0.34	0.14	0.46	0.13
>55 years				
S1	0.70	0.21	1.75	0.46

sites (Fig. 4). A total of 138 samples were measured with cambial age between 14 and 87 years. Regression analysis indicated that a second degree polynomial best predicted the number of heartwood rings as a function of cambial age ($P < 0.001$, $R^2 = 0.89$) but a linear fitting also showed a good and high significance adjustment ($P < 0.001$, $R^2 = 0.88$). By extrapolation the heartwood initiation age was found to be 13 years with the second degree fitting, and 18 years with the linear fitting. In the samples studied, the first phases of heartwood formation (1–3 heartwood rings) were found in discs with cambial ages ranging from 13 to 28 years.

A regression analysis for different cambial age groups (below and above 55 years) indicated that heartwood forms, in average, at a higher rate for older ages (0.7 rings/year) than for younger ages (0.5 rings/year). However this rate was variable for individual trees within the studied sites (Table 3).

The variation of heartwood formation with age may also be followed by analysis of within tree variation, along the stem height, of the number of heartwood rings (Fig. 5). The number of heartwood rings decreased with tree height following the decrease in the total number of growth rings. However the proportion of heartwood rings slightly increased or remained constant in the lower part of the stem and decreased afterwards in the upper part of the stem, following the differences in cambial ages along stem height. The same difference was noticed between S1

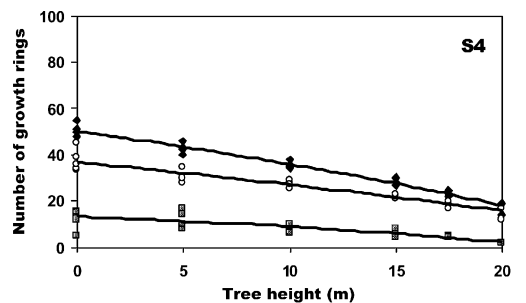
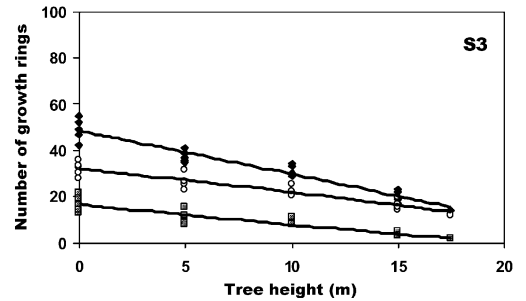
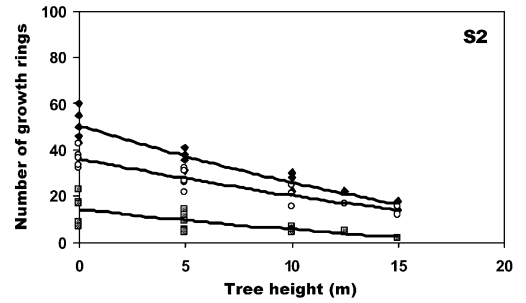
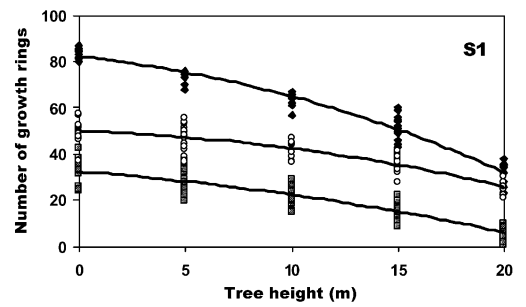

Fig. 5 Variation of total (diamonds), heartwood (squares) and sapwood (circles) growth rings along tree height for sampled sites S1–S4

and S2–S4 stands as a result of the tree age difference. In the older trees of S1, the heartwood contained on average 39%, 37%, 30% and 18% of the total number of growth rings respectively at the base, 5 m, 15 m and 20 m height levels, while for the younger S2–S4 trees this proportion was 34%, 28% and 18% respectively at the base, 5 m and 15 m in height.

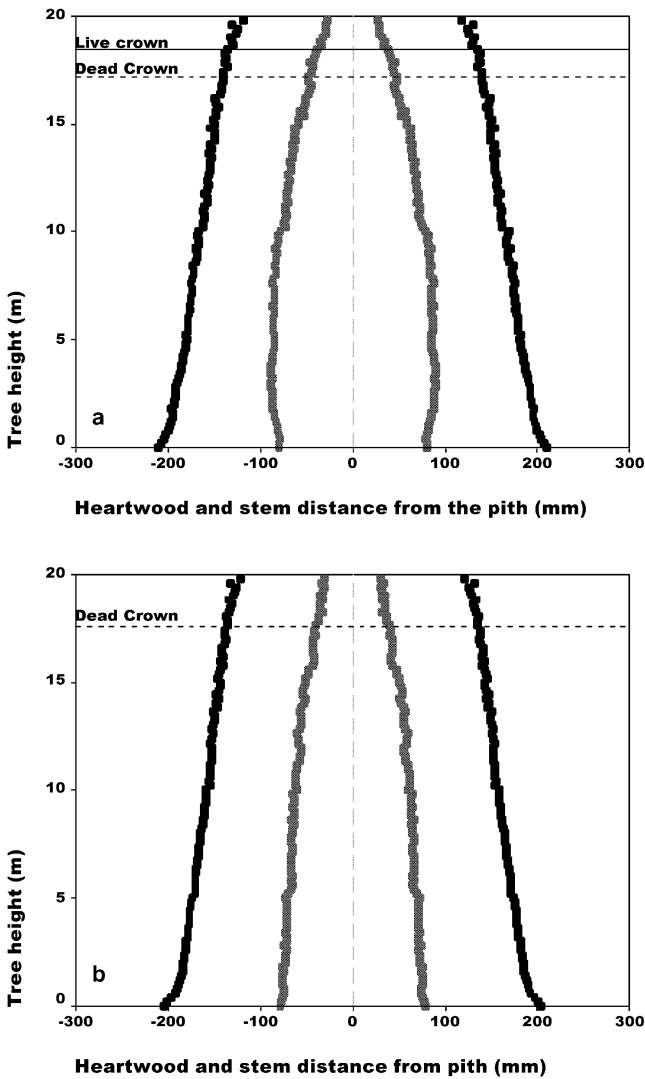

Fig. 6 Stem and heartwood profiles of two trees showing the two patterns of heartwood axial variation: (a) heartwood with a maximum diameter at a specific height; and (b) decreasing heartwood diameter along the stem

Heartwood and sapwood contents within the stems

Variation of heartwood along the stem

Figure 6 shows some examples for stem and heartwood vertical profiles. In the majority of the sampled trees (63% of the total) the heartwood radius increased from the stem base to a maximum and decreased afterwards until the top of the tree (Fig. 6a), but in some trees this maximum was not evident and heartwood tapered from the base until the top of the tree following the stem shape (Fig. 6b). The maximum heartwood radius was found at an average tree height of 3.8 m, with values ranging from 1.4 m to 6.8 m in the individual trees. For almost all trees the heartwood decreased at a faster rate after a certain height level located between the dead crown and live crown bases.

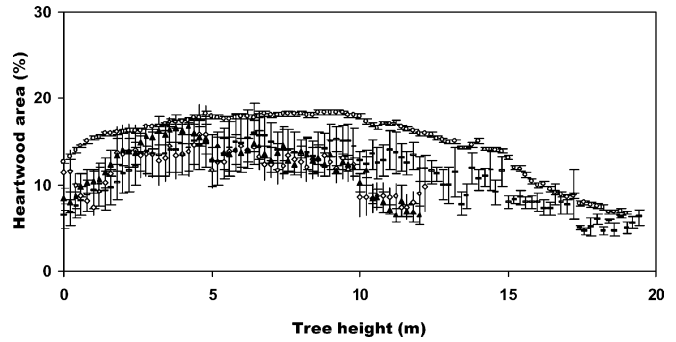

Fig. 7 Variation along stem height of the proportion of heartwood area in the stem cross section, for trees from S1 (circles), S2 (diamonds), S3 (triangle), S4 (oblong)

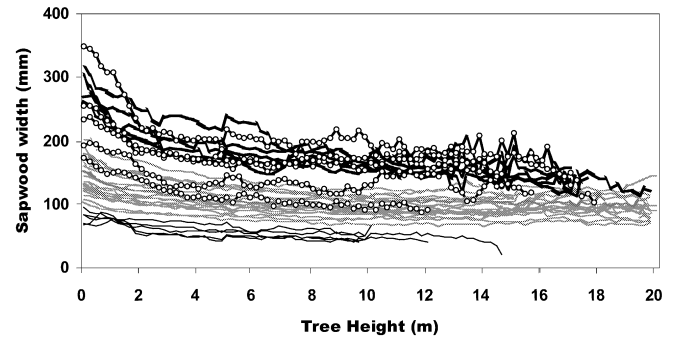

Fig. 8 Variation of sapwood width along stem height for sites S1 (grey line), S2 (thin line), S3 (dotted line) and S4 (thick line)

These variations are more visible when observing the development along stem height of the heartwood area proportion in relation to the stem cross-section (Fig. 7). The proportion of heartwood area tends to increase from the stem base to a maximum between 4 and 9 m high and then decreases to the top at the base of the dead crown. The maximum proportion of heartwood was found in S1 at 8.8 m representing 42% of the diameter and 18% of the cross-sectional area, in S3 at 4.2 m with 41% and 17%, respectively, and in S4 at 6.8 m with 39% and 16%, while for trees in S2 the proportion of the heartwood remained rather constant with stem height at approximately 17% of the tree diameter and 13% of the cross-sectional area. The increase in the heartwood proportion is higher in the first 2–3 m of the stem.

Variation of sapwood along the stem

Sapwood width was higher at the stem bases and decreased during the first 2–3 m of tree height, remaining almost constant further on along the stem height for all trees and sites (Fig. 8). The sapwood width values were similar among trees in the same site except for S3, where between-tree variability was higher. The between-tree variability in the same site was higher at the stem base,

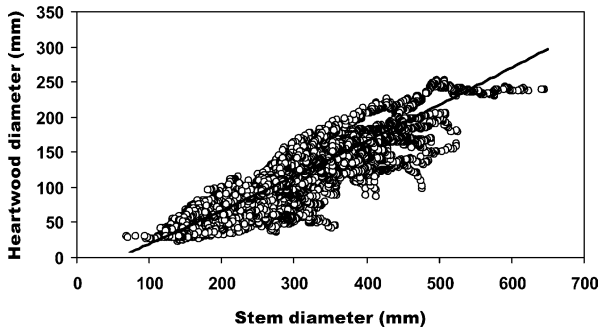

Fig. 9 Evolution of heartwood diameter with stem diameter and fitted model ($HtwD=7E^{-0.5} StemD^2+0.451 StemD -31.055$, $P<0.01$, $HtwD$ heartwood diameter, $StemD$ stem diameter)

e.g. coefficients of variation of the mean at this level ranged from 8–18% for S1, S2 and S4, to 28% in S3.

Relation of heartwood and sapwood with tree growth

As suggested by the analysis of the vertical profiles (Fig. 6), the heartwood diameter correlated strongly with the stem diameter. When considering data for all height levels of all the trees ($n=11,997$) the heartwood diameter and area showed a correlation with stem diameter of 0.89 and 0.87 respectively ($P<0.01$). When evaluating this relation for one specific height level ($n=35$), the correlations were equally high and significant (Table 4).

Figure 9 plots the stem and heartwood diameter values for all height levels of all sampled trees. For predicting heartwood diameters based on stem diameters, a second degree polynomial proved to be the best fit and accounted for 80% of the variation. According to the model, heartwood will be present for stem diameters above 6.8 cm and will increase in diameter by approximately 0.5 cm per centimetre of stem diameter increase. A linear regression also gives a good adjustment ($R^2=80\%$).

Further correlations with stem diameter are shown in Table 4. The sapwood width and cross-sectional area showed very high and positive values. The heartwood diameter proportion in percent of tree diameter correlated positively with the stem diameter but the coefficient of correlation was low and only significant at 20% of the total tree height and for all height levels.

The sapwood cross-sectional area at the live and dead crown bases had a positive and significant correlation

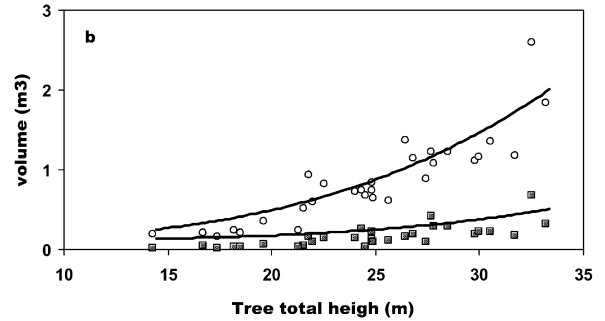
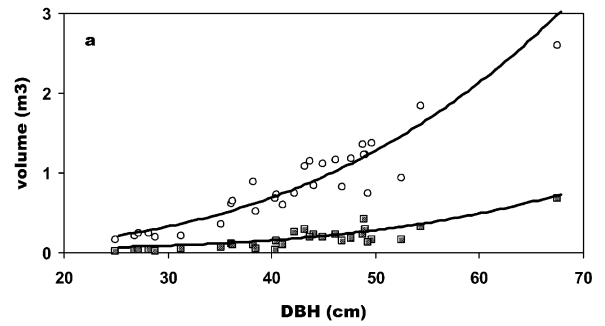

Fig. 10 Heartwood (squares) and sapwood (circles) volume as a function of DBH (a) and tree height (b), for all sampled trees

with DBH and tree total height. For S1 trees it was possible to analyse this relation with crown variables. It was found that the sapwood cross-sectional area at the crown base had a stronger and more significant correlation with the crown basal area (0.83**) than with the crown height (0.30*).

Heartwood and sapwood volumes

Heartwood represented about 17% of the stem volume in 50% of the total tree height, for S1, while for the younger stands (S2–S4) this proportion was 12–13%. For the older trees of S1, the proportion of heartwood in stem volume, on average, was 12% at the stem base, increasing to about 18% between 4–9 m in height and decreasing to 7% at 20 m high. The younger trees from S2–S3 stands showed lower proportions of heartwood volume with about 9%, 14% and 7% at the stem base, between 3 and 5 m in height, and 15 m high, respectively.

Table 4 Correlation between heartwood and sapwood dimensions and heartwood content with stem diameter for S1–S4 trees calculated using data for all height levels (for each 50 mm of stem height, $n=11,997$) and two fixed height levels (20% and 50% of total height, $n=35$)

Stem diameter	All height levels	50% of total height	20% of total height
Heartwood diameter	0.90**	0.87**	0.90**
Heartwood area	0.87**	0.83**	0.88**
Heartwood in % diameter	0.47**	0.31	0.39*
Sapwood width	0.90**	0.91**	0.89**
Sapwood area	0.98**	0.98**	0.98**

* Pearson correlation is significant at the 0.05 level (2-tailed)

** Pearson correlation is significant at the 0.01 level (2-tailed)

Table 5 Correlation between heartwood and sapwood volumes and tree biometric variables for S1–S4 trees. Stem, heartwood and sapwood total volume is the volume in 50% of total tree height

	Heartwood volume	Sapwood volume	Heartwood volume %
Stem volume	0.93**	1.00**	0.67**
DBH	0.83**	0.92**	0.39*
Tree total height	0.73**	0.87**	0.31
Height live crown	0.72**	0.76**	0.47**
Height dead crown	0.61**	0.71**	0.29
Crown height	0.18	0.42**	-0.21

Pearson correlation, $n=30$, **correlation is significant at the 0.01 level (2-tailed), *correlation is significant at the 0.05 level (2-tailed)

Table 5 shows the correlations between heartwood and sapwood volume and tree biometrics. The volumes were calculated up to 50% of the total tree height in order to minimise differences between trees. The sapwood volume of S1 trees showed a positive relation with crown area and height ($R^2=0.71$ and 0.75 respectively). The sapwood and heartwood volumes were found to be strongly correlated with total tree height (Ht) and DBH (Fig. 10).

Discussion

The heartwood content increases with tree age and various authors found evidence that, after a certain initiation age, heartwood is formed at a constant annual ring rate (Hazenberg and Yang 1991; Wilkes 1991; Sellin 1994; Bjorklund 1999; Gjerdrum 2002).

For maritime pine it was possible to predict the number of growth rings included in the heartwood with cambial age through a second degree polynomial model (Fig. 4). The heartwood formation rate was slower in younger ages with 0.5 rings year⁻¹ for ages under 55 years and 0.7 rings year⁻¹ between 55 and 83 years. For trees with similar ages (S2–S4), the variability in the number of annual rings within heartwood at a certain height level (Fig. 5) was quite low which supports the theory that heartwood progresses at a constant rate along the stem diameter.

These results parallel those of Björklund (1999) for *Pinus sylvestris* L. This author also found a second degree polynomial as the best fitting for this relation and similar heartwood development rates of 0.5 , 0.7 and 0.9 rings year⁻¹ for ages below 45, and around 90 and 115 years, respectively. For the same species, Gjerdrum (2002) predicted the number of heartwood growth rings from the square root of cambial age, finding rates of 0.6 rings year⁻¹ for a cambial age of 60 years and 0.8 rings year⁻¹ at 220 years.

In *Picea mariana*, Hazenberg and Yang (1991) also found a quadratic relation between heartwood rings and cambial age and registered lower heartwood development rates in younger than in older trees, though higher than those found for maritime and Scots pine (0.79 rings year⁻¹ at 50 years and 0.98 at 90 years).

In the present study the age of heartwood initiation was estimated to be 13 years through extrapolation of the model, while in the measured samples the first phases of heartwood formation (1–3 heartwood rings) were ob-

served in discs with cambial ages between 13 and 38 years. Esteves (2000) estimated heartwood initiation age for maritime pine to be around 20 years based on observation of stem discs at various height levels. For other pine species, heartwood initiation ages between 9 and 15 years were found by extrapolation for Scots pine (Bjorklund 1999; Gjerdrum 2002) and by direct observations, at 11 years for the same species (Morling and Valinger 1999), and 30 years for *P. canariensis* (Climent et al. 2003).

The age of heartwood formation is usually lower when estimated by fitted models than by observation of wood discs. This calls attention to the need for more data on the very early phases of heartwood formation in order to strengthen the models due to a probably higher between tree variability for the initiation of this process. Heartwood formation is under a strong genetic control though its initiation age can be influenced by environment and forest practices (Hillis 1987). This may explain the variability found for this value for the same species as given by different authors. In accordance with the previous discussion, the number of growth rings included in the heartwood decreased with stem height with a higher slope in the upper parts, leading to a decrease in the proportion of rings included in the heartwood at these stem height levels (Fig. 5).

The within tree development of heartwood and sapwood could be followed using the virtual stem reconstruction. It was possible to introduce heartwood data in the WoodCim[®] reconstruction software and to obtain a clear visualisation of its geometry together with stem geometry and knots size, position and quality (Fig. 2). These are important quality features of maritime pine stems and the information associated with the 3D models allows their study and quantification. The reconstruction of heartwood shape was a new feature added to the reconstruction module that has been already applied to the maritime pine sampled trees (Pinto et al. 2003).

For a few trees the heartwood diameter at the highest tree height levels was less or slightly more than 25 mm and accurate reconstruction was not possible since the measurements were based on a 25 mm flitch thickness. Future studies with stem parts with low heartwood content would require the use of thinner flitches for data acquisition.

The accuracy of the model regarding heartwood diameter was good and in the range previously found for stem reconstruction (Fig. 3). Differences between

heartwood diameters measured on wood discs with the reconstructed ones may arise from the different number of diameter measurements taken for the average (4 diameters in the wood discs and 12 given by the model for each cross-section), as well as from reconstruction errors at the junction of logs where the discs were taken out and the missing values had to be extrapolated.

However, the main source of differences between modelled and measured heartwood diameters was the natural irregularity of the stem shape, and they increased with pith curviness. This also occurred for stem reconstruction, where the difference between modelled and field measured stem diameters for S1 and S2–S4 logs, respectively with 14.5 mm and 27 mm average pith curviness (Pinto et al. 2002), was on average below 1% for S1 (Pinto et al. 2003) and 4% for S2 to S4 sites.

Since in maritime pine the heartwood cross-section tends to be irregular at the tree base and more regular with increasing stem height, in connection with reaction wood formation (Stokes and Berthier 2000), the description given by the model with a higher number of radial and axial measurements will better account for this irregularity and the along the stem variation of heartwood and sapwood in cross-section. Differences in stem shape between the sampled groups are related with their silviculture. In the state-owned Leiria forest (S1), with a management oriented to produce wood raw material for high added value timber products, the stems were straighter and less tapered than in the private-owned pine stands (S2–S4), without cultural operations or cleaning of undergrowth vegetation.

Overall, the within and between tree variation of heartwood and sapwood found here for the maritime pine stems follows the results reported in the literature for pine species.

Maritime pine sapwood width was much higher at the stem base than further up in the stem where it stabilized at an almost constant value after 2–3 m (Fig. 8). These results are in accordance with findings for this species (Stokes and Berthier 2000) as well as for *P. sylvestris* (Björklund 1999) where sapwood width also showed constant values after 3 m height. Stokes and Berthier (2000), following Gartner (1991) and Zimmerman (1983), commented that this higher amount of sapwood at the tree bases might be connected with a decrease in specific conductivity in this region that is compensated by a higher sapwood area.

The variability of heartwood dimensions was quite high, both between trees and between stands, in contrast to sapwood width which showed lower variation for trees belonging to the same stand. The proportion of heartwood area in the stem cross-section reflected the heartwood profile along stem height (Fig. 7) but with lower variability between tree and stand. After the crown base level there was a clear increase in the sapwood proportion.

The relation between sapwood cross-sectional area at the crown base and foliage mass was not investigated in this study. However, the sapwood area at this level and

the total sapwood volume within 50% of the tree height showed significant relations with crown dimensions (area and height) and is thereby in accordance with the pipe-model theory (Shinozaki et al. 1964).

The heartwood diameter either decreased with stem height or presented a maximum value at a specific height decreasing afterwards until the top of the tree (Fig. 6). Climent et al. (2003) also reported the occurrence of these two patterns for Canary Island pine and classified them as uniform in the first case and irregular in the second. This latter was the usual pattern for the majority of the sampled maritime pine trees and the maximum heartwood diameters were found between 1.4 m and 6.8 m. Similar profiles have been found for maritime pine in France, Spain and Portugal (Stokes and Berthier 2000; Esteves 2000; Berthier et al. 2001; Ezquerro and Gil 2001; Ferreira 2002), and for other pine species such as Scots pine (Björklund 1999; Mörling and Valinger 1999), Canary Island pine (Climent et al. 2003) and radiata pine (Wilkes 1991).

Since heartwood starts to form at a given height level and proceeds upwards and downwards along the stem (Hillis 1987) larger diameters and a higher heartwood proportion in this region are expected. In S1 trees, the maximum proportion of heartwood in the stem cross-section was found at 8.8 m, which, according with the production tables for that site, corresponded to total tree height at about 13 years of age. This was in fact the age that was estimated here for heartwood initiation.

Recently, Climent et al. (2003) have hypothesized that the peak in the heartwood vertical profile may be due to an earlier (or faster) heartwood formation in this region caused by tree sway related to the crown depth. In fact eccentric heartwood formation is related to stem eccentricity and reaction wood production (Hillis 1987; Stokes and Berthier 2000; Berthier et al. 2001), even though heartwood does not increase the bending stiffness of the trunk (Berthier et al. 2001). In *P. canariensis*, Climent et al. (2003) observed that trees with irregular heartwood had crowns in the upper half of the stem which created larger bending momentum.

However, this was not the case for the maritime pine trees studied here where the pattern of heartwood vertical variation was not related to crown dimensions. For instance in stand S2, where all the trees had an uniform heartwood profile, crown base was situated, on average, at 64% of tree height while in sites S1, S3 and S4, where most trees showed irregular profiles, these values were, 57, 59 and 70% respectively. Moreover, no relations between the crown projection area and height and heartwood profiles were found for S1 trees. The heartwood irregular profiles are therefore likely to be due to other factors, i.e. as a consequence of the increased sapwood volumes and butt swell at the stem bases.

Since heartwood develops in the tree at a constant annual rate, it is expectable that its amount will be significantly correlated with the tree biometry and variables that influence its diameter growth. This was found in this study (Table 4). Stem diameter was the best

predictor of heartwood diameter (Fig. 9). The adjustment was done through a second degree polynomial indicating that heartwood diameter will increase by approximately 0.5 cm for each centimetre of stem diameter.

Tree total height and diameter at breast height showed the highest correlation with heartwood and sapwood total volume within the tree (Table 5). Climent et al. (2003) also found total tree height and heartwood diameter at breast height as the best predictors for heartwood volume in *Pinus canariensis*. However, using considerable data from a stem bank, Björklund (1999) concluded that it is not possible to predict, using inventory data, which are the stands with higher heartwood volume production due to the high variability between trees and stands. Therefore it is necessary to increase sampling before attempting to use these two variables to predict heartwood volumes, and the correlations shown here are only indicative.

The hypothesis of predicting heartwood diameters based on stem diameters and of heartwood volumes based on tree height and DBH can be very useful for tree utilization as a raw material for the wood-based industry. When the target is to maximize heartwood content in the products, the trees can be selected by DBH and height at harvest and stem bucking can be optimized taking into account the within-stem variation of heartwood.

In conclusion, the data obtained in the present study increased our knowledge of the heartwood and sapwood development within maritime pine trees. The inclusion of heartwood in the algorithms for the stem virtual 3D-reconstruction allowed an accurate description of its volumes within a stem and, therefore, a detailed characterisation of the within-tree heartwood and sapwood development. This has a high potential of application in further studies once a sufficiently large number of trees is studied in order to account for the observed between-tree and between-stand variability. The evidence found here for maritime pine accords to the theory that heartwood initiation is an age related process, and that its development within the tree is age and growth related.

Acknowledgements Financial support was provided for the first author by a scholarship from Fundação para a Ciência e Tecnologia (Portugal) and by a Marie Curie Research Training Grant within the EU 4th RTD Framework programme. Part of the work was carried out under the research programme PAMAF 8185, financed by INIA (Instituto Nacional de Investigação Agrária, Portugal). Thanks are due to the Portuguese National Forest Service (Direcção Regional Agrária da Beira Litoral) and to SONAE Indústria and AJI Serração, who supplied the trees. Thanks for Marta Margarido and Sofia Knapic Ferreira for helping in the measurements. Special thanks are due to Tiecheng Song from VTT for all the necessary adaptations in the reconstruction programme.

References

- Bamber RK (1976) Heartwood, its function and formation. *Wood Sci Technol* 10:1–8
- Bamber RK, Fukazawa K (1985) Sapwood and heartwood: a review. *For Abstr* 46:567–580
- Bergström B (2000) Aspects on heartwood formation in Scots pine. Doctoral thesis. Department of forest genetic and plant physiology. Swedish University of Agricultural Sciences, Umeå
- Berthier S, Kokutse A, Stokes A (2001) Irregular heartwood formation in maritime pine (*Pinus pinaster* Ait.): consequences for biomechanical and hydraulic tree functioning. *Ann Bot* 87:10–25
- Björklund L (1999) Identifying heartwood-rich stands or stems of *Pinus sylvestris* by using inventory data. *Silva Fenn* 33:119–129
- Carvalho A (1997) Madeiras portuguesas, vol II—Estrutura anatómica, propriedades, utilizações. Direcção Geral das Florestas, Lisbon
- Climent J, Gil L, Pardos J (1993) Heartwood and sapwood development and its relationship to growth and environment in *Pinus canariensis* Chr.Sm ex DC. *For Ecol Manage* 59:165–174
- Climent J, Chambel MR, Pérez E, Gil L, Pardos J (2002) Relationship between heartwood radius and early radial growth, tree age, and climate in *Pinus canariensis*. *Can J For Res* 32:103–111
- Climent J, Chambel MR, Gil L, Pardos JA (2003) Vertical heartwood variation patterns and prediction of heartwood volume in *Pinus canariensis* SM. *For Ecol Manage* 174:203–211
- Cruz HLN, Machado JS (1998) Update assessment of Portuguese maritime pine timber. *For Prod J* 48:60–64
- Esteves B (2000) Influência do cerne na composição química e na deslenhificação para o Pinheiro (*Pinus pinaster* Ait.). Masters degree thesis. Instituto Superior de Agronomia, Universidade Técnica de Lisboa, Lisbon
- Ezquerria F, Gil L (2001) Wood anatomy and stress distribution in the stem of *Pinus pinaster* Ait. *Investigación Agraria. Sist Recurs For* 10:165–209
- Ferreira SKS (2002) Análise de rendimentos mássicos da indústria de serração do pinheiro bravo. Relatório do trabalho de fim de curso de Engenharia Florestal, Instituto Superior de Agronomia, Universidade Técnica de Lisboa, Lisbon
- Gartner BL (1991) Stem hydraulic properties of vines vs. shrubs of western poison oak, *Toxicodendron diversilobum*. *Oecologia* 87:180–189
- Gjerdrum P (2002) Sawlog quality of nordic softwood—measurable properties and quantitative models for heartwood, spiral grain and log geometry. Doctoral thesis. Department of Forest Sciences, Agricultural University of Norway, Ås
- Gomes S (1999) Leiria National Forest. More than a hundred years producing quality timber. In Proceedings of COST E10 2nd Workshop—Wood properties for industrial use. EFN, Mafra, pp 90–91
- Hazenberg G, Yang KC (1991) The relationship of tree age with sapwood and heartwood width in black spruce, *Picea mariana* (Mill.) B.S.P. *Holzforchung* 45:417–320
- Hillis WE (1987) Heartwood and tree exudates. Springer, Berlin Heidelberg New York
- Mörling T, Valinger E (1999) Effects of fertilization and thinning on heartwood area, sapwood area and growth in Scots pine. *Scand J For Res* 14:462–469
- Pinto I, Pereira H, Usenius A (2002) Sawing simulation of *Pinus pinaster* Ait. In: Nepveu G (ed) Proceedings of Fourth workshop on “Connection between silviculture and wood quality through modelling approaches and simulation softwares”, British Columbia. INRA, Nancy (in press)
- Pinto I, Pereira H, Usenius A (2003) Analysis of log shape and internal knots in twenty maritime pine (*Pinus pinaster* Ait.) stems based on visual scanning and computer aided reconstruction. *Ann For Sci* 60:137–144
- Sellin A (1994) Sapwood-heartwood proportion related to tree diameter, age, and growth rate in *Picea abies*. *Can J Bot* 51:737–741
- Shinozaki K, Yoda K, Hozumi K, Kira T (1964) A quantitative analysis of plant form—the pipe model theory. I. Basic analyses. *Jpn J Ecol* 14:95–105

- Song T (1987) Optimization of sawing decision making through computer simulation. Laboratory of mechanical wood technology, Helsinki University of Technology, Licentiate thesis, Espoo
- Song T (1998) Tree stem construction model for “Improved spruce timber utilisation” project. VTT Building Technology, Helsinki
- Stokes A, Berthier S (2000) Irregular heartwood formation in *Pinus pinaster* Ait. is related to eccentric, radial, stem growth. For Ecol Manage 135:115–121
- Taylor AM, Gartner BL, Morrell JJ (2002) Heartwood formation and natural durability—a review. Wood Fiber Sci 34:587–611
- Tomé M, Páscoa F, Pacheco Marques C, Tavares M (1998) Valorização do Pinhal Bravo—Intensificação cultural, modelação do crescimento e produção, gestão e planeamento estratégico. PRAXIS 3/3.2/FLOR/2120/95. Praxis, Lisbon, pp 24–30
- Usenius A (1999) Wood conversion chain optimisation. In: Nepveu G (ed) Proceedings of Third workshop in “Connection between Silviculture and wood quality through modelling approaches and simulation softwares”, La Londe-Les-Maures. INRA, Nancy, pp 542–548
- Wilkes J (1991) Heartwood development and its relationship to growth in *Pinus radiata*. Wood Sci Technol 25:85–90
- Zimmerman MH (1983) Xylem structure and the ascent of sap. Series in wood science. Springer, Berlin Heidelberg New York

Sawing simulation of *Pinus pinaster* Ait.

Isabel PINTO^{1,2}, Helena PEREIRA¹, Arto USENIUS²

¹ Centro de Estudos Florestais, Instituto Superior de Agronomia, 1349-017 LISBOA (Portugal)

² Building and Transport, P.O. Box 1806, 02044 ESPOO (Finland)



ABSTRACT

The paper deals with the sawing simulation of Maritime pine (*Pinus pinaster* Ait.) and is a report from a project aiming to increase the knowledge in how different raw material characteristics and sawing factors are affecting on the sawing yield of Maritime pine. The conversion was executed by an integrated optimising software system, WoodCIM® developed at VTT - Technical Research Centre of Finland, and was used to predict the value yield in the sawing process.

The study was based on a sample of 35 maritime pine stems randomly sampled from 4 different sites in Portugal. Based on scanning of boards and mathematical reconstruction algorithms, 3D and 2D representations were obtained for logs and stems allowing the determination and visualisation of external shape as well as of the internal knot architecture. This provides input data set for sawing simulation software for converting logs into end products. Input data concerning final products and process variables was obtained directly from the wood based industry.

The effect of some parameters on the volume and value yield of maritime pine stems was studied. Parameters include log dimensions and position within the stem, dimensions and grades of sawn timber products and saw kerf. Results were obtained through a set of simulations using different input variable combinations.

The WoodCIM® sawing simulation software has shown potential to optimise the operating instructions in the sawing process of Maritime pine and to clarify the influence of the different raw material characteristics and production parameters on the recovery of sawn timber. Virtual sawing results were close to those realised in practice when similar situations were compared.

INTRODUCTION

For an efficient raw material utilization with the best possible economical results, the wood conversion chain has to be closely integrated and optimised in its different parts. In the sawing process, yield may be investigated using three alternatives : company's statistics, trial sawing and simulations. In the practice there is always possible to carry out only limited test sawing and empirical work, which is also expensive. It is also very difficult to establish two or more exactly identical log sets and correspondingly it is difficult to keep exactly two identical processing parameter values by sawing different sets of logs. Statistics provide possibility only to analyse what has happened in the past. These are the reasons why a simulation approach is useful : information for management, decision-making and process control is provided based on mathematical models and software tools to simulate production situations.

Progress in scanning technology, defect detection and algorithms for virtual reconstruction of logs allowing the study of internal tree structure i.e. knot, heartwood and resin pockets (Oja, 1997 ; Björklund, 1999 ; Pinto *et al.*, 2003) have provided support to improve optimisation and simulation procedures.

Sawing simulation software always require extensive input data concerning products, sawing process as well as wood raw material. In some cases, data are derived from the measurement of actual logs (Tsolakides, 1969 ; McAdoo, 1969 ; Cummins and Culbertson, 1972) and simulation of virtual logs is done using computer graphics (Richards, 1973 ; Pnevmaticos *et al.*, 1974 ; Todoroki, 1988, 1990). In other cases, a growth modelling approach is used and tree models representing external and internal stem features are the input data (Leban and Duchanois, 1990 ; Meredieu *et al.*, 1999 ; Lönner and Björklund, 1999). Several research teams have developed computer programs, using input data based on scanning of logs or boards and reconstruction algorithms producing a 3D description of log/stem concerning its internal defects and shape, either derived from computer tomography (Occena and Schmoltdt, 1996 ; Schmoltdt and Araman, 1996 ; Chiorescu and Grönlund, 2000) and scanning of boards (Åstrand and Rönnqvist, 1994 ; Usenius and Song, 1997 ; Usenius, 1999, 2000).

Since the early 1970, the Wood Technology group at VTT (Technical Research Centre of Finland) has developed simulation and optimising computer software systems for the mechanical forest industry to increase the value yield and the profitability of wood converting companies (Song, 1987 ; Usenius, 1999, 2000). An integrated optimising software system, VTT-WoodCIM® , was developed that can be linked to the product and material flow control system or other computer systems at the sawmill. It consists of the following software modules :

- software for optimising selection of stands and bucking of stems,
- program for optimising the limits of sawlog classes,
- simulation program for predicting the value yield in sawmilling,
- software for optimising manufacturing components,
- sawing model based on linear programming.

For this study the WoodCIM® software was used to predict the volume and value yield in sawing, using the conversion of virtual reconstructed logs into wood products. The programme needs as input : accurate geometry of logs, geometry, quality and position of knots in the reconstructed logs, nominal and green dimensions of sawn timber products, quality requirements for each face of the sawn timber products, prices of sawn timber products and of by-products, saw kerfs, and sawing dimensions, lengths and grades.

The simulation programme calculates the sawing yield by using different sawing set-ups for each log and choosing the best combination of sawing pattern and dimensions and qualities of the sawn timber products. The results can be obtained for the entire batch of logs, for the logs from a stem or for individual logs and the output consists of the best set-up and sawing pattern, the number of sawn timber products by dimension and grade and the volume and value yield of sawn timber products.

The focus of this study is to predict the outputs of sawing components for Maritime pine (*Pinus pinaster* Ait.) using virtual logs, reconstructed from scanning images of boards and the sawing simulation of WoodCIM®. The programme was used to study the influence of raw material characteristics and production parameters on the recovery of Maritime pine sawn timber components and further to supply information to be included in real time simulation programmes. The procedures to adapt the existing software to Maritime pine, based on a set of 35 pine stems collected from four representative stands in Portugal, are described and its potential and limitations are discussed. The simulated volume and value yields are compared with recorded yields in industrial sawing.

Pinus pinaster Ait. is an important softwood for Southern Europe, covering over 3 millions ha in Portugal, Spain and France, directed to the pulp, board and sawmilling industries. In Portugal, the sawmilling industry consumes about 70% of the annual wood yield (CESE, 1996). A better knowledge of raw material characteristics and the implementation of value yield optimising software will allow a better exploitation of Maritime pine and hence an increase in the industry's competitiveness.

MATERIAL AND METHODS

Tree sampling

Thirty five maritime pine (*Pinus pinaster* Ait.) trees were randomly sampled from 4 stands in Portugal : Leiria (S1), stated owned, Mação (S2), Alpiarça (S3) and Marco de Canavezes (S4), private forest. Table 1 shows the location and main geographic and climatic conditions of each site.

Table 1 : Site characterisation.

	S1	S2	S3	S4
Coordinates ⁽¹⁾	08° 55' 55" W 39° 45' 02" N	07° 59' 49" W 39°33'14" N	08° 35' 05" W 39° 15' 36" N	08° 08' 55" W 41° 11' 08" N
Mean air temperature (°C)	12.5-15	15-16	16-17.5	12.5-15
Relative air humidity (%)	80-85	75-80	75-80	75-80
Annual rainfall (mm)	600-700	500-600	500-600	700-800
Total radiation (Kcal/cm2)	140-145	150-155	145-150	145-150

⁽¹⁾WGS84

After harvesting, total height, crown height and height of the first visible dry branch were measured. Two cross diameters (N-S, W-E) were measured every 2.5 m along the tree and bark thickness was determined with a bark gauge in the position of largest thickness. Table 2 shows the biometric data for the sampled trees.

Table 2 : Biometric characteristics of the sampled maritime pine trees (mean and standard deviation in parentheses) and site index.

	S1		S2		S3		S4	
Age	83 years		43-55 years		42-55 years		48-55 years	
Number of sampled trees	20		5		5		5	
Total height (m)	28.8	(2.8)	15.7	(3.4)	21.3	(1.0)	24.1	(1.0)
Crown height ⁽¹⁾ (m)	8.7	(2.6)	7.7	(3.5)	9.1	(1.9)	10.0	(2.0)
Height to first dry branch (m) ⁽²⁾	16.0	(2.1)	7.7	(1.2)	7.8	(1.3)	8.0	(1.6)
DBH (cm)	47.8	(7.3)	28.0	(2.3)	38.9	(9.2)	42.7	(5.3)
Bark thickness at DBH	3.4	(0.7)	3.2	(0.9)	3.5	(1.0)	4.1	(0.8)
Volume over bark (m ³) ⁽³⁾	2.7	(0.7)	0.5	(0.1)	1.3	(0.6)	1.6	(0.1)
Volume under bark (m ³) ⁽³⁾	2.3	(0.6)	0.4	(0.0)	0.9	(0.4)	1.2	(0.2)

(1) Crown height = total height - live crown base height ; crown base at the simultaneous occurrence of 2 green branches ; (2) Height from tree base to the first visible dry branch ; (3) Precise cubic method, Smalian formula.

Sawing simulation

The sawing simulation software of WoodCIM® was used to estimate the production of lumber and boards. The software module used is flexible, subject to modifications to match the requirements for the adaptation to a new species and processing conditions and allows the free specification of product dimensions and qualities, concerning size and number of knots. The software was reconfigured for Maritime pine, i.e. in the input data the number of sawing patterns was increased up to 100 and the number of widths allowed to each sawn product was also increased.

Input raw material for virtual sawing

The wood raw material used in this study for the sawing simulations is a set of virtual logs, which are mathematically reconstructed logs based on the so-called flitch method. The sample trees were cross cut into a total of 133 logs and live sawed into 25 mm thick flitches. The flitches were scanned using WoodCIM® camera system providing RGB (colour component) information stored in the computer files for further processing and analyses. The measured data was computed by VTT's PuuPilot software showing the image of the flitch on the screen. The data concerning the geometrical and quality features of the flitch was processed with a dedicated software producing a mathematical reconstruction of a log or of a stem in xyz-co-ordinate system (Song, 1987 ; Song, 1998). 3D and 2D representations were obtained for logs and stems (Fig. 1) allowing the visualisation of external shape as well as of the internal knot architecture, including its quality (sound, dry or rotten knot). The reconstructed logs include also a 3D visualisation of the heartwood. The position in the tree as well as the compass orientation is known for all logs.

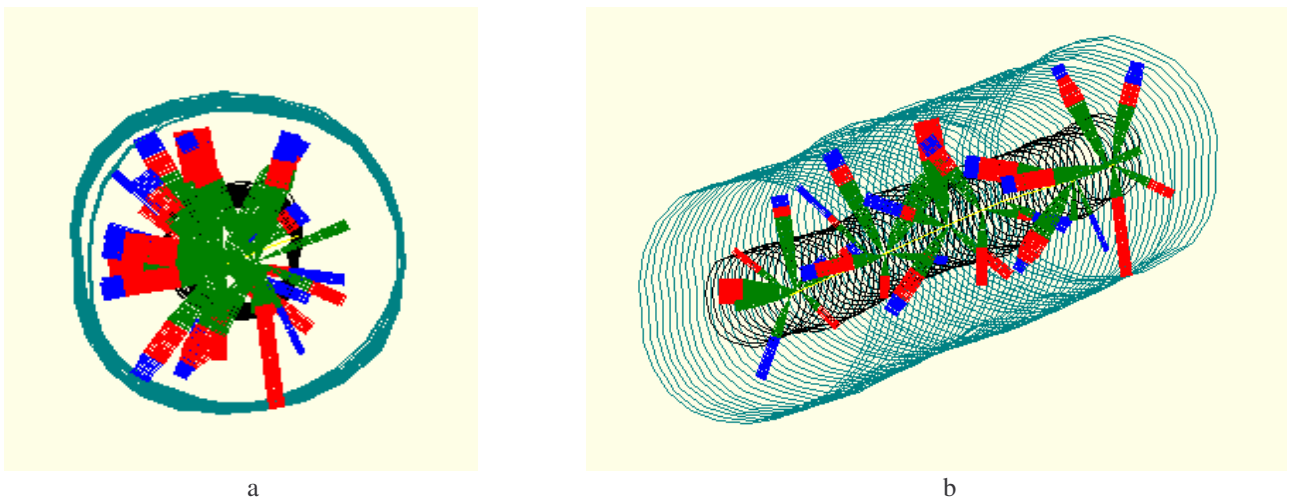

Figure 1 : Mathematically reconstructed log of maritime pine showing the geometry of the log, the internal knots and heartwood in 2 (a) and 3 (b) dimensions.

In the description of log external shape the reconstruction gives as output 24 radial vectors per each cross-section of the log with 20 mm between neighbouring cross-sections. Taper was calculated for each log from the slope of the line marking the external limit of diameters determined every 50 mm of length. The diameter is the average of all vectors that define each cross-section. Pith curviness is the maximum deviation (in any direction) of pith found along the log in relation to an imaginary axis of a straight pith.

The entire stem can be reconstructed by joining its different reconstructed logs and this virtual stem can then be cross cut into any desired log length. For this study the 35 maritime pine reconstructed stems were cross cut into a total of 218 logs with 2.6 m length. This length was set according with the Portuguese sawmill industry information, as it represents around 90% of the log length consumed.

Table 3 shows the log characteristics. The top diameters of the 218 sawn virtual logs varied between 91 and 530 mm, with 65% within 200-300 mm. The simulation results concern a total of 216 logs since two logs were not virtually sawn because their diameter was too small for the given sawing pattern.

Table 3 : Average and range of values for log top diameter, taper and pith curviness according with origin.

	S1	S2	S3	S4
Number of logs	138	20	27	33
Diameter (mm)				
Range	180 - 530	91 - 198	133 - 391	129 - 341
Average	319.6	154.2	221.1	242.6
Taper (mm/m)				
Range	1 - 30	1 - 24	1 - 46	1 - 31
Average	9.3	9.8	12	10.8
Pith curviness (mm)				
Range	0 - 65	10 - 52	1 - 97	10 - 108
Average	14.5	25	21.8	34.8

Input process parameters

The input data used in the simulations concerning product dimensions, quality, prices and sawing patterns were obtained from a Portuguese sawmill industry. The simulations were done for lumber with 50 and 70 mm thickness and 100 mm width and boards with 25 mm thickness and widths from 100 to 200 mm. The length of all sawn products was 2.5 m. No wane edge was allowed in any sawing product. Only green dimensions were used so the results are green sawing yields. Sawkerf was 2.5 mm for the live-sawing.

For sawing lumber and boards, 35 different sawing patterns were given as input (lumber products taken from the middle of the log and boards from sides). The programme tries all the sawing patterns for the given log diameter and chooses the one that results in the best value yield.

Regarding the quality of sawn timber products, the programme uses as input specification the number and size of knots allowed in each of the four faces of the component. Three grade classes were considered for boards (Tab. 4) in relation to the presence of defects in the two wide faces of the boards. The narrow faces of boards and lumber pieces had no restrictions.

Table 4 : Quality grades of boards used in the simulation.

	Wide face 1	Wide face 2
Grade 1	maximum 1 sound knot	maximum 4 knots (sound or dry)
Grade 2	maximum 4 knots (sound or dry)	no restrictions
Grade 3	no restrictions	no restrictions

RESULTS AND DISCUSSION

Raw material characterization

The overall top diameter distribution for the 216 logs is shown in Figure 2. A large between log variation was found, with logs ranging from 50 mm to 500 mm top diameters. Most logs were included in the 30-35 cm (24%), 25-30 cm (21%) and 20-25 cm (20%) diameter classes.

The trees sampled showed different sizes in the four stands (Tab. 2) from which resulted logs with different average characteristics (Fig. 3). In the state-owned Leiria forest (S1), management is oriented to produce wood raw material for high added value timber products. Silviculture consists in 5-year rotation thinnings between 20 and 40 years of tree age, pruning before the first thinning and clear cutting at an approximate age of 80 years (Gomes, 1999). Therefore, from the set of logs used in this study, the logs from Leiria (S1) showed the highest average top diameter and lowest taper and pith curviness (Fig. 3). These logs are probably a part of the best quality fraction available in Portugal for the sawmilling industry.

In the private-owned Portuguese pine stands (S2, S3, S4) rotation is about 40-50 years. In most of the cases there are no cultural operations and no cleaning of undergrowth vegetation. Site 2 showed the worst site growth and the logs obtained from the sampled trees had the smallest diameters (Fig. 3).

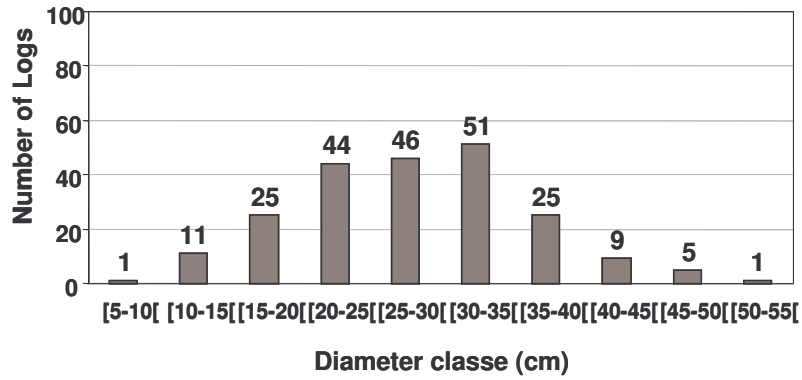

Figure 2 : Number of virtual logs classified by top diameter.

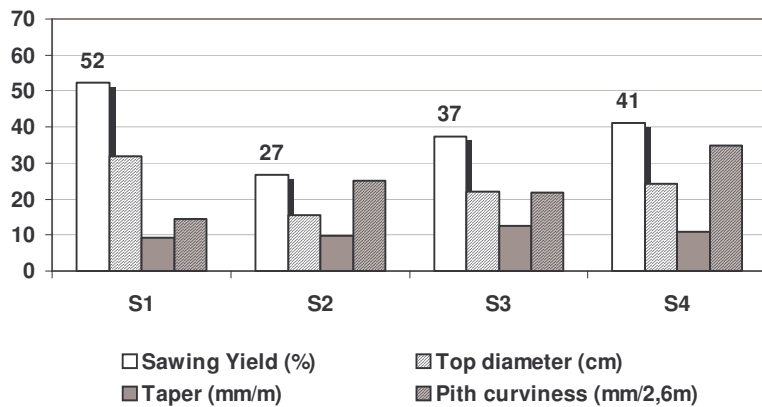

Figure 3 : Average top diameter, taper, pith curviness and volume yield of sawn timber products from logs from the different sites.

Sawing yields

The overall average volume yield in the simulated sawing of 216 logs was 51%, if no specific quality requirements or prices were defined. When considering logs classified by top diameter class (Fig. 4), the volume yield increased with diameter with maximum values of 59% corresponding to the sawing of logs in the 40-45 cm and 45-50 cm diameter classes. The smallest diameter class yielded only 14% in sawing products.

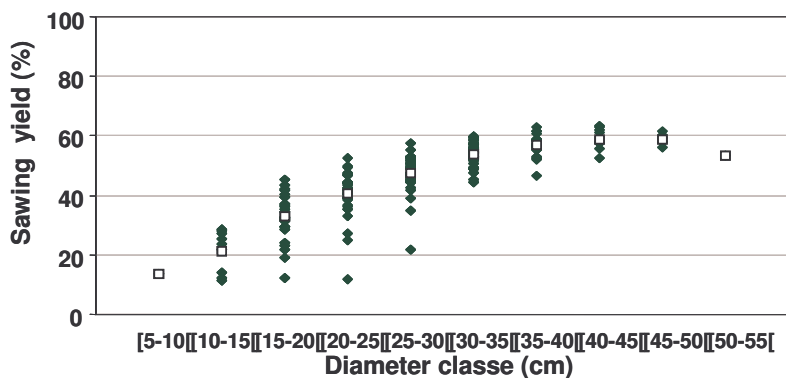

Figure 4 : Yield of sawn products and average log yield by top diameter classes.

The variability of the values inside each class is high, especially in the range of diameters between 10 and 25 cm due to the variability in log taper and curviness as well as due to the different origin of the trees. Figure 3 shows the yield of sawn timber products, top diameter, taper and pith curviness values for the logs from the 4 different sampled sites.

The best sawing yield (52%) was obtained with the logs from Leiria (S1) in accordance with the larger diameters and lower pith curviness and taper when compared to the other stands (S2, S3 and S4). The lowest sawing yield of only 27% of sawn products was obtained for the S2 logs, which had the smallest diameters.

Value optimised sawing yields

Figure 5 shows the yield of sawn timber products when the sawing simulations were executed considering quality grades for the boards (value optimised) and compared with the yields obtained without quality specification (volume optimised).

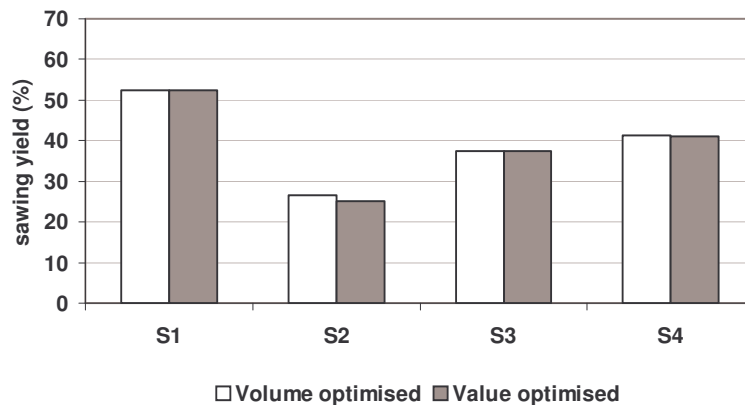

Figure 5 : Yield of sawn timber products when the sawing simulation is executed value or volume optimised.

The overall sawing yield decreases with the introduction of quality specifications of the boards (51.6% vs. 50.9%). The differences are not very high and only noticeable in the smallest logs from site S2 (Fig. 5). In fact in the sawing patterns used in the simulations, boards were sawn from the outer parts of the log while lumber was taken from the inner part containing most of the knot core. Therefore, for the larger logs, the sawing pattern selected by the programme when quality specifications for boards were introduced in the input data was the same, or very similar, to the pattern selected without quality specifications. For logs with smaller diameters, the differences in sawing yields will be higher as most of these are top logs in the stem with a larger knot core.

The average economic value of sawn products, sawdust and chips obtained per cubic meter of raw material, is shown in Figure 6 for each log diameter class. The obtained value yield increases strongly with log diameter class from a low value of 35 €/m³ for the 5-10 cm diameter class to 105 €/m³-107 €/m³ for the 40-45 and 45-50 cm diameter classes.

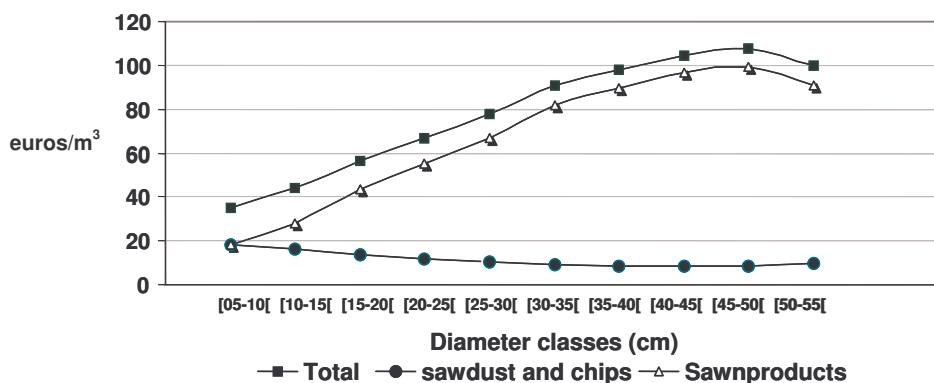

Figure 6 : Value of sawn products, sawdust and chips obtained per m³ of raw material for different log diameter classes.

Figure 7 shows the yield of sawn timber products for logs in different positions in the stem, when quality grades are defined in the input data. Yield decreases from butt to top logs due to the diameter decrease and knot volume proportion increase. The study of the 3D reconstructed stem internal knot structure of the 20 trees from site 1 (Pinto *et al.*, 2000) has shown that the knot core increases with tree height, with the proportion of knots increasing significantly from butt to top logs.

In the case of S3 trees the yield of butt logs was similar to middle logs. For these trees, butt swell was very evident and taper values were high (Tab. 3). A sawing simulation done with the same input data but cross cutting the first log 1m from the butt to avoid butt swell, results in an average 8% increase in the sawing yields for butt logs.

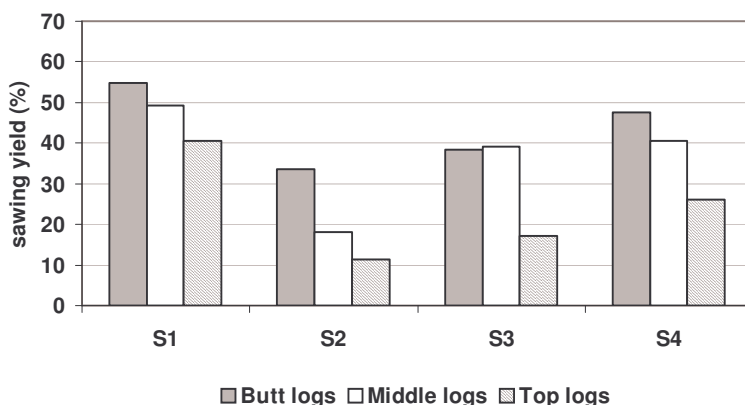

Figure 7 : Yield of sawn timber products with quality grade specification for butt, middle and top logs from the different sampled sites.

Figure 8 shows the grade distribution of the sawn boards when sawing simulations were executed for maximising value yield, considering the following relative selling prices of boards : 1st grade : 100 ; 2nd grade : 73 and 3rd grade : 57.

The software searches a solution that maximizes the total value of the products taking into account each single knot inside the log and the rules for the grading of products (Tab. 4). The final sawing solution is very much depending on the prices of products defined by dimensions, lengths and grades. Overall, first grade boards were 79% of the total volume of boards when all the logs were sawn together. A higher proportion of 1st grade boards was obtained from logs from site S1 where 80% of the boards volume fell in the best grading class, while first grade boards corresponded to only 58% of the total boards volume from logs from the other sites. This large difference in the yields obtained for first quality boards between sites is a result from the fact that in site S1 butt logs have been pruned. This stresses the importance of pruning maritime pines at early stages because the tree has well branched first crown whorls and a weak natural pruning (Tavares, 1999).

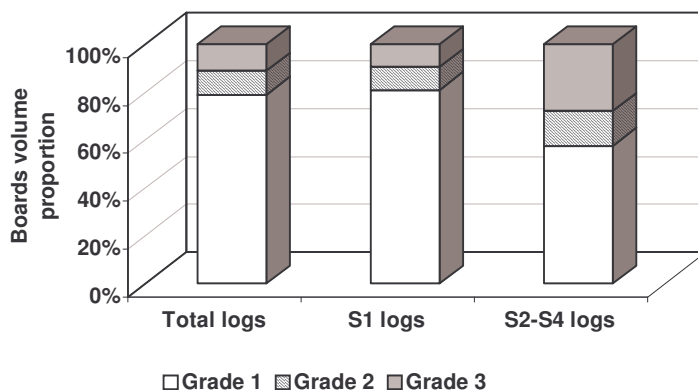

Figure 8 : Volume proportion of 25 mm boards by quality grades in value optimised sawing simulations for the total of the logs, for S1 logs, and for S2, S3 and S4 logs.

Influence of sawkerf

The influence of sawkerf on sawing yield was simulated by changing the sawkerf. Sawing yield is 55% when a theoretical sawkerf is 0 mm. Yield drops to 46%, when a 6 mm sawkerf is used in sawing. By increasing sawkerf by 1 mm, the yield decreases in average by 3%, which means a loss of 4,5 €/m³ raw material used. Figure 9 shows the variation in the sawing yield by changing the sawkerf for three different diameter classes. The influence in yield by the increase of sawkerf is higher for larger diameters.

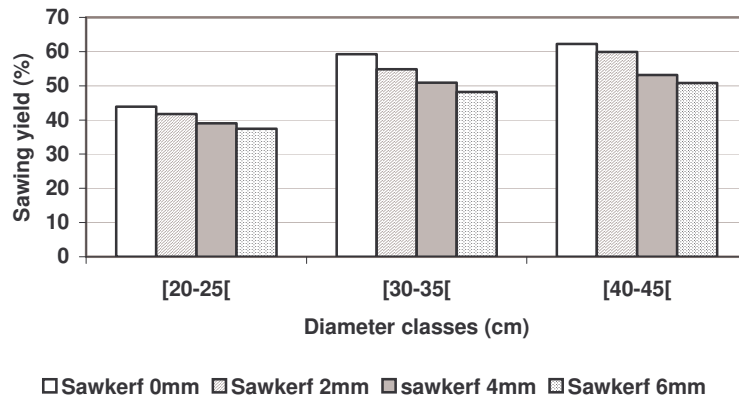

Figure 9 : Variation of yield of sawn timber products with the increase of sawkerf.

Comparison of simulation outputs with industrial yields

Comparison of simulated with industrial sawing yields was made using the results of Ferreira (2002) who measured yields of maritime pine logs in a Portuguese sawmill. In this study, the top diameters of logs sawn into lumber and boards ranged from 214 mm to 276 mm and their position in the tree was 1st, 2nd or 3rd. The average volume yield of sawn timber products calculated for these logs was 45.9 % (st. dev = 5.6 %).

From the 218 virtual logs used in the present simulation, 16 logs had the same top diameters and position in the tree and were used as the input raw-material for one sawing simulation. The average simulated sawing yield for these logs was 46.2 % (st. dev = 5.1 %) and the sawing pattern used in the simulation was similar to that used in the mill. The simulated sawing matches well the sawing in a real industrial environment which means that the software can be used to produce useful information for sawmills utilising Maritime pine wood raw material.

CONCLUSION

The WoodCIM® sawing simulation software has shown potential to optimise the operating instructions in the sawing process of Maritime pine and to clarify the influence of different raw material characteristics and production parameters on the recovery of sawn timber. Virtual sawing results were close to those realised in practice when similar situations were compared.

This study will contribute to increase the knowledge on the variations of Maritime pine sawing yield outputs with different factors and to connect these results with raw material main characteristics. The preliminary results presented in this paper indicate that there is a need to continue the studies to create new useful information to the industry, such as bucking instructions and limits of log classes based on the information regarding external shape and internal defects in order to increase value of the production. Further work will consist in adding new features into the sawing simulation, e.g. taking into account annual growth rings, resin pockets and heartwood content in the logs.

ACKNOWLEDGMENTS

Financial support was given to the first author by a scholarship from Fundação para a Ciência e Tecnologia (Portugal) and by a Marie Curie Research Training Grant within the EU 4th RTD Framework programme. Part of the work was carried out under the research programme PAMAF 8185, financed by INIA (Instituto Nacional de Investigação Agrária, Portugal). Thanks are due to the Portuguese National Forest Service (Direcção Regional Agrária da Beira Litoral) and to SONAE Indústria and AJI Serração, who supplied the trees. Special thanks are due to Tiecheng Song from VTT for all the necessary adaptations in the simulation programme.

REFERENCES

- 📖 Åstrand E., Rönnqvist M., 1994 : Crosscut optimization of boards given complete defect information. Forest Prod. J., 44(2), 15-24.
- 📖 Björklund L., 1999 : Identifying heartwood-rich stands or stems of *Pinus sylvestris* by using inventory data. Silva Fenn., 33(2), 119-129.

- 📖 **CESE**, 1996 : O sector florestal português. Documento de apoio ao seminário do CESE, Conselho Ensino Superior-Empresa. Grupo de trabalho sobre o sector florestal. Póvoa do Varzim, 4-5 Outubro (in Portuguese).
- 📖 **Chiorescu S., Grönlund A.**, 2000 : Validation of a CT-based simulator against a sawmill yield. *Forest Prod. J.*, 50(6), 69-76.
- 📖 **Cummins L.K., Culbertson D.D.**, 1972 : Sawmill simulation model for maximizing log yield values. *Forest Prod. J.*, 22(10), 34-40.
- 📖 **Ferreira S.K.S.**, 2002 : Análise de rendimentos mássicos da indústria de serração do pinheiro bravo. Relatório do trabalho de fim de curso de Engenharia Florestal, UTL - Instituto Superior de Agronomia, Lisboa, 65pp.
- 📖 **Gomes S.**, 1999 : Leiria National Forest – More than a hundred years producing quality timber, *in* Proceedings of COST E10 2nd Workshop – Wood properties for industrial use. Ed. EFN, Mafra (1999), 90-91.
- 📖 **Leban J.M., Duchanois G.**, 1990 : SIMQUA : A simulation software for wood quality. *Annales des Sciences Forestières*, (47), 483-493.
- 📖 **Lönnner G., Björlund L.**, 1999 : Value optimised cross-cutting and sawing patterns applied on tree models : some cases. Proceedings of the Third Workshop IUFRO WP S5.01.04 " Connection between silviculture and wood quality through modelling approaches and simulation software ", La-Londe-Les-Maures, France, September 5-12, 1999, Nepveu Editor, 488-492.
- 📖 **McAdoo J.C.**, 1969 : Computer simulation of small-log mill processing. *Forest Prod. J.*, 19(4), 34-35.
- 📖 **Meredieu C., Dreyfus P., Saint-André L., Leban J.M.**, 1999 : A chain of models from tree growth to properties of boards for *Pinus nigra* ssp. *Laricio* Arn. : simulation using CAPSIS[®]_{INRA} and WinEpIFN[®]_{INRA}. Proceedings of the Third Workshop IUFRO WP S5.01.04 " Connection between silviculture and wood quality through modelling approaches and simulation software ", La-Londe-Les-Maures, France, September 5-12, 1999, Nepveu Editor, 505-513.
- 📖 **Occena L.G., Schmoldt D.L.**, 1996 : GRASP-A prototype interactive graphic sawing programme. *Forest Prod. J.*, 46(11/12), 40-42.
- 📖 **Oja J.**, 1997 : Measuring knots and resin pockets in CT-images of Norway spruce. Division of Wood Technology, University of Technology, Luleå, Licenciate thesis, Skellefteå, 6pp.
- 📖 **Pinto I., Pereira H., Usenius A.**, 2003 : Analysis of log shape and internal knots in twenty Maritime pine (*Pinus pinaster* Ait.) stems based on visual scanning and computer aided reconstruction. *Annals of Forest Science*, (60), 137-144.
- 📖 **Pnevmaticos S.M., Dress P.E., Frayer W.E.**, 1993 : Log and sawing simulation through computer graphics. *Forest Products J.*, 24(3), 53-55.
- 📖 **Richards D.B.**, 1973 : Hardwood lumber yield by various simulated sawing methods. *Forest Prod. J.*, 23(10), 50-58.
- 📖 **Schmoldt D., Li P., Araman P.**, 1996 : Interactive simulation of hardwood log veneer slicing using CT images. *Forest Prod. J.*, 46(4), 41-47.
- 📖 **Song T.**, 1987 : Optimization of sawing decision making through computer simulation. Laboratory of mechanical wood technology, Helsinki University of Technology, Licenciate thesis, Espoo.
- 📖 **Song T.**, 1998 : Tree stem construction model for «Improved spruce timber utilisation» project. VTTs Building Technology internal report, 20pp.
- 📖 **Tavares M.**, 1999 : Maritime pine wood quality in Portugal, a few reasons responsible for some of its characteristics and defects. In Proceedings of COST E10 2nd Workshop–Wood properties for industrial use. Ed. EFN, Mafra (1999), 81-87.

- 📖 **Todoroki C.L.**, 1988 : Seesaw : A visual sawing simulator as developed in version 3.0. New Zealand J. Forestry Sci., 18(1), 116-123.
- 📖 **Todoroki C.L.**, 1990 : Autosaw systems for sawing simulation. New Zealand J. Forestry Sci., 20(3), 332-348.
- 📖 **Tsolakides J.**, 1969 : A simulation model for log yield study. Forest Products J., 19(7), 21-26.
- 📖 **Usenius A.**, 1999 : Wood conversion chain optimization. Proceedings of the Third Workshop IUFRO WP S5.01.04 " Connection between silviculture and wood quality through modelling approaches and simulation software ", La-Londe-Les-Maures, France, September 5-12, 1999, Nepveu Editor, 541-548
- 📖 **Usenius A.**, 2000 : WoodCim® - Integrated planning and optimizing system for sawmilling industry. VTTs Building Technology internal report, 8pp.
- 📖 **Usenius A., Song T.**, 1997 : Relating the product specification to the value yield in the wood conversion. Proceedings of the Second Workshop IUFRO WP S5.01.04 " Connection between silviculture and wood quality through modelling approaches and simulation software ", Berg-en-Dal, Kruger National Park, South Africa, August 26-31, 1996, Nepveu Editor, 214-219.

Simulated and realised industrial yields in the sawing of maritime pine (*Pinus pinaster* Ait.)

ISABEL PINTO^{a*}, SOFIA KNAPIC^b, HELENA PEREIRA^b, ARTO USENIUS^a

*corresponding author: Tel. +358 9 456 5565, fax +358 9 456 7027, e.mail isabel.pinto@vtt.fi

^a *VTT Building and Transport, P.O.Box 1806, FIN-02044 VTT, Finland*

Tel. +358 9 456 5540, fax +358 9 456 7027

^b *Centro de Estudos Florestais, Instituto Superior de Agronomia,*

1349-017 Lisboa, Portugal

Tel. +351 21 3634662, fax +351 21 3645000

Acknowledgements: Financial support was given to the first author by a scholarship from Fundação para a Ciência e Tecnologia (Portugal) and by a Marie Curie Research Training Grant within the EU 4th RTD Framework programme. Part of the work was carried out under the research programme PAMAF 8185, financed by INIA (Instituto Nacional de Investigação Agrária, Portugal). Thanks are due to the Portuguese National Forest Service (Direcção Regional Agrária da Beira Litoral) and to SONAE Indústria and AJI Serração, who supplied the trees and, in the last case, supported the industrial study. Special thanks are due to Tiecheng Song from VTT for all the necessary adaptations in the reconstruction programme.

Abstract: A sawing simulation software was evaluated by comparison with a real situation in the industrial sawing of maritime pine (*Pinus pinaster* Ait.) stems. At an operational sawmill sawing yields were measured for the conversion of logs with two sawing patterns: production of boards and production of boards and lumber. The simulation used the WoodCIM® optimisation software with similar sawing set-ups and dimensionally matching virtual logs obtained from cross cutting of 3D mathematical reconstructions of maritime pine stems. The virtual maritime pine stems and the sawing simulation software showed potential to evaluate the impact of raw material and process characteristics on the production performance. The simulated sawing yields corresponded closely to the industrial yields for the production of boards (57% volume yield). For production of lumber and boards, the simulation allowed to obtain a higher volume (45% vs. 53%). The negative impact of resin production on the sawing yields was estimated by comparing the industrial yields of resin tapped trees with matching virtual logs and showed to lead to a loss of 11% sawn wood volume, and increasing with log diameter.

1 INTRODUCTION

The efficiency of the sawing process has always been a key issue for the optimisation of the whole wood conversion chain where the primary and secondary conversion industries provide the link between customer's needs and forest production.

The development of machine vision systems and of sawing simulation models has provided tools that can be used to test different scenarios in a virtual world, thereby supporting product and production research and creating information for management, decision-making and process control.

A good model for the wood raw material is required for a virtual sawing capable of predicting quality distribution of the sawn products resulting from the conversion simulations. Progress in scanning technology, defect detection and algorithms for virtual reconstruction of logs allows to study tree shape and internal structure *i.e.* knot, heartwood and resin pockets (Oja 1997; Bjorklung 1999; Pinto et al. 2003, 2004) providing support to improve optimisation and simulation procedures.

During the past 30 years there has been a strong development in optimisation studies of the wood conversion chain with a close interaction between research centres and industry. Wood sawing simulators have been designed and improved in order to reach an accurate virtual wood conversion chain linking raw material properties to industrial production and products, for planning purposes (Hallock et al. 1978, Leban and Duchanois 1990, Schmoldt et al. 1996, Todoroki 1996, Usenius 1999). The impact on sawing yields of specific conversion variables and scenarios has been analysed using the virtual sawing of logs and trees (Richards 1973, Todoroki 1994, Maness and Lin 1995, Pinto et al. 2002, Ikonen et al. 2003).

However, for an efficient use of the information provided by models and simulations it is important to evaluate the differences between the results obtained in the real practice and the simulated outputs. Only few studies have been presented in the literature dealing with this subject. Grundberg (1999) compare the results of a virtual sawmill with the real sawing and manual grading at a single-log level. This sawing simulation system was also validated against a 1-year production of a medium size sawmill (Chiorescu and Grönlund, 2003).

The objective in this study was to evaluate the performance of a sawing simulation software (WoodCIM®) with maritime pine logs (*Pinus pinaster* Ait.) by comparison of the

predicted output with a real situation from an operational sawmill, where production yields were measured (Knapic et al. 2004). WoodCIM® is an integrated optimising software system, developed at VTT - Technical Research Centre of Finland (Usenius 1999, 2000). The module for sawing simulation has been adapted for maritime pine and used to study potential sawing yields in different scenarios for this species (Pinto et al. 2002, 200_). The input raw material for the simulations was virtual logs cross-cut from maritime pine stems that were 3D mathematical reconstructions, based on scanned images of flichthes, including the representation of internal knots and heartwood (Pinto et al 2003, 2004). Similar sawing set-ups were used in the simulation runs as in the sawmill and the predicted yields were compared with those effectively obtained.

2 MATERIAL AND METHODS

A sample of maritime pine (*Pinus pinaster* Ait.) stems was selected, cross-cut into logs and sawn at a Portuguese sawmill. Sawing yields were measured at the mill (Knapic et al. 2004) and compared with yields obtained by simulating the sawing of a similar sample of logs selected from a virtual pool of 3D reconstructed maritime pine stems. The bucking and sawing simulation modules of WoodCIM® were used after adaptation for this species (Pinto et al. 2002). Figure 1 shows the main steps of the comparison between industrial and simulated sawing yields.

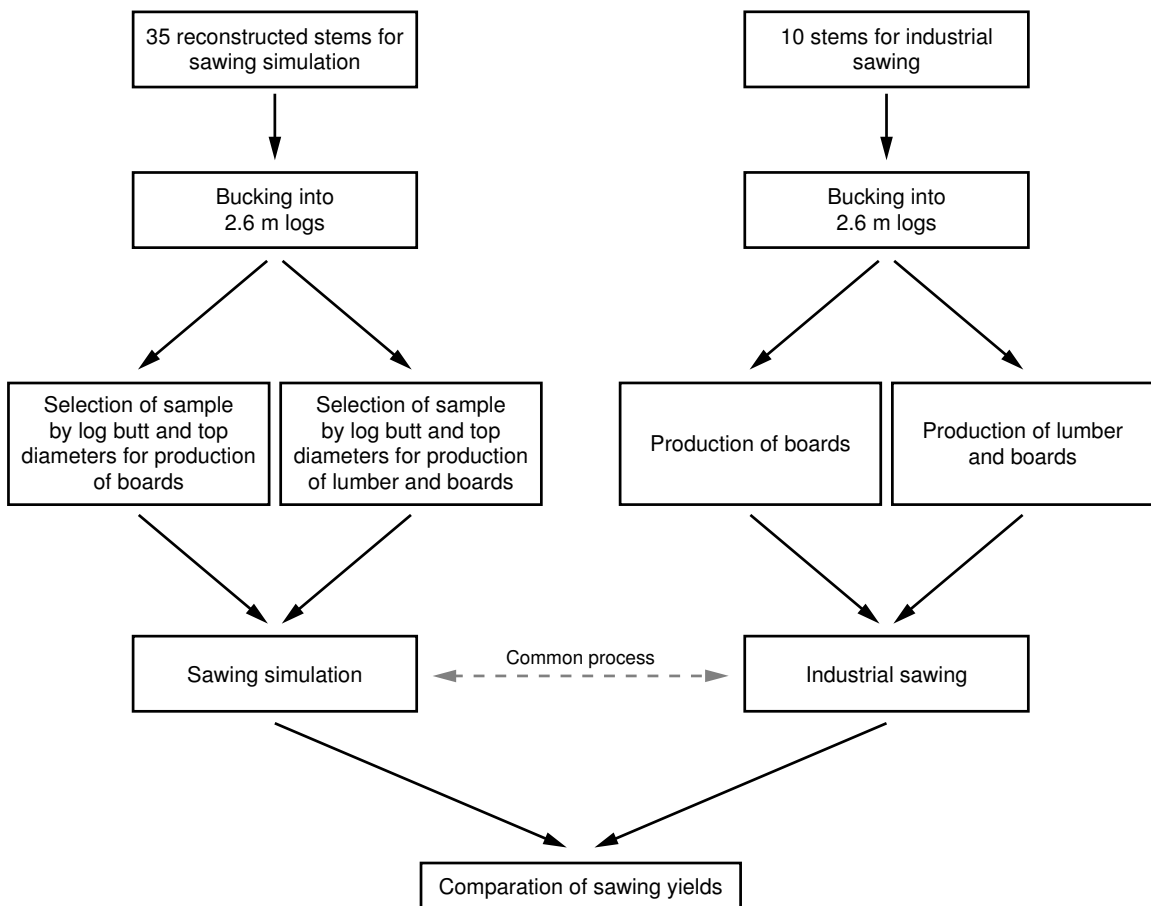

Figure 1: Main steps for the industrial and sawing tests

2.1 Industrial sawing

2.1.1 Raw material

A sample of ten trees of maritime pine was randomly chosen from a stand in Portugal. Six trees were resin-tapped and showed the wounding streaks in the lower part of the stem. The trees were bucked and cross-cut into logs of different lengths according to their final end uses. For this study only 2.6 m logs were taken as used in the production of boards and lumber. Tree and log characteristics are described in Table 1.

Table 1: Sample tree biometry and main log parameters for industrial and simulation study (Average plus SDEV)

	<i>Industrial test</i>	<i>Virtual test</i>
<hr/> <i>Sampled Trees</i> <hr/>		
<i>Number</i>	10	35
<i>Age</i>	70 (8)	69 (17)
<i>DBH (cm)</i>	34.6 (4.1)	43.0 (9.6)
<i>Height (m)</i>	19.3 (2.1)	25.4 (5.0)
<i>Volume⁽¹⁾ (m³)</i>	0.5 (0.2)	1.7 (0.9)
<hr/> <i>Sawlogs</i> <hr/>		
<i>Number</i>	29	218
<i>Diameter butt (mm)</i>	280.2 (58.1)	305.0 (89.0)
<i>Diameter top (mm)</i>	241.3 (32.9)	281.3 (81.3)
<i>Taper⁽²⁾ (mm/m)</i>	9.4 (7.8)	9.9 (6.4)
<i>Volume⁽³⁾ (m³)</i>	0.1 (0.1)	0.2 (0.1)

(1) Volume under bark - Smalian formula

(2) Slope of the line marking the external limit of diameters determined every 50 mm of length

(3) Volume under bark

2.1.2 Sawing

Two sawing patterns were used (Figure 2): single production of boards or mixed production of boards and lumber (centre pieces). The boards were cut with the maximum allowed width. The products dimensions are indicated in Figure 2. The first cut was made with the head ridge saw on a direction parallel to the log axis, *i.e.* live sawing. The second cut edged the boards and lumber in order to avoid any wane, being responsible for the correct board width and lumber thickness. The third cut squared the end of the sawn pieces at the final length.

The production yield was calculated by taking measurements at a series of critical points along the production line. After the first cut, thickness and width were measured every 5 cm along the sawn products. The same procedure was repeated after the second and third cuts, but only one measure was taken due to the geometry of the products. The production yield was calculated as the proportion of the final production volume in the total raw material volume, based on the green dimensions. Log volume was calculated geometrically as a truncated cone with butt and top diameter measurements.

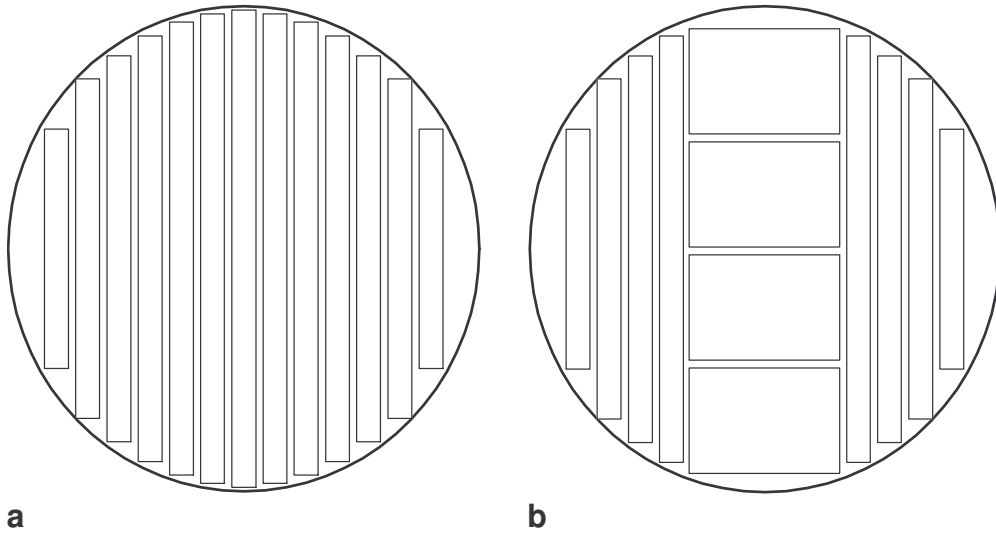

Figure 2: Sawing patterns – Single production of boards (2a) and mixed production of lumber and boards (2b). Lumber dimensions: 50/70 x 100 x 2500 mm. Board dimensions: 25 x 90 - 250 (each 5 mm) x 2500 mm. Saw kerf: 2.5 mm.

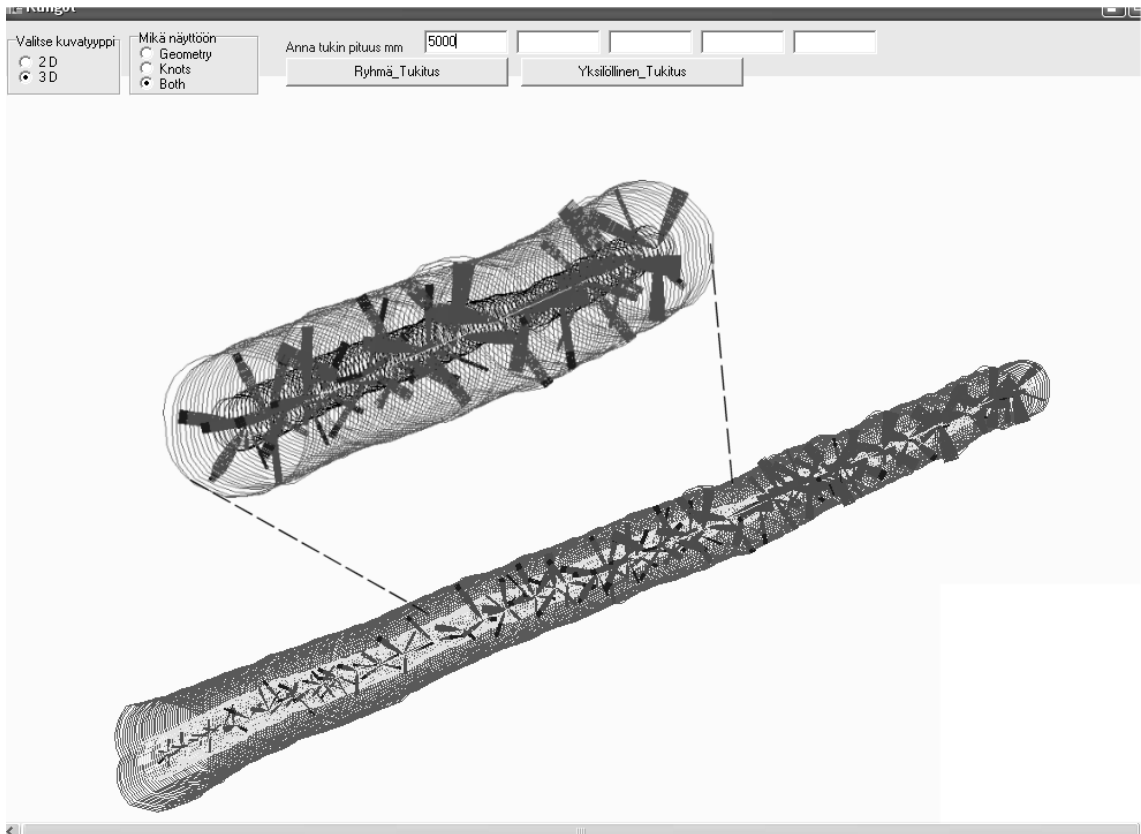

Figure 3: 3D representations for one maritime pine stem and one bucked log

2.2 Virtual sawing

2.2.1 Sampling raw material

The sawing simulation was made with logs selected from a set of 35 virtual 3D stems, which were mathematical reconstructions of maritime pine trees randomly harvested from four stands in Portugal. Data concerning forest stand and tree biometry were detailed in Pinto et al. (2004). The virtual representation of the maritime pine stems was based on the computing of scanned images of flitches (Song 1987,1998, Usenius 1999) and included geometrical and quality features (*i.e.* heartwood and knots) as described in detail in Pinto et al. (2003, 2004). Figure 3 exemplifies the 3D representations for one maritime pine stem and one bucked log.

For this study the 35 maritime pine reconstructed stems were cross-cut with the bucking module of WoodCIM® at a 2.6 m length into a total of 218 logs. In the description of the external shape the reconstruction gives as output 24 radial vectors per each cross-section of the log with a between cross-section distance of 50 mm. The diameter was calculated with the average of all vectors that define each cross-section. The log volume was calculated by the sum of volumes of successive 50 mm sections. Tree and log characteristics are described in Table 1.

To compare the sawing simulation with the industrial results, a sample of 29 logs was chosen, from the 218 virtual logs pool, based on equivalent butt and top diameters. Figure 4 displays the diameters of the real and virtual logs.

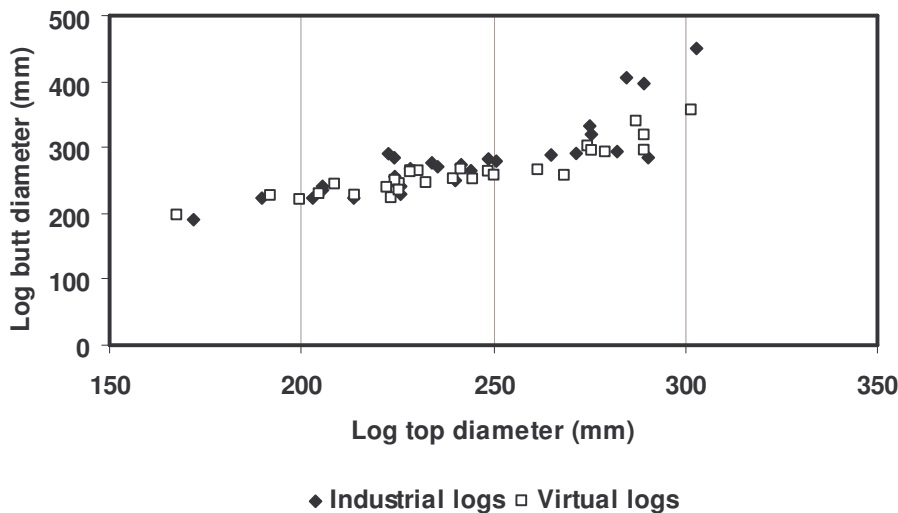

Figure 4: Log top and butt diameters for the industrial logs and the selected virtual logs

2.2.2 Sawing simulation

The sawing simulation software of WoodCIM® was used to predict the production output of boards and lumber. The programme uses different sawing set-up options for each log and chooses the best combination of sawing pattern, dimensions and qualities of the sawn timber products. The input variables are the nominal and green dimensions of sawn timber products, the quality requirements for each face, prices of sawn timber products and of co-products and saw kerfs. The software was adapted for maritime pine, *i.e.* in the input data the number of sawing patterns was increased to 100 and the number of widths allowed to each sawn product was increased from 5 to 35. The sawing method is live-sawing with fixed rotation position of the log in which is maintained in the different sawing simulations of the log.

The output gives the best set-up and sawing pattern, the number of sawn timber products by dimension and grade and the volume and value yield of sawn timber products for the entire batch of logs, for the logs of one stem, for individual logs and for a specified log sample.

For this study, the input data for the simulations concerning product dimensions, sawkerf and sawing patterns was equivalent to those used in the industrial test (Figure 2,). No wane edge was allowed in any sawing product. Only green dimensions were used and green sawing yields were obtained, as in the industrial tests. The simulation program was run to make volume optimisation by setting equal quality and prices to all products.

For the simulation of board sawing the software was modified to edge each individual board with the maximum width as it was done in the industrial edging operation (Figure 2). For sawing lumber and boards, 40 different sawing patterns were given as input with the lumber pieces taken from the central part of the log and boards from the sides. For this simulation, board width and thickness were inputted in cross fields so the industrial pattern could be reproduced (Figure 2b).

3 RESULTS

3.1 Single sawing pattern: boards

The batch yield for the simulated sawing of the 20 virtual logs for production of boards was similar to the industrial yield (Table 2). However, the yields obtained in the sawmill for individual logs showed a larger range of variation, from 36% to 76% in the industrial test and from 45% to 64% in the virtual sawing. Figure 5 registers the spreading of individual log yields by log top diameter. For smaller logs industrial yield is in general higher than the simulated one. However, for bigger logs the highest absolute differences occur when the sawing simulated yield was higher than the industrial one.

In the pool of virtual logs, the number of logs with butt and top diameters matching those of the industrial logs was 89. A simulation run with these logs resulted into yields similar to those obtained with the 20 log samples: batch yield 54% ranging for individual logs from 38% to 65%.

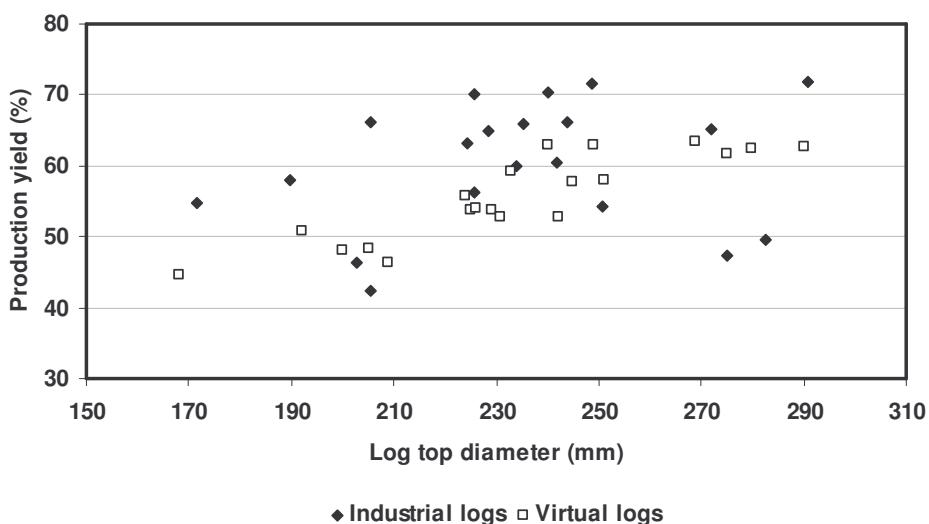

Fig 5: Sawing yields for the industrial and virtual logs

Table 2: Industrial and simulated sawing outputs

	<i>Industrial Logs</i>	<i>Virtual Logs</i>
<i>Sawing for boards</i>		
Number	20	20
Butt diameter (mm)	190 - 454	200-307
Top diameter (mm)	172 - 303	168-290
Taper (mm/m)	0.2-22	3.9-23.5
Minimum yield (%)	35.7	44.6
Maximum yield (%)	76	63.5
<i>Batch yield (%)</i>	<i>56.8</i>	<i>56.6</i>
<i>Sawing for lumber and boards</i>		
Number	3	3
Butt diameter (mm)	224-289	229-268
Top diameter (mm)	214-265	214-266
Taper (mm/m)	9-17.8	2.8-5.4
Minimum yield (%)	43	47.3
Maximum yield (%)	47	58.7
<i>Batch yield (%)</i>	<i>44.7</i>	<i>52.7</i>
<i>Sawing resin tapped logs</i>		
Number	6	6
Butt diameter (mm)	285-454	243-362
Top diameter (mm)	223-303	223-302
Taper (mm/m)	0.4-24.7	4.2-23.5
Minimum yield (%)	32.8	52.4
Maximum yield (%)	61.5	58.9
<i>Batch yield (%)</i>	<i>44.1</i>	<i>55.1</i>

The variation of batch sawing yield with the number of logs included in the sample is shown in Figure 6 for the industrial test and the simulation, where the number of logs in the sample is increased randomly by one log. The yields were very variable for a batch with a small number of logs but from 10 logs up the yields appeared to stabilize and showed similar variation for simulation and industrial test. When 18 or more logs were included in the sawing batch, the industrial and simulated yields became very close.

Figure 7 shows the width distribution of the sawn boards. A large range was obtained with the highest frequency for widths between 190 and 210 mm, respectively 21 and 27% for the virtual and industrial cases. Some differences were observed between simulation and industrial run, with more boards with larger widths for the simulated sawing: 64% of the boards obtained with the sawing simulation of the 20 virtual logs had widths between 190 and 270 mm, while the corresponding proportion was only 46% in the industrial sawing.

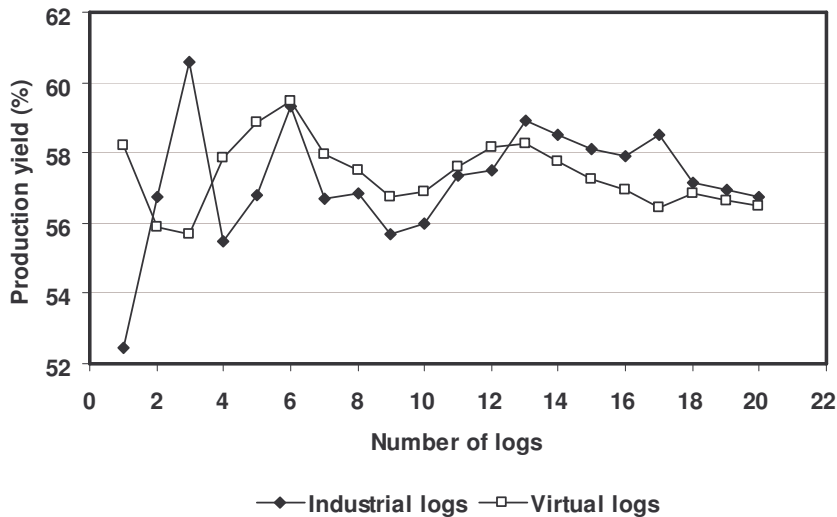

Figure 6: Variation of batch yields with the number of logs for the industrial and the simulated sawing

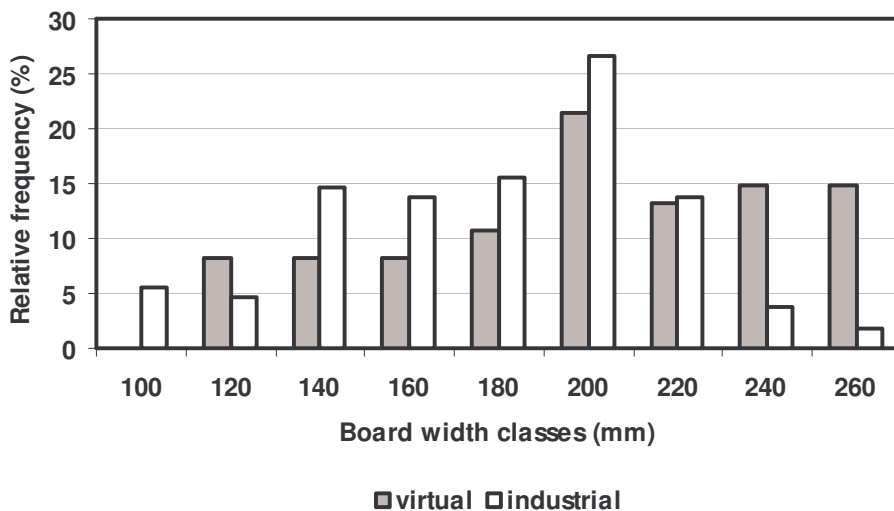

Figure 7: Distribution of board width obtained in the industrial and in the simulated sawing. Classes' 20 mm wide, central value displayed in x axe.

3.2 Mixed sawing pattern: lumber and boards

The sawing simulation for production of lumber and boards showed a yield 8% above the industrial yield (Table 2). When the simulation was done with all butt and top diameter matching logs from the virtual log pool, totalling 40 logs, the batch yield was 53% and individual log yield ranged from 40 to 65%.

The output for the sawing of the 3 logs batch show that the sawn products included 64% of the total volume as lumber products in the sawing simulation and 48% in the industrial sawing. More and larger lumber pieces were obtained in the virtual simulation: 9 pieces (0.13 m³) and 7 pieces (0.08 m³), respectively for simulation and industrial output. The number and volume of sawn boards was similar in both cases: 9 boards with 0.08 m³ in the industrial test and 8 boards with 0.07 m³ in the virtual sawing.

3.3 Effect of resin tapping in sawing yields

It was possible to analyse the effect of resin tapping on the sawing yields (Table 2) by comparing the yields obtained in the industrial sawing of resin tapped logs with the yields obtained by simulation of the sawing of a similar sample of logs (as the control, resin untapped logs). There was a difference with the industrial yields of the resin tapped logs lower by 11% in relation to the simulated control.

The differences between the yields of resin tapped logs and of the virtual equivalents increased with log size (Figure 8). For the smaller logs (top diameters 220-230 mm) the yields were similar and resin tapping did not seem to decrease the industrial yield. For the larger logs the loss in production yield due to resin tapping could go up to 18%.

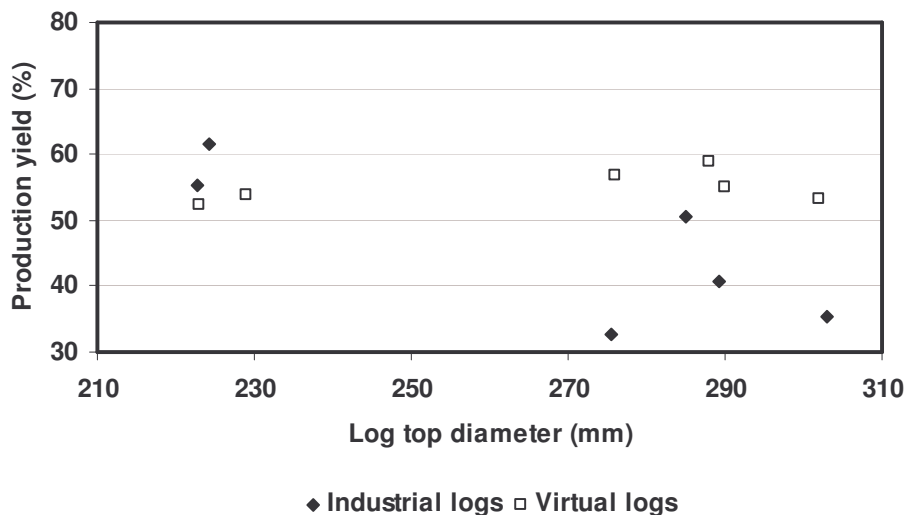

Figure 8: Yields obtained in the industrial sawing of resin tapped logs and in the sawing simulation of corresponding virtual logs

3 DISCUSSION

The results obtained with the sawing simulation of virtual logs showed the same yields as those obtained with the industrial sawing of a comparable match of logs for the production of boards (57%) and a higher yield for the production of lumber pieces and boards (45% vs. 53%) (Table 2). Overall the yield obtained with the mixed sawing pattern for lumber and boards was under the yield obtained with the single sawing pattern. The same influence of the sawing pattern on yields was reported by Richards (1973) who simulated the sawing of logs (as truncated cones) using different sawing patterns and found that the mixed sawing pattern resulted into lower yields.

However some considerations must be made in relation to the accuracy of the results. One obvious concern is the dimensioning of the sample, e.g. the number of logs, to estimate the batch yield, since individual logs show a large variation of sawing yields both in reality as in the sawing simulation of virtual logs (Table 2). The variation of batch yield with the number of logs (Figure 6) showed that for a small number of logs, the yields were highly variable but rather stabilized for samples containing more than 10 logs. The behaviour of industrial results and simulation outputs was found very similar for samples sizes of 6 or more logs.

The results regarding the production of boards, where 20 logs were tested, seem therefore to be robust. A calculation using all the virtual logs in the pool that matched the industrially sawn logs, totalling 89 logs, showed a very similar batch yield (54% vs. 57%) and range of variation for individual logs. Usenius (1980) found a difference of 0.3% by comparing industrial and simulated sawing yields concerning 25 mm thick sideboards received in the cant sawing for sawn volume corresponding to a one year production at a Finnish sawmill. Maritime pine is a very resinous conifer and resin tapping was done extensively in Portugal, by wounding the lower part of the stem and stimulating the exudation of resin with acid. The butt log of resin tapped pines shows therefore scars on the external part of the stem. Although resin production is decreasing in Portugal for economic reasons (i.e. labour costs) many of the pine trees available for the industry have been tapped and are a concern for the sawmill. It is generally accepted that sawing yields will be lower in the case of resin tapped logs but calculations of the potential yield loss caused by resin production have not been made.

In the industrial test six of the 29 trees were resin tapped. By comparing the sawing yields of these logs with the simulation done on their virtual matched logs, it was possible to estimate the impact of resin tapping as a loss of 11% on the sawing yields (44% vs. 55%, Table 2). This loss was higher in the larger logs as these normally suffer the more severe tapping. The stem area affected by the resin tapping is in most of the logs outside the knot core zone, and although this issue was not explored here, one should expect a even higher value yield loss as this waste zone corresponds to the best board grades.

The comparison between industrial and virtual environments should also be analysed in view of the factors that can influence sawing yields. One aspect of variation is the fact that the logs used for both situations were not the same even if the sample selected as input for the sawing simulation from the virtual logs pool was carefully chosen to match as much as possible the industrially tested logs (Figure 4).

The calculation of log volume also influences on the sawing yield. The volume calculated for the virtual logs was more accurate than for the industrial logs since it was based on the sum of volumes calculated every 50 mm along the log length, while in the sawmill it was based only in butt and top diameters

In an industrial environment the factors influencing the production yield are various and random between the sawing of two logs with human operational decisions, errors along the sawing line and in measuring that affect the sawing yields. These facts are not taken into account in the sawing simulations where the calculation procedures are exactly the same for all the logs. Also, though the virtual logs used as raw material for the sawing simulation had proven to be close representations of the real ones (Pinto et al., 2003, 2004) they still were models less complex than the reality. Therefore, the dispersion of the sawing yields for the industrial logs was much higher than for the simulated ones, as there are more random effects for each log in the first case (Figure 5).

Moreover, in the industrial environment, the sawyer optimises easier the sawing for smaller logs than for larger ones while for the simulation program this is not an issue. For the larger logs higher yields were obtained in the simulation compared with the similar diameter range of the industrial sawing (Figure 5). The fact that the highest frequency of board width is between widths of 190 and 210mm in both industrial and virtual sawing showed that the majority of the logs were sawn in a similar way.

However in the industrial sawing the log was rotated by the sawyer to the best position while the simulation programme always sawed the log in the same position. Previous studies in sawing simulation of Scots pine (*Pinus sylvestris* L.) have shown that differences in yield between the worst and the best rotation angle were in average 6%, decreasing with log top diameter (Usenius et al. 1989).

The WoodCIM® virtual sawing module is able to account with other factors such as the quality of the sawing products *i.e.* knots. These features were not measured in the industrial test and therefore value optimisation could not be carried out here but the potentialities of the sawing simulation module of WoodCIM® to study the conversion chain for maritime pine were explored in Pinto et al (2002). The software allowed the new adaptations to this species and was flexible concerning the input of products and process requirements.

In resume, though further studies will be necessary to further validation, the sawing simulation module was able to reproduce the industrial sawing of maritime pine logs. The pool of 35 virtual maritime pine stems could generate a good quantity of logs with dimensions in the range of the industrial raw-material supply (129 out of 218). The stem/log mathematical reconstruction and the sawing simulation modules were useful tools to develop various sawing studies for this species, to evaluate the impact of raw material and process characteristics on the production performance, and to support the development of tools for industrial application.

4 REFERENCES

- Björklund L** (1999) Identifying heartwood-rich stands or stems of *Pinus sylvestris* by using inventory data. *Silva Fenn.* 33 (2): 119-129.
- Chiorescu S, Grönlund A** (2000) Validation of a CT-based simulator against a sawmill yield. *Forest Prod. J* 50(6): 69-76
- Grundberg S** (1999) An X-ray LogScanner - a tool for control of the sawmill process. Division of Wood Technology, Luleå University of Technology, Doctoral thesis, Skellefteå (1999) 30 pp.
- Hallock H, Stern AR, Lewis DW** (1978) Is there a "best" sawing method?. *Res. Pap. FPL-280.* USDA Forest Serv., Forest Prod. Lab. 11 pp.
- Ikonen V-P, Kellomäki S, Peltola H** (2003) Linking tree stem properties of Scots pine (*Pinus sylvestris* L.) to sawn timber properties through simulated sawing. *For. Ecol. Manage.* 174, 251-263.
- Knopic S, Gloria A, Pereira H** (2004) Analysis of production yields in the sawmill industry. *Anais Inst. Sup. Agronomia*, in press (*In Portuguese*)
- Leban JM, Duchanois G.** (1990) SIMQUA: A simulation software for wood quality. *Ann. Sci. For.*(47):483-493.
- Maness TC, Lin Y** (1995) The influence of sawkerf and target size reductions on sawmill revenue and volume recovery. *Forest Prod. J.* 45(11/12):43-50
- Oja J** (1997) Measuring knots and resin pockets in CT-images of Norway spruce. Division of Wood Technology, University of Technology, Luleå, Licenciante thesis, Skellefteå (1997) 6 pp.
- Pinto I, Pereira H, Usenius A** (2002) Sawing simulation of *Pinus pinaster* Ait. *in Proc. of 4th workshop in "Connection between Silviculture and wood quality through modelling approaches and simulation softwares".* British Columbia. Ed. G. Nepveu, INRA, Nancy
- Pinto I, Pereira H, Usenius A** (2003) Analysis of log shape and internal knots in twenty maritime pine (*Pinus pinaster* Ait.) stems based on visual scanning and computer aided reconstruction. *Ann. For. Sci.* 60: 137 - 144
- Pinto I, Pereira H, Usenius A** (2004) Heartwood and Sapwood development in maritime pine (*Pinus pinaster* Ait) stems. *Trees*, *in press* (online:10.1007/s00468-003-0305-8)

- Pinto I, Usenius A, Song T, Pereira H (200_) Sawing simulation of maritime pine (*Pinus pinaster* Ait.) stems for production of heartwood containing components. Accepted to Forest Prod. J.
- Richards** DB (1973) Hardwood lumber yield by various simulated sawing methods. Forest Prod. J. 23(10):50-58
- Schmoldt** D, Li P, Araman P (1996) Interactive simulation of hardwood log veneer slicing using CT images. Forest Prod. J. 46(4):41-47.
- Song** T (1987) Optimization of sawing decision making through computer simulation. Laboratory of mechanical wood technology, Helsinki University of Technology, Licentiate thesis, Espoo, pp 109
- Song** T (1998) Tree stem construction model for "Improved spruce timber utilisation" project. VTTs Building Technology internal report. Helsinki pp 20
- Todoroki** CL (1994) Effect of edging and docking methods on volume and grade recoveries in the simulated production of flitches. Ann. Sci. For. 51, 241-248
- Todoroki** CL (1996) Developments of the sawing simulation software AUTOSAW - linking wood properties, sawing and lumber end-use. In: Proc. of the 2nd Workshop on Connection Between Silviculture and Wood Quality through Modelling Approaches and Simulation Softwares, South Africa, Ed. G. Nepveu, INRA, Nancy, pp 241-247
- Usenius** A. (1980) Model for simulation of sawing setup. Doctoral thesis, VTT, Technical centre of Finland pp 178 (*in Finnish*)
- Usenius** A (1999) Wood conversion chain optimisation. in: Proc. of 3rd workshop on Connection between Silviculture and Wood Quality through Modelling Approaches and Simulation Softwares. La Londe-Les-Maures. Ed. G. Nepveu, INRA, Nancy, pp 542-548.
- Usenius** A (2000) WoodCIM® - Integrated planning and optimizing system for sawmilling industry. VTTs Building Technology internal report. 8 pp
- Usenius** A, K.O. Somnardahl KO, Song T (1989) Project in optimal use of wood raw material. Final internal report, VTT, Technical Centre of Finland pp 209 (*in Finnish*)

Sawing simulation of maritime pine (*Pinus pinaster* Ait.) stems for production of heartwood containing components

ISABEL PINTO^{a(*)}, ARTO USENIUS^b, TIECHENG SONG^c, HELENA PEREIRA^d,

^a (*) Visiting researcher

VTT Building and Transport, P.O. Box 1806, FIN-02044 VTT, Finland
Tel. +358 9 456 5565, fax +358 9 456 7027, email isabel.pinto@vtt.fi

^b Research Professor

VTT Building and Transport, P.O. Box 1806, FIN-02044 VTT, Finland
Tel. +358 9 456 5540, fax +358 9 456 7027, email arto.usenius@vtt.fi

^c Researcher

VTT Building and Transport, P.O. Box 1806, FIN-02044 VTT, Finland
Tel. +358 9 456 5540, fax +358 9 456 7027, email tiecheng.song@vtt.fi

^d Professor

Centro de Estudos Florestais, Instituto Superior de Agronomia, 1349-017 Lisboa, Portugal
Tel. +351.21.3634662, fax +351.21.3645000, email hpereira@isa.utl.pt

Acknowledgments

Financial support was provided for the first author by a scholarship from Fundação para a Ciência e Tecnologia (Portugal) and by a Marie Curie Research Training Grant within the EU 4th RTD Framework programme. Part of the work was carried out under the research programme PAMAF 8185, financed by INIA (Instituto Nacional de Investigação Agrária, Portugal). Thanks are due to the Portuguese National Forest Service (Direcção Regional Agrária da Beira Litoral) and to SONAE Indústria and AJI Serração, who supplied the trees.

Abstract

Natural durable heartwood products have less dimensional changes and are an environmentally friendly alternative to the use of preservatives. The present study explores the potential for the production of products containing heartwood from maritime pine (*Pinus pinaster* Ait.). The study was based on 30 virtual maritime pine stems that were mathematically reconstructed including description of external shape, internal knot architecture and heartwood. Stems were used as raw material input data for simulation of bucking and sawing. The impact of raw material characteristics and final products requirements on sawing yields was studied for production of components for glued laminated boards and for windows. Log and heartwood diameters were found to be the most influencing variables on final yields. The position of the log within the stem was also important while log length did not influence final yields (around 5% batch yield for all length groups). The highest sawing yields, 13% of heartwood products from log total volume, were found with 3 m logs bucked between 3 and 9 m height of 83 yr old trees. There is potential for the production of maritime pine heartwood products with additional efforts to be done in log and product sorting.

1 INTRODUCTION

Most tree species show two distinct zones in the xylem: the outer sapwood and the inner heartwood. The formation of heartwood results from the natural ageing of the tree, and varies with species, genetics and growth conditions. Reviews can be found at Taylor et al. (2002), Hillis (1987) and Bamber and Fukazawa (1985). Heartwood and sapwood have different color, density, moisture content, chemical composition, mechanical and technical properties such as natural durability and suitability for chemical treatments. The content of sapwood and heartwood has therefore a significant impact on the utilization of wood. In pulping, the heartwood extractives affect negatively the process and product properties. For solid wood applications the different properties of heartwood and sapwood influence several unit operations, i.e. drying, adhesion to glues and paints, and issues such as aesthetic values for the consumer and ecological concerns, since the natural durable heartwood products offer an environmentally friendly alternative to preservatives. When there is a large color difference between sapwood and heartwood, selection of wood components by color also plays a significant role in some timber applications.

Some heartwood products are already successfully commercialized (e.g. floors and windows) and industrial interest is growing. The possibility of applying techniques to reduce defects and material heterogeneity i.e. finger joint, increases their competitiveness in relation to substitute materials.

The number of studies on the potential of heartwood-targeted products is very limited. Toverød et al. (2003) simulated the sawing of Scots pine (*Pinus sylvestris* L.) trees in order to optimize sawing patterns in function of heartwood products yields.

Within the wood conversion chain, sawing simulation tools have been developed to optimise production, linking raw material properties to industrial production planning (Usenius 1999, Schmoldt et al. 1996, Todoroki 1996, Leban and Duchanois 1990, Hallock et al. 1978). The impact of specific conversion variables and scenarios on sawing yields

was analysed using the virtual sawing of logs and trees (Ikonen et al. 2003, Pinto et al. 2002, Maness and Lin 1995, Todoroki 1994, Richards 1973). Simulation techniques may be applied to the heartwood component of stems, and this was done for maritime pine (*Pinus pinaster* Ait.), a species with a strong reddish-brown heartwood in contrast with the pale yellow sapwood (Pinto et al. 2004). Maritime pine is an important softwood species in Southern Europe, with 3 million ha in Portugal, Spain and France, directed to the pulp, board and saw milling industries.

The virtual representation of maritime pine stems including internal knottiness (Pinto et al. 2003) and heartwood (Pinto et al. 2004) has already been done using three-dimensional reconstruction algorithms (Usenius 1999, Song 1998) and applied for sawing yield simulation studies (Pinto et al. 2002). The heartwood represents 17% and 12-13% of stem volume, up to 50% of tree height, respectively in 83 and 42-55 year old trees.

The objectives in the present study were to analyze the potential of Maritime pine stems for production of heartwood products, and to evaluate raw material and product variables that can influence it, by using sawing simulation tools for two product families: components for glued laminated boards and for window frames.

2. MATERIAL AND METHODS

Sawing yields in heartwood products were calculated using the bucking and sawing simulation modules of WoodCIM® after adaptation for maritime pine (*Pinus pinaster* Ait.) (Pinto et al. 2002). WoodCIM® is an integrated optimizing software system developed at VTT - Technical Research Centre of Finland (Usenius 1999, 2000) for the wood conversion chain. Virtual reconstructed stems were developed for maritime pine representing the external shape, internal knots and heartwood (Pinto et al. 2003, Pinto et al. 2004). The input data were supplied by the industry for two product families: components for glued laminated boards and windows.

2.1 Input data of raw material for sawing simulation

Thirty maritime pine trees were randomly sampled from three stands in Portugal: 20 from Leiria (LE), 5 from Alpiarça (AL) and 5 from Marco de Canaveses (MC). Data concerning site, stand and tree biometry were detailed in Pinto et al. 2004. In Leiria, the trees were 83 year old and had an average diameter at breast height (DBH) of 47.8 cm. In the other sites, trees aged between 42 and 55 years with average DBH of 38.9 and 42.7 cm. The heartwood volume contents (from 0 to 50% of tree height) were, in average, 15, 11 and 12%, respectively for LE, AL and MC sites. The trees were mathematically reconstructed into a set of virtual 3D stems using the so-called flitch method, where the data concerning the geometrical and quality features (i.e. heartwood and knots) were obtained by computing scanned images of flitches (Usenius 1999, Song 1987,1998). The virtual representation of the maritime pine stems has been described in Pinto et al. (2003, 2004). Figure 1 exemplifies the 3D and 2D representations for one maritime pine log showing external shape, internal knot architecture and heartwood.

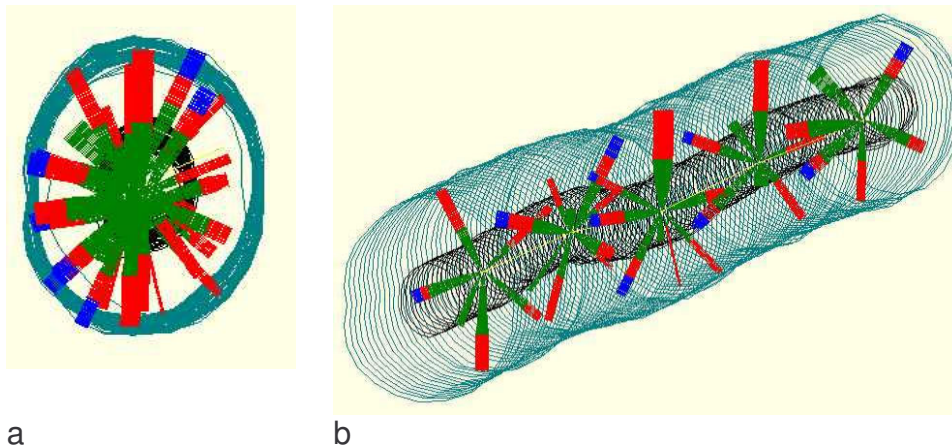

Figure 1: Representation of one maritime pine log showing in two (a) and three dimensions (b), the geometry of the log, the internal knot architecture and the heartwood part

2.2 Bucking and sawing simulation

The virtual reconstructed models of stems were used to predict the sawing yield using the bucking and sawing modules of the WoodCIM® software. Small adaptations were done to the program due to the larger stem diameters of maritime pine when compared to Scots pine and spruce, for which the bucking module was initially developed, i.e. screen stem size was re-scaled and the number of log lengths was increased from 7 to 10.

The sawing module can be applied using as input the virtual stem as well as only the heartwood part extracted from the stem, because heartwood was reconstructed with the same algorithms as used for the stem shape (Pinto et al. 2004). Therefore, heartwood can be virtually sawn separately from the stem thereby allowing the calculation of a sawing yield for heartwood products. By adapting different wane specifications it is possible to saw components with at least one heartwood face, the remaining volume being within the sapwood (Figure 2). The heartwood containing products are referred to as heartwood products.

The program calculated the sawing yield by using different sawing set-ups for each log and choosing the best combination of sawing pattern, dimensions and qualities of the sawn timber products. The nominal and green dimensions of sawn timber products, the quality requirements for each face, prices of sawn timber products and of by-products and saw kerfs were introduced as input variables. The simulation software module was also adapted for maritime pine (Pinto et al. 2002). The output gives the best set-up and sawing pattern, the number of sawn timber products by dimension and grade and the volume and value yield of sawn timber products. The results were obtained for the entire batch of logs, for individual logs and for a specified log group.

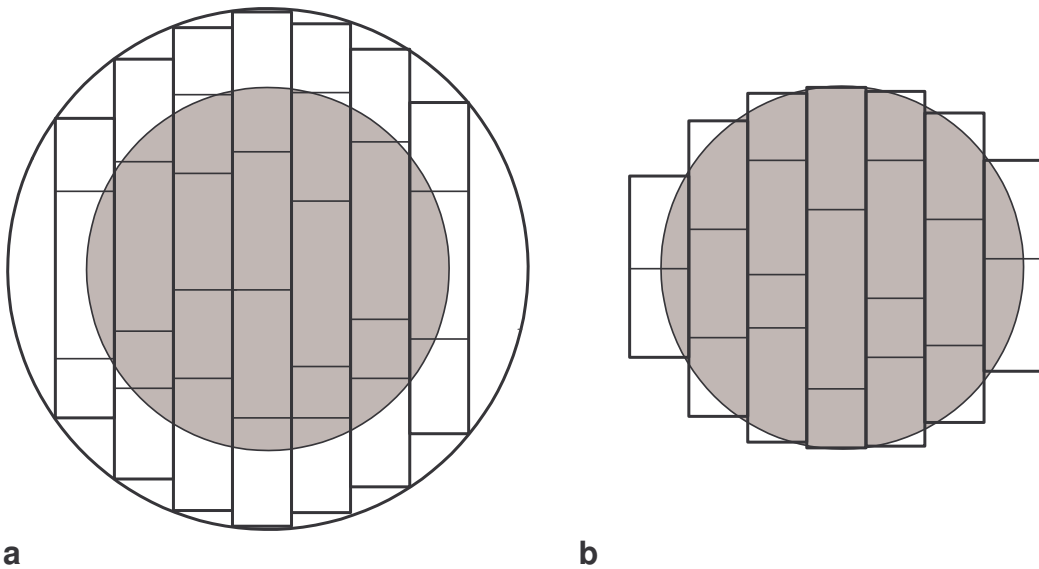

Figure 2: Schematic representation of the sawing simulation of whole log (a) and heartwood part (b)

2.3 Sawing set-ups and data analysis

2.3.1 Raw material and sawing process

The 30 virtual stems were bucked into four different log lengths: 2, 3, 4 and 5 m. The logs were grouped by top diameter into nine classes with 50 mm amplitude. The live sawing module was used to cut the logs into boards with the specified thickness and further to optimize the board cutting into the required components. The log was not allowed to rotate between simulations. The simulations were run for the log as well as for the heartwood. The yields obtained refer to total product yield from the log (Y), and to yield of heartwood products calculated in relation to log (Y_{log}) and heartwood (Y_{htw}) volumes. Table 1 describes the yield variables obtained with the sawing simulation and the log and heartwood characteristics.

2.3.2 End-product specifications

Two types of products were considered: components for glued laminated boards and components for windows. The dimensional and quality requirements of both components are given in Table 2. For heartwood components, wane was allowed in 95% of the thickness and in 100% of the width and length. Equal price was set for all products as the target in the present study was to obtain volume sawing yields.

All the logs were virtually sawn using the specifications for glued laminated boards and the results were analyzed in relation to the impact of raw material characteristics on the sawing yields. To study the influence of end-product requirements on sawing yields, simulations were run for the production of window components using a homogeneous sub-sample from stand LE of 30 logs, with 3 m length, and located between 3 and 9 m of stem height.

Table 1: Description and notation of yields and log ($_log$) and heartwood ($_htw$) variables

Variable	Notation	Description
Total Yield for log volume	Y	(Products volume/log volume) x 100(%)
Yield of heartwood products for log volume	Ylog	(Volume of Heartwood containing Products/log volume) x 100, (%)
Yield of heartwood products for heartwood volume	Yhtw	(Volume of Heartwood containing Products/heartwood volume) x 100 (%)
Top diameter	DTlog,DThtw	Average of 24 vectors that define the top cross-section (mm)
Butt diameter	DBlog, DBhtw	Average of 24 vectors that define the butt cross-section (mm)
Taper	Tlog, Thtw	Slope of the line marking the external limit of diameters determined every 50 mm of length (mm/m)
Pith curviness	C	Maximum deviation (in any direction) of pith, found along the log, in relation to an imaginary axis defined by a straight line connecting the pith points at butt and top end of the log (mm/m)
Position	P	Position in stem height of the log butt (m)

Table 2. Dimensions and quality requirements for the heartwood components specified in the sawing simulation

Components	Dimensions (mm)	Quality
Glued laminated boards	thickness: 18/25, 22/29 and 25/32 (final/green) width: 60 and 55 length: 950, 110, 1200, 1300, 1450, 1600, 1800, 2100, 2020, 2440	No restrictions on defects
Windows	thickness: 22/29 (final/green) width: 75, 100, 125 and 150 length: 400, 600, 800, 1000, 1200,1400,2000	Gade (*),*number of faces with knots allowed

3 RESULTS

3.1 Influence of raw material characteristics

The sawing of components for glued laminated boards was simulated for four bucking lengths. The results are summarized on Table 3 by log diameter classes. Regardless of log length about 65% of the bucked logs had a top diameter between 225 and 375 mm. Heartwood volume proportion within the log varied from 5 to 28%. Logs without enough heartwood volume to be sawn into the required components (0% yield) occurred in variable number for all diameter classes below 350 mm. For all length groups no log was sawn with top diameter below 125 mm and in diameter class of 150 mm only 20% of the sawn logs yielded heartwood products.

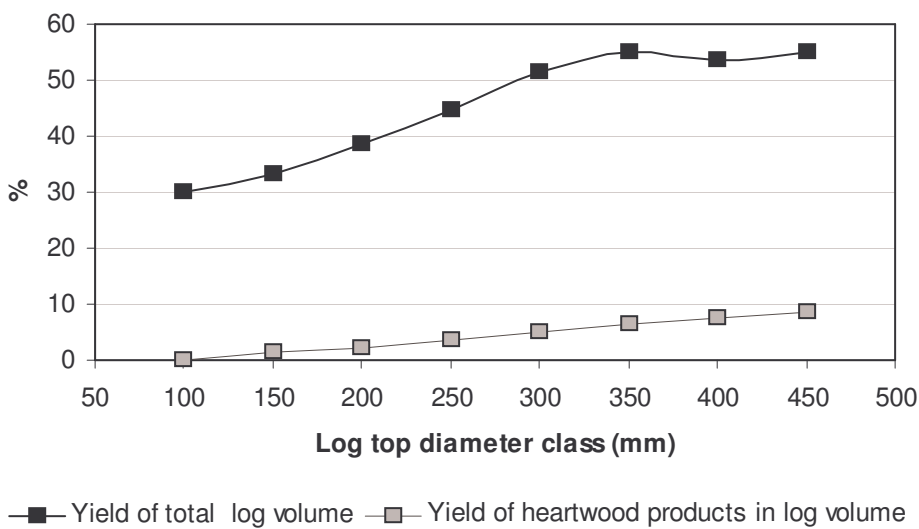

Figure 3. Sawing yields (of the total and of the heartwood volume) of components for glued laminated boards in % of log volume by log diameter class for 3 m long logs

Sawing yields increased with diameter for all log lengths, with the highest yields for classes 350 to 500 mm (Table 3). Figure 3 shows the sawing yields by log diameter class for 3 m long logs. Total yield of log sawing (Y) increased rapidly from around 30% for class 100 logs to 55% for class 350 logs, by adding approximately 5% yield per diameter class and kept rather constant in the following log classes. The yield of heartwood products (Ylog) also increased with the diameter class almost in a linear way. The difference between two neighboring classes was about 1%. The range of sawing yields of individual logs was large for all log diameter classes and lengths and several outliers were registered.

The influence of log and heartwood variables on the sawing yields was studied through correlation analysis (Table 4). Since heartwood content varies with tree age, the analysis was also carried out for the trees classified in two different age groups (80 and 42-55 years). Yield of heartwood products (Ylog) was highly correlated with heartwood variables (heartwood top diameter, proportion and volume) and with log top diameter. A negative

correlation of log position in the stem with yield was also significant, though with lower correlation factors. Weak correlations were found with curviness and heartwood taper and none with log length and log taper.

Table 3: Simulation output for the sawing of heartwood components for glued laminated boards. Logs bucked to different lengths

Log length m	Diameter class mm ⁽¹⁾	Number of logs	0 yield logs	Heartwood in log (%) min. - max.	Yhtw		Ylog	
					%	sem ⁽²⁾	%	sem ⁽²⁾
2	100	2	2	5.0-9.4	0	0	0	0
	150	10	9	4.3-17.0	11.9	0	2.1	0
	200	42	35	3.0-22.4	15.9	3.2	2.3	0.6
	250	60	19	5.8-24.8	23.3	1.6	3.4	0.4
	300	61	9	2.9-27.9	29.9	1.2	5.0	0.3
	350	54	0	8.7-26.3	35.9	1.0	6.1	0.3
	400	30	0	8.4-26.8	39.7	1.3	6.8	0.5
	450	7	0	11.8-22.9	41.9	1.6	7.5	0.8
500	4	0	15.8-24.3	45.6	1.5	8.7	0.5	
3	100	1	1	7.3-15.5	0	0	0	0
	150	6	5	5.4-15.9	8.33	0	1.4	0
	200	24	19	4.1-21.3	14.3	5.7	2.1	0.5
	250	38	8	3.3-25.9	24.1	1.5	3.5	0.3
	300	41	2	4.2-27.7	30.8	1.4	5.0	0.4
	350	33	0	9.4-26.2	38.8	1.3	6.5	0.4
	400	18	0	8.4-26.6	42.2	1.8	7.4	0.6
	450	5	0	12.4-23.3	45.7	2.7	8.4	1.5
500	2	0	16.1-19.8	48.9	2.6	8.7	0.4	
4	100	2	2	5.5-13.9	0	0	0	0
	150	5	4	6.0-15.8	6.7	0	0.8	0
	200	22	14	3.5-17.0	12.5	1.9	1.6	0.3
	250	29	7	5.3-26.4	22.6	1.7	3.6	0.4
	300	31	2	3.5-27.4	30.4	1.5	4.8	0.5
	350	23	0	11.4-26.3	37.1	1.5	6.5	0.5
	400	12	0	8.7-25.5	40.4	2.4	6.8	0.4
	450	4	0	12.9-23.3	43.9	1.2	8.8	1.1
500	1	0	16.8	51.2	0	8.6	0	
5	100	0	0	0	0	0	0	0
	150	6	5	5.7-15.8	5.3	0	0.6	0
	200	14	6	3.7-17.7	10.6	1.9	1.4	0.3
	250	26	4	3.7-23.7	21.2	1.7	3.1	0.3
	300	22	1	4.2-28.6	27.4	1.8	4.2	0.5
	350	22	0	11.4-26.0	38.9	1.5	7.0	0.5
	400	8	0	9.3-25.7	40.4	3.5	7.1	1.2
	450	2	0	13.5-23.0	41.1	1.3	7.6	1.7
500	1	0	17.3	50.8	0	8.8	0	

(1) Central value of each class, amplitude is 50mm

(2) standard error of mean

Table 4. Results of correlation analysis of yield of heartwood products (Ylog) for glued laminated boards with several log and heartwood characteristics

	Total sample trees N=669	80 yr old trees N=475	42-55 yr old trees N=194
Heartwood top diameter	0.88**	0.87**	0.77**
Heartwood proportion	0.87**	0.92**	0.69**
Heartwood volume	0.75**	0.72**	0.70**
Log top diameter	0.73**	0.65**	0.68**
Log volume	0.54**	0.45**	0.51**
Log butt position in stem	-0.40**	-0.54**	-0.48*
Pith curviness	-0.21**	-0.13**	0.12
Heartwood taper	-0.19**	-0.25**	-0.12
Log taper	0.01	0.05	0.17*
Log length	0.01	0.01	-0.02

Pearson correlation, **correlation is significant at the 0,01 level (2-tailed),
*correlation is significant at the 0,05 level (2-tailed)

Influence of log length

The yield obtained by sawing heartwood components for glued laminated boards did not show significant differences with log length. Yields for all the logs (including 0% yield logs) were 4.8% and 5.4% of log volume respectively for 2 and 3 m logs, and 5.0% for 4 and 5 m logs. Impact of log length was higher for the lower log diameter class and for log diameters under 300 mm the yield clearly decreased with increasing log length.

Influence of log position

Figure 4 shows the distribution of Ylog with log position within the stem. In order to increase sample homogeneity only 3 m logs from LE trees were analyzed. The second and third log positions, i.e., logs in the stem zone between 3 to 9 m of height, showed the highest batch yields of heartwood components, 7 and 8% in log volume, respectively. The yield obtained with butt logs was similar (6% batch yield) but after 9 m height yield decreased rapidly to 2% for the log starting at 15 m height. These results followed closely the vertical distribution of heartwood volume proportion, i.e. higher heartwood volume content was found in the second and third logs representing 18% of the log volume.

Influence of log diameter

The yield of heartwood components increased with heartwood top diameter following a linear distribution ($R^2 = 77\%$), as shown on Figure 5a. Only logs with heartwood diameters over 100 mm could yield heartwood components in the sawing. The only exceptions were two logs with high curviness and very irregular heartwood shape, therefore considered as outliers and excluded from the analysis. The variability of yields was always large especially for heartwood diameters in the range of 100-175 mm,(Table 3). For logs with heartwood diameters over 175 mm batch yield was 8% and the variability of results was low (stdev 2.3%). Below a heartwood diameter of 100 mm, 52% of the logs had 0% yield while for the remaining logs the yield varied from 0.5 to 6%.

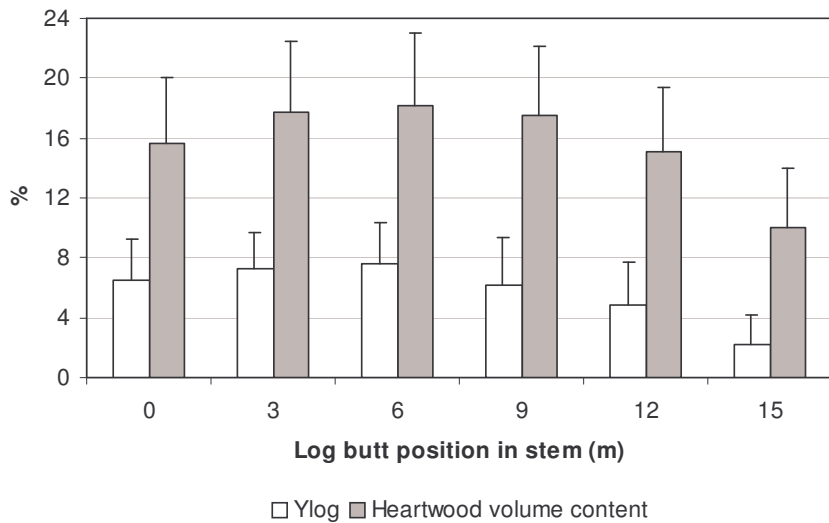

Figure 4. Yield of heartwood components (Ylog) for glued laminated boards and heartwood volume content, for logs in different positions along the stem. (Mean of 20 logs; error bars are sdev)

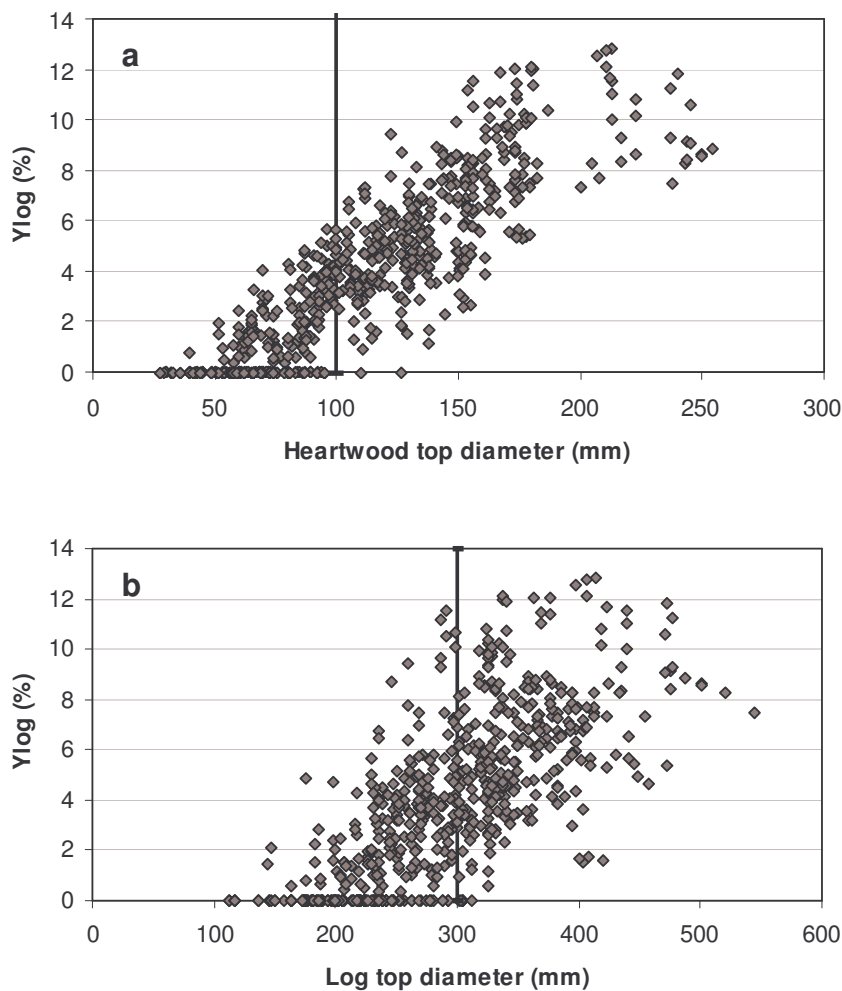

Figure 5: Yield of heartwood products for glued laminated boards as a function of heartwood top diameter (a, $R^2=77\%$) and log top diameter (b, $R^2=53\%$)

The yield obtained in function of log top diameter (Figure 5b) also showed an increasing trend but the variability was high. With log top diameters over 400 mm, the average yield of heartwood products was 8% (sdev 2.8%). Logs with top diameters over 300 mm allowed always production of heartwood components, while for 31% of the logs with top diameters between 200 and 300 mm the yield was 0%. However, even in this diameter range it was possible to obtain heartwood products with yields between 5 and 12% for 14% of the logs.

3.2. Prediction of sawing yields for heartwood products

Prediction of sawing yields in heartwood products was made through the fitting of models using log and heartwood variables. The best models are summarized in Table 5. Log top diameter allowed to predict 53% of the variation while addition of other log variables such as taper or curviness did not improve very much the prediction. Better predictions were obtained using the heartwood diameter as a variable (77% of the variation) and from addition of other variables did not result any improvement.

Table 5: Models to predict sawing yields of heartwood products for glued laminated boards in relation to log volume using log and heartwood variables

	Adjusted r2 (%)	Standard error of estimation	Selected models
1	53.0	2.24	$Y_{log} = 0.032 D_{log} - 5.4$
2	57.0	2.15	$Y_{log} = 0.031 D_{log} - 0.1 T_{log} - 0.1 P - 3.1$
3	76.7	1.58	$Y_{log} = 0.063 D_{htw} - 3.1$
4	76.8	1.58	$Y_{log} = 0.068 D_{htw} - 0.004 D_{log} - 2.6$
5	76.9	1.57	$Y_{log} = 0.065 D_{htw} + 0.039 P - 3.17$

3.3. Influence of product requirements

The impact of product requirements in heartwood sawing was studied for component products for windows. Raw-material was a sample of 30 logs with 3 m length (bucked between 3 to 9 m stem height) and top diameter between 268 and 476 mm. The yields obtained by the sawing of the total log volume and the yields of heartwood products with different quality specifications regarding the number of faces with knots, are summarized in Table 6. The batch yield with no restrictions on component quality (i.e. knots allowed in all faces) was 62% while the yield in heartwood products was 10% of the log volume.

The impact of increasing quality demand was higher in heartwood products (Y_{log}) than in total products (Y) (Table 6). For the log, yield increased about 8.8% from grade (0) to (4) while for the heartwood volume it increased only by 3.5%. The largest differences were obtained when the set-up conditions changed from no restrictions on quality [grade (4)] to restrictions in only one face [grade (3)], resulting into yield increases of 3% and 7% for Y_{htw} and Y , respectively.

Table 6: Total yield (Y) and yield in heartwood products (Ylog) in relation to log volume obtained for window components with different quality grades regarding the number of faces with knots

Grade	Y	Ylog
0	53.6	6.9
1	53.7	6.9
2	54.0	7.0
3	55.8	7.4
4	62.3	10.4

The distribution of heartwood components by length and width is shown in Fig. 6 for grades 0 and 4. The quality requirements had a major impact on the distribution of the sawn components dimensions. When no restrictions in quality were made, 40% of the sawing components had 3000 mm length and 17% had 400 mm length. There was a clear reduction on component dimensions when no knots were allowed in any component face. For this set-up 82% of the sawing components had 400 and 600 mm lengths while only 2.4 % had 2000 and 3000 mm lengths.

4 DISCUSSION

The mathematical reconstructed stems, including the internal knot architecture and the heartwood (Figure 1), provided a good tool for the virtual bucking and sawing simulations. The 3D reconstruction of maritime pine heartwood had been previously tested and showed a good accuracy (Pinto et al, 2004). The results obtained when sawing the total log volume (Y) (Figure 3), also agree with a previous sawing simulation study for this species (Pinto et al, 2002).

The WoodCIM® software was not designed to include heartwood as an input parameter or as quality feature in the output (Usenius 1999, 2000). Therefore, the heartwood was taken in the input as an individual entity, separated from the log, a sort of “heartwood log” (Pinto et al. 2003). The full utilization of the heartwood was possible by allowing wane in the products (Figure 2).

This sawing procedure is a virtual concept and in a real industrial situation, the process would be to saw the whole log and subsequently use the heartwood content of sawn products as grading criteria. This means that sapwood products would also be obtained and these have to be taken into account for an overall economic analysis. However the differences between simulation and industrial reality should not affect the analysis of the impact of the different variables in the sawing yield of heartwood products, which was the objective of this study.

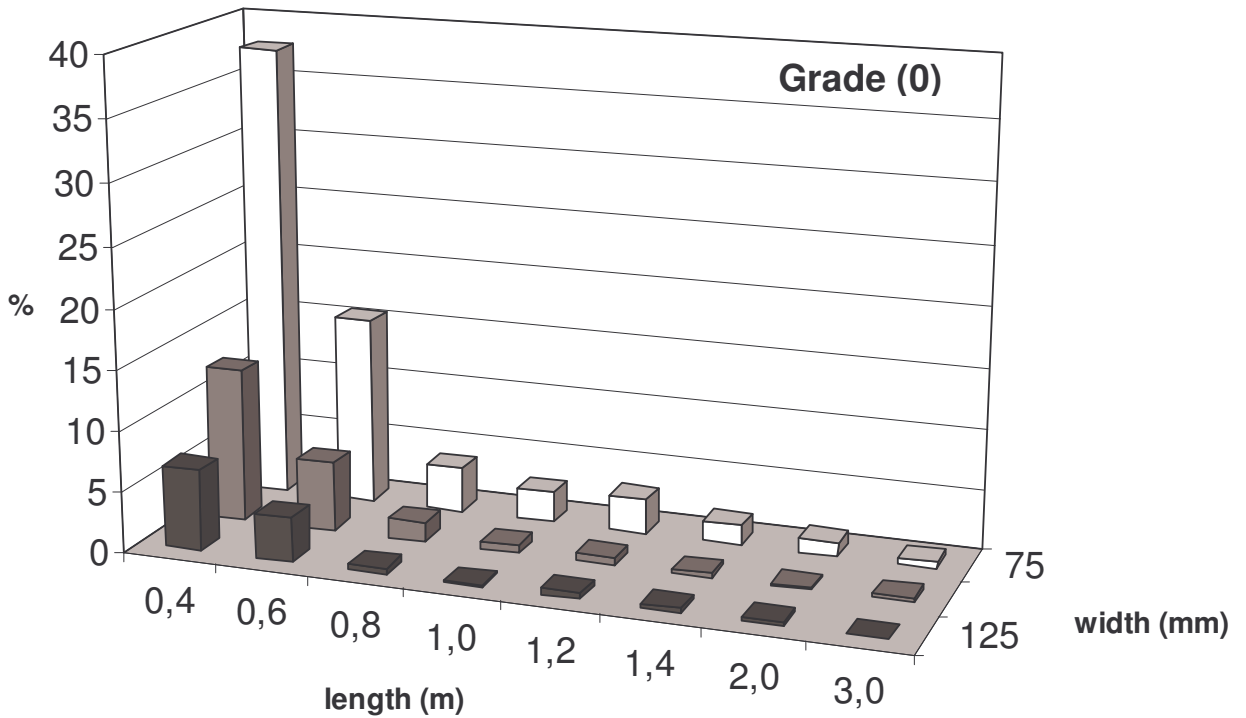
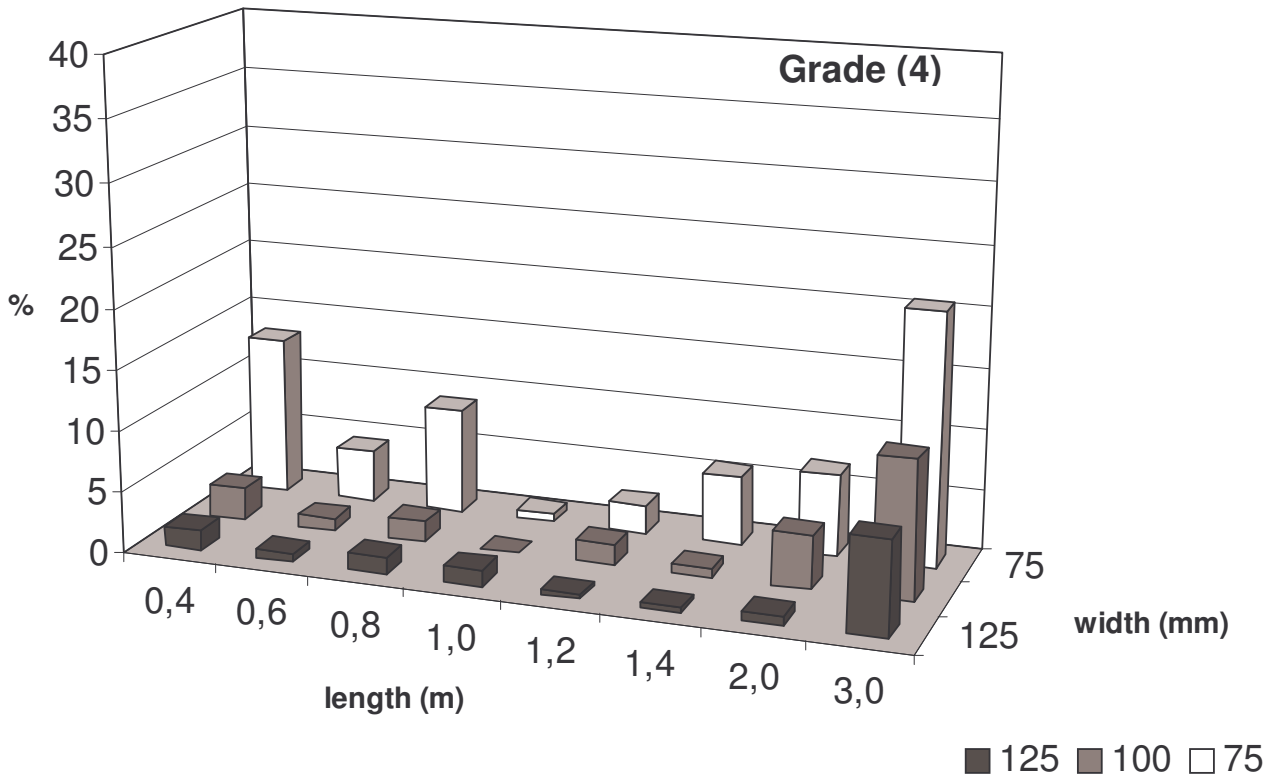

Figure 6: Frequency of dimensions of heartwood components (length and width) for sawing without any quality restrictions, concerning knots [grade (4)] and in the case knots were not allowed in the component's faces [grade (0)]

Windows and glued laminated boards were chosen as products due to the potential of increasing benefits and market share in case their production would be based on heartwood components. Glued laminated boards have a wide end-use application, *i.e.* doors, floors and panels, in which enhanced durability, dimensional stability and aesthetic value for the consumer can add value to the product. Windows are exposed to outside environment and higher durability and stability are needed to recover the market lost in recent years to PVC windows (Eastin et al, 2001).

Depending on end-use, some products might need the whole component volume to be of heartwood while others only require the visible face of heartwood. In this study the latter hypothesis was considered, thereby maximizing the sawing yields within the heartwood volume (Figure 2).

Regarding heartwood development in maritime pine stems, previous studies by Pinto et al (2004) have shown that it increases with age and in the older trees represents 17% of the stem volume (in 50% of the tree height). In general heartwood is regular and follows the growth ring outline. These features indicate a potential for the production of heartwood containing products.

The results obtained showed that log yields of heartwood products could attain 13% and 16% of log volume respectively for glued laminated boards and window components. The yield was highly variable with the log variables such as dimensions, original position in the stem and age, as well as with heartwood variables (Table 4). Therefore, yield for individual logs had a large spread, even when classified by diameter. For the higher diameter classes (>350 mm) batch yield of heartwood products were 7-8% of the log volume (Table 3). For the sawing simulation for glued laminated components, yield of heartwood products above 10% of log volume only occurred for logs for the LE stand, corresponding to the older trees. This stresses the importance of including a special selection of raw material within the log quality grading when the target is the production of heartwood products.

The variables that mostly impacted the sawing yield were log and heartwood top diameters and log position in the tree (Table 4). The highest yields were obtained when sawing 3 m logs, with top diameter above 375 mm and from the first 9 m of the stem of the older trees (83 years-old, LE stand).

The influence of log length (2 to 5 m) in yield was very small when sawing components without knot quality restrictions. This is in relation with the fact that a large number of component lengths was allowed, thereby obtaining a product with mixed lengths. Richards (1973) also reported a low impact of log taper and length on simulated sawing yields, when compared with the impact of other variables such as log diameter, sawing kerf, board thickness and edging method. The slightly better yields obtained for the 3 m logs (Table 3) probably results from the fact that these logs fit better the vertical heartwood profiles found for this species. The heartwood diameter proportion was maximum between 4-9 m of stem height; for the older trees, the maximum heartwood proportion (42% of stem diameter) was found, on average, at 8.8 m of stem height (Pinto et al. 2004). The heartwood volume proportion in the log showed the highest correlation with the sawing yield (Table 4). In fact, the second and third logs (3-6 and 6-9 m, respectively) showed the highest yields (around 8%) in accordance with their highest heartwood content (18%) (Figure 4).

Since heartwood and log diameters were the most influent variables on yield of heartwood products (Ylog) it is of interest to define a minimum diameter under which it is not possible to saw heartwood components (0% yield) or the yields are low. For the studied sample, these values were around 300 mm of log top diameter and 100 mm of heartwood top

diameter (Figure 5). Stem diameter and heartwood diameter have been related through a quadratic function (Pinto et al, 2004), and for a stem diameter of 300 mm the corresponding heartwood diameter is 110 mm, in accordance with the results found here. However, the variability of the results was high, mainly for Ylog in function of log diameter. In a range of 100 mm of log top diameter (from 350 to 450 mm) Ylog can change from 1.5% to 13%.

The selection of logs for production of heartwood components should not be done only in respect of log diameter, even if this was the log variable with the highest influence (Table 4). The heartwood diameter was also an important variable and since in maritime pine heartwood tapers fast, the position of the log in the stem (e.g. being a butt or a top log) is very significant. Log selection for heartwood products will produce the highest potential yields when all the above variables are considered. A good log grading targeting the sawing optimization of these products will therefore be achieved through an efficient traceability system and by adapting machine vision systems for detection of heartwood, *i.e.* x-ray (Oja et al. 2001, Grundberg 1999).

However, it is also possible to adapt traditional grading systems to the selection of potential good heartwood logs through the measurement of log and/or heartwood diameters. Log diameters can be measured with the existing shape scanners and heartwood diameter with systems such as infra-red scanning (Gjerdrum, 2002). In this study it was possible to fit equations to predict sawing yields (Ylog) in function of log and/or heartwood diameter (Table 5). though, at this stage, these are limited to the sampled trees.

Toverød et al. (2003) simulated the sawing of Scots pines, aged between 121 and 231 years, in logs with 60-70% of heartwood volume. They obtained yields around 20% of log volume and the best yields were achieved using logs with diameter above 250 mm. Log diameter was found as the most important variable for yield variation. They reported that optimizing the sawing for production of heartwood products could increase the final profit even if the volume yield decreases.

As regards the influence of product dimensions, better yields were achieved with smaller dimensions since these fit better the reduced heartwood volume when compared with the log volume. However it is the change on quality requirements, regarding the presence of knots, that mostly impacts on yield (Table 6) and product dimensional assortment (Figure 6). The yield (Ylog) is drastically reduced with the increase of the number of defect-free faces in the component, especially when changing from grade (4) to (3) (decrease of 3% in batch yield). It is possible to produce defect-free components though, in this case, 38% of the components had the smallest allowed width and length (75 and 400 mm, respectively, Figure 6).

These results are the consequence of the internal knot architecture in maritime pine trees. A previous study on the knot content in the older trees (LE stand), indicated that the knot core varied from 28% of tree diameter at the stem bottom to 84% of tree diameter at 70% of total tree height (Pinto et al., 2003). For the same trees, the proportion of heartwood varied from 34% of the stem diameter at the bottom, to 24% at the top. This means that most of the heartwood volume is included in the knot core volume and the production of knot-free components is then mainly dependent on the inter-whorl length.

In conclusion, it was possible to identify the variables that mostly impact sawing yield for the production of heartwood components (DTlog, DThtw and P). For the sample studied here only the largest logs from older trees achieved highest yields. Therefore the production of heartwood products from maritime pine stems is possible with an efficient log

grading system and additional efforts for selection of heartwood pieces after the conversion. However, the general low yields of heartwood products (Ylog) indicate that this production should carefully integrate the remaining products. Further work on sawing simulations and log sorting optimization programs will take into account the heartwood content of the pieces as an extra grading criterion.

5 LITERATURE CITED

- Bamber**, R.K. and K. Fukazawa. 1985. Sapwood and heartwood: a review. For. Abstr. 46(9):567-580
- Eastin**, I.L., S.R. Shook and S.J. Fleishman. 2001. Material substitution in the US residential construction industry, 1994 versus 1998. Forest Prod. J., 51(9), 30-37.
- Gjerdrum**, P. 2002. Sawlog quality of nordic softwood - measurable properties and quantitative models for heartwood, spiral grain and log geometry. Doctoral thesis. Dept. of Forest Sciences, Agri. Univ. of Norway, Ås, pp21
- Grundberg**, S. 1999. An X-ray LogScanner - a tool for control of the sawmill process. Doctoral thesis. Division of Wood Technology, Luleå Univ. Techn., pp30
- Hallock**, H., A.R. Stern and D.W. Lewis 1978. Is there a "best" sawing method?. Res. Pap. FPL-280. USDA Forest Serv., Forest Prod. Lab. 11 pp.
- Hillis**, W. E. 1987. Heartwood and Tree Exudates. Berlin: Springer Verlag. pp 268
- Ikonen** V-P., S. Kellomäki and H. Peltola. 2003. Linking tree stem properties of Scots pine (*Pinus sylvestris* L.) to sawn timber properties through simulated sawing. For. Ecol. manage. 174, 251-263.
- Leban**, J.M. and G. Duchanois. 1990. SIMQUA: A simulation software for wood quality. Annales des Sciences Forestiere (47):483-493.
- Maness** T.C. and Y. Lin. 1995. The influence of sawkerf and target size reductions on sawmill revenue and volume recovery. Forest Prod. J. 45(11/12):43-50
- Oja**, J., Grundberg, S. & Grönlund, A. 2001. Predicting the stiffness of sawn products by X-ray scanning of Norway spruce saw logs. Scand. J. For. Res. 16: 88-96.
- Pinto** I, H. Pereira and A. Usenius. 2002. Sawing simulation of *Pinus pinaster* Ait. in Proceedings of Fourth workshop in "Connection between Silviculture and wood quality through modelling approaches and simulation softwares". British Columbia. Ed. G. Nepveu, INRA, Nancy.
- Pinto** I, H. Pereira and A. Usenius. 2003. Analysis of log shape and internal knots in twenty maritime pine (*Pinus pinaster* Ait.) stems based on visual scanning and computer aided reconstruction. Ann. For. Sci. 60: 137 - 144
- Pinto** I, H. Pereira and A. Usenius. 2004. Heartwood and Sapwood development in maritime pine (*Pinus pinaster* Ait) stems. Trees, *in press*.
- Richards**, D.B. 1973. Hardwood lumber yield by various simulated sawing methods. Forest Prod. J. 23(10):50-58
- Schmoltdt** D., P. Li and P. Araman. 1996. Interactive simulation of hardwood log veneer slicing using CT images. Forest Prod. J. 46(4):41-47.
- Song**, T. 1987. Optimization of sawing decision making through computer simulation. Laboratory of mechanical wood technology, Helsinki University of Technology, Licenciate thesis, Espoo, pp 109
- Song**, T. 1998. Tree stem construction model for "Improved spruce timber utilisation" project. VTTs Building Technology internal report. Helsinki pp 20

- Stokes**, A. and S. Berthier. 2000. Irregular heartwood formation in *Pinus pinaster* Ait. is related to eccentric, radial, stem growth. *For. Ecol. Manage.* 135: 115-121
- Taylor** A M, B.L. Gartner and J.J.Morrell. 2002. Heartwood formation and natural durability - a review. *Wood Fiber Sci.* 34(4): 587-611
- Todoroki**, C.L. 1994. Effect of edging and docking methods on volume and grade recoveries in the simulated production of flitches. *Ann Sci For* 51, 241-248
- Todoroki**, C.L. 1996. Developments of the sawing simulation software AUTOSAW - linking wood properties, sawing and lumber end-use. In: *Proceedings of the Second Workshop on Connection Between Silviculture and Wood Quality through Modelling Approaches and Simulation Softwares*, South Africa, Ed. G. Nepveu, INRA, Nancy, pp 241-247
- Toverød** H., Øvrum A. and Flæte P.O. 2003. Potential for conversion of heartwood timber from logs of Pine. Oppdragsrapport 1/03. Skogforsk (In Norwegian).
- Usenius**, A. 1999. Wood conversion chain optimisation. in: *Proceedings of Third workshop on Connection between Silviculture and Wood Quality through Modelling Approaches and Simulation Softwares*". La Londe-Les-Maures. Ed. G. Nepveu, INRA, Nancy, pp 542-548.
- Usenius**, A. 2000. WoodCim® - Integrated planning and optimizing system for sawmilling industry. VTTs Building Technology internal report. 8 pp

Author(s) Pinto, Isabel			
Title Raw material characteristics of maritime pine (<i>Pinus pinaster</i> Ait.) and their influence on simulated sawing yield			
Abstract The objective of this work was to study maritime pine (<i>Pinus pinaster</i> Ait.) wood characteristics and their impact on the sawing yield using virtual stem models and sawing simulation procedures. In the first part of the work, a characterisation of maritime pine as raw material for the wood industry was performed. The stem shape, distribution of knots, and heartwood/sapwood contents were studied. In the second part of this work, the virtual stems provided the raw material for sawing-simulation studies. The stem reconstruction, bucking, and sawing simulation modules of WoodCIM® were used. WoodCIM® is an integrated optimising software system, developed at the Technical Research Centre of Finland (VTT), for the optimisation of the wood conversion chain. The software was adapted for maritime pine and validated. Thirty five maritime pine stems were randomly sampled from 4 sites in Portugal. These were mathematically reconstructed into virtual stems, based on image analysis of flitch surfaces. The 3D virtual stems included the description of external shape, internal knot architecture, and heartwood core. The reconstruction of the heartwood shape was a new feature added to the reconstruction module during this study. Input data concerning final products and process variables for sawing simulation were obtained directly from the wood-based industry. The average volume percentage of knots in 83 year-old maritime pine trees, varied from 0.07% for butt logs to 1.95% for top logs. Heartwood diameter either followed the stem profile or showed a maximum value at the height 3.8 m, on average, while sapwood width was higher at the stem base and after 3 m remained almost constant along the stem height. Production yields were higher for logs with origin of the first half of the stem as diameters were large and taper reduced when compared with top logs. Butt logs showed the highest value yields because of the knot core profile. When the target was to maximise the production of heartwood containing components, best yields were obtained with logs bucked between 3 and 9 m height. The results in this study increased the basic scientific knowledge about maritime pine concerning the variations of wood characteristics and their influence on sawing yield outputs. Also, these can contribute to further development of industrial applications of defect detection and sawing simulation tools.			
Keywords maritime pine, <i>Pinus Pinaster</i> Ait., 3D stem models, stem shape, knots, heartwood, sapwood, sawing simulation, production yields			
Activity unit VTT Building and Transport, Betonimiehenkuja 5, P.O.Box 1806, FIN-02044 VTT, Finland			
ISBN 951-38-6373-5 (soft back ed.) 951-38-6374-3 (URL: http://www.vtt.fi/inf/pdf/)			Project number
Date September 2004	Language English	Pages 51 p. + app. 69 p.	Price C
Series title and ISSN VTT Publications 1235-0621 (soft back ed.) 1455-0849 (URL: http://www.vtt.fi/inf/pdf/)		Sold by VTT Information Service P.O.Box 2000, FIN-02044 VTT, Finland Phone internat. +358 9 456 4404 Fax +358 9 456 4374	

The multidisciplinary research carried out in this work focuses on the interaction between forestry, harvesting, and industrial wood conversion. The objective is to increase the basic scientific knowledge on maritime pine (*Pinus pinaster* Ait.) wood characteristics and their influence on sawing yield outputs.

Mathematical reconstruction algorithms were used to produce 3D virtual models of logs and stems of this species. These provided the data for studying raw material characteristics as log external shape, internal knots, and heartwood/sapwood contents. A sawing simulation tool used this virtual raw material as input to provide data for studies concerning maritime pine production yields.

The results contribute to the improvement of this species' utilisation as a raw material for the solid wood industry. Also, these can contribute to further development of industrial applications of defect detection and sawing simulation tools.

Tätä julkaisua myy VTT TIETOPALVELU PL 2000 02044 VTT Puh. (09) 456 4404 Faksi (09) 456 4374	Denna publikation säljs av VTT INFORMATIONSTJÄNST PB 2000 02044 VTT Tel. (09) 456 4404 Fax (09) 456 4374	This publication is available from VTT INFORMATION SERVICE P.O.Box 2000 FIN-02044 VTT, Finland Phone internat. +358 9 456 4404 Fax +358 9 456 4374
---	---	---