



Green Solutions

for Water and Waste



Research highlights in
**Green Solutions for
Water and Waste**

ISBN 978-951-38-7964-8 (Soft back ed.)

ISBN 978-951-38-7965-5 (URL: <http://www.vtt.fi/publications/index.jsp>)

VTT Research Highlights 4

ISSN-L 2242-1173

ISSN 2242-1173 (Print)

ISSN 2242-1181 (Online)

Copyright © VTT 2013

PUBLISHER

VTT Technical Research Centre of Finland

P.O. Box 1000 (Tekniikantie 4 A, Espoo)

FI-02044 VTT, Finland

Tel. +358 20 722 111, fax +358 20 722 7001

EDITOR: Kaisa Belloni

TECHNICAL EDITING: Marika Leppilahti

GRAPHIC DESIGN: Tuija Soininen

Printed in Kopijyvä Oy, Kuopio, 2013

Green Solutions for Water and Waste spearhead programme – insights to early activities

The Green Solutions for Water and Waste (GWW) spearhead programme was launched at the beginning of 2011. The vision of the GWW programme is a zero emission society. For that, our goal is to create technological stepping stones towards sustainable water use, efficient material resource management using our internationally recognised, trans-disciplinary competence.

Sustainable technologies for water and waste

Industries and the society are facing new challenges relating to securing increasingly critical resources due to a growing population, urbanisation, and globally increasing middle-class with higher consumer purchasing power and changing spending habits. Increasing resource efficiency is of key importance in securing the economy and employment and it is now seen as the future for societies and economies to evolve and prosper in the coming era of scarcity of natural resources. Materials shall be saved, recycled and reused across all industries.

In order to meet the future demand for mineral and water resources, we need to develop new ways to reduce the withdrawal of natural resources to water and mineral intense industries. This means optimised production processes for minimised waste production and reduced water use and in a larger context developing industrial symbiosis concepts for sustainable management of resource stocks.

Generally, awareness around protecting and improving the quality of our environment is rapidly increasing. The principles of ecological efficiency and sustainability are strong drivers for both society and industry. Cleantech markets and business opportunities are steadily growing and support the progress towards zero emission processes.

For the research community, sustainable development is a very inspiring challenge. To find the best innovations and solutions, wide know-how and integration of various disciplines are needed. As a multi-technological research organisation with comprehensive networks, VTT is in a good position to meet these challenges.

How will future societies manage their water?

Fresh water is emerging as the most critical resource issue facing humanity. As the World Bank has warned, lack of water is likely to be the major factor limiting economic development in the decades to come. On the other hand, scarcity and increased cost of water is also enabling the development of new innovations such as mobile decentralised purification systems, recycling water in closed systems, water harvesting and smart monitoring solutions. Climate change will have a significant impact on the sustainability of water supplies in the coming decades. Extreme events call for new solutions in water management. Exceptional droughts motivate to develop smart networks that monitor their own condition

and leaks, assess water availability and predict demand. Higher risk for flooding requires better forecasting tools and innovative urban infrastructures to mitigate flooding impacts.

Water, both as a topic and as a resource, spans across multiple industries and businesses. Depending on the industrial sector, the cost of water may already represent several per cent of production costs. The pulp and paper and the steel and mining industries, energy production, and the chemical sector are among the industrial sectors that the European Water Technology Platform (WSSTP) has identified as high water consumers and potential polluters facing significant challenges for diminishing consumption and the emissions to the environment.

It has been predicted that the impact of water scarcity and declining water quality on business will be far-reaching. Many companies worldwide are already seeing more stringent regulations for effluent treatment, higher costs for water and growing community opposition against industrial allotments. Fresh water – as sources for drinking and irrigation water – is also becoming a political matter. Energy and cost efficiency in drinking water production is an increasingly important issue. At the same time, tightening legislation concerning pollution limits calls for enhanced and improved wastewater treatment together with new monitoring needs.

GWW's foci in water research concern developing new sensors for assessing water quality, solutions for monitoring and diminishing fouling in membrane processes, biomimetic approaches for removing micro-pollutants from effluent water, and enhanced energy efficiency in sludge treatment.

The collaboration with Kemira in the SWEET Center of Water Efficiency Excellence cuts across a wide range of aspects of water chemistry. The partnership has resulted in new inventions and common publications, presented at the world's largest water event – the Singapore International Water Week.

On the national arena, VTT's Green Solutions for Water and Waste Spearhead

Programme, in collaboration with the Finnish National Funding Agency Tekes, arranged in 2011 an international seminar on future water technologies with an emphasis on membrane technologies. VTT itself is building its membrane competence in close collaboration with NTU Singapore, one of the most prominent research centers in drinking water technologies.

Among water-intensive industries the mining industry has emerged as a new, important stakeholder group with and for which VTT is developing water treatment solutions relating to the removal of organic pollutants and heavy metals. Green mining issues touched also the topic of 2012 international seminar "From sustainable mining to ecodesign". The topic was resource efficiency combining recycling and ecodesign.

Seeing waste as a resource – reuse, recycling, and recovery

The inevitable lack of abundant raw material supplies in the future is a great challenge for society as a whole. As more and more people are entering the middle-class around the globe, their consumption habits indicate the increasing need for mineral resources. The other major factor contributing to the growing demand of raw materials is the increasing world population.

From a European industrial point of view, securing reliable and undistorted access to raw materials is crucial for the sound functioning of the EU's economy. While 70% of the EU's manufacturing is based on minerals and Europe is increasingly importing natural resources from other world regions, the sustainable use of raw materials and developing innovative sources for industrial raw materials are high on the agenda.

VTT aims to be a strong player and partner for a resource-efficient society and industries that avoid waste and use the remaining waste as a resource. The emphasis is moving from single waste treatment solutions towards industrial ecology, or even more, designing for the environment, which

is a strategic approach that involves preventing and minimising environmental impacts over the entire product life cycle, from raw material extraction to disposal (including possible rounds of recycling and reuse).

The GWW programme has staged large scale activities in developing processes for extracting and recovering minerals from waste matrices. In addition to the recovery of metals, VTT is developing innovative phosphorous recycling technologies that utilise waste and wastewater and low grade resources in a cost efficient way. For instance, modelling engineered biochemical reactions taking place on the surface of mineral materials can give useful insight when developing chemical and biological extraction processes.

Collaboration with Europe's major research organisations in AERTO (Associated European Research and Technology Organisations) has been strengthened through the launch of a common project on the recovery of high-tech metals from waste flows. The project derives from the organisation's strategic research on value from waste. VTT contributes with inventories, systems analysis and dynamics of scarce metals in waste and extraction methods for low concentrations of scarce metals, among other things.

The sustainable cultivation of algal biomass using waste flows builds on VTT's competence in biotechnology and renewable fuel production. In addition to providing a solution for certain wastewaters, the algal biomass can be utilised in several ways, as raw material for diesel, biogas and carbon dioxide sequestration. Moreover, the residual contains potentially valuable polymers. Such integrated concepts have varied beneficiaries and function as a showcase on our route to combining individual environmental technologies to cross-technological integrated concepts.

VTT's Green Solutions for Water and Waste Spearhead Programme builds on a long tradition in the development of sustainable technologies. The ability to create

efficient solutions based on a multi-technological approach and deep know-how in various disciplines forms the basis for VTT's competitive edge in environmental technologies.



Contact at VTT:

MONA ARNOLD
Programme Manager
mona.arnold@vtt.fi
+358 40 568 1222

Contents

Green Solutions for Water and Waste spearhead programme – insights to early activities	3
VTT takes the challenges in water treatment technology development	7
Enabling water reuse – membrane technologies	12
Cost efficient management of sludge and concentrates	18
Faster and more economic monitoring tools for water quality assessment	25
Mining in the organic waste mountains	30
Counteracting material scarcity	34
New business concepts based on integrated valorisation of waste streams	38
Related publications	41

VTT takes the challenges in water treatment technology development

Contributing authors:

Anu Kapanen, Leena Carpen, Mari Raulio,
Mikko Vepsäläinen, Minna Vikman

Global drivers in the development of water treatment technologies rise from water scarcity, climate change, and the increasing need for clean water production and water reuse. The challenges for research in the rapidly developing water treatment sector are to find economically feasible and sustainable solutions to ensure the safe and sufficient water supply for an ever-increasing world population.

Industrial and municipal wastewater effluents are the major sources of pollutants released into the environment, causing the chemicalisation of water ecosystems. Even though wastewater treatment plants (WWTPs) are able to treat efficiently high organic loads, many chemicals including organic pollutants and micropollutants, such as pharmaceuticals, hormone-like compounds (endocrine disruptors) and other toxic and persistent chemicals,

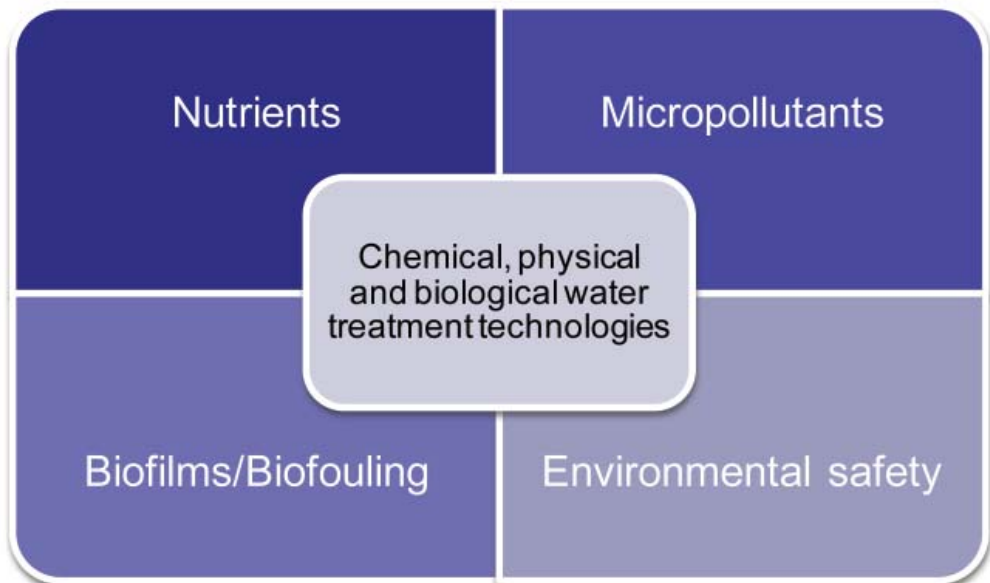

Figure 1. Improved water treatment technologies target the removal of nutrients and pollutants from water streams together with management of biological processes, such as biofouling, occurring during water treatment. Sustainability and safety of developed processes are key elements in all of VTT's water-related research.

pass through the treatment process and end up in the sea and other waterways. The concentration of these pollutants present in the effluent streams is generally very low, from nanograms to picograms per liter. However, they can be transported via natural food chains and bioaccumulate in living organisms. Pollutants released into the water ecosystems can therefore cause severe damage to humans and the environment. More efficient treatment technologies are needed to remove not only readily biodegradable, organic matter and pathogens, but also persistent organic and inorganic pollutants.

In the areas of environmental engineering and biotechnology VTT offers an interdisciplinary research approach to the development of new solutions for different water treatment applications. This chapter describes how VTT aims at improved chemical, physical and biological water treatment concepts for nutrient and pollutant removal. Factors that need to be taken into account when developing solutions for water treatment are depicted in Figure 1.

Problematic micropollutants in wastewater

The overall goals of wastewater treatment are to prevent pollution of the environment and to protect human health. Over the last few years the removal of organic and inorganic micropollutants from wastewater has become an even more important issue. Effluent constraints have become progressively more stringent and thus in many cases, current wastewater treatment processes have difficulties meeting the new requirements. There are several reasons for the poor removal of organic micropollutants in currently applied municipal wastewater treatment processes. For example, the microorganisms used to degrade the organic load in waste water first utilise the easily biodegradable compounds, because they give a high energy yield, while pollutants that are not 'readily biodegradable' and/or present at low concentrations pass through untouched. In fact, the removal of complex mixtures contain-

ing micropollutants may require combinations of treatment methods, either by combining physico-chemical and biological treatments or, when necessary, by dividing the biological treatment into multiple phases.

At VTT, technologies and their combinations are studied and developed to achieve more efficient removal of micropollutants. Applied methods include chemical, physical and biotechnological treatment technologies. Examples of physical methods that have been combined with chemical treatment are ultrasonic and hydrodynamic cavitation; that is, the momentary creation of tiny vacuums within the treated liquid, at different frequencies to achieve the tailored removal of micropollutants from wastewater. In addition, the efficacy of two different types of biofilm processes, that is, moving bed bioreactors (MBBR) and packed bed bioreactors, in removing micropollutants from both wastewater and grey water has been studied. In these biofilm processes, monitoring the biofilm structure and function of microbial communities in biofilms enhances the possibilities of process management. In addition, the impact of the carrier material in biofilm processes on biofilm structure and micropollutant removal efficacy has been analysed.

Enzyme technologies

To overcome some of the deficiencies related to traditional chemical and biological water treatment processes, it is possible to use enzymes to catalyse the transformation of the target pollutant. Among the oxidative enzymes, polyphenol oxidases (e.g. tyrosinase, laccases) and oxidoreductases (e.g. peroxidases from horseradish, soybeans) have shown a potential for wastewater treatment applications. Laccases are known to have the ability to degrade e.g. estrogens and naproxen whereas peroxidases have been used for antibiotics removal. In the "Green Solutions for Water and Waste" spearhead programme, VTT invests in development of novel enzyme technologies to improve water quality.

Biomimetics in water treatment

Biological systems characteristically perform complex functions with precision and efficiency and thus there can be great advantages in taking inspiration from the biological world to our technological challenges. By learning from biological solutions for efficient water filtration and purification we can develop new bioinspired technologies. VTT explores opportunities for biomimetics in water treatment focusing on the specific removal of micropollutants and new ways of replacing membrane-based systems by biomimetic processing and adsorbent systems.

Characterisation of extracellular polymeric substances (EPS) reveals new insights to water treatment processes

Microorganisms, such as bacteria, virus, mould, yeast and other unicellular organisms, exist in natural habitats as well as man-made ecosystems predominantly as matrix-enclosed multi-species communities; that is, microbial aggregates such as biofilms. In wastewater treatment, the microbial aggregates are actually useful for the treatment process since the microbes consume organic material present in wastewater, eventually breaking it down to water and carbon dioxide.

The matrix in which microbial aggregates and biofilms usually exist is composed of extracellular polymeric substance (EPS), produced by the microbes themselves. The actual composition of the extracellular matrix or EPS in microbial biofilms depends on the producing microbes and hence has as much variation as there are biofilm-forming microbial species. However, it can be said that EPS is composed of high molecular weight compounds, including polysaccharide, protein, nucleic acids, humic substances and ionisable functional groups like carboxylic, phosphoric amino and hydroxyl groups. In addition to these, in wastewater treatment environments EPS also contains un-metabolised wastewater components.

The relationship between the amount and composition of EPS and water treatment process performance is often controversial. The presence and composition of EPS have an impact on how behaviour of microbial aggregates (flocculation, settling, and sludge dewatering) as well as on biofouling properties, microbial adhesion, and the efficacy of chemicals used. At VTT the role of EPS composition has been studied in conventional activated sludge and membrane bioreactor (MBR) processes. The research focused on evaluating how the EPS composition and structure of sludge can be studied with microscopy, applying various staining methods. For fluorescence microscopy or confocal laser scanning microscopy (CLSM), the EPS components can be stained with fluorochromes specific to certain polymers or with fluoroconjugated lectins, which are sugar-binding proteins. Applying multiple labelling techniques for staining EPS components in sludge specimen can help to visualise its structure by showing the occurrence and location of biopolymers and micro-organisms in three dimensions. Using visualisation and labelling as tools, we can monitor the changes in the sludge structure as well as spatial distribution and interrelationships of EPS constituents in relation to the purification process. In the future, advanced EPS analysis may be a valuable tool in the development of innovative water treatment processes. Figure 2 shows examples of maximum intensity projections of CLSM images of sludge samples stained with fluoroconjugated lectins.

Bench-scale facilities for industrial cooling water environments

Water is an essential component in the energy generation process, and according to certain studies, over 50 % of the water consumed in industries globally is used to generate power¹. In power plants, water is used for various applications, namely cooling, boiler makeup, stack gas cleaning, ash transport, turbine inlet and so on. Especially cooling water systems

¹ Frost and Sullivan 2011. Strategic Analysis of Water and Wastewater Management in the Power Industry.

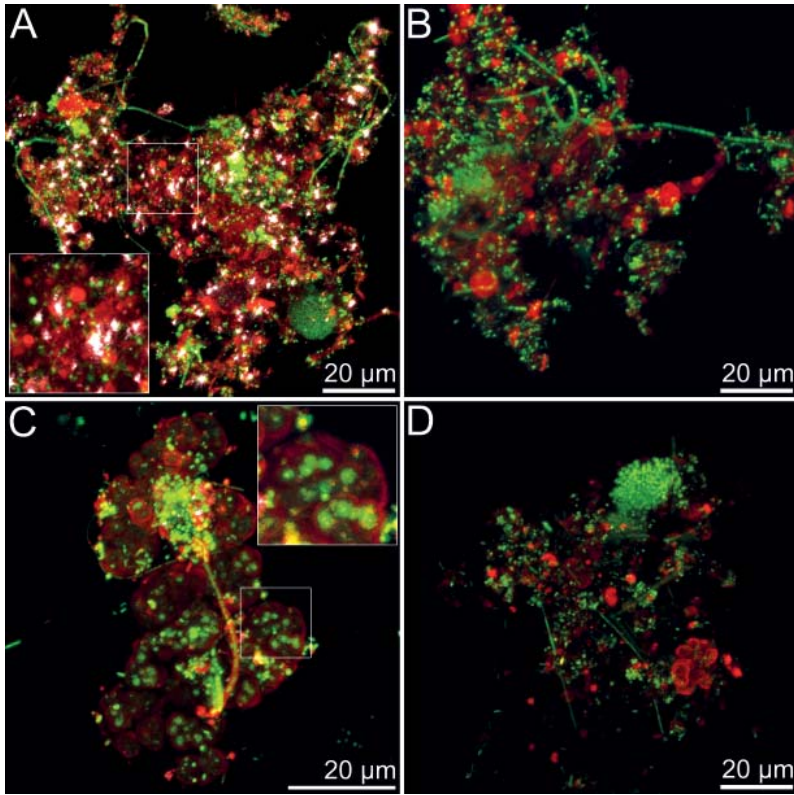

Figure 2. Confocal microscopy image of activated sludge stained with a fluorochrome staining nucleic acids of microbial cells green and fluoroconjugated lectins staining polysaccharides red. Lectin from *Aleuria aurantia* (Panels A and B) – or *Helix pomatia* (Panels C and D) was used. The enlargements of the framed areas Panels A and C show that *A. aurantia* -lectin stained matrix of the flock whereas *H. pomatia* -lectin stained tightly bound EPS of certain bacteria.

of power plants and other industrial plants use large amounts of water.

Due to a shortage of high quality water in many locations, companies have initiated various steps to reduce their water usage and the overall water footprint. These systems have to operate with a high water reuse and circulation rate. High circulation rate increases corrosion, scaling and fouling problems. Microbiological growth and inorganic scaling reduces heat-transfer of the equipment and accelerates further corrosion rates. Corrosion reduces the lifespan of equipment and furthermore increases scaling and fouling of the system.

In addition, microbiological growth can cause occupational hazards (such as legionellosis).

Chemicals, such as antiscalants, biocides and corrosion inhibitors, are normally used to reduce corrosion, scaling and fouling. However, these currently used chemicals may have functional limits, such as toxicity, increased operating costs and potential to cause eutrophication and increased vegetation in surrounding water areas. Therefore, there is a demand for the development of new types of solutions for power plants, the petrochemical and chemical industry, the food industry and pulp and paper mills.

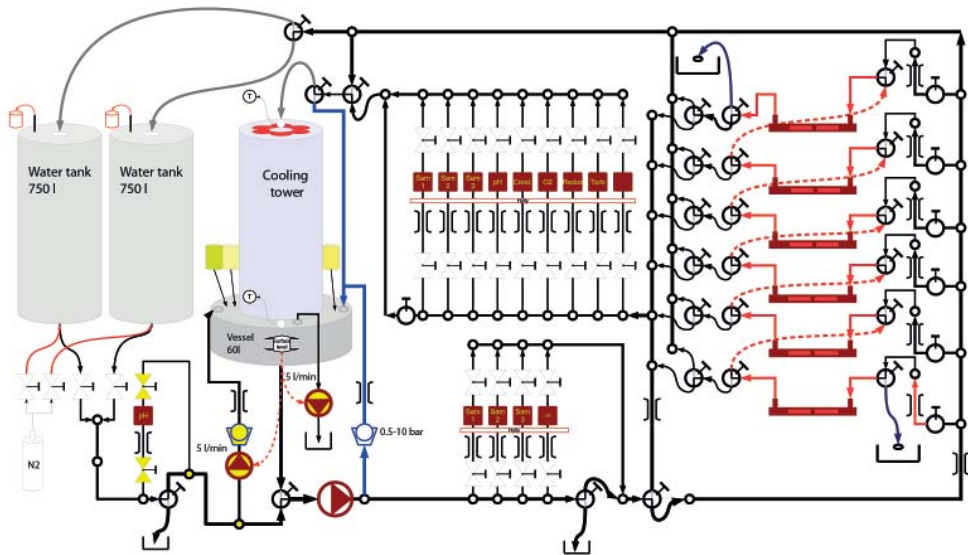

Figure 3. Schematic layout of the bench-scale cooling water system. Water circulation system contains similar components as real cooling water systems, e.g. cooling tower and heated tubes simulating a heat-exchanger. Online water chemistry sensors are used to monitor water quality in the system during the studies. Several heated and non-heated construction material samples can be exposed to the cooling water environment. The bench-scale system can be used in corrosion, scaling and fouling studies.

At VTT, new methods are developed to prevent and detect scaling, fouling and corrosion. A new bench-scale test system depicted in Figure 3 has been constructed at VTT for simulating open, closed and once-through cooling water environments. The system comprises several online sensors for water chemistry, corrosion and fouling measurements. This new bench-scale test system enables the development and verification of in situ measurement technologies for water chemistry, characterisation of surface properties of construction materials and dispersed colloidal particles. In addition, sensors for studying the mechanisms and prevention of fouling and corrosion phenomena with chemicals and/or coatings can be applied or developed. Adhesion of microbes, organic foulants and inorganic scalants on metal surfaces and coatings can also be studied in this bench-scale test system.



Contact at VTT:

MINNA VIKMAN
Senior Scientist
minna.vikman@vtt.fi
+358 40 525 7428

Enabling water reuse – membrane technologies

Contributing authors:
Juha Sarlin, Juha Nikkola

Membrane technology is a key water treatment method, above all in the production of drinking water and in industrial processes where high quality separation is required. That is to say, with membranes one can produce high quality water or separate specific wanted or unwanted molecules from the water flow.

Membranes are thin selective polymer or ceramic filters with varying pore size. Depending on the pore size, these filters can retain particles, bacteria, chemical pollutants and salts by acting as a physical barrier. The most widely-applied membrane technology in water is reverse osmosis (RO), which is commonly used for drinking water production from seawater, removing the salt and other substances from the water. By coating the membranes, e.g. with a catalytic layer, membranes are given functional abilities enabling the simultaneous degradation of the separated pollutants on the membrane surface. These functional membranes offer potentially viable solutions for treating new emerging contaminants, such as pharmaceutical substances, that are increasingly released to wastewaters.

However, the energy consumption of the method is also high due to the required pressurisation of the treated water. Energy consumption plays a remarkable role in the most commonly-applied membrane processes of nanofiltration (NF) and reverse osmosis (RO).

Challenges and emerging technologies in membrane based water treatment

The two main challenges in water treatment using membrane technologies are improving energy efficiency and increasing the separation performance. The former relates to controlling membrane fouling, the latter again is coupled with current membrane materials. Membrane fouling can be either inorganic (scaling) or organic (biofouling). Scaling is usually prevented by modifying water chemistry through the addition of antiscalants, whereas biofouling can be minimised by the right choice of membrane material or surface development.

Biofouling is one of the most critical problems in water treatment plants. In processes, biofouling causes flux reduction, increased operational pressure, pressure drop, energy efficiency reduction and membrane damage. In water treatment plants, the prevention and control of biofouling is performed mainly by applying effective conventional pre-treatment systems, which remove suspended solids and colloidal material. In addition, the choice of the membrane material affects the build-up of biofouling. The mature biofilm comprises several microbial species and extracellular polymeric substances (EPS, described in more detail in the previous chapter). The ideal material is low – or non-adhesive, preventing microbes and EPS from attaching to the surface.

Membrane research at VTT has mainly focused on preventing biofouling through membrane surface modifications. Membrane modifications aim at limiting the fouling phe-

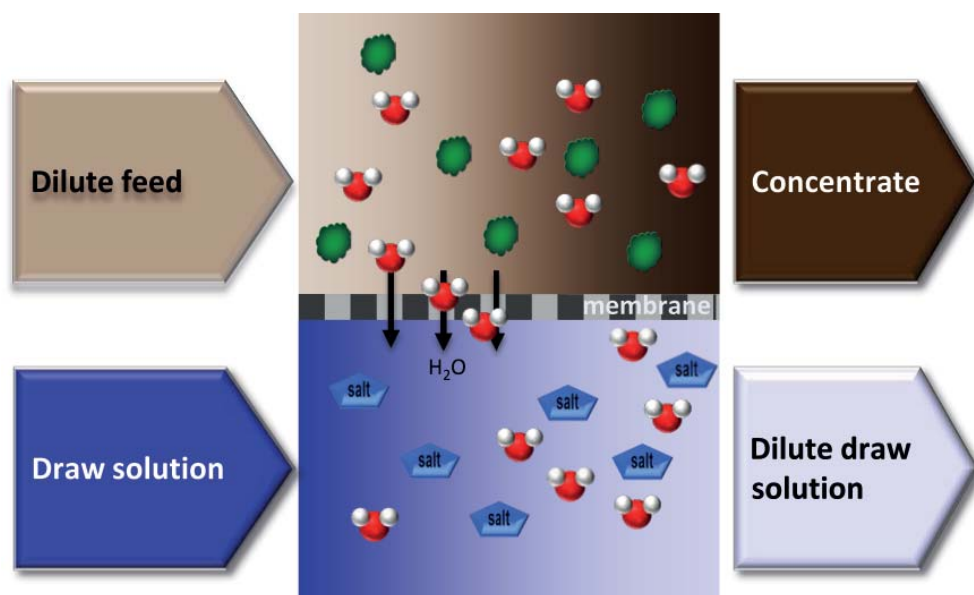

Figure 1. Forward osmosis as a water treatment method is based on the difference in osmotic pressure of the liquid to be treated (dilute feed) and the draw solution. Draw solution has high osmotic pressure due to its salt content and hence it absorbs water through the membrane from the dilute feed and thus concentrates it. Since the water content of the draw solution increases in the process, it becomes diluted. In order to obtain purified water the dilute draw solution must be desalinated.

nomena and enable a combination of filtration with a breakdown of pollutants and other unwanted substances.

In addition to lower energy consumption of the treatment process and decreased fouling tendency, forward osmosis (FO) technology offers essential improvements in membrane technology, such as high separation performance, but improvements are needed to realise these advantages in large-scale operations. VTT is among the first to develop an FO technology-based water recycling solution for water-intensive industries such as the mineral and biorefinery industry. Another emerging technology developed at VTT is based on photocatalytic reactions to decompose organic harmful and toxic compounds in water. Essentially the VTT water treatment platform also includes membrane surface modification technologies as well as

the physical -chemical and techno-economic modelling of related phenomena.

Forward osmosis as a way of improving energy efficiency

Forward osmosis (FO) is a novel membrane separation technique, which has several advantages over the widely-applied reverse osmosis (RO), such as lower energy consumption and decreased fouling. These advantages of FO are obtained because the pressure needed in the process is low.

In FO, the solvent will move across the membrane from lower-solute-concentration side to the higher concentration-solute side and only the liquid circulation causes the hydraulic pressure. In traditional RO, the water in concentrated feed solution is “pushed” through a semi-permeable membrane by applying an external pressure. The energy

consumption depends on the applied pressure, which also influences the fouling of the membrane. Due to this difference the FO method is also suitable for, for example, fluids which do not tolerate high pressures or temperatures and hence of interest to food and pharmaceutical processes, for example. The principle of the FO method is depicted in Figure 1.

However, the greatest challenges in FO relate to the membranes and the draw solutions. The FO membranes should possess both high flow rates and high salt rejection. Furthermore, draw solutes with high osmolality and easy separation from water would be needed. Replenishment and regeneration of the draw solution can then become the most expensive part of FO.

Crucial to the economic viability of FO processes is to be able to use the diluted draw solution without reconcentration. When concentrate solution needs dilution before use, it the needed water can be taken from solution that requires concentration. For example, concentrated fertiliser solution can be used as draw solution until it is diluted to a level appropriate for use as irrigation water or glucose in the food processes.

The FO research work at VTT focuses on the instrumentation, applications and development of novel potential draw solutions and new membrane structures. The technique has been tested widely in desalination tasks, but only very few applications in industrial environments exist so far. In fact, in VTT's activities a special focus is given to industrial processes where the process could be applied. Potential and novel applications for FO include (but are not limited to) concentration and purification of waters in the mining, chemical, and pulp and paper industries.

Photocatalytic technology allows breakdown of pollutants within wastewater

Photocatalytic water treatment is generally regarded as a technology with remarkable

potential in the near future, since the desired chemical and physical degrading effects can be obtained without the addition of harmful and toxic chemicals in the treatment process. The technology relies on photocatalytic reactions breaking down the contaminant molecules, leaving no residue of the original material. Therefore, less sludge requiring disposal or further treatment is produced. The catalyst itself is unchanged during the process and no consumable chemicals are required.

In water treatment the method has the potential to solve problems caused by the wide range of organic contaminants, such as pesticides and residuals from, for example, the cosmetic and pharmaceutical industry. Whilst the worldwide consumption of these chemicals is increasing - a typical effect of increasing living standard - these chemicals occur more commonly in wastewater and nowadays also in ground water. A further advantage of the photocatalytic technology is that it can utilise solar light as an energy source, and this fact supports applications in areas without modern infrastructure.

Modifying membrane surface to reduce fouling

Membrane surface modification research aims to develop new surface treatments, which provide anti-fouling performance for commercial RO and NF thin-film-composite (TFC) polyamide (PA) membranes. Furthermore, the aim is to investigate the potentiality of the existing thin film technologies (e.g. sol-gel, ALD and plasma) to develop new possible coating materials to be used in membranes. Due to the non-porous or semi-permeable surface structure of RO and NF membranes, the fouling phenomenon is especially harmful, since even a thin additional layer on top of the membrane reduces its actual performance, e.g. flux.

In the prevention of biofouling, the membrane surface properties, including hydrophilicity, low surface roughness and neutral surface charge, are the key factors.



Figure 2. Thermo-responsive cellulose-based membrane. Bio-based membranes decrease the need for material produced from fossil resources, thus supporting sustainable development.

These are essential when developing new membrane materials or surface modifications. In addition, the membrane surface should resist mechanical forces as well as physical and chemical cleaning. The existing solution in the commercial anti-fouling membranes is to either increase hydrophilicity through thin polymeric coating, or to increase membrane flux through the incorporation of flux enhancers. New development routes for low-fouling membranes include new polymer blends (e.g. polyethylene oxide PEO, polyacrylonitrile PAN), nanoparticle incorporation (e.g. zeolites and carbon nanotubes), surface grafting by chemical or physical methods, and the incorporation of antimicrobial agents (e.g. silver, copper, zinc and quaternary amine).

In addition, membranes can be constructed from materials allowing functional properties, for example, for controlled adsorption and the release of chemical substances. One interesting possibility is the inclusion of

stimuli-responsive properties. Stimuli-responsive membranes undergo reversible changes in their surface composition and properties, induced by an external stimulus such as a change in temperature (Figure 2). The induced changes in the membrane surface cause the biofouling to detach more easily from the membrane surface. The smart, stimuli-responsive polymers developed at VTT have been shown to improve the washing of fouled filter materials, thus saving energy and chemicals and decreasing the need to change filters.

VTT's offerings for membrane research

Like in almost all engineering, modelling has a great role to play in membrane technology development. Covering several time and distance scales, models developed and used at VTT range from those concentrating simply on the membrane and its interactions close to the surface or to entire industrial sites utilising



Figure 3. Equipment and a module for reverse osmosis research for e.g. desalination solutions.

membrane operations. Operation optimisation deals largely with how to achieve minimal energy consumption combined with maximised separation efficiency. Such modelling references have e.g. dealt with defining optimal wash cycles and how to connect and run systems of several filters. The models rely always on data produced either at process plant or with dedicated pilot or laboratory tests. Both backward analysis and future estimation are elementary outputs in the developed models.

New industrial applications or concepts are developed in close cooperation with companies. Comprehensive technical resources are a must for successful results. These include a range of membrane technology equipment in laboratory and pilot-scale micro-filtration (MF), ultrafiltration (UF), nanofiltration (NF) and reverse osmosis (RO) (Figure 3). Mobile/portable equipment also enables testing onsite with real wastewater.

Current application projects at VTT deal widely with biofouling/scaling prevention or cleaning of membranes, especially by new chemicals and ultrasound technology, solutions for water reuse in the pulp and paper industry, and the real-time fouling measurement of membranes.



Contact at VTT:

JUHA SARLIN
Senior Scientist
juha.sarlin@vtt.fi
+358 40 517 1433

Biofouling – typical challenge in water treatment

In nature and in process environments, microbes grow as multi-species communities (biofilms) attached to surfaces where they are better protected from the action of antimicrobial agents and environmental stresses. The microbial cells interact closely with each other and they cooperate in obtaining nutrients and metabolic compounds. The biofilm structure provides the cells with protection from an exposure to external agents (e.g. biocides, antibiotics). In particular, extracellular polysaccharides (EPS) play various protective roles in the structure formation and function of different biofilm communities. In addition, polysaccharide capsules present on bacterial surfaces strengthen interactions between microbes. Biofilm formation depends on interaction between the bacterial cells, the attachment surface and the surrounding medium.

The structure and composition of the outermost layer of the cells differ greatly between bacteria. On the outer envelope, cells may have polysaccharide capsules or protein, which protect bacteria in unfavourable conditions and affect their adhesion. Some bacteria have additional structures, such as short thin appendages in their outermost cell layer. It is suggested that these structures, in association with other components outside the cell, create a coating that affects biofilm formation and cell-to-cell attachment.

Cost efficient management of sludge and concentrates

Contributing authors:
Pentti Pirkonen, Mona Arnold, Elina Merta

Sludge is the major by-product from wastewater treatment facilities and processes. Traditionally, sludge has clearly been seen only as waste material; something to dispose of at a low a cost as possible. The characteristics of sludge are greatly influenced by the quality and characteristics of the original wastewater to be treated as well as the actual treatment process unit. Moreover, organic and inorganic pollutants tend to end up in sludge, making its utilisation and disposal both expensive and troublesome. On the other hand, wastewater treatment also results in a concentration of valuable compounds in the sludge. For example, the concentration of nitrogen and phosphorous is typically high in sludge and the content of metals can be high, especially in sludge from industrial processes. Hence, as sustainable resource use is becoming increasingly important, sludge as a resource bank is gathering more and more attention. Development work is on-going to use sludge as a source for sustainable energy production.

Globally increasing drinking water production and increasing investments in wastewater treatment plants also result in growing volumes of sludge. With tightening environmental legislation and increasing pressure on the efficient utilisation of less space, landfilling will become a non-viable option for sludge disposal. Thus, to allow more efficient and versatile use of sludge, new technologies and management strategies are needed.

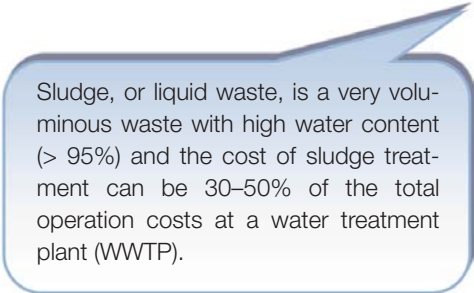

Sludge, or liquid waste, is a very voluminous waste with high water content (> 95%) and the cost of sludge treatment can be 30–50% of the total operation costs at a water treatment plant (WWTP).

The three main future goals in sludge management are to:

1. reduce the amount of sludge that is produced and address the way it is processed
2. maximise energy production from sludge
3. transform sludge into marketable products.

The first important step for the productisation of sludge and more efficient water recycling is cost- and energy-efficient dewatering of sludge. In addition to dewatering methods, research on sludge and concentrates at VTT focuses on the recovery of nutrients and metals from municipal and industrial sludges, and the enhancement of biogas generation from organic sludge.

Reduction of sludge volumes

Today, municipal wastewater treatment plants (WWTPs) usually base their operations on a combination of mechanical and biological processes. The most typical treatment process is the activated sludge process. The heart of such a process is the aerated basin in which suspended micro-organisms

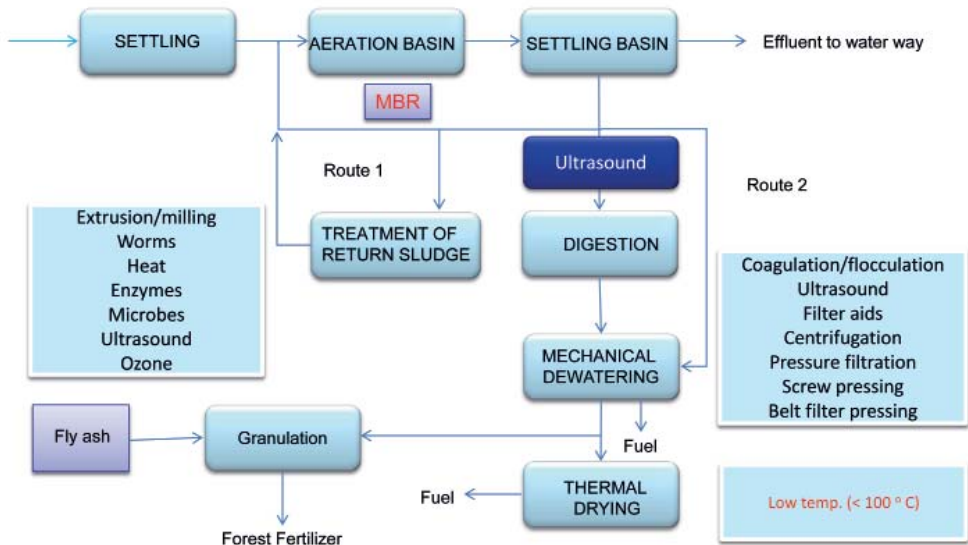

Figure 1. Possible means for reduction and further utilisation of activated sludge from a wastewater treatment plant (WWTP).

remove the organic matter from the wastewater by either consuming it for energy and hence reproduction or by oxidising it to CO₂. A portion of the microbial biomass is recirculated in the process (return sludge) but a part of it must be removed from the water stream as excess sludge and directed to hygienisation as indicated in the process shown in Figure 1.

The amount of excess sludge from a traditional WWTP is voluminous, and has significant disposal costs. However, through internal process modifications in the wastewater treatment plant, sludge reduction can be obtained through two routes. One route is to disintegrate part of the microbes in the return sludge and to further use that part as easily available nutrients for the microbes in the aeration basin (route 1 in Figure 1). This results in enhanced organic removal process and a higher proportion of sludge recycled back into the process. The second route is to increase the dry matter content in the excess sludge which is taken out of WWTP by efficient dewatering (route 2 in Figure 1).

Applying dewatering techniques to algae suspensions

Techniques developed and studied at VTT for enhanced dewatering include several pre-treatment methods such as coagulation, flocculation, mechanical disintegration, enzymes, and bio-based filter aids. Depending on the research question, mechanical dewatering is performed using different pilot and laboratory scale pressers and filters, centrifuges, dryers and evaporators.

VTT know-how on sludge dewatering techniques has recently been harnessed for the processing of a new topical water containing material: algae suspension from microalgae cultivation. Algae biomass – an example of a dilute voluminous biomass – is one of the sources for third-generation biofuels (advanced biofuels or green hydrocarbons) which are globally under broad development work.

The algae biomass is produced by cultivating microalgae suspension in a cultivation pond. The concentration of the dilute microalgae suspension is the first and relatively energy-consuming step in the biodiesel pro-

Membrane bioreactor MBR

- A water treatment technology that produces lower amount of sludge compared to conventional activated sludge based methods.
- MBR-technique enables a WWTP to operate with a smaller carbon footprint compared to a conventional waste water treatment plant.
- The purified effluent water is also cleaner thanks to ultrafiltration used as a part of MBR-technique.
- Membrane bioreactors are potential solutions for removal of persistent pollutants that are not eliminated in the activated sludge process.
- VTT operated a pilot membrane bioreactor throughout 2011. The study focused on enhancing a municipal MBR-process using water chemicals manufactured by Kemira Oyj.

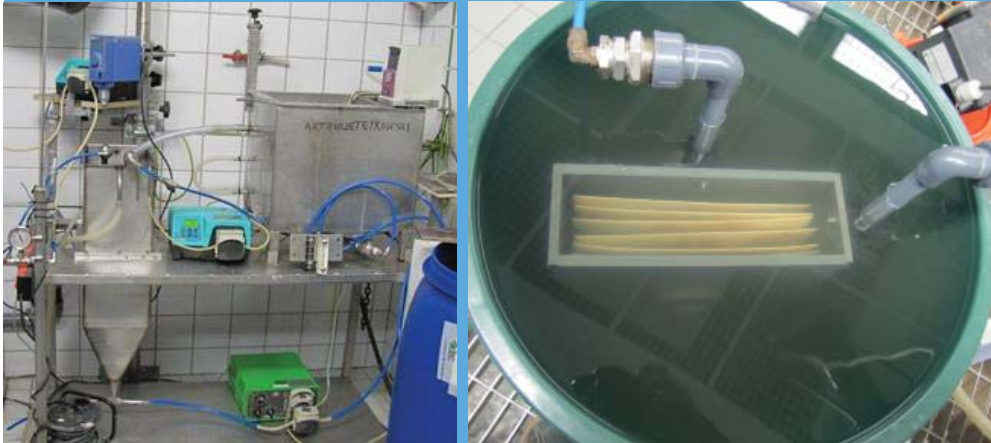

VTT's membrane bioreactor purifying municipal wastewater from Jyväskylä WWTP. The MBR plant uses a flat sheet ultrafiltration membrane module and treats 250 l/d of wastewater.

duction process. A mechanical concentration process for microalgae suspension has been developed at VTT together with Kemira Oyj, whose coagulants and flocculants were utilised in different process stages. The concentration concept is based on combining conventional separation units. Examples of outcomes of different process steps are depicted in Figure 8. Through this concept the algae suspension was efficiently concentrated from the original dry matter level of 0.1% to a dry matter level of 10–20%.

Cost efficient energy production and utilisation from sludge

Excess sludge from a wastewater treatment plant can either be incinerated, landfilled, or used in agriculture as fertiliser or soil amendment. However, before further use it must be hygienised or stabilised. One common method used to stabilise the excess sludge is through anaerobic digestion producing biogas. However, usually the treatment process is not optimised for producing energy. Increasing demand for carbon neutrality and

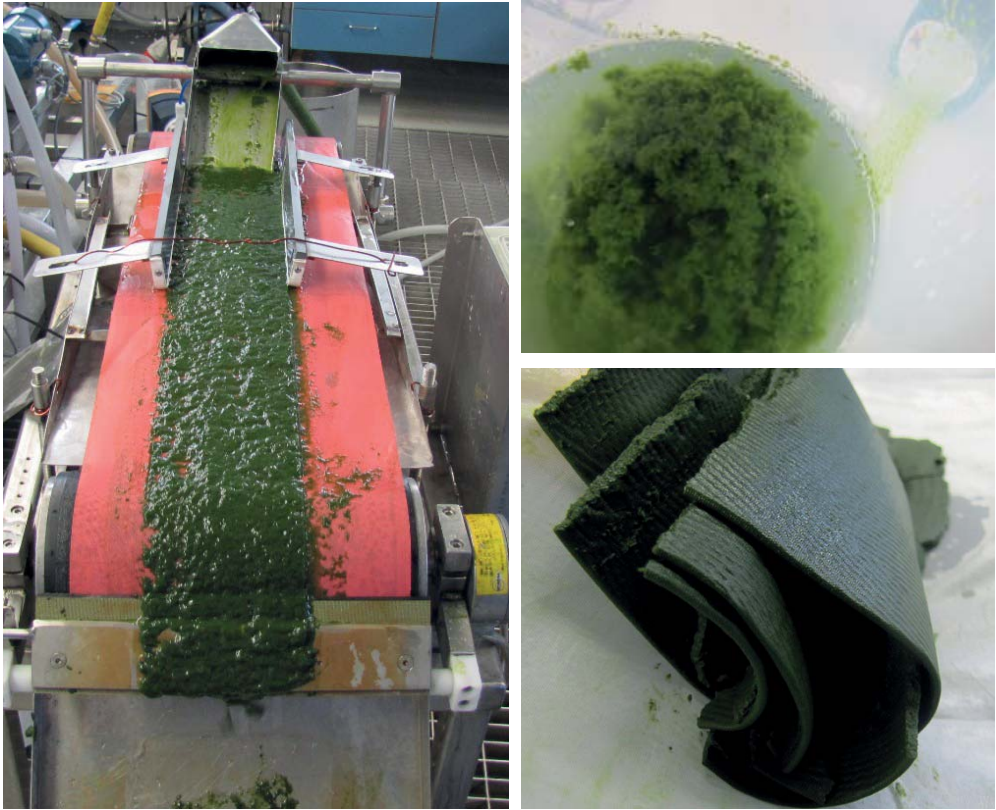

Figure 2. Outcomes of different process steps in the concentration of algae suspension.

cost efficiency necessitate a systemic overview of all costs and emissions occurring in the overall sludge treatment process and increase the pressure to optimise the system for producing energy.

VTT calculated the energy balances, greenhouse gas (GHG) emissions and costs of using anaerobic digestion (AD) and incineration as wastewater sludge treatment methods. Process and cost data from an existing medium-scale Finnish municipal wastewater treatment plant (100,000 person equivalents, 1120 t sludge/day) were used. The study included several options for the utilisation of produced biogas; in a boiler for heat, in a gas engine for electricity, and upgradation to vehicle fuel. In addition, the possibility of enhancing biogas production by increasing the temperature in the AD digester

to the range of thermophilic digestion was studied.

Energy and GHG balances from biogas originating from sludge stabilisation

In options where all biogas is fed to a gas engine with spill heat recovery, the lowest GHG emissions and the optimal production and use of energy was achieved. Placing an emphasis on heat production does not give added value since it is difficult for the wastewater treatment plant to find a use for this excess heat. In the options where all biogas is upgraded and used as vehicle fuel, the internal energy demand must be covered by external energy.

When studying the use of anaerobic digestion as a sludge stabilising method, biogas to electricity was the most feasible option in light

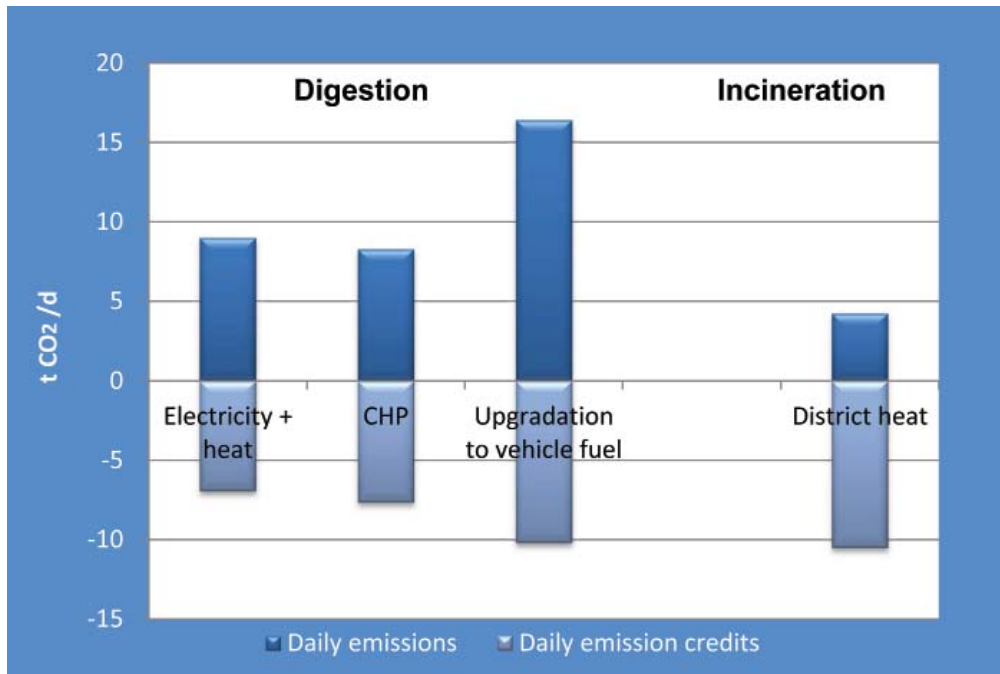

Figure 3. Greenhouse gas emission balances related to studied sludge treatment processes (anaerobic digestion, incineration) and the utilisation of the produced energy.

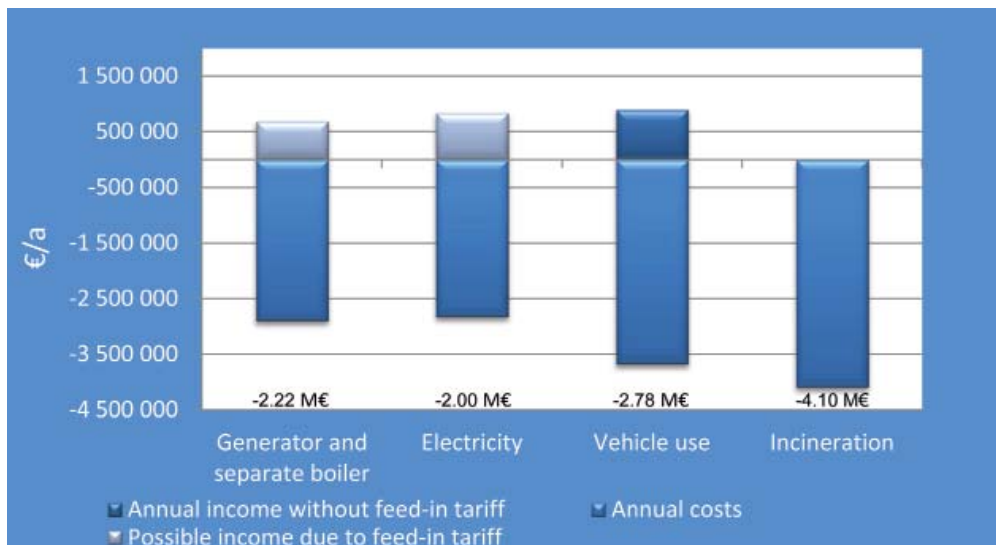

Figure 4. Overall cost of the studied sludge treatment processes. Analysis included all costs from wastewater aeration and chemical usage, through sludge processing to final disposal.

of GHG emissions. Incineration, on the other hand, generated lower GHG emissions in this case, since a centralised, large waste incineration plant can efficiently utilise the produced energy (Figure 3).

Economic feasibility of sludge stabilisation biogas

A summary of the costs and revenues related to the anaerobic digestion and incineration options is given in Figure 4. From an economic point of view the most favourable is the digestion and utilisation of all biogas for electricity production. The favourable position of maximised electricity production is emphasised with a potential feed-in tariff.

Upgrading the produced biogas and selling the biomethane as vehicle fuel to a third party implies increased revenues to the WWTP. However, the attractiveness of this option is reduced by the fact that all the heat and electricity used by the WWTP must be purchased. The increased revenues do not fully cover the increased annual costs.

Thermophilic anaerobic digestion can be an option to enhance the economy of a WWTP, provided that the biogas yield is sufficiently high compared to a mesophilic process. The thermophilic process requires significantly more heat energy, but the increased energy consumption can be covered by an improved gas yield. Based on pilot studies conducted in cooperation with Finnish Environment Institute, thermophilic digestion did not persistently produce more biogas. Thus its impact on GHG emissions – through increased production of renewable energy – was not proven here.

Cost calculations show that the financial break-even point for thermophilic digestion would be achieved with a ca. 40% higher biogas yield compared to the normal mesophilic process. With a feed-in tariff, the break-even point is lower but it depends strongly on the tariff level as well as the price of electricity. With the Finnish biogas tariff the break-even point was 25% improved biogas generation.

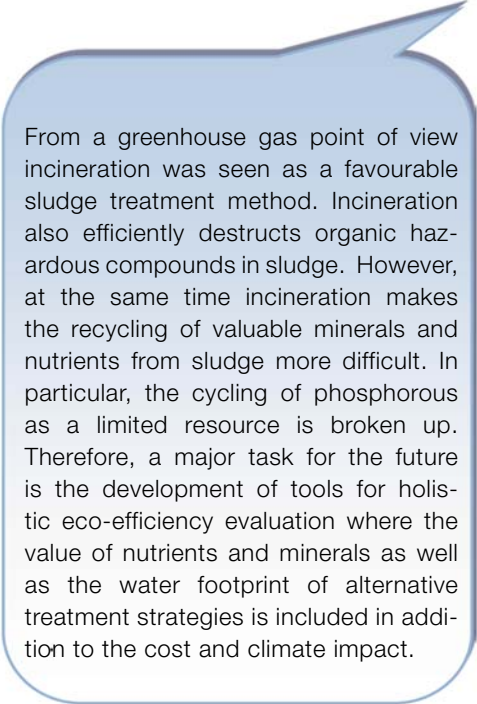

From a greenhouse gas point of view incineration was seen as a favourable sludge treatment method. Incineration also efficiently destructs organic hazardous compounds in sludge. However, at the same time incineration makes the recycling of valuable minerals and nutrients from sludge more difficult. In particular, the cycling of phosphorous as a limited resource is broken up. Therefore, a major task for the future is the development of tools for holistic eco-efficiency evaluation where the value of nutrients and minerals as well as the water footprint of alternative treatment strategies is included in addition to the cost and climate impact.

However, one drawback with thermophilic digestion, influencing the related costs, is the risk of increased siloxane concentration in the generated gas and the subsequent need for additional purification of biogas when it is utilised in gas engines. Thermophilic processes also resulted in more odorous sludge.

Concluding remarks

All parts of the chains of sludge treatment processes that were compared are linked to each other and the choice of one process part option affects the potential of consequent process options. Considering both carbon footprint and revenue streams for the WWTP, the most favourable utilisation of biogas is connected to the need for internal energy at the WWTP. When the WWTP include processes with a high need for electricity, it is most beneficial to maximise on-site electricity production using biogas.

The calculated greenhouse gas balances did not include any substitution credits based on using recycled digestate products (compost, thermally dried sludge) instead of

commercial chemical based fertilisers. Based on literature, it is still unclear, which proportion of the sludge nutrients could be utilised by plants in fertiliser use. Furthermore, a proportion of sludge carbon can be sequestered in soil and enhancing further CO₂ uptake by soil but there is limited information on this process.



Contact at VTT:

PENTTI PIRKONEN
Senior Scientist
pentti.pirkonen@vtt.fi
+358 40 500 6173

Faster and more economic monitoring tools for water quality assessment

Contributing authors:

Liisa Hakola, Jani Kiuru, Maria Smolander

Water monitoring is traditionally linked to assessing whether the quality of effluent and natural waters is compliant with environmental legislation or to assure officials and users of drinking water quality. In addition to monitoring water quality, the increasing amount of harmful substances released into waterways and soil create a need to monitor environmental parameters to protect all forms of life from exposure to hazardous chemicals and to avoid their passing into food chains. Therefore, it is not surprising that Frost & Sullivan have forecasted environmental monitoring to be among the top end user applications of sensors in 2020¹. Some application areas for water quality monitoring concepts according to their report are presented in Table 1.

Challenges in water quality monitoring

Increasing incentives for closing water loops have led to a growing need for monitoring within industrial establishments for the optimisation and process control of their water recycling systems. Often in industrial establishments, the quality of water needs to be continuously verified at the water source, during the use of the water and at end-of-use. In Western countries, there are rarely severe problems with drinking water quality and hence monitoring research and development is focused on industrial and municipal wastewaters as well as recreational waters.

Current monitoring and detection techniques are based on, for example, optical, acoustic, electromagnetic, electrochemical

and chemical methods. Important performance metrics for detection and sensing systems are high sensitivity, specificity, selectivity or wide detection range, and a low number of false alarms. Conventionally, water quality is measured by analysing samples in the laboratory where the analysis typically takes a minimum of two days. In many cases, there is a need for more rapid tests that can be performed at onsite locations. For single organic pollutants in particular, there are no easy-to-use, cheap and rapid test devices currently available. The availability of such portable and fast assay methods for field conditions would be useful for quality control, protection and evaluation purposes.

In the aquatic environment today, there are more and more certain kinds of harmful or even toxic chemicals originating from, for example, pharmaceuticals, pesticides, flame retardants and plasticisers. These chemicals include endocrine disruptors, which interfere with the endocrine system (the gland system in humans and animals) and may produce adverse developmental, reproductive, neurological and immune effects. Phthalates, parabens and bisphenol are particularly harmful for human beings. Rapid onsite tests would facilitate the quantification and the definition of the possible source of the endocrine disruptors.

In recreational waters, an increasing environmental hazard is represented by toxic cyanobacteria, which are commonly encountered nowadays. Hepatotoxic and

¹ Frost & Sullivan 50th Anniversary: 50 Predictions for 50.

Table 1. Application areas for water quality monitoring concepts according to Frost & Sullivan ².

Application area for water monitoring	Examples of target analytes to be monitored
Drinking water	<ul style="list-style-type: none"> - Microbiological quality (early warning detection of accidental and attentional contamination) - Pollutants, micropollutants, toxins, odorous metabolites
Ground water	<ul style="list-style-type: none"> - Pollutant (NO₃ etc) , micropollutants
Raw water (from lakes and rivers)	<ul style="list-style-type: none"> - Toxic and odorous compounds producing cyanobacteria
Water for industrial use and recycled water	<ul style="list-style-type: none"> - Microbiological quality - Corrosion control - Toxicity
Recreational water	<ul style="list-style-type: none"> - Toxic cyanobacteria - Microbial quality
Wastewater treatment performance	<ul style="list-style-type: none"> - Phenolic substances - Endocrine disruptors - Ecotoxicity
Process monitoring	<ul style="list-style-type: none"> - Anaerobic processes - Sulphate reducing bacteria - Odour producing bacteria

neurotoxic blooms occur worldwide in freshwaters and are a health risk for human beings. For example, in the Baltic Sea hepatotoxic water blooms occur every summer and have caused a number of animal poisonings. According to EU legislation, the monitoring of cyanobacteria in recreational waters is based on visual assessment. However, the availability of rapid onsite tests would result in more reliable and frequent analysis results.

Miniaturised lab-on-chip concepts for water quality assessment

Conventional rapid-type tests contain several phases and a lot of manual operation is needed (Figure 1). Lab-on-chip type devices on the other hand can offer a notably faster way of analysing samples. A liquid sample – even just a single droplet – is placed on the device. The sample travels through the

device, which then presents the analysis result as numerical data or a visual colour change. This type of test reduces the need for manual operation and significantly shortens the time required for analysis.

Mass-manufacturing methods, such as printing and injection moulding, are ideal for the cost reduction of manufacturing monitoring solutions. Adding innovations exploiting micro-fluidistics to novel mass-manufacturing methods further enables the development of new kinds of lab-on-chip concepts. There is ongoing research at VTT in close cooperation with the industry to develop test concepts for water quality assessment that are novel, low-cost, miniaturized, fast and specific, by combining manufacturing technologies – printing and injection moulding – with biological and chemical detection of certain impurities and pollutants from water. Research and devel-

² Frost & Sullivan, D1EB-TI, June 2010.

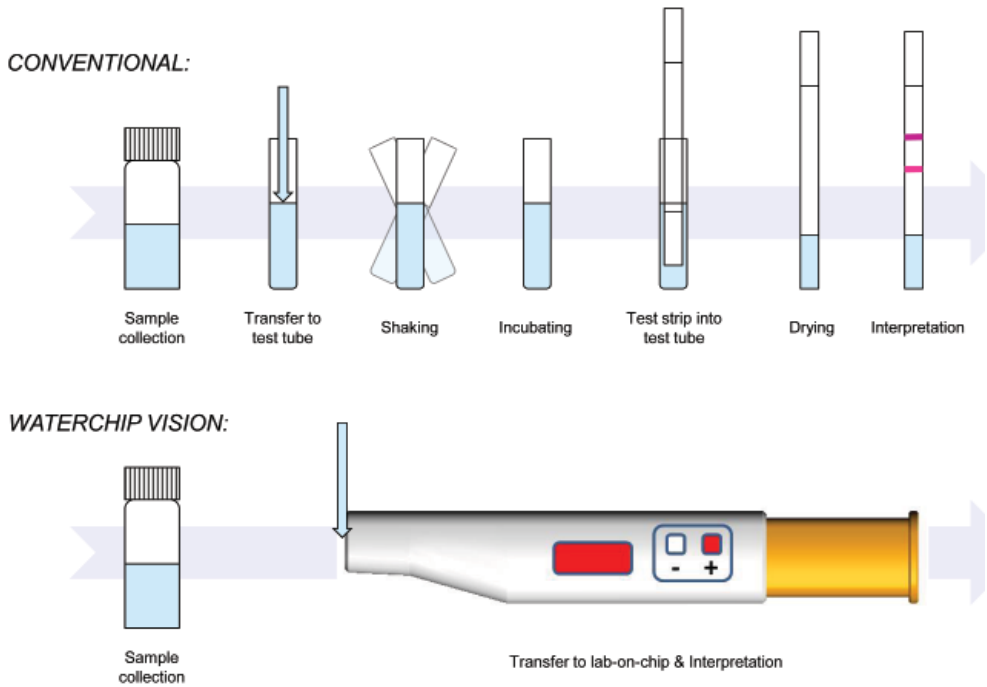

Figure 1. Conventional rapid test principle for water quality analysis and the proposed concept. The duration of the conventional process from sample collection to interpretation is at least one hour, while the proposed method based on the lab-on-chip concept would provide analysis results within few minutes without manual operation.

opment actions are also taking place within sensing chemistries and their integration to sensor and indicator concepts realised by mass-manufacturing techniques.

Some of the concepts will be taken into proof-of-concept at the demonstrator level. The chosen demonstrators are phenol indicators based on 4-aminoantipyrine and microfluidic chips for the detection of blue algae toxins. The demonstrators will focus on the detection and sample preparation process. Actual miniaturised chips will be designed and tested. The phenol indicator will consist of injection moulded chip with reagents inside. Adding water sample will result in reagent mixing thus providing visual colour change. The blue algae toxins sensor will be a hot embossed microfluidic chip. Water sample reacts with antibody and

produces detectable signal such as visual colour change.

In addition to demonstrators, the research and development focus is targeted at two applications:

- detection of toxic and odorous cyanobacteria
- detection of chlorophenols based on enzymatic detection.

Handheld instruments as trouble shooting tools for the needs of the process industry

A new approach for short delay time diagnostic measurements (online or at-line) based on miniaturised instrumentation technology has been developed at VTT to serve the process industry. The new service is intended for aqueous processes and focuses on concurrent

testing with new and faster measuring devices that can be used either online or at-line.

Traditional process in-line sensors constitute fixed, real-time measuring equipment, but their fixed installation generates some restrictions. For example, process optimisation and troubleshooting may require additional data not provided by the routine process control. For this purpose, VTT assembled a set of inexpensive instruments to form an easily transferable and adaptable field laboratory for point-of-need use. For the industry, the ability to quickly address and solve problems is essential in order to maintain process runnability and to minimise the resulting costs.

The portable field laboratory has been set up during a research and development project between partners from the pulp and paper industry and VTT. The value for the partner companies is twofold. First, additional references for existing basic measurements can now be easily and cost-efficiently obtained as measurement equipment can be added to non-instrumented positions for additional data. Second, the study generated a set of new measurements, which have not been traditionally used in the process industry (some examples are listed below). All these applications can easily be packaged to a measurement portfolio for tailored purposes. The philosophy and technologies were tested in several industrial process cases.

Qualities of VTT's portable field laboratory to facilitate decision-making:

- ATP content measurement using a portable luminometer is an easy-to-use method to evaluate microbial activity. Within one day, it is possible to map the performance of a biocide system. Based on the results, it is possible to draw conclusions, take corrective actions and monitor the effect of the actions.
- Ion-selective electrodes (ISE) measuring halogen and ammonium content are useful tools for detecting biocide residues. In

combination with the ATP content, these can be used for optimising biocide consumption and performance.

- The measurement of dissolved calcium amount using ion selective electrode (ISE) is a unique method for filler dissolution monitoring and control, especially in neutral and alkaline papermaking.
- Online measurement of high consistency, high pressure samples is enabled through the application development of ceramic filtration and a thick stock sampling device.
- Optical measurements were utilised for dissolved oxygen measurement and measurement of colloidal turbidity. The latter is closely linked to the colloidal charge.
- Multi-parameter probes are economical, because they can measure several parameters simultaneously online and store the data in an internal memory. Measurable parameters in these probes are pH, conductivity, redox potential, dissolved oxygen and temperature.

Case study: reducing biocide costs

As an example, the conditions within paper mills, that is, an aquatic environment, a temperature of 30–60°C, and a pH range of 4.5–9.0, offer an ideal environment for microbes to grow and reproduce. Traditional tools to evaluate microbial activity within an aqueous process are troublesome and time-consuming. Results can be seen only after approximately two days from the sampling. A portable luminometer measuring the ATP content (ATP adenosine triphosphate) proved to be a very useful and rapid method for estimating the microbial activity within the process. Two paper mill cases showed that by using this method, it is possible to map the biocide system used to limit or eliminate microbial activity in one to two days, and to draw conclusions, take corrective actions, and monitor the effect of the actions. As an informative example, the performance of two different bio-

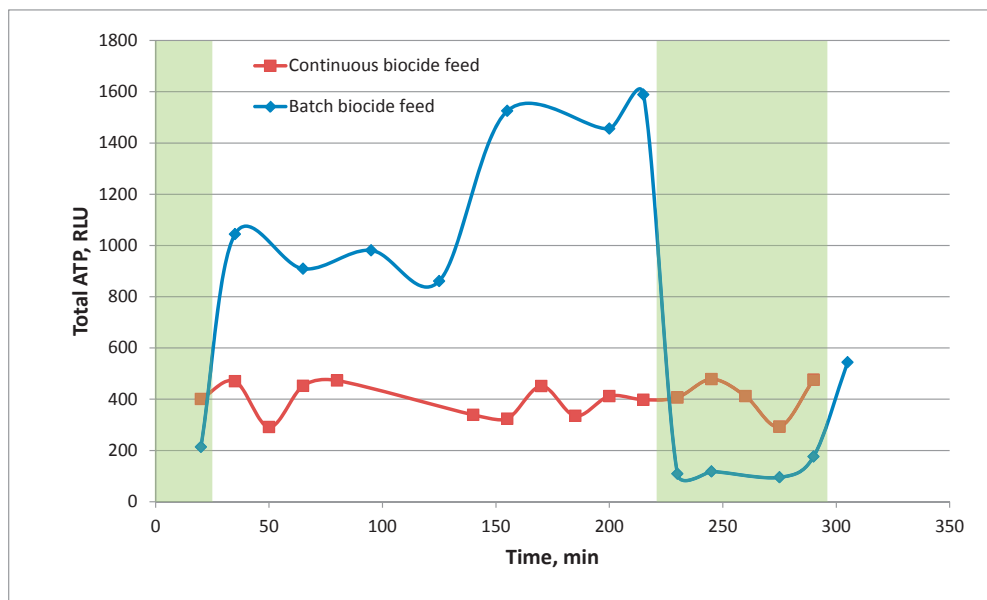

Figure 2. Analysis of the ATP content used to compare different biocide strategies in paper mills. The darker green line represents the ATP content within the process when biocide is added to the process in batches, and the lighter green represents ATP content with continuous biocide feed. The green background colouring represents the dosing periods of biocide in batch mode. It can be seen that monitoring the ATP content effectively reflects the impact of different biocide strategies on microbial activity.

cide strategies employed at the same mill is presented based on the ATP content measurement results (Figure 2).

Analysis of the ATP content using a portable device is very useful and easy-to-use. In combination with dosing data and process online parameters, it can be used for optimising biocide usage. For detecting biocide residues, ion-selective electrode methods sensitive for ammonium and halogen ions were applied.



Contact at VTT:

KIRSI TAPPURA
Principal Scientist
kirsi.tappura@vtt.fi
+358 40 704 1773

Mining in the organic waste mountains

Contributing authors:

Craig Faulds, Raija Lantto, Anna-Stiina Jääskeläinen, Lauri Kuutti, Vidar Grönberg

The public and private sectors generate large amounts of organic waste and side streams deriving from animal, plant, fish and fowl origins. But what should be done with this material? Use it as low cost animal feed and throw the surplus away? Incinerate as a low cost energy source for industry? Much of the material is produced in a wet state and so it cannot be kept for too long as it will degrade and emit bad odours and potentially harmful gases. But the initial material generated costs for the producer, so could we earn anything back from these residues or use it for something else? Figures have shown that annual food waste generation alone in the European Union (EU27) amounts to approximately 89 million tons (Mt), or 179 kg per capita. This amount is growing. In 2010, the EU produced 285.2 Mt of cereals, 58 Mt of vegetables and 36 Mt of fresh fruit (Eurostat). Up to half of this will end up as waste or by-products. A bleak future filled with mountains of rotting organic waste will only be avoided if we understand the threats and make use of possible new technologies to address the problems.

However, there is good news! Within this material, a wide range of potentially high value compounds are contained: protein, carbohydrate, oils and fats, polyphenolics and small organic acids, and minerals, which can be used as food ingredients or may form the precursors for the chemical industries. We can use it, but first we need to find effective ways to access it – to mine it.

Solution concept – organic waste refinery

VTT focuses on unlocking these potential product streams for the benefit of both producers and end users. Our competencies range from the use of novel and current enzymes and biocatalysts in different environmental applications, biomass utilisation, fractionation and subsequent product separation from the laboratory scale to pilot and commercial trials. This aids customers in converting their waste into novel and functional natural raw material and in minimising the amount of the final waste, whilst stimulating technology development in the manufacturing community. The value-chain thus links the producer with the end user. Our concept, the Organic Waste Refinery, develops novel and robust processes that could ultimately provide a range of sustainable platform chemicals for utilisation in low- to high-value product ranges, tailored for the customer and the requirements of a new bio-economy (Figure 1).

The development of the Organic Waste Refinery concept has included the following issues:

- Developing specific biocatalysts (enzymatic and microbial) tailored for the diversity of the waste stream in order to modify and reuse the amount of organic waste.
- Developing software to identify and characterize organic waste “hotspots”, including the establishment and maintenance of a Europe-wide database on biomass side streams.
- Translating this technology to industry.

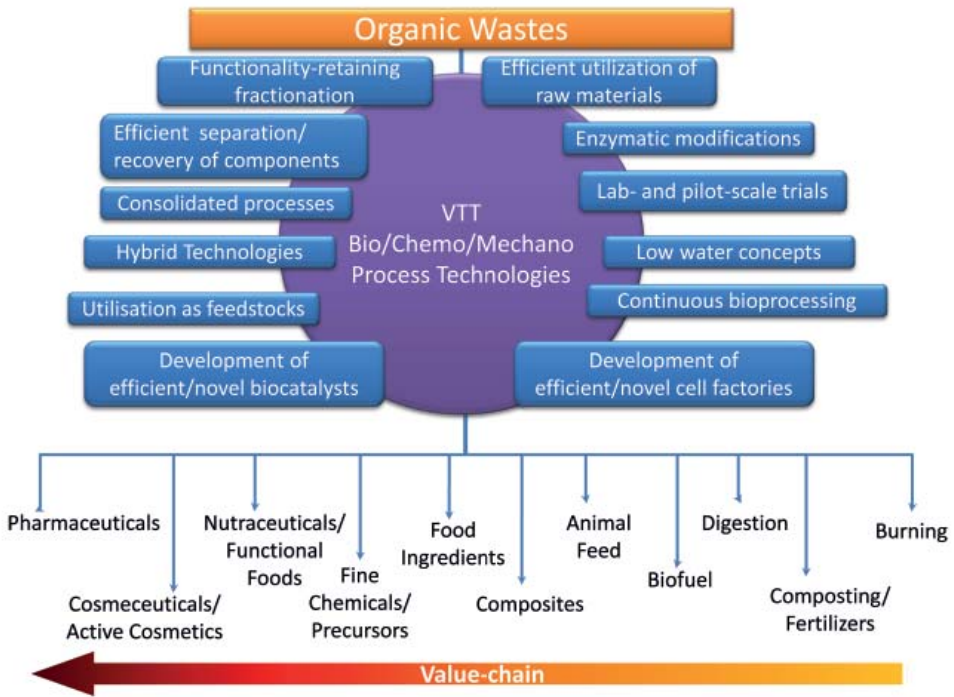

Figure 1. Potential value chains from organic waste that could be established through developing tailored processes to extract selected components from agro-industrial wastes and by-products.

Making the most of side and co-streams

Mapping our wastes

The SideStream 2010 computer program has been developed to organise European industry by-product waste data in the form of a database. Five out of ten input variables describe the type and amount of biomass in dry weight ton produced annually. These variables are the amount of glucose (C6), the amount of other sugars (C5), lignin, lipids and protein. The main idea is to use GPS coordinates to find locations with the greatest potential where producers and users are in relatively close proximity. For example, if we have identified some interesting coordinates on the map and we know the coordinates of the available side stream resources scattered on the map, we can calculate distances between the map

point and each resource. When the distance from a map point to a resource is known, consideration can be limited to resources that are, for example, less than 200 km away from the map point. The total available biomass at a map point is the total amount of biomass contained in resources that are less than 200 km away.

Added value from high protein and oil industrial co-streams

Many co-streams from the food industry are excellent sources of proteins and healthy oils for use in foods and cosmetics. However, at the moment these side streams are mainly used as fish and animal feed, for energy, or end up as waste.

In cooperation with global universities and small and medium sized enterprises (SMEs) VTT seeks to enrich several co-stream

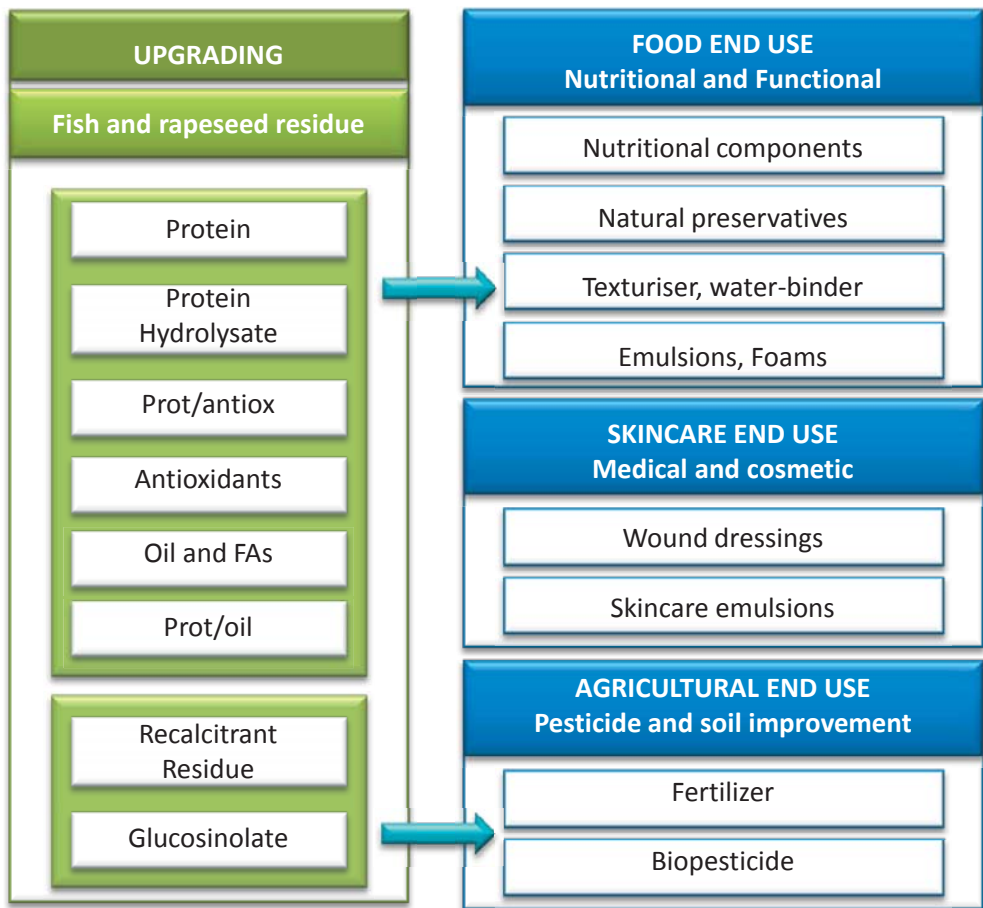

Figure 2. The approach for upgrading fish and rapeseed residue.

components at once from food quality co-streams of rapeseed, canola, mustard and fish. In particular, this project aims to promote the competitiveness of the SME sector and developing regional production units located near primary production.

The biorefinery concept aims at complete exploitation of selected high protein and high oil containing industrial co-streams (fish filleting residue and rapeseed meal) by environmentally benign biomechanical processing technologies to produce value components for food and skin care products and exploit the remaining residue for soil improvement and bio-pesticide use.

The chosen sidestreams are suitable for the production of a multitude of value-added food and cosmetic components, such as medicinal skin care products where soy and animal protein can be replaced with rapeseed or fish derived protein.

Processing technologies combine mechanical and enzymatic process steps replacing chemicals with enzymes and focusing at reduction of water consumption and organic solvent usage. Lenient enzymatic treatment minimizes changes in the protein and prevents oxidation of the wanted lipid components.

The approach has the potential to broaden the scope of the business opportuni-

ties for existing fish processing industry and rapeseed oil pressers, but also for new industry aiming at developing high-value products from industrial co-streams or waste (Figure 2). Only simple changes in the existing processing are required to convert the present processing of the selected co-streams to a biorefinery, i.e. 1) replacing chemicals currently used to enzymes or 2) adding an enzyme treatment step to existing mechanical processing.

Although the selected side-streams differ from each other, they all contain high concentration of protein, oil, bioactive components and minerals and they provide a valuable biomass source of nutritional components to be added to low-nutrient diets in developing countries and multitude of value-added components for food and skin care formulations such as:

- phenolic antioxidants for food preserving and wound healing
- protein with high nutritional quality
- fish collagen to replace bovine or poultry based analogues in cosmetic and medical skin care formulations
- protein hydrolysates with good digestibility, bioactivity and technological performance for foods
- polyunsaturated fatty acids (PUFAs), phospholipids, and lipid soluble antioxidants and vitamins for nutrition
- minerals (P) for soil improvement
- antinutritive glucosinolates for pesticides.



Contact at VTT:

RAIJA LANTTO
Technology Manager
raija.lantto@vtt.fi
+358 40 727 0703

Counteracting material scarcity

Contributing authors:
Heikki Kukko, Ulla-Maija Mroueh,
Jarno Mäkinen

In the inorganic material industry, two needs in the production and use of inorganic materials are highlighted due to the global trends of economic growth and technical development. First, large waste flows should be used in ways that give more surplus value and techno-economic benefits. Secondly, global scarcity of several raw materials, such as rare earth elements and phosphorus, has been recognised. Moreover the global raw material markets are increasingly distorted by protectionist trade policies, and maintaining fair and undistorted access to these materials is increasingly difficult. There is a strong need to ensure the availability of the scarce materials in the future.

By developing advanced separation techniques, a significant amount of scarce materials can be obtained from the large waste flows. The most potential lies in the waste from the mining industry, since the ore often contains other valuable elements in addition to those that are enriched. Technical challenges lie in the enrichment of valuable components and in the use and development of innovative bio-based methods for that purpose. In order to truly advance the exploitation of waste material, a change of mindset is needed – waste should not only be separated but the interest should be directed to value-adding activity and to classify waste

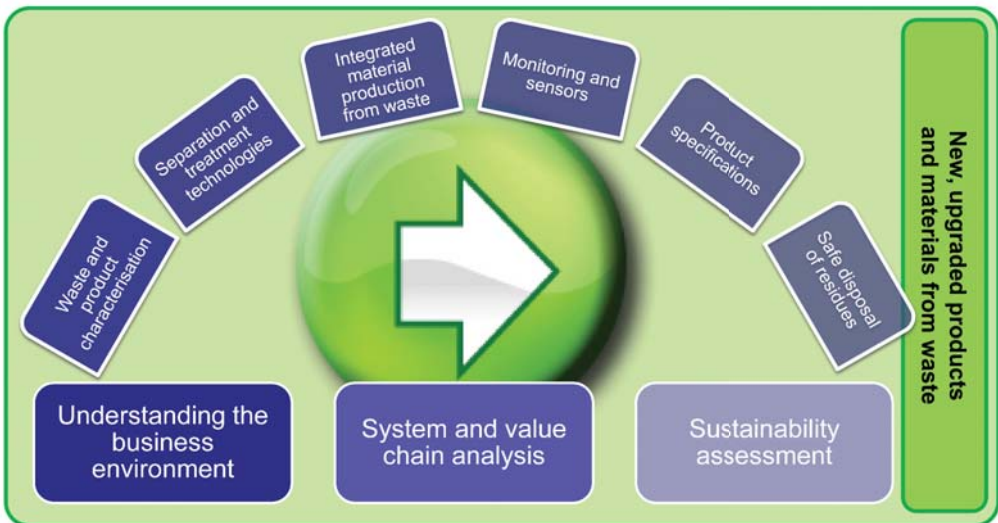

Figure 1. A set of competences needed for counteracting material scarcity through recycling and recovery.

so that its productisation can be promoted. Effective recovery of materials implies that the recycling aspect should be taken into account already in the product's design phase. System analysis involving value chain analysis, collection and logistics are important elements for developing economically sustainable processes (Figure 1). There are also certain materials for which unstable international trade policies make it necessary to develop new sources and the use of substituting materials.

VTT is active in developing the use of large waste flows

The role of large waste flows, such as various ashes from power stations and waste (both liquid and solid) from the mining industry is increasing. The reasons for this development are lack of storage areas for massive waste material and increasing environmental requirements and costs occurring from waste handling. On the other hand, even minor added value through improved refining and logistics offer considerable benefits when volumes are high.

The utilisation of ashes has become more and more complicated in recent years because of the increasing use of various wastes as fuel, and the developments in burning technologies leading to potentially more challenging consistency of the ashes for further use. In this area, VTT has identified the most significant views, factors and drivers affecting the operational environment and future research needs in the area. As an example, ashes from biological origins contain typically a fair amount of unburnt coal making landfilling or utilisation as such in earth construction a difficult option. Fly ashes also contain valuable minerals that can be bioleached and recovered. By sintering and heat treatment activation the ashes could be transformed into a low cost, light-weight aggregate for construction. Also or new solutions for inorganic binders used in concrete is a potential utilisation route.

Mining activity has increased internationally and especially in Finland over the last few years. This emphasises the technical, economic and ecological development need in this area, and VTT has actively participated, for example, in the preparation of the Finnish National Mineral strategy.

Activating international cooperation has been a general topic in the GWW programme. Together with the largest research institutes in Europe (Fraunhofer, CEA, SINTEF, SP, TNO, Tecnalia VTT started a pilot project 'Value from Waste' developing concepts for the recovery of scarce metals and safe management of nanoparticles in waste treatment processes. The work covers the total waste recovery value change combining each partner's particular strengths and complementarities related to identification, separation, enrichment and extraction of scarce metals as well as waste collection. VTT focuses especially through practical work to strengthen current bioleaching expertise and further on the technological potential of recycling of nanomaterials. Phosphorous recovery is again developed together with Australian partners.

Research and development can prevent scarcity of materials

The recovery of critical metals from waste materials has been studied from the point of view of advanced solutions for recycling of complex and previously unrecycled materials. This work has been supported by a separate study on electronic waste as a resource for critical metals. In recent research projects at VTT it has become clear that along with processing technology, the logistics of waste collection and handling are of critical importance to create a sound economic basis for recovery activities. It is noteworthy in this topic area that various industrial clusters, from electronics to building and construction companies are cooperating with VTT for non-field-specific development.

Bioleaching – a promising technology for extracting minerals from waste

An example of a process with industrial importance and validity is the development of bioleaching. In the mining industry the method is already in large-scale use, but its possibilities are still wide-ranging. An example of ongoing development work is its use for extracting valuable minerals from waste.

Solid waste streams from the mining and metallurgy, energy production and recycling industries may contain relatively high levels of metals that are harmful if released into the environment. These waste streams can be considered potentially valuable sources of metals. Traditionally, metals have been solubilised from solid waste materials in chemical leaching processes with strong acids. However, these methods are favourable only when recoverable metals are present at relatively high levels. Bioleaching is an alternative treatment method for those solid waste materials that have relatively low levels of valuable metals, or if the material is otherwise difficult to handle or treat. Bioleaching as a technique utilizes certain acidophilic iron and sulphur oxidizing bacteria. In certain conditions these microbes can be enriched in a bioleaching system, which causes massive production of ferric iron and sulphuric acid. These substances are working as fierce leaching chemicals against many different minerals. Due to oxidation of mineral, also metals are solubilised out of the matrix. At this stage, biologically produced sulphuric acid has turned bioleaching system to highly acidic and metals remain in solution, ready to be recovered later in the process.

Final slag is formed as a by-product of copper smelting. In Finland alone 350,000 tonnes are produced annually and currently, the majority is disposed in landfill. It is estimated that if the copper content of the slag could be recovered it would consist of 1.2% of the annual production of copper and around 10% of the copper produced by the largest copper mine in Finland. Moreover, the amount of iron in final slag would replace 4% of the annual iron production in Finland.

The leaching of the final slag has been evaluated. The results from VTT's experiments in the laboratory and in pilot-scale have demonstrated that metals can be bioleached from final slag. Metal solubilisation yields for the final slag averaged 30–80%, depending on the test conditions. The highest metal recoveries were achieved in experiments supplemented with elemental sulphur at pH 1.0 and 0.5. Copper and nickel were solubilised almost completely, while zinc yields varied between 30–60%.

The annual production and high metal-content of final slag makes it a material with exceptionally high potential for waste valorisation. Combinations with other metallurgical technologies should be tested for optimal process economics. This work is continuing.

Advanced technologies for the enrichment of scarce metals are developing and new, leaner raw materials and wastes are becoming affordable. For effective development, the combination of various expertise is needed, e.g. mineralogy and phase analytics, knowledge in processing methods and modelling tools as well as modelling and monitoring expertise.

Scarcity of materials has become a topic of international discussion for several reasons:

- New technologies use increasing amounts of rare earth elements and platinum group metals.
- Ecological development in the use of renewable energy production, electric mobile appliances and vehicles need these elements.
- More efficient and durable products and processing tools depend on high tech materials.
- Unevenly distributed natural reserves and unstable international trade policies make it necessary to develop new sources of these materials and the use of substitute materials.



Contact at VTT:

ULLA-MAIJA MROUEH
Principal Scientist
ulla-maija.mroueh@vtt.fi
+358 40 526 1449

New business concepts based on integrated valorisation of waste streams

Contributing authors:

Ulla-Maija Mroueh, Laura Sokka

The concern about the availability of raw materials, energy and water is reflected in ambitious political resource efficiency targets. This thinking is presented in the European Waste and Energy Efficiency Directive, as well as in economic measures, such as rising costs of landfill disposal. These issues are bound to impact on current business models and may cause some of them to become unviable. Integrating value-adding activity and functions to waste streams can provide some answers for mature businesses.

Future improvements of material efficiency, together with the radical minimisation of resource wastage, are strongly emphasised in the Roadmap to a Resource Efficient Europe, published in 2011. The international influence of European legislation through global business actions is also generally recognised.

Challenges in forming closed material cycles

The new targets require a transition towards closed cycles, and call for a change from the current fragmented thinking towards a better understanding of complex technical, environmental and social entities and for a substantial increase in cross-sector collaboration. The importance of integrated resource efficiency (material, energy, water) and holistic thinking is growing. This is reflected both in the need for integrated technology solutions as well as in the need for assessment models supporting business and societal decisions in the rapidly-changing business environment. One

of the challenges is that instead of supporting the closing of material cycles, in many cases research and development produces materials, components and products that are actually difficult to recycle. The introduction of smart design concepts and decision support tools that enable the transition towards a reusing and recycling society can significantly improve resource efficiency and even create totally new business concepts.

New business opportunities should also be seen within the risks related to the availability of materials currently in danger of scarcity, as they stimulate the development of substitute materials and advanced recovery solutions covering entire value chains.

Industrial symbiosis concepts require fresh thinking and transdisciplinary innovations

In general, the main objective of industrial symbiosis concepts is to minimise inefficiencies and the amount of waste created in society¹. In VTT's research on industrial symbiosis concepts, processes and industries are seen as interacting systems and research aims at developing sustainable and cost-effective integrated solutions, which will change the material and energy losses of industrial and societal activities into viable business. The focus is on the identification and development of:

- new integrated material and energy recovery concepts combining the exploitation of industrial and municipal waste and side streams

¹ Harper E & Graedel T 2004 'Industrial ecology: a teenager's progress', *Technology in Society*, 26: 433–45.

- value chain and networking concepts for recycling and recovery of materials from waste flows
- concepts for integrated water, material and energy efficiency of mines and for the life cycle management of the environmental impacts of mines
- modelling and measuring concepts for the evaluation of systemic changes.

In this complicated, multi-technological and cross-scientific research area, the exploitation and adaptation of VTT's various technological competencies is an important prerequisite for success. VTT's transdisciplinary approach enables proceeding from concept identification and evaluation to technology development needed in practical industrial applications, and further to piloting. Just to mention a few examples, know-how on recycling, fractionation and characterisation methods, chemistry and biotechnology, energy and process technologies as well as monitoring technologies is available and applied to R&D activities within VTT. Electronics and IT competencies and smart applications can also be applied to strengthen industrial symbiosis, reuse and recycling.

In addition to the innovative combination of technological competencies, the design of integrated solutions is based on the analysis of the sustainability, technical and business potential of the solutions in the changing operational environment. Modelling and measurement concepts are developed for better understanding and forecasting of the impacts of systemic changes. Various sustainability analysis tools, such as Life Cycle Assessment (LCA), Life Cycle Cost assessment (LCC), carbon and water footprint, material flow analysis, energy efficiency analysis, and combinations of them are one cornerstone of this assessment. The combination of sustainability analysis tools with system dynamic and process modelling, scenario analysis and foresight and business competence creates a

strong basis for the development of cost and eco effective solutions.

Case study of industrial symbiosis in forest industry

Life Cycle Assessment and other sustainability assessment methods have quite generally been used for the evaluation of the potential environmental impacts in technology development projects. An extensive investigation of the environmental life cycle impacts of an industrial symbiosis concept based on pulp and paper production was carried out at VTT in a dissertation published in 2011². It was one of the first studies where all the life cycle stages from raw material extraction and production to the waste management of an industrial symbiosis were analysed. The case was also compared to four hypothetical reference scenarios, where the actors worked on their own in order to study whether industrial symbiosis produced environmental benefits compared to the hypothetical scenarios.

Most of the environmental impacts of the symbiosis case were smaller than those of the reference scenarios. This was mainly due to changes in the way energy was produced. It was concluded that based on this case, it is possible both to produce economic benefits and to reduce the environmental impacts of industrial symbiosis based on pulp and paper production. The results also showed that the environmental impacts caused by the extraction and processing of the materials and the energy used by the symbiosis were considerable, and therefore all the life cycle stages should be studied. Industrial symbiosis should be seen as part of the process of improving the environmental performance of a system .

Examples from analysis of waste value chains

Municipal waste and construction and demolition waste value chains have been analysed to identify their most important development targets, and to analyse selected new tech-

² Sokka, L. Local systems, global impacts. Using life cycle assessment to analyse the potential and constraints of industrial symbioses. Doctoral dissertation. VTT Publications 768. VTT Technical Research Centre of Finland, Espoo, 2011. 71 p. + app. 76 p.

nological developments for their life cycle environmental impacts, costs and technical potential.

One example of the several studies made is the analysis of the environmental and cost aspects of pneumatic waste collection system of municipal waste in a selected case study area. It was carried out in collaboration with the University of Helsinki and several producers and potential users of such pneumatic systems. The aim was to analyse the benefits and potential constraints of integrating the system into an existing city infrastructure. The Punavuori area of Helsinki was chosen as a case study area, and the system was also compared with the prevailing container collection system. In general, the pneumatic system has many benefits. The integration into an existing system is, however, clearly more challenging than construction in a new area.

The environmental impacts of both waste collection methods were compared based on a life cycle inventory. It was concluded that in the Punavuori case, the pneumatic waste collection system creates more greenhouse gas and nitrogen oxide emissions than conventional systems. This is mainly due to the high electricity consumption of both the pneumatic collection and the manufacturing of system components. On the other hand, at the local level the emissions reduce because of traffic reduction. The system also has the potential to increase the safety and hygiene levels of waste collection. Especially in new areas, the pneumatic collection may save space for buildings or other activities.

The results of the study cannot be generalised for all cases, because issues such as population density and properties of the system affect the results of the comparison.

A holistic analysis of the material flows and the environmental and cost efficiency of the MSW and C&D value chains was also carried out. Based on these studies and the analysis of drivers, markets and potential future developments of the operational environment, the

most important development needs in these chains have been highlighted, and the potential of further industrial development projects is currently being analysed.



Contact at VTT:

OLLI SALMI
Research Professor
olli.salmi@vtt.fi
+358 40 734 2154

Related publications

- Arnold, M. & Merta, E.** Towards energy self-sufficiency in wastewater treatment by optimized sludge treatment. *Water Practice & Technology*, 6(4). IWA Publishing 2011. doi: 10.2166/wpt.2011.0069
- Gaál, G., Kaija, J., Baker, J., Cassard, D., D'Hugues, S.P., Grundfelt, B., Ehinger, S., Kurylak, W., Mizera, W., Sarlin, J., Spiteri, A. & Weihed, P.** A new approach to mineral resources in Europe – ProMine. International Conference on Sustainable Production and Consumption of Mineral Resources – Integrating the EU's Social Agenda and Resource Efficiency. Wroclaw, Poland, 20 – 22 October 2011. Pp. 131–142.
- Harlin, A., Blomberg, P., Räsänen, L., Shan, J., Koukkari, P., Tapper, U. & Sarlin, J.** Routes to produce nanomaterials using acid mine drainage waters. International Conference on Sustainable Production and Consumption of Mineral Resources – Integrating the EU's Social Agenda and Resource Efficiency. Wroclaw, Poland, 20–22 October 2011. Pp. 205–213.
- Järvelä, E., Ihalainen, J., Grönberg, V. & Jääskeläinen, A.S.** Concentration of the dilute tannin solution using forward osmosis process (poster). Euromembrane. London, UK, 23–27 September 2012.
- Kaksonen, A.H., Lavonen, L., Kuusenaho, M., Kollari, A., Närhi, H., Vestola, E., Puhakka, J.A. & Tuovinen, O.H.** Bioleaching and recovery of metals from final slag waste of the copper smelting industry. *Minerals Engineering*, 24(11), 2011, pp. 1113–1121. doi: 10.1016/j.mineng. 2011.02.011
- Kapanen, A., Vikman, M., Lehtonen, A. & Itävaara, M.** The influence of the carrier material on the microbial diversity in packed-bed biofilm reactors. IWA Biofilm Conference 2011. Processes in Biofilms. Tongji University, Shanghai, China, 27–30 October 2011.
- Kiuru, J., Peltosaari, A. & Wathén, R.** Reviewing the potential of hand-held sensors as performance indicators for wet end chemistry. *IPW - The magazine for the international pulp and paper industry*, 1, 2011, pp. 17–23.
- Korpijärvi, K., Ryymin, R., Saarno, T., Reinikainen, M. & Räsänen, M.** Recycling of ashes from co-combustion of peat and wood – case study of a modern CFB-boiler. Proceedings of International Nordic Bioenergy. Jyväskylä, Finland, 5–9 September 2011. 8 p.
- Kurola, J.M., Arnold, M., Kontro, M.H., Talves, M., & Romantschuk, M.** Wood ash for application in municipal biowaste composting. *Bioresource Technology*, 102, 2011, pp. 5214–5220.
- Kyllönen, H., Järvelä, E. & Martikainen, P.** A view to antiscalant dosing in RO membrane filtration. Proceedings in SIWW, Singapore International Water Week, 4–7 July 2011.
- Maunuksela, L., Torniainen, M., Kapanen, A., Vikman, M. & Laine, M.** Applicability of biogas plant end-products as organic fertilizers. ACSEE – The Asian Conference on Sustainability, Energy and the Environment. Osaka, Japan, 2–5 June, 2011.
- Nikkola, J., Mannila, J. & Nättinen, K.** Use of atmospheric plasma in modification of polyolefin surfaces. *Membrane Science and Technology MST2011*. Nanyang Technological University, Singapore, 23–26 August, 2011.
- Nyman, K. & Hakala, T.** Decolorization of ink jet inks with laccase mediator system during pulp deinking. *BioResources*, 6(2), 2011, pp. 1336–1350.
- Raulio, M., Juvonen, R., Alakomi, H.L., Ekman, J., Hesampour, M. & Lundin, T.** Characterisation of (bio) fouling on used reverse osmosis membranes (poster). Euromembrane. London, UK, 23–27 September, 2012.
- Sokka, L.** Local systems, global impacts. Using life cycle assessment to analyse the potential and

constraints of industrial symbioses. Doctoral dissertation. VTT Publications 768. VTT Technical Research Centre of Finland, Espoo, 2011. 71 p. + app. 76 p

Vepsäläinen, M., Kivisaari, H., Pulliainen, M., Oikari, A. & Sillanpää, M. Removal of toxic pollutants from pulp mill effluents by electrocoagulation. *Separation and Purification Technology*, 81(2), 2011, pp. 141–150.

Vikman, M., Saario, E., Kapanen, A. & Itävaara, M. Microbial diversity and nitrate removal efficacy in small-scale gray water treatment units. 12th Nordic Wastewater Conference. Marina Congress Center, Helsinki, Finland, 14–16 November, 2011.

Virtanen, H., Boer, H. & Smolander, M. Development of printable indicators and sensors containing oxidoreductase enzymes (poster). OxiZymes, Marseille, France, 16–19 September, 2012.



Series title and number
VTT Research Highlights 4

Title	Research highlights in Green solutions for water and waste
Author(s)	Kaisa Belloni (ed.)
Abstract	Green Solutions for Water and Waste is one of VTT's Spearhead Programmes that has been running since 2011. This publication presents some of the research highlights from the first half of the programme. Focal areas of this programme have been water treatment technologies and waste management. In water treatment the research has focused in enzyme and membrane technologies and membrane surface treatment methods, water monitoring technologies, and sludge treatment. Regarding waste treatment methods and technologies the focus has been in refining organic waste and conceptualising new business on valorisation of waste streams.
ISBN, ISSN	ISBN 978-951-38-7964-8 (Soft back ed.) ISBN 978-951-38-7965-5 (URL: http://www.vtt.fi/publications/index.jsp) ISSN-L 2242-1173 ISSN 2242-1173 (Print) ISSN 2242-1181 (Online)
Date	March 2013
Language	English
Pages	48 p.
Keywords	water treatment, waste management, micropollutants, water monitoring, sludge, organic waste, waste value chain
Publisher	VTT Technical Research Centre of Finland P.O. Box 1000 FI-02044 VTT, Finland Tel. +358 20 722 111

VTT Technical Research Centre of Finland is a globally networked multitechnological contract research organization. VTT provides high-end technology solutions, research and innovation services. We enhance our customers' competitiveness, thereby creating prerequisites for society's sustainable development, employment, and wellbeing.

Turnover: EUR 290 million

Personnel: 3,100

VTT publications

VTT employees publish their research results in Finnish and foreign scientific journals, trade periodicals and publication series, in books, in conference papers, in patents and in VTT's own publication series. The VTT publication series are VTT Visions, VTT Science, VTT Technology and VTT Research Highlights. About 100 high-quality scientific and professional publications are released in these series each year. All the publications are released in electronic format and most of them also in print.

VTT Visions

This series contains future visions and foresights on technological, societal and business topics that VTT considers important. It is aimed primarily at decision-makers and experts in companies and in public administration.

VTT Science

This series showcases VTT's scientific expertise and features doctoral dissertations and other peer-reviewed publications. It is aimed primarily at researchers and the scientific community.

VTT Technology

This series features the outcomes of public research projects, technology and market reviews, literature reviews, manuals and papers from conferences organised by VTT. It is aimed at professionals, developers and practical users.

VTT Research Highlights

This series presents summaries of recent research results, solutions and impacts in selected VTT research areas. Its target group consists of customers, decision-makers and collaborators.

Green Solutions for Water and Waste

Water scarcity and the sustainable use of materials are global challenges that require new innovative processes and technologies.

The principles of ecological efficiency and sustainability are strong drivers for a sustainable industry and society. Business in the field of environmental technology is growing rapidly and supports the progress towards zero emission processes.

The vision of VTT spearhead programme Green Solutions for Water and Waste (GWW) is to create technological stepping stones towards a zero emission society using our internationally recognised competence.

Central technologies in GWW are energy efficient water purification and reuse, recovery of valuable compounds from waste and side streams and new waste recycling processes. Focus is on developing membrane technologies, recovery of critical minerals and new waste derived products. Sustainability and efficiency are ensured with new monitoring and data management tools.

The strength of the programme is to broadly integrate the competence in different technological sectors to create innovative solutions.

The main beneficiaries of the GWW spearhead programme are the domestic and international environmental, process- and technology industries. The goal of the programme is to create new cross cutting technological solutions to support the development of a sustainable industry and society.

ISBN 978-951-38-7964-8 (Soft back ed.)

ISBN 978-951-38-7965-5 (URL: <http://www.vtt.fi/publications/index.jsp>)

ISSN-L 2242-1173

ISSN 2242-1173 (Print)

ISSN 2242-1181 (Online)

