



The implementation of BIM within the public procurement

A model-based approach for the construction industry

Marzia Bolpagni

VTT TECHNOLOGY 130

The implementation of BIM within the public procurement

A model-based approach for the construction
industry

Marzia Bolpagni



ISBN 978-951-38-8058-3 (URL: <http://www.vtt.fi/publications/index.jsp>)

VTT Technology 130

ISSN-L 2242-1211

ISSN 2242-122X (Online)

Copyright © VTT 2013

JULKAISIJA – UTGIVARE – PUBLISHER

VTT

PL 1000 (Tekniikantie 4 A, Espoo)

02044 VTT

Puh. 020 722 111, faksi 020 722 7001

VTT

PB 1000 (Teknikvägen 4 A, Esbo)

FI-02044 VTT

Tfn +358 20 722 111, telefax +358 20 722 7001

VTT Technical Research Centre of Finland

P.O. Box 1000 (Tekniikantie 4 A, Espoo)

FI-02044 VTT, Finland

Tel. +358 20 722 111, fax + 358 20 722 7001

The implementation of BIM within the public procurement

A model-based approach for the construction industry

L'utilizzo del BIM negli Appalti Pubblici. Un Approccio basato sulla Modellazione Digitale per il Settore Edile / Tietomallin käyttö julkisissa hankinnoissa. BIM-pohjainen lähestymistapa rakennusteollisuudelle.

Marzia Bolpagni. Espoo 2013. VTT Technology 130. 233 p.

Abstract

Recently more and more Public Sectors have been paying close attention to save cost and, at the same time, improve efficiency. Usually, the Construction Industry has a relevant annual turnover, which represents an important part of the GDP for most of the EU countries and concerns in a large part the Public Sector. Thus, some Public Clients, such as UK, are adopting new strategies in order to improve the current situation. One of these strategies is Building Information Modelling (BIM), which forces all the parties involved in the process to adopt a collaborative approach reducing inefficiencies. Moreover, also the European Parliament is going to encourage the BIM adoption to 'modernise the procurement process and ensure greater efficiencies'. The EU Directive will be an important push to reform the EU Members' Public Construction Procurement.

The aim of this M. Sc. Thesis is to analyse the possible implementation of BIM within the Public Procurement, especially how Model Checking can be applied within Tendering to verify the compliance between the Client's requirements and the bid's contents.

The first part presents both the most widespread Public Procurement Methods, such as Design-Bid-Build (DBB), Design-Build (DB), Construction Management (CM), Design-Build-Operate (DBO) and Design-Build-Finance-Operate (DBFO), as well as innovative kinds of Procurement Procedures, such as Integrated Project Delivery (IPD), Project Alliancing (PA), Cost Led Procurement (CLP), Integrated Project Insurance (IPI), Two Stage Open Book and Early BIM Partnering (EBP). A paragraph is dedicated to the drivers and the barriers of e-Procurement, which should be part of the Public Procurement strategy. Later, the main issues related to BIM are shown, such as current BIM Authorised Uses and Permitted Purposes, Interoperability and OpenBIM, along with BIM implementation in Public Sector of several countries (Singapore, USA, Finland, UK, Norway, Denmark, Netherlands, South Korea, Hong Kong, Australia, New Zealand, Iceland, Estonia, Sweden, Germany, China, Ireland, Taiwan and Italy) and the relation between e-Procurement and BIM. Additionally, the principal possibilities and challenges dealing with BIM adoption are presented. The following chapter is dedicated to the investigation of the possible BIM implementation in Tendering. Even if integrated procedures, such as IPD, seem to be the most suitable with BIM, a discussion of the BIM role in DBB and DB or Design Competitions is carried out, showing the main Client's requirements, benefits for Bidders and Clients, together with limitations and possibilities. Thereafter, a paragraph illustrates Model Checking in the evaluation of design proposals. First, a short description of the main commercial software, which can support BIM-based tendering (such as Solibri Model Checker (SMC), EDM Model Server, dRofus, Affinity, dProfiler, Autodesk NavisWorks, Tekla BIMsight, Bentley Projectwise Navigator, Riuska, Autodesk Ecotect, EasyBIM, Vico Cost Planner and Mitchell Brandtman) is provided. Later, a list of the most common operations, which nowadays

a Client could check in a BIM tender together with the main commercial software available, is shown. More emphasis has been given to the software SMC, since this study was mostly carried out testing it and some new rules have been created. Moreover, a comparison between the published version of Statsbygg Building Information Modelling Manual and the translated rule-sets in SMC is carried out to understand the possibilities and limitations of the software in order to check Client's requirements. Another paragraph describes five case studies presented in literature to investigate the possible implementation of BIM in Tendering (cluster of University Buildings in Denmark, National Museum at Vestbanen in Oslo, Synergy Building in Helsinki, Office and Shopping Space in Canada and prison Cookham Wood in Rochester). Finally, the possible implementation of BIM in Tendering is tested on an Italian case study, a Theatre in Rimini, and a simulation of e-Tendering, adopting i-Faber e-Procurement platform, is investigated.

This study shows that nowadays BIM, and especially Model Checking, can be a useful support for Public Construction Procurement only if the Public Clients hold the control of the process and they are able to define clear requirements.

Keywords Building Information Modelling (BIM), Public Procurement Methods, Tendering, Model Checking, e-Procurement

L'utilizzo del BIM negli Appalti Pubblici

Un Approccio basato sulla Modellazione Digitale per il Settore Edile

The implementation of BIM within the public procurement. A model-based approach for the construction industry / Tietomallin käyttö julkisissa hankinnoissa. BIM-pohjainen lähestymistapa rakennusteollisuudelle.

Marzia Bolpagni. Espoo 2013. VTT Technology 130. 233 p.

Abstract

Ultimamente nel Settore Pubblico si assiste a un'attenzione sempre più accesa nel contenere le spese così come nella ricerca di processi più efficienti. Ogni anno il Settore delle Costruzioni, e in particolar modo il Settore Pubblico, registra un importante giro d'affari che costituisce buona parte del PIL di molte stati europei. Per questo motivo alcuni Governi, come quello britannico, stanno sviluppando nuove strategie per migliorare i processi tradizionali. Una di queste strategie è il Building Information Modelling (BIM), che spinge tutte le parti coinvolte nel processo ad adottare un atteggiamento collaborativo riducendo le inefficienze. Il Parlamento Europeo, inoltre, ha intenzione di incoraggiarne l'utilizzo per modernizzare l'iter degli appalti e garantire una maggiore efficienza. La direttiva europea sarà un importante stimolo per rinnovare gli Appalti Pubblici degli Stati Membri.

Lo scopo di questa Tesi è analizzare l'utilizzo del BIM negli Appalti Pubblici e, in particolare, studiare come il Model Checking, cioè la verifica di modelli BIM, possa essere applicato in fase di gara per verificare la conformità delle proposte dei concorrenti rispetto alle richieste della committenza.

Un primo capitolo è dedicato agli appalti pubblici di lavori più diffusi come l'appalto di sola esecuzione (DBB), appalti integrati (DB), contratti di concessione (DBO e DBFO) e Construction Management. Accanto a queste tipologie sono presentati anche alcuni approcci innovativi come l'Integrated Project Delivery (IPD), Project Alliancing (PA), Cost Led Procurement (CLP), Integrated Project Insurance (IPI), Two Stage Open Book ed Early BIM Partnering (EBP). Un paragrafo presenta i principali aspetti legati agli Appalti Elettronici (e-Procurement), che dovrebbero rientrare nelle strategie delle stazioni appaltanti. Il capitolo successivo descrive le principali caratteristiche del BIM come la sua storia, i campi di applicazione, l'interoperabilità e l'OpenBIM, oltre al suo sviluppo in diversi paesi (Singapore, USA, Finlandia, Regno Unito, Norvegia, Danimarca, Olanda, Corea del Sud, Hong Kong, Australia, Nuova Zelanda, Islanda, Estonia, Svezia, Germania, Cina, Irlanda, Taiwan e Italia) e al legame tra e-Procurement e BIM. Inoltre, sono discussi le principali potenzialità e limiti legati all'implementazione del BIM. Il capitolo seguente studia come il BIM potrebbe essere utilizzato in fase di gara. Sebbene approcci integrati, come l'IPD, siano più vantaggiosi in presenza di un processo BIM, in questa sede sono analizzati i casi più tradizionali di appalti di sola esecuzione (DBB), appalti integrati (DBB) e concorsi di architettura. Particolare attenzione è data alle esigenze dei committenti, ai vantaggi per i concorrenti e i committenti e alle potenzialità e limitazioni di questo approccio. In seguito, un paragrafo illustra il ruolo del Model Checking all'interno della valutazione delle offerte presentando i principali software disponibili sul mercato (come Solibri Model Checker (SMC), EDM Model Server, dRofus, Affinity, dProfiler, Autodesk NavisWorks, Tekla BIMsight, Bentley Projectwise

Navigator, Riuska, Autodesk Ecotect, EasyBIM, Vico Cost Planner e Mitchell Brandtman). Inoltre, sono studiate le principali operazioni che una stazione appaltante può compiere per verificare la conformità delle offerte e i principali software disponibili, soffermandosi principalmente su SMC, con il quale sono stati eseguiti dei test e create nuove regole. Per meglio comprendere le potenzialità e criticità di SMC nel tradurre in rulesets regole scritte, si è comparata la versione cartacea del manuale BIM di Statsbygg con il relativo set di regole (rulesets) presente SMC. Il paragrafo successivo illustra cinque casi di studio presenti in letteratura dove il BIM è stato utilizzato in fase di gara (Stabili Universitari in Danimarca, Museo Nazionale a Oslo, Edificio a Helsinki, Uffici e Spazi commerciali in Canada e prigione Cookham Wood a Rochester). Infine, l'utilizzo del BIM in fase di gara è stato implementato su un progetto italiano, il teatro Galli di Rimini, e si è utilizzata la piattaforma di e-Procurement per la pubblica amministrazione di i-Faber.

Questo studio rivela che il BIM, e in particolar modo gli strumenti di Model Checking, possono essere fin da ora un valido supporto per gli Appalti Pubblici di lavori solo se le stazioni appaltanti detengono il controllo del processo e impostano la gara in modo chiaro e dettagliato.

Parole chiave Building Information Modelling (BIM), Appalti Pubblici di lavori, Fase di gara, Model Checking, Appalti Elettronici

Tietomallin käyttö julkisissa hankinnoissa

BIM-pohjainen lähestymistapa rakennusteollisuudelle

The implementation of BIM within the public procurement. A model-based approach for the construction industry / L'utilizzo del BIM negli Appalti Pubblici. Un Approccio basato sulla Modellazione Digitale per il Settore Edile.

Marzia Bolpagni. Espoo 2013. VTT Technology 130. 233 s.

Tiivistelmä

Julkinen sektori on viime aikoina alkanut kiinnittää yhä enemmän huomiota kustannusten säästämiseen ja samalla tehokkuuden parantamiseen. Rakennusteollisuuden tuotannon arvo on tärkeä osa bruttokansantuotetta (BKT) useimmissa EU-maissa, ja merkittävä osa siitä muodostuu julkiselta sektorilta. Tästä syystä rakentamisen julkiset tilaajat esimerkiksi Ison-Britanniassa kehittävät uusia strategioita nykyisen tilanteen parantamiseksi. Yksi näistä strategioista on rakentamisen tietomallinnus (Building Information Modelling, BIM), joka pakottaa kaikki prosessin osapuolet omaksumaan yhteistyöhön perustuvan työskentelytavan, joka vähentää tehottomuutta. Lisäksi myös Euroopan parlamentti tulee kannustamaan tietomallien käyttöönottoon "hankitaprosessien nykyaikaistamiseksi ja tehokkuuden lisäämiseksi". Kyseinen EU-direktiivi tulee olemaan tärkeä aloite EU:n jäsenmaiden julkisen rakentamisen hankintojen uudistamiseksi.

Tämän opinnäytetyön tavoitteena on analysoida tietomallin (BIM) mahdollista käyttöä julkisissa hankinnoissa, erityisesti miten BIM-pohjaista mallin tarkistamista voidaan käyttää tarjousvaiheessa tilaajan vaatimusten ja ehdotusten sisällön vastaavuuden varmistamiseen.

Ensin esitetään yleisimmin käytetyt julkiset hankintamenetelmät, kuten perinteinen hankintamenetelmä (Design-Bid-Build DBB), suunnittelu-toteutus (Design-Build DB), projektinjohto (Construction Management CM), elinkaarimallit (Design-Build-Operate DBO ja Design-Build-Finance-Operate DBFO) sekä uusia innovatiivisia hankintamenetelyjä, kuten Integrated Project Delivery (IPD), Project Alliancing (PA), Cost Led Procurement (CLP), Integrated Project Insurance (IPI), Two Stage Open Book ja Early BIM Partnering (EBP). Yksi luku keskittyy sähköisen hankinnan "draivereihin" ja esteisiin, joiden tulisi olla mukana julkisten hankintojen strategiassa. Tämän jälkeen esitetään tietomalleihin liittyvät keskeiset kysymykset, kuten mallien nykyinen käyttö, yhteensopivuus ja "OpenBIM", BIMin käyttöönotto julkisella sektorilla eri maissa (Singapore, USA, Suomi, Iso-Britannia, Norja, Tanska, Hollanti, Etelä-Korea, Hongkong, Australia, Uusi-Seelanti, Islanti, Viro, Ruotsi, Saksa, Kiina, Irlanti, Taiwan ja Italia) sekä sähköisen hankinnan ja tietomallien välinen yhteys. Lisäksi käsitellään tietomallien käyttöön ottoon liittyvät tärkeimmät mahdollisuudet ja haasteet. Seuraava luku käsittelee tietomallien mahdollista käyttöä tarjouskilpailuissa. Vaikka yhteistyöhön perustuvat menettelyt, kuten IPD, näyttävät olevan sopivin sopimusmalli tietomallia hyödyntävissä hankkeissa, keskustellaan tietomallin roolista perinteisessä (DBB) ja suunnittelu-toteutus (DB) -hankkeissa sekä suunnittelukilpailuissa. Tuloksina esitetään tietomallien käyttöön liittyvät tilaajan tärkeimmät vaatimukset sekä hyödyt tarjoajille ja tilaajalle, yhdessä mallin käyttöön liittyvien rajoitteiden ja mahdollisuuksien kanssa. Tämän jälkeen omassa luvussaan havainnollistetaan mallin tarkistamista suunnitelmaehdotusten arvioinnissa. Ensin kuvataan lyhyesti tärkeimmät kaupalliset ohjelmistot, joilla voidaan tukea BIM-

pohjaista tarjouskilpailua (Solibri Model Checker (SMC), EDM Model Server, dRofus, Affinity, dProfiler, Autodesk NavisWorks, Tekla BIMsight, Bentley ProjectWise Navigator, RIUSKA, Autodesk Ecotect, EasyBIM, Vico Cost Planner ja Mitchell Brandtman). Tämän jälkeen esitetään yleisimmät toiminnot, jotka tilaaja voisi nykyisin tarkistaa BIM-pohjaisesta tarjouksesta käyttäen kaupallisia ohjelmistoja. Päähuomio on Solibri Model Checker -ohjelmassa, jota tutkimuksessa pääosin käytettiin testauksiin ja johon luotiin myös joitakin uusia tarkastussääntöjä. Lisäksi työssä on vertailtu Norjan Statsbyggin julkaisemia mallinnusohjeita (Building Information Modelling Manual) ja niitä vastaavia SMC-säännöstöjä, tavoitteena ymmärtää ohjelman mahdollisuuksia ja rajoitteita suunnitelmille tehtävässä tilaajan vaatimustenmukaisuuden tarkistuksessa. Erillisessä luvussa kuvataan viisi esimerkkihanketta, joiden avulla selvitettiin kirjallisuustutkimuksena tietomallin käyttömahdollisuuksia tarjouskilpailuissa (yliopistorakennusten kokonaisuus Tanskassa, National Museum at Vestbanen Oslossa, Synergialato Helsingissä, toimisto ja myymälätoimitila Kanadassa ja vankila Cookham Wood Rochester Englannissa). Lopuksi BIMin käytön mahdollisuuksia on tutkittu Italialaisen Riminin teatterin korjaushankkeen tarjouskilpailussa, ja sähköisen tarjouskilpailun simulointi on toteutettu i-Faber-nimisellä sähköisen hankinnan alustalla.

Avainsanat tietomallinnus, Building Information Modelling (BIM), julkiset hankinnat, tarjousprosessi, mallien tarkastaminen, sähköinen hankinta

Sommario

Capitolo 1 – Introduzione

Il primo capitolo riveste una funzione introduttiva, in quanto presenta il contesto e lo scopo della tesi nonché il metodo utilizzato e la struttura del testo.

Nel mondo delle costruzioni, soprattutto nel settore pubblico, la fase di gara assume un ruolo determinante nell'ambito dell'intero processo di realizzazione di un'opera. Troppo spesso però la documentazione di gara, esclusivamente bidimensionale, è errata o incompleta e si generano così ritardi e contenziosi che aumentano i costi dell'opera. Per cercare di risolvere i problemi legati al metodo bidimensionale, sta emergendo nel settore edile un nuovo approccio chiamato Building Information Modeling (BIM).

Questa tesi ha lo scopo di indagare in primo luogo i problemi legati alle procedure attuali e successivamente studiare come il BIM e gli strumenti di verifica di modelli BIM (Model Checking) possano essere utilizzati per selezionare il miglior concorrente. Inizialmente, si è analizzato il materiale presente in letteratura riguardante diverse tipologie di appalto pubblico e il BIM. Questa ricerca si è rivelata utile non solo per introdurre l'argomento, ma anche per analizzare i dati empirici rilevati in una seconda fase dove si sono svolte delle simulazioni e intervistati alcuni esperti sul tema.

Capitolo 2 – Appalti Pubblici

Il secondo capitolo si apre presentando come tradizionalmente viene impostata una gara, per passare poi alle principali tipologie di Appalti Pubblici distinte tra quelle più diffuse e quelle più innovative che stanno emergendo nel settore delle costruzioni. Tra quelle più tradizionali vi sono l'appalto di sola esecuzione (DBB), appalti integrati (DB), contratti di concessione (DBO e DBFO) e il Construction Management. Per ogni caso vengono discussi i vantaggi, gli svantaggi e le possibili varianti al procedimento. Tra gli approcci più innovativi si trovano invece l'Integrated Project Delivery (IPD), Project Alliances (PA), Cost Led Procurement (CLP), Integrated Project Insurance (IPI), Two Stage Open Book e Early BIM Partnering (EBP). Queste nuove tipologie promuovono la collaborazione e un anticipato coinvolgimento della controparte nel processo decisionale.

Il paragrafo successivo si occupa invece dei principali aspetti legati agli appalti elettronici (e-Procurement), la cui diffusione è ancora limitata in Europa ad eccezione di alcuni paesi come il Portogallo. In particolare sono messe in luce le potenzialità e le limitazioni di questa tecnologia, soffermandosi principalmente sulle strategie promosse dall'Unione Europea.

Capitolo 3 – Building Information Modelling

Il seguente capitolo presenta i principali concetti legati al BIM. Dopo averne descritto le finalità e aver presentato una breve storia, vengono illustrati i principali campi di applicazione del BIM (progettazione di edifici, coordinamento tra diverse discipline, produzione di documentazione 2D, visualizzazione e comunicazione, supporto decisionale, controllo qualità, calcolo delle quantità, piano dei lavori, stima dei costi, diversi tipi di analisi, simulazione 4D e supporto alla manutenzione). Si passa poi al tema dell'interoperabilità, discutendo l'importanza di formati neutri chiamati 'open' standards come l'IFC. Quando all'interno di un processo BIM vengono utilizzati open standards, questo prende il nome di 'Open BIM'. L'utilizzo di un approccio Open BIM ben si presta per gli Appalti pubblici, perché la stazione appaltante non è obbligata a utilizzare o imporre specifici software. Il tema dell'interoperabilità rimane uno dei più importanti all'interno dello sviluppo del BIM e gli enti pubblici dovrebbero investire più risorse per promuoverlo. Per meglio comprendere la diffusione del BIM nel settore pubblico, si è analizzata la situazione di diversi paesi (Singapore, USA, Finlandia, Regno Unito, Norvegia, Danimarca, Olanda, Corea del Sud, Hong Kong, Australia, Nuova Zelanda, Islanda, Estonia, Svezia, Germania, Cina, Irlanda, Taiwan e Italia). Inoltre, si sono esaminati gli aspetti salienti dell'implementazione del BIM nel settore pubblico presentando alcuni casi di studio dove, sebbene il governo non abbia reso il BIM obbligatorio, esso è stato utilizzato da alcune 'illuminate' istituzioni o organizzazioni pubbliche.

Un paragrafo descrive inoltre come il BIM possa essere integrato all'e-Procurement, illustrando lo studio portoghese SOA4BIM. Attualmente questo tema è in una fase embrionale e ulteriori ricerche sono necessarie per comprenderlo più a fondo. Si presentano infine i principali benefici e le sfide legate all'utilizzo del BIM per meglio comprenderne i punti di forza e le attuali criticità. Tra i primi si possono ricordare la riduzione di costi, rischi e tempi, un migliore prodotto finale, la promozione della collaborazione e della comunicazione, la facilità nell'apportare modifiche, le informazioni sempre aggiornate e la coerenza dei dati, una maggiore competitività a livello internazionale e il supporto per la prefabbricazione. Le principali criticità e le sfide future riguardano invece l'inerzia culturale degli operatori, lo sforzo formativo, lo sviluppo di Open standards e della tecnologia, la necessità di una singola norma che standardizzi il BIM, l'integrazione tra il BIM e le strategie per la sostenibilità, l'utilizzo di esperienze pregresse sul BIM, la valutazione delle competenze sul BIM, la proprietà intellettuale dei dati, la necessità di nuove forme di contratti, assicurazioni e tipologie di appalti.

Capitolo 4 – Possibile utilizzo del BIM in fase di gara

In questo capitolo viene studiato il ruolo del BIM in fase di gara. Attualmente il BIM viene utilizzato solo raramente per selezionare i partecipanti e valutare le offerte, in quanto solitamente è richiesto in fasi successive all'aggiudicazione. Questa ricerca ha lo scopo di dimostrare che il BIM, grazie a strumenti di Model Checking, può essere un valido supporto anche in fase di gara. Recentemente, è stato avanzato un emendamento alla direttiva europea sugli appalti pubblici per incoraggiare l'utilizzo del BIM al fine di modernizzare l'iter degli appalti e garantire una maggiore efficienza. Quando la direttiva entrerà in vigore, questo sarà un importante stimolo per rinnovare gli Appalti Pubblici degli Stati Membri. A tal proposito è necessaria un'analisi delle potenzialità e delle limitazioni prima di adottare il BIM. Sebbene siano più idonei al BIM approcci che

favoriscano la collaborazione e l'integrazione tra i diversi soggetti coinvolti nel processo come l'IPD, in questa ricerca si è deciso di studiare l'utilizzo del BIM in due casi più tradizionali: appalti di sola esecuzione (DBB), e appalti integrati (DB) e concorsi di architettura. Per entrambi i casi si sono analizzati i doveri della stazione appaltante, i benefici per la stazione appaltante e i concorrenti e le principali criticità e potenzialità. Tra le due tipologie la seconda è risultata quella più vantaggiosa, in quanto consente ai concorrenti di sviluppare il progetto e di trarne maggiori vantaggi.

Il paragrafo successivo descrive più nel dettaglio il ruolo del Model Checking nella valutazione delle offerte. Inizialmente vengono presentati i principali software disponibili sul mercato che possono essere utilizzati da una stazione appaltante per oggettivare la scelta del contraente (Solibri Model Checker (SMC), EDM Model Server, dRofus, Affinity, dProfiler, Autodesk NavisWorks, Tekla BIMsight, Bentley Projectwise Navigator, Riuska, Autodesk Ecotect, EasyBIM, Vico Cost Planner e Mitchell Brandtman). In un secondo momento, si mostrano alcuni esempi dei requisiti che una stazione appaltante può controllare tramite strumenti di Model Checking e i relativi software utilizzabili. I principali criteri riguardano la qualità del modello, l'anonimato dei file, il programma dei nomi, i requisiti sugli spazi come dimensione di aree e volumi e la presenza di arredi, la proprietà degli elementi, le analisi energetiche, il calcolo dei costi, l'accessibilità e la sicurezza. Un altro paragrafo si sofferma poi sull'utilizzo del software SMC dove sono state create nuove regole (rules) e modificate alcune già presenti per soddisfare specifiche richieste del committente. A differenza di altri software di Model Checking, SMC offre la possibilità di personalizzare i parametri delle regole e di fare verifiche non solo geometriche ma anche concettuali (come controllare la presenza di oggetti all'interno degli spazi del modello). Per meglio comprendere le potenzialità e le criticità di SMC nel tradurre in rulesets regole scritte, si è comparata in modo dettagliato la versione cartacea del manuale norvegese BIM di Statsbygg con il relativo set di regole già presente in SMC. Il Model Checking può essere un utile strumento per controllare richieste che presuppongono una risposta chiara e oggettivabile. Per quanto riguarda invece richieste più soggettive come la valutazione della qualità architettonica di un manufatto, questi strumenti non sono indicati perché coinvolgono parametri difficilmente standardizzabili. Il paragrafo successivo illustra cinque casi di studio presenti in letteratura dove il BIM è stato utilizzato in fase di gara (Stabili Universitari in Danimarca, Museo Nazionale a Oslo, Edificio a Helsinki, Uffici e Spazi commerciali in Canada e prigione Cookham Wood a Rochester). Tutti i casi di studio presentano diversi punti di forza, ma ulteriori sviluppi sono richiesti soprattutto nel preparare la documentazione di gara. A causa della poca esperienza, la stazione appaltante non sembra riuscire a cogliere tutti i benefici che il BIM può offrire e spesso lo richiede senza sapere cosa riceverà e come gestirlo.

Infine, l'utilizzo del BIM in fase di gara è stato implementato su un progetto italiano, il teatro Galli di Rimini, modellando diverse tipologie di layout di cantiere e una variante al sistema di impianti di condizionamento dell'aria. In questo modo si è potuto verificare che la visualizzazione 3D aiuta a comprendere l'opera e che il programma SMC può essere un valido supporto per valutare le offerte di diversi concorrenti e controllare che i requisiti contenuti nei documenti di gara vengano rispettati. Tuttavia, questi strumenti non sostituiscono le competenze della giuria data la notevole complessità degli appalti di lavori. Questo caso di studio è stato utilizzato anche per svolgere una simulazione con la piattaforma e-Procurement per la pubblica amministrazione di i-Faber al fine di

comprenderne meglio il funzionamento. La piattaforma semplifica il processo rendendolo più trasparente e oggettivo senza tuttavia coprirne tutte le fasi, in quanto principalmente supporta gli operatori fino all'aggiudicazione della gara. Per questo motivo sono necessari ulteriori sviluppi anche in relazione ad una futura implementazione con strumenti BIM che oggi non sono integrati, come la maggior parte delle piattaforme di e-Procurement presenti sul mercato.

Capitolo 5 – Conclusioni e Futuri Sviluppi

Questo capitolo mostra i risultati a cui si è giunti durante lo sviluppo della tesi e mette in luce gli aspetti per cui sarebbe necessario compiere ulteriori studi.

L'utilizzo del BIM è ancora in una fase embrionale e raramente viene utilizzato dalle stazioni appaltanti per valutare le offerte dei concorrenti. Anche se casi di studio mostrano che il BIM, e in particolare il Model Checking, offrono un valido supporto, gli enti pubblici sembrano non essere ancora pronti per adottare questo processo. Infatti, prima di implementare il BIM in fase di gara è necessario che chi lo richiede sia consapevole dei limiti e delle potenzialità per preparare un'adeguata documentazione. Per questo motivo dovrebbero essere promossi dei progetti di ricerca ed eseguite delle simulazioni prima di integrare il BIM in fase di gara. Solo dopo un approccio graduale il BIM può essere integrato e diventare parte ufficiale degli appalti pubblici di lavori. Inoltre, il BIM è un processo rivoluzionario che richiede un cambiamento non solo a livello tecnologico ma soprattutto culturale, e a tal fine è richiesta la collaborazione tra tutte le parti coinvolte. Per questo motivo, sebbene il BIM possa essere utilizzato in diversi procedimenti, nuove tipologie di appalti come l'IPD dovrebbero essere sviluppate per ottenere migliori risultati. Inoltre, per gestire al meglio un processo BIM sarebbe utile che la stazione appaltante adottasse un'adeguata infrastruttura come EDMS. Come avvenuto recentemente nel Regno Unito, il ruolo del Governo è fondamentale perché lo sviluppo del BIM possa essere promosso in modo efficace. Analizzando la situazione in diversi paesi, infatti, si nota come la sua diffusione sia più estesa dove il Governo ha intrapreso una strategia BIM (come nel Regno Unito), o dove organizzazioni pubbliche ne abbiano promosso l'utilizzo (come in USA, Finlandia, Norvegia e Danimarca). Per questo motivo gli enti pubblici dovrebbero introdurre il BIM anche in fase di gara adottando strumenti di Model Checking che, pur non sostituendo il ruolo della commissione, potrebbero essere un valido supporto decisionale. Un appalto gestito nel modo indicato offrirebbe anche dei benefici per i concorrenti, che potrebbero più facilmente effettuare un'autovalutazione della loro offerta. Questo contribuirebbe anche a evitare l'attuale tendenza di proporre offerte basse sperando di riguadagnare successivamente sulla base di errori contenuti nella documentazione di gara attraverso contenziosi. La competizione sarebbe quindi orientata su altri binari quali una maggiore competitività, trasparenza e maggior qualità dell'opera.

Un altro aspetto importante che gli enti pubblici dovrebbero tenere in considerazione è lo sviluppo del cosiddetto 'Knowledge Management', cioè la gestione del patrimonio informativo di ciascuna commessa con lo scopo di incrementare le prestazioni future. In questo modo le esperienze pregresse potranno essere capitalizzate riducendo errori sistematici e il BIM potrà fornire un utile supporto per raggiungere questo fine. Inoltre, sebbene circa il 19% del PIL degli stati europei sia dovuto ad appalti pubblici di beni, servizi e lavori, solo una piccola parte è compresa all'interno della Direttiva europea. Per questo motivo, è necessario apportare delle modifiche per creare un mercato eu-

ropeo più forte aumentando la competizione dei partecipanti. Nuove tecnologie, come gli appalti elettronici, possono aiutare a rafforzare la trasparenza del processo e a favorire la partecipazione di altri stati europei. Sebbene sin da ora gli appalti elettronici di lavori possano contribuire a migliorare il processo, il loro sviluppo è assai limitato rispetto a quello di beni e servizi a causa di una maggiore complessità. Per questo motivo sono necessarie ulteriori ricerche per comprendere come integrare pienamente gli appalti di lavori all'interno di piattaforme di appalti elettronici e per studiare come il BIM possa essere implementato nel processo.

Alla luce di quanto detto, il margine di miglioramento in fase di gara nel settore delle costruzioni è assai ampio e il BIM ha delle grosse potenzialità per migliorare l'intero processo. Il settore pubblico deve essere più determinato nell'abbracciare nuove strategie per abbandonare gli errori sistematici del passato ed entrare in un futuro più efficiente.

Acknowledgements

I would like to express my gratitude to Professor Angelo Luigi Camillo Ciribini, Supervisor of this M. Sc. Thesis, who has outlined the subject of the work and has carefully followed my research both in Italy and during my stay in Finland. His knowledge and command over the subject has helped me learn crucial aspects that were important to complete my dissertation. I acknowledge his international outlook and his foresight.

I am also thankful to my co-supervisors, Research Scientist Kristiina Sulankivi and Senior Scientist Markku Kiviniemi, who have helpfully followed my work during my stay in VTT as well during my return to Italy. They have supported me giving precious advice to develop this project.

I would like to offer my special thanks to the Technical Research Centre of Finland (VTT), which has given me the opportunity to carry out my dissertation work in a welcoming and stimulating workplace, where I was not considered as an inconvenience but as an opportunity, and this is very important for a young person. My stay at VTT was crucial to collect information for this work. I am particularly grateful to all the VTT team, especially to Principal Scientist Hannu Koski.

I would like to thank the following companies and their representatives for the assistance with the collection of my data: Anne Urrila from Solibri Inc., Auli Karjalainen from Senate Properties, Ilkka Vainiola and Sini Kallio from Skanska and Andrea Bandera from i-Faber.

I would like to express my very great appreciation to Bill Davis, Principal Project Sponsor at UK Ministry of Justice, for checking the paragraph related to Cookham Wood case study.

I am particularly grateful for the assistance given by Alberto Alli from Harpaceas, his cordial and instructive help was essential for this work.

I also wish to acknowledge the help provided by Giovanna Romero, Karl Kristian Olsson Haave, Kjeld Svidt, Tomi Tutti, Paolo Tartarini, Mikael Laakso, Väino Tarandi, Hannes Lindblad, Robert Amor, Johannes Dimyadi and Nimalaprakasan Skandhakumar.

The assistance provided by Eng. Giovanni Caratozzolo, Luca Cattarina, Francesca Facchi, Silvia Mastrolemba, Michela Cucchi, Michela Paneroni, Giuseppina Morandi, Diana Pedroni, Evangelia Balanou and Roberta Guindani is also greatly appreciated.

Finally, I extend my gratitude to my family and friends whose support and love were there all the time during these academic years.

Contents

Abstract	3
Abstract	5
Tiivistelmä	7
Sommario	9
Acknowledgements	14
Abbreviations	17
List of figures	20
1. Introduction	27
1.1 Background.....	27
1.2 Objectives.....	27
1.2.1 Research questions.....	27
1.3 Method.....	28
1.4 Outline of the thesis.....	28
2. Public Procurement Methods	29
2.1 Introduction	29
2.2 The Tender Evaluation Process.....	29
2.3 Public Procurement Methods.....	31
2.3.1 Design-Bid-Build (DBB).....	31
2.3.2 Design-Build (DB).....	34
2.3.3 Construction Management (CM).....	37
2.3.4 Design-Build-Operate (DBO)	39
2.3.5 Design-Build-Finance-Operate (DBFO).....	40
2.4 Innovative Procurement Procedures.....	41
2.4.1 Integrated Project Delivery (IPD)	41
2.4.2 Project Alliancing (PA).....	43
2.4.3 Cost Led Procurement (CLP).....	45
2.4.4 Integrated Project Insurance (IPI)	46
2.4.5 Two Stage Open Book.....	47
2.4.6 Early BIM Partnering (EBP)	48
2.5 e-Procurement	49
3. Building Information Modelling	54
3.1 Introduction	54
3.2 The definition of BIM	54
3.2.1 The history of BIM	64
3.3 Current BIM Authorised Uses and Permitted Purposes.....	67
3.4 Interoperability.....	75
3.4.1 Introduction	75
3.4.2 Data Exchange workflows and formats	75

3.4.3	IFC and Open standards	77
3.4.4	Open BIM and Public Procurement.....	82
3.4.5	Limitations and Possibilities.....	83
3.5	BIM implementation in the Public Sector.....	83
3.5.1	Introduction	83
3.5.2	Degree of diffusion in various countries	84
3.5.3	Limitations and Possibilities.....	98
3.5.4	e-Procurement and BIM: SOA4BIM Framework.....	103
3.6	Possibilities and challenges.....	110
4.	Possible Implementation of BIM in Tendering.....	117
4.1	BIM and Procurement.....	117
4.2	Implementation of BIM in Design-Bid-Build	119
4.2.1	Introduction	119
4.2.2	Client's Obligations.....	119
4.2.3	Benefits for the Bidders	122
4.2.4	Benefits for the Client	122
4.2.5	Limitations and Potentialities	122
4.3	Implementation of BIM in Design-Build or Design Competitions	123
4.3.1	Introduction	123
4.3.2	Client's Requirements	123
4.3.3	Benefits for the Client	126
4.3.4	Benefits for the Bidders	126
4.3.5	Limitations and Possibilities	126
4.4	Model Checking in the evaluation of design proposals	127
4.4.1	Introduction	127
4.4.2	Model Checking tools	128
4.4.3	Checking from a BIM the Client's evaluation criteria and requirements.....	142
4.4.4	Examples of new kind of rules in SMC related to tendering.....	152
4.4.5	Translation of Client's requirements in SMC: the Statsbygg BIM Manual....	160
4.4.6	Limitations and Possibilities	176
4.5	Examples of BIM adoption in Tendering.....	178
4.5.1	Introduction	178
4.5.2	Architectural Competition: Aalborg University (Aalborg, Denmark)	178
4.5.3	Architectural Competition: National Museum (Oslo, Norway).....	180
4.5.4	Design Competition: Viikki Synergy Building (Helsinki, Finland)	183
4.5.5	Early BIM Partnering: Office and Shopping Space (Canada).....	185
4.5.6	Two Stage Open Book: Cookham Wood (Rochester, UK).....	189
4.5.7	Discussion.....	192
4.6	Case Study: Galli Theatre (Rimini, Italy)	192
4.6.1	Introduction	192
4.6.2	Bidders' proposals.....	193
4.6.3	e-Procurement: i-Faber simulation.....	204
4.6.4	Discussion.....	214
5.	Conclusions and Future Works.....	216
	References	218

Abbreviations

AEC	Architecture, Engineering and Construction
AECO	Architecture, Engineering, Construction and Operations
AEX	Automating Equipment Information Exchange
AIA	American Institute of Architects
BCA	Building Construction Authority
BACnet	Building Automation and Control networks
BCF	BIM Collaboration Format
BIM	Building Information Modelling
bSDD	buildingSMART Data Dictionary
CAD	Computer-Aided Design
CIS/2	CIMsteel Integration Standard, version 2
cityGML	City Geography Markup Language
CLP	Cost Led Procurement
CM	Construction Management
COBie	Construction Operations Building Information Exchange
COBIM	Common BIM Requirements 2012
CORENET	Construction and Real Estate Network
DB	Design-Build
DBB	Design-Bid-Build
DBFO	Design-Build-Finance-Operate
DBO	Design-Build-Operate
DECA	Danish Enterprise and Construction Authority
DXF	Drawing eXchange Format

EBP	Early BIM Partnering
EDMS	Electronic Document Management Systems
EMEA	Europe, Middle East and Africa
EU	European Union
FM	Facility Management
GDP	Gross Domestic Product
GIS	Geographic Information System
GSA	General Services Administrations
GSL	Government Soft Landings
GUID	Global Unique Identifier
HVAC	Heating, Ventilation and Air Conditioning
IAI	International Alliance of Interoperability
laaS	Infrastructure as a Service
ICC	International Code Council
ICT	Information and Communication Technology
ID	IDentifier
IDM	Information Delivery Manual
IFC	Industry Foundation Classes
IFD	International Framework for Dictionaries
IGES	Initial Graphic Exchange Specification
IPD	Integrated Project Delivery
IPI	Integrated Project Insurance
ISO	International Standards Organisation
IT	Information Technology
ITT	Invitation To Tender
LOD	Level of Development/Detail
MDA	Model Driven Architecture
MDS	Model Development Specification
MEA	Model Element Author
MEP	Mechanical, Electrical and Plumbing

MVD	Model View Definition
NBIMS	National BIM Standards
NIBS	National Institute of Building Science
OJEU	Official Journal of the European Union
OMG	Object Management Group
PA	Project Alliancing
PaaS	Platform as a Service
PPP	Public Private Partnership
QTO	Quantity Take-Off
SaaS	Software as a Service
SBM1.2	Statsbygg Building Information Modelling Manual Version 1.2
SBT	Smart Buildings Technologies
SMC	Solibri Model Checker
SOA	Service-Oriented Architecture
STEP	Standard for the Exchange of Product Model Data
TED	Tenders Electronic Daily
XML	eXtensible Markup Language
2D	Two Dimensional
3D	Three Dimensional

List of figures

Chapter 2

Figure 2.1. General Tendering Process (Mohemad, Hamdan, Othman and Noor, 2011, p. 283).....	30
Figure 2.2. DBB diagram (Lahdenperä, 2008, p. 13).....	31
Figure 2.3. DBB diagram (Turner, 1990, p. 49).....	32
Figure 2.4. DB diagram (Lahdenperä, 2008, p. 13).....	34
Figure 2.5. DB diagram (Turner, 1990, p. 46).....	35
Figure 2.6. CM diagram (Lahdenperä, 2008, p. 13).....	37
Figure 2.7. (a) Agency CM diagram (Lahdenperä, 2001, p. 22) and (b) At-Risk CM diagram (Lahdenperä, 2001, p. 22).....	38
Figure 2.8. DBO diagram (Lahdenperä, 2008, p. 13).....	40
Figure 2.9. DBFO diagram (Lahdenperä, 2008, p. 13).....	40
Figure 2.10. Summary of the major differences between Traditional Project Deliver and Integrated delivery (Ilozor and Kelly, 2012, p. 29).....	42
Figure 2.11. Differences in Integrated and Traditional Project Delivery (AIA, 2007a, p. 4).....	43
Figure 2.12. Interests of the contracting parties (Petäjaniemi and Lahdenperä, 2012b).....	44
Figure 2.13. Early BIM Partnering delivery method (Porwal and Hewage, 2013, p. 208).....	48
Figure 2.14. e-Procurement process (Grilo and Jardim-Goncalves, 2011, p. 109).....	53

Chapter 3

Figure 3.1. Alternative Meaning of BIM (Saxon, 2013, pp. 6–7).....	55
Figure 3.2. Some common connotations of multiple BIM terms (Succar, 2009, p. 359).....	55
Figure 3.3. AEC project team and typical organisation boundaries (Eastman, Teicholz, Sacks and Liston, 2011, p. 3).....	56
Figure 3.4. The BIM integrated process. Available at http://buildipedia.com/aec-pros/design-news/the-daily-life-of-building-information-modeling-bim?print=1&tmpl=component (last visit 15 June 2013).....	56
Figure 3.5. Three interlocking fields of BIM activity (Succar, 2009, p. 361).....	57
Figure 3.6. Stages of BIM maturity (Succar, 2009, p. 368).....	58
Figure 3.7. The BIM stages (Succar, 2009, p. 358).....	58
Figure 3.8. Project Lifecycle Phases at BIM Stage 1 (Succar, 2009, p. 366).....	59
Figure 3.9. Project Lifecycle Phases at BIM Stage 2 (Succar, 2009, p. 366).....	59

Figure 3.10. Project Lifecycle Phases at BIM Stage 3 (Succar, 2009, p. 367).	60
Figure 3.11. Stages and steps of BIM maturity (Succar, 2009, p. 368).	60
Figure 3.12. BIM Maturity Levels (Department of Business, Innovations and Skills, 2011, p. 16).	61
Figure 3.13. Example of steel structure at increasing LODs (Bedrick, 2013b, p. 2). ...	62
Figure 3.14. Example of MDS (Bedrick, 2013b, p. 2).....	62
Figure 3.15. Example of Levels of Development. Available at http://practicalbim.blogspot.com.au/2013/03/what-is-this-thing-called-lod.html?goback=gmr_68075.gde_68075_member_218542623 (last visit 1 July 2013).	63
Figure 3.16. Example of Levels of Detail. Available at http://practicalbim.blogspot.com.au/2013/03/what-is-this-thing-called-lod.html?goback=gmr_68075.gde_68075_member_218542623 (last visit 1 July 2013).....	64
Figure 3.17. Architectural, Structural and MEP models (Azhar, Hein and Sketo, 2008).	67
Figure 3.18. Merging of BIM models (COBIM, 2012, Series 6, p. 7).	68
Figure 3.19. 2D drawings extracted from the model (COBIM, 2012, Series 5, p. 14).	68
Figure 3.20. (a) Structural details (COBIM, 2012, Series 8, p. 13) and (b) Photo-realistic illustration (COBIM, 2012, Series 8, p. 6).	69
Figure 3.21. Evaluation of design alternatives (Eastman, Teicholz, Sacks and Liston, 2011, p. 158).	69
Figure 3.22. Clash detection between MEP and structural models (COBIM, 2012, Series 6, p. 11).	70
Figure 3.23. Example of Quantity Takeoff tool.....	71
Figure 3.24. 4D simulation. Available at http://www.mrasbuilt.com/MAB_BIM_Navis.html (last visit 9 June 2013).	71
Figure 3.25. Cost estimation using a BIM software programme. Available at http://www.tocoman.fi/sites/default/files/webfm/user/Tocoman_Easy%20BIM_finalKT_screen.pdf (last visit 9 June 2013).	72
Figure 3.26. MEP analysis (COBIM, 2012, Series 9, p. 7).	72
Figure 3.27. Lighting analysis (COBIM, 2012, Series 9, p. 14).	73
Figure 3.28. Examples of 3D site layouts (Sulankivi, Mäkelä and Kiviniemi, 2009, p. 40). ...	73
Figure 3.29. Examples of a BIM-based safety railing plan (Sulankivi and Kiviniemi, 2011, p. 14).	74
Figure 3.30. Visualisation of system zones (COBIM, 2012, Series 12, p. 10).	74
Figure 3.31. Interoperability between different platforms. Available at http://www.harpaceas.it/sito/simple.nsf/PagOK/Pilloledi-BIM (last visit 3 June 2013). In Italian.....	76
Figure 3.32. Schema and schema language (Eastman, Teicholz, Sacks and Liston, 2011, p. 106).	77
Figure 3.33. Two conceptual scenarios of interoperability: direct translators vs. an open interoperability standard (Bloor and Owen, 1995, p. 18; Laakso and Kiviniemi, 2012, p. 137).	78
Figure 3.34. IFC data file formats and icons. Available at http://www.buildingsmart-tech.org/specifications/ifc-overview/ifc-overview-summary (last visit 4 June 2013).	78
Figure 3.35. History of IFC development (BuildingSMART, 2013a).	79
Figure 3.36. Illustration of model views as a subset of the exchange schema (Venugopal, Eastman, Sacks and Teizer, 2012, p. 413).	80

Figure 3.37. Layers of the information exchange framework (Laakso and Kiviniemi, 2012, p. 150).....	80
Figure 3.38. buildingSMART standards. Available at http://www.buildingsmart-tech.org/specifications (last visit 5 June 2013).....	81
Figure 3.39. (a) BIM e-Submission Guideline for Architectural Discipline. Available at http://www.corenet.gov.sg/integrated_submission/bim/BIM/BIM_Submission_Guideline (v3-5)_Jan10 (Official%20Release).pdf (last visit 17 June 2013) and (b) Singapore BIM Guide Version 2 (BCA, 2013).....	84
Figure 3.40. GSA BIM Guide, Series 1 Overview. Available at http://www.gsa.gov/graphics/pbs/GSA_BIM_Guide_v0_60_Series01_Overview_05_14_07.pdf (last visit 23 June 2013).	85
Figure 3.41. (a) Building Information Modeling (BIM) Roadmap (US Army Corps of Engineers, 2011) and (b) National Building Information Modelling Standards (National Institute of Building Science, 2007).....	86
Figure 3.42. COBIM, Series 1 General Part (COBIM, 2012).....	87
Figure 3.43. (a) Government Construction Strategy (Cabinet Office, 2011) and (b) AEC (UK) BIM Protocol. Available at http://aecuk.files.wordpress.com/2012/09/aecukbimprotocol-v2-0.pdf (last visit 17 June 2013).....	88
Figure 3.44. Statsbygg Building Information Modelling Manual Version 1.2 (Statsbygg, 2011)..	89
Figure 3.45. 3D Working Method 2006 (BIPS, 2007).....	90
Figure 3.46. Rgd BIM Standard (Rijksgebouwendienst, 2012).	91
Figure 3.47. (a) Architectural BIM Guide v 1.0 Available at http://www.buildingsmart.or.kr/Document/BIM_Guide_vol1_KoreaPPS_2010_eng.pdf (last visit 17 June 2013) and (b) National Architectural BIM Guide. Available at http://www.buildingsmart.or.kr/Document/BIM_Guide_MLTL_Korea_2010_eng.pdf (last visit 17 June 2013).....	92
Figure 3.48. (a) BIM Standards Manual for Development and Construction Division of Hong Kong Housing Authority. Available at: http://www.housingauthority.gov.hk/en/business-partnerships/resources/building-information-modelling/index.html (last visit 17 June 2013) and (b) BIM Library Components Design Guide for Development and Construction Division of Hong Kong Housing Authority. Available at http://www.housingauthority.gov.hk/en/business-partnerships/resources/%20building-information-modelling/index.html (last visit 17 June 2013).	93
Figure 3.49. (a) National Guidelines for Digital Modelling. 2009. Available at http://www.construction-innovation.info/images/pdfs/BIM_Guidelines_Book_191109_lores.pdf (last visit 17 June 2013) and (b) National Building Information Modelling Initiative Volume 1:Stategy (BuildingSMART Australasia, 2012).	94
Figure 3.50. (a) Building Industry Performance Measures – Part One (Page and Curtis, 2012) and (b) New Zealand National BIM Survey 2012 (Masterspec, 2012).....	95
Figure 3.51. Riigi Kinnisvara AS Mudelprojekteerimise juhend 2013. Available at http://www.rkas.ee/parim-praktika/bim (last visit 17 June 2013).....	96
Figure 3.52. BIM – Standardiseringsbehov. Available at http://www.openbim.se/~media/%20Files_OpenBIM/Projekt/130620_BIM_rapport.ashx (last visit 17 July 2013).	97
Figure 3.53. BIM policy stage by adopting rating in EMEA (Kiviniemi, 2013).....	99
Figure 3.54. Generic SOA4BIM Framework (Grilo and Jardim-Goncalves, 2011, p. 112)....	105
Figure 3.55. Cloud Platform of the BIM-IF/STEP for Clash Detection processes (Jardim-Goncalves and Grilo, 2010, p. 396).....	107
Figure 3.56. Advantages of BIM technology in answer to the increasing pressure on the Building Process (Eastman, Teicholz, Sacks and Liston, 2011, p. 20).....	110

Figure 3.57. Comparison between traditional DBB paper-based process and collaborative BIM-based delivery process (Eastman, Teicholz, Sacks and Liston, 2011, p. 153).....	115
Figure 3.58. (a) Advantages of BIM (Yan and Damian, 2008) and (b) Drawbacks of BIM (Yan and Damian, 2008).....	116

Chapter 4

Figure 4.1. Diagram of the main aspects of the client's obligations in DBB.	121
Figure 4.2. Ruleset Manager tool in Solibri Model Checker v8.	129
Figure 4.3. Model layout in Solibri Model Checker v8.....	130
Figure 4.4. Checking layout in Solibri Model Checker v8.....	130
Figure 4.5. Result Summary in Solibri Model Checker v8.1.....	131
Figure 4.6. (a) Example of EDM Model Server desktop window (Bell, Bjørkhaug and Hjelseth, 2009, p. 15) and (b) Example of EDM Model Server report (Ding, Drogemuller, Jupp, Rosenman and Gero, 2004, p. 11).	131
Figure 4.7. Room overview with model connection. Available at http://www.drofus.no/en/product/modules/room-overview.html (last visit 2 May 2013).....	132
Figure 4.8. Example of Affinity desktop window. Available at http://www.trelligence.com/images/HowWorks_3D.gif (last visit 25 June 2013).....	133
Figure 4.9. Example of dProfiler desktop window. Available at http://beck-technology.com/assets/dp06_mixed-use.png (last visit 25 June 2013).	134
Figure 4.10. Clash detection between two sets of elements in Autodesk Navisworks. Available at http://www.autodesk.com/products/autodesk-navisworks-family/features (last visit 2 May 2013).....	135
Figure 4.11. Example of Tekla BIMsight desktop window.....	136
Figure 4.12. Example of detect and resolve clashes tool in Bentley Projectwise Navigator. Available at http://www.bentley.com/NR/rdonlyres/A12EE3B3-4347-4E19-A6B4-7F049A0D08D8/0/nav03.jpg (last visit 11 May 2013).	137
Figure 4.13. Example of Riuska desktop window. Available at http://apps1.eere.energy.gov/buildings/tools_directory/screenshots.cfm/ID=239/pagename_submenu=/pagename_menu=/pagename=alpha_list_sub (last visit 11 May 2013).	138
Figure 4.14. Example of Autodesk Ecotect desktop window. Available at http://apps1.eere.energy.gov/buildings/tools_directory/screenshots.cfm/ID=391/pagename_submenu=/pagename_menu=/pagename=alpha_list_sub (last visit 11 May 2013).	139
Figure 4.15. (a) Example of division of the project into locations using EasyBIM and (b) Example of creation of a new element for the QTO tool in EasyBIM.	140
Figure 4.16. Example of Vico Cost Planner desktop window. Available at http://www.vico-software.com/products/vico-office-cost-planner/tabid/85288/Default.aspx (last visit 11 May 2013).....	141
Figure 4.17. Example of CostX desktop window. Available at http://www.mitbrand.com/assets/documents/PDF/5D_Cost_Planning_MitchellBrandtman_19-04-2013.pdf (last visit 24 August 2013).....	142
Figure 4.18. (a) Intersection of walls in Solibri Model Checker v8 and (b) Intersection between a door and a slab in Solibri Model Checker v8.....	143
Figure 4.19. Model Tree View in Solibri Model Checker v8.	144
Figure 4.20. Visual check of the location of the model origin in Solibri Model Checker v8.1..	145
Figure 4.21. Info window of the Model layout in Solibri Model Checker v8.	145

Figure 4.22. Example of BIM file naming convention rule in Solibri ModelChecker v8.1.	146
Figure 4.23. Example of Space Distance Check rule in Solibri Model Checker v8.1.	146
Figure 4.24. Example of Space Area Check rule in Solibri Model Checker v8.1.....	147
Figure 4.25. Example of rule to check the presence of components in spaces in Solibri Model Checker v8.1.	148
Figure 4.26. Example of rule for checking properties of elements in Solibri Model Checker v8.	149
Figure 4.27. Solar radiation and shading studies with Autodesk Ecotect. Available at http://sustainabilityworkshop.autodesk.com/software/ecotect (last visit 2 May 2013).	149
Figure 4.28. Information Takeoff tool in Solibri Model Checker v8.1.....	150
Figure 4.29. Example of check result of free space for a wheelchair in a bathroom with SMC (Bellomo, 2012).....	151
Figure 4.30. Example of rule for checking escape routes in Solibri Model Checker v8.1.....	152
Figure 4.31. Space Distance Check rule in Solibri Model Checker v8.1.	153
Figure 4.32. Requirements of the Space Distance Check rule in Solibri Model Checker v8.1.....	153
Figure 4.33. Customisation of the Space Distance Check rule in Solibri Model Checker v8.1.....	154
Figure 4.34. Classification of Transmission Loss Walls in Solibri Model Checker v8.1.....	155
Figure 4.35. Property Rule Template with Component Filters rule (SOL/230) in Solibri Model Checker v8.1.	155
Figure 4.36. Check Transmission Loss rule in Solibri Model Checker v8.1.....	156
Figure 4.37. Comparison Between Property Values rule (SOL/231) in Solibri Model Checker v8.1.	157
Figure 4.38. Check Transmission Loss 2 rule in Solibri Model Checker v8.1.....	158
Figure 4.39. Checking Result of the Check Transmission Loss rule in Solibri Model Checker v8.1.	159
Figure 4.40. Checking Result of the Check Transmission Loss 2 rule in Solibri Model Checker v8.1.	159
Figure 4.41. Rulesets of Statsbygg BIM Manual in Solibri Model Checker.	161
Figure 4.42. Rulesets of Statsbygg BIM Manual in Solibri Model Checker, B.1 Basic BIM requirements.....	162
Figure 4.43. Rulesets of Statsbygg BIM Manual in Solibri Model Checker, B.2 BIM – Generic model structure requirements.....	164
Figure 4.44. Rulesets of Statsbygg BIM Manual in Solibri Model Checker, B.3 The Requirement BIM from the client.	165
Figure 4.45. Rulesets of Statsbygg BIM Manual in Solibri Model Checker, C.1 Architecture Modelling.	167
Figure 4.46. Rulesets of Statsbygg BIM Manual in Solibri Model Checker, C.5 Structural Engineering Modelling, Outline Conceptual Design – Default modelling requirements.	170
Figure 4.47. Rulesets of Statsbygg BIM Manual in Solibri Model Checker, C.5 Structural Engineering Modelling, Full Conceptual Design – Default modelling requirements.....	171
Figure 4.48. Rulesets of Statsbygg BIM Manual in Solibri Model Checker, C.5 Structural Engineering Modelling, Coordinated design, procurement and full financial authority – Default modelling requirements.....	171

Figure 4.49. Rulesets of Statsbygg BIM Manual in Solibri Model Checker, C.6 Mechanical Engineering Modelling, Outline Conceptual Design – Default modelling requirements.....	172
Figure 4.50. Rulesets of Statsbygg BIM Manual in Solibri Model Checker, C.6 Mechanical Engineering Modelling, Full Conceptual Design – Default modelling requirements.....	172
Figure 4.51. Rulesets of Statsbygg BIM Manual in Solibri Model Checker, C.6 Mechanical Engineering Modelling, Coordinated design, procurement and full financial authority – Default modelling requirements.....	173
Figure 4.52. Rulesets of Statsbygg BIM Manual in Solibri Model Checker, C.7 Electrical and Communications Engineering Modelling, Outline Conceptual Design – Default modelling requirements.....	174
Figure 4.53. Rulesets of Statsbygg BIM Manual in Solibri Model Checker, C.7 Electrical and Communications Engineering Modelling, Full Conceptual Design – Default modelling requirements.....	174
Figure 4.54. Rulesets of Statsbygg BIM Manual in Solibri Model Checker, C.7 Electrical and Communications Engineering Modelling, Coordinated design, procurement and full financial authority – Default modelling requirements.	175
Figure 4.55. Rulesets of Statsbygg BIM Manual in Solibri Model Checker, C.8 Acoustical Engineering Modelling.....	175
Figure 4.56. Rulesets of Statsbygg BIM Manual in Solibri Model Checker, C.9 Fire Safety Engineering Modelling.....	176
Figure 4.57. (a) 3D model of the cluster of university buildings (Svidt and Karlshøj, 2005) and (b) A proposal for modernising the cluster of university buildings (Svidt and Karlshøj, 2005).....	179
Figure 4.58. (a) Urban Transition’s BIM model for Phase 1 and (b) BIM model of the competition area (Kvarsvik, 2010a). Available at http://statsbygg.no/Utviklingsprosjekter/Nasjonalmuseet/ Konkurransen/Fase-1/ (last visit 7 February 2013).....	180
Figure 4.59. Space Programme of the Architectural Competition of the National Museum at Vestbanen.	181
Figure 4.60. (a) Exterior perspective view (Senaatti and SYKE, 2010d), (b) Façade to the West (Senaatti and SYKE, 2010d) and (c) Plan of the competition winner ‘Apila’ (Senaatti and SYKE, 2010d).	184
Figure 4.61. Monthly average solar irradiance on the different surfaces using IFC data. (Porwal and Hewage, 2013, p. 212).	187
Figure 4.62. Comparison between traditional DBB and BIM Partnering methods (Porwal and Hewage, 2013, p. 212).	188
Figure 4.63. (a) 3D model of the surrounding area of Cookham Wood Youth Justice Board (BIM Task Group, 2013a) and (b) 3D model of the Cookham Wood Youth Justice Board New Build Young Offenders Institution (BIM Task Group, 2013b, p. 3).....	189
Figure 4.64. View of the current status of the theatre Galli in Rimini.....	194
Figure 4.65. Rendering of the client’s site layout.	194
Figure 4.66. 2D client’s site layout plan.	195
Figure 4.67. (a) Client’s first phase of the site layout plan and (b) Client’s second phase of the site layout plan.	195
Figure 4.68. Bidder A’s first phase of the site layout plan	196
Figure 4.69. Bidder A’s second phase of the site layout plan.	196

Figure 4.70. Bidder B’s site layout plan.	197
Figure 4.71. Bidder A’s proposal imported in Solibri Model Checker v8.1.....	198
Figure 4.72. Checking results of bidder A’s proposal in Solibri Model Checker v8.1.	198
Figure 4.73. Ruleset in SMC v8.1 to check the dimension of spaces.....	199
Figure 4.74. (a) Ruleset in SMC v8.1 to check distance from a site office to a pedestrian gate is not too long and (b) Ruleset in SMC v8.1 to check distance from a site office to a WC is not too long.....	199
Figure 4.75. Ruleset in SMC v8.1 to check the dimension of scaffoldings.	200
Figure 4.76. Bidder B’s proposal imported in Solibri Model Checker v8.1.....	201
Figure 4.77. Checking results of bidder B’s proposal in Solibri Model Checker v8.1.....	201
Figure 4.78. Ruleset in SMC v8.1 to check if there is enough clearance on both sides of a gate.....	202
Figure 4.79. (a) Ruleset in SMC v8.1 to check distance from a site office to a pedestrian gate is not too long and (b) Ruleset in SMC v8.1 to check if the height of fences is correct.	202
Figure 4.80. (a) Client’s layout of duct systems under the stage and (b) Bidder’s layout of ductsystems under the stage.....	203
Figure 4.81. (a) Client’s disposition of canal systems in an upper level and (b) Bidder’s disposition of canal systems in an upper level.....	203
Figure 4.82. Client’s layout of canal systems.....	204
Figure 4.83. Bidder’s layout of canal systems.	204
Figure 4.84. i-Faber platform: import of information from the SIMOG system.....	205
Figure 4.85. i-Faber platform: initial tender information.....	208
Figure 4.86. i-Faber platform: tender information.....	209
Figure 4.87. i-Faber platform: award criteria.....	210
Figure 4.88. i-Faber platform: dimension of the attached documents.	211
Figure 4.89. i-Faber platform: attached documentation.	211
Figure 4.90. i-Faber platform: deadline of the tender period.....	212
Figure 4.91. i-Faber platform: example of a technical sheet.	212
Figure 4.92. i-Faber platform: example of a technical sheet with different weights for different parameters.....	213
Figure 4.93. i-Faber platform: step by step procedure to submit a bid.....	213
Figure 4.94. i-Faber platform: set up of a bid.....	214

1. Introduction

1.1 Background

In the Construction Industry, especially in the Public Sector, the tendering, where the preferred contractor is selected and the price agreed, is a very important step for the success of a project. However, practice shows that usually there are problems and the price rises up along the construction process not only due to errors in the project itself or changes applied by the client, but also due to additional works and materials to be adopted which were not included or well described into the tender documentation. A new modus operandi called Building Information Modelling (BIM) is emerging in the Construction Sector to reduce usual mistakes of 2D paper-based management of the procedures, thanks to a digital approach that is easier controlled and analysed. BIM can improve the overall process, but its spread is more advanced in the phases after the tender award. The BIM adoption in the earlier stages has not yet been widely spread.

1.2 Objectives

The aim of this thesis is to identify the main problems related to the bidding phase of different public procurements and to study how BIM could be utilised in Tendering to improve the current weak points. The role of Model Checking is investigated to understand how it can be applied within the selection of a contractor in ordinarily Public Procurement Methods, as well as in some new methods recently adopted in accordance with BIM processes.

1.2.1 Research questions

In order to achieve the objectives, I have worked with the following research question:

- How BIM can be implemented in Tendering to improve the selection of the best contractor in public works?

Later, this main research question has been further developed and divided in sub-questions:

- What are the requirements concerning a call for tender in case of BIM-based procurement? What information must be provided?
- Which are the relations between e-Procurement and BIM? Can e-Procurement support a BIM-based tender?
- Which are the requirements for assessing bids in different procurement types? And which issues are checked from BIMs using Model Checking tools?

- Which are the main Model Checking tools available by now?
- How does the management in BIM-based public procurements change when moving from traditional methods to BIM-based ones to fully obtain advantages?
- Are there Case studies about this issue? What is the level of maturity in adopting BIM in procurement and bidding in other countries?

1.3 Method

Before digging into practical issues, an overview of theoretical topics related to the thesis has been carried out. It describes main public procurement methods and the BIM concept. The literature review is useful to identify the available primary studies relevant to the topic of the thesis. Moreover, it supports not only a prior knowledge in the subject, but also the analysis of empirical data, which have been collected evaluating case studies, interviewing experts and conducting practical tests through BIM software and e-Procurement platform.

1.4 Outline of the thesis

This M.Sc. Thesis comprises five chapters:

Chapter 1 briefly introduces the project background, objectives, methods and outline.

Chapter 2 deals with the theoretical part where the main Public Procurement Methods, both the most popular and the emerging ones, are presented.

Chapter 3 still deals with the theoretical part and it shows the Building Information Modelling (BIM) approach and applications, the interoperability issue, the BIM implementation in the Public Sector around the world and the possibilities and challenges related to its adoption.

Chapter 4 studies a possible implementation of BIM in Tendering, especially in the DBB and DB procurements and in Design competitions. Model Checking tools are studied to understand their role in the evaluation of bidders' proposals, giving more importance to the software Solibri Model Checker. Moreover, case studies available in literature are analysed together with an Italian case study where BIM is implemented to demonstrate its potential.

Chapter 5 presents the conclusion of the work and future developments.

2. Public Procurement Methods

2.1 Introduction

This chapter shortly describes the ordinary Tender Evaluation process, the main Public Procurement Methods in the Construction Industry and the e-Procurement system. This overview is useful to understand better the possible BIM adoption within the Public Procurement presented in Chapter 4.

A distinction between 'traditional' and 'innovative' Procurement Methods has been made. The most common Procurement Methods are:

- Design-Bid-Build (DBB)
- Design-Build (DB)
- Construction Management (CM)
- Design-Build-Operate (DBO)
- Design-Build-Finance-Operate (DBFO)

Nowadays other approaches are spreading and the major ones are:

- Integrated Project Delivery (IPD)
- Project Alliancing (PA)
- Cost Led Procurement (CLP)
- Integrated Project Insurance (IPI)
- Two Stage Open Book
- Early BIM Partnering (EBP).

2.2 The Tender Evaluation Process

By referring to Mohemad, Hamdan, Othman, and Noor (2011), the selection of the most qualified contractor is still one of the most critical issues to fulfil a successful project. A short description of the main steps of the actual Tendering process is provided to better understand the possible application of BIM proposed in Chapter 4.

In Europe the award of public contracts by or on behalf of Member States authorities has to comply with specific principles such as 'equal treatment, the principle of non-discrimination, the principle of mutual recognition, the principle of proportionality and the principle of transparency' (European Parliament, 2004). Usually the process can be outlined as:

- Tender specification preparation
- Invitation to the tender
- Submission of the tender documents by the bidders
- Evaluation of the proposals
- Tender awarding.

The preparation of the tender specifications usually involves a preliminary discussion between the client/owner and consultants to set an agreed tender documentation. Later, tenderers are invited to present offers depending on the chosen type of tender (such as open, restricted or negotiated). Interested contractors/providers can apply for the tender by submitting their bids and qualification on tender documents. Usually the client does not open the bids until the end of the offering time. Consequently, a group of experts appointed by the owner and the consultant assesses the bids according to predefined evaluation criteria and, at the end, declared preferred bidder is awarded. Figure 2.1 shows the main steps of the process.

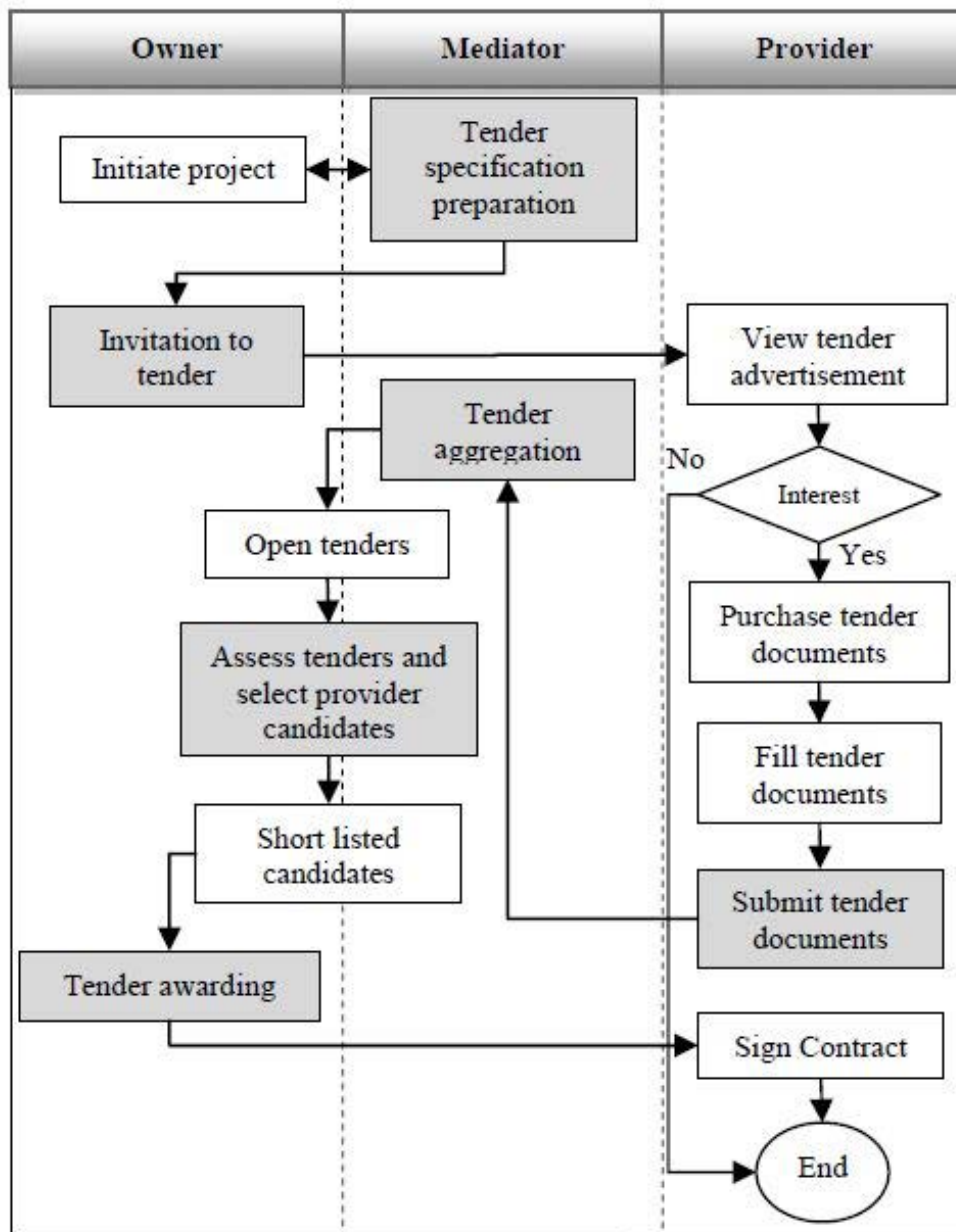

Figure 2.1. General Tendering Process (Mohemad, Hamdan, Othman and Noor, 2011, p. 283).

2.3 Public Procurement Methods

This paragraph shortly presents the most widespread Public Procurement Methods, which are the following:

- Design-Bid-Build (DBB)
- Design-Build (DB)
- Construction Management (CM)
- Design-Build-Operate (DBO)
- Design-Build-Finance-Operate (DBFO).

2.3.1 Design-Bid-Build (DBB)

Design-Bid-Build (DBB) is a very popular project delivery system (Eastman, Teicholz, Sacks and Liston, 2011, p. 4) and for this reason it is also called 'Traditional' method (Turner, 1990, p. 48; Lahdenperä, 2001). In DBB the designs are provided directly to the client and the contractor is involved only in the construction phase (Koppinen and Lahdenperä, 2004, p. 27) (Figure 2.2). Therefore, different parties are responsible for design and construction, and drawings have already progressed far when the contractor is selected. Bidders calculate quantities to estimate costs and usually the winning contractor is the one who presents the lowest responsible bid (Eastman, Teicholz, Sacks and Liston, 2011, p. 5). Moreover, periodic maintenance is commissioned separately or performed by the client (Lahdenperä, 2008, p. 12).

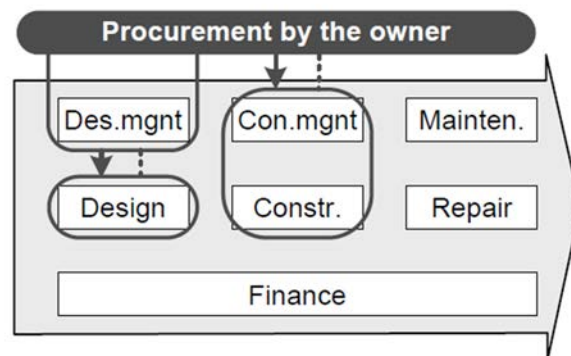

Figure 2.2. DBB diagram (Lahdenperä, 2008, p. 13).

The main steps are (Turner, 1990, pp. 48, 50) (Figure 2.3):

- defining the need to build and the purpose of the work;
- defining the client's requirements of the technical proposals;
- giving task to a design team which develops drawings and cost control;
- the client's acceptance of the design team work;
- preparing tender documentation;
- selecting and inviting tenders to tender;
- the contractor or contractors preparing their proposals;
- selection and acceptance of a tender which then becomes a contract;
- construction of the building;
- testing of the building.

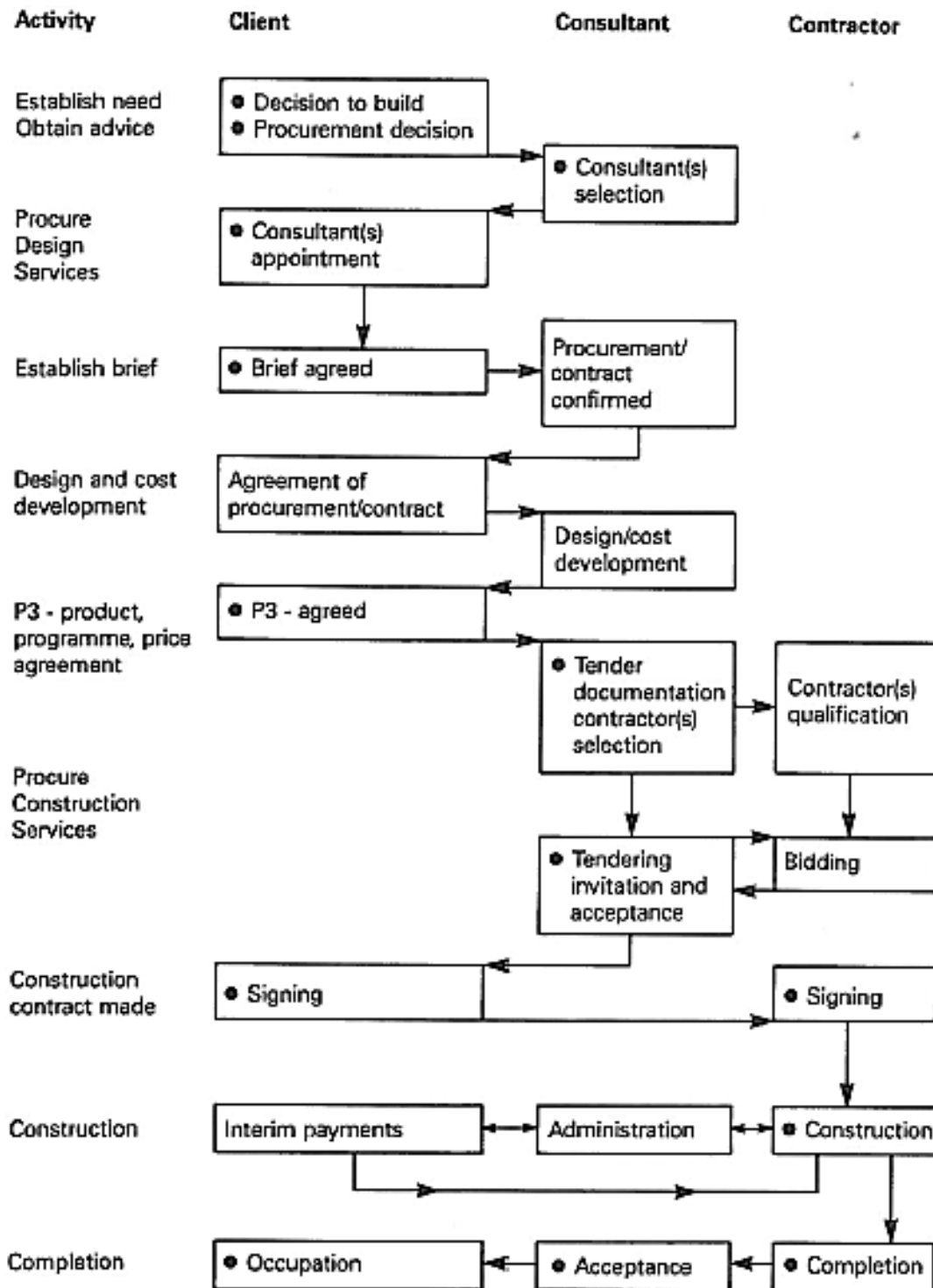

Figure 2.3. DBB diagram (Turner, 1990, p. 49).

The main variations to this method are:

Single contract: the project is awarded as one entity to one contractor, who has the responsibility for delivering the project either in-house or with the help of sub-contractors (Koppinen and Lahdenperä, 2004, p. 28);

Separate contracts ('multiple prime'): the client divides the project up and awards contracts to a few different contractors (Koppinen and Lahdenperä, 2004, p. 28).

The main advantages and disadvantages related to this methods are the following.

- Advantages (Turner, 1990, pp. 50–52):
- the client is able to communicate their needs to the designer;
- the client can verify the compliance of design solution with needs, so they have full control over design details;
- the designer acts merely as a consultant with no risks on structural solutions as long as their conduct is professional;
- this method is very well known;
- clients should know their financial commitment before entering into a construction contract because design has been fully developed at the tender stage;
- design can be carried out without under pressures of programme or price because no contractor has yet been engaged;
- the evaluation of the different offers is relatively easy because drawings and bills of quantities provide a common basis for tendering;
- the bids are more competitive and the owner is able to achieve the lowest price.

Disadvantages (Turner, 1990, pp. 50–52; Eastman, Teicholz, Sacks and Liston, 2011, pp. 5–6):

- design and construction are separated;
- the overall period of design and construction is generally longer than the one required for other procurement methods and it may be make the total project price higher;
- the tender documentation must contain sufficient detail to make easy construction bids, however, the design teams usually include fewer details in the drawings or they specify that it is not possible to rely on the dimensional accuracy of their drawings to avoid possible liability. For this reason there are many disputes with the contractor and most of the fabrication and construction takes place onsite;
- before the construction phase the winner prepares accurate drawings called shop drawings. If they are based on wrong or inaccurate drawings, it is possible to have extra-cost during the construction phase;
- during the construction phase many changes are made for different reasons (e.g. presence of errors or omissions) and for each of them there is a specific procedure to follow, which often involves legal disputes, added costs and delays;
- contractor usually offers too low bids to win the tender and after that they try to regain money abusing of the change process. Therefore, there are several disputes between the client and the contractor;
- big efforts to adopt in a correct way all information for the facility management provided to the owner after the construction phase.

The Client needs in-house skills in order to (Turner, 1990, pp. 92–93):

- prepare client's requirements;
- prepare drawings;
- select the right contractor making the process as objective as possible.

2.3.2 Design-Build (DB)

Design-Build (DB) is a project delivery system where a contractor is responsible for the client for both design and construction under a single Design-Build contract on standards provided by the client (Koppinen and Lahdenperä, 2004, p. 32) (Figure 2.4). A single entity may perform all of the design and construction or it may subcontract to other companies and periodic maintenance is commissioned separately or performed by the client (Koppinen and Lahdenperä, 2004, p. 32; Lahdenperä, 2008, p. 12).

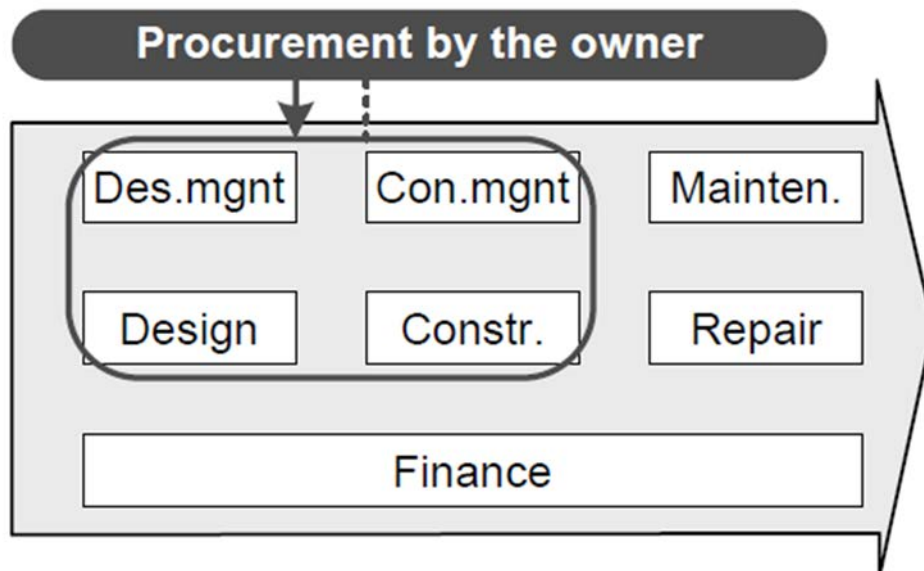

Figure 2.4. DB diagram (Lahdenperä, 2008, p. 13).

The main steps are (Turner, 1990, pp. 45–46) (Figure 2.5):

- defining the need to build and the scope of the work;
- defining the client's requirements of the technical proposals;
- selecting and inviting bidders to tender;
- the contractor or contractors preparing their technical, scheduled and price proposals;
- selection and acceptance of a tender which then becomes a contract. A selection criterion, in addition to price, may be also the quality of the design solution (qualifications-based and/or cost-based);
- design and construction of the building.

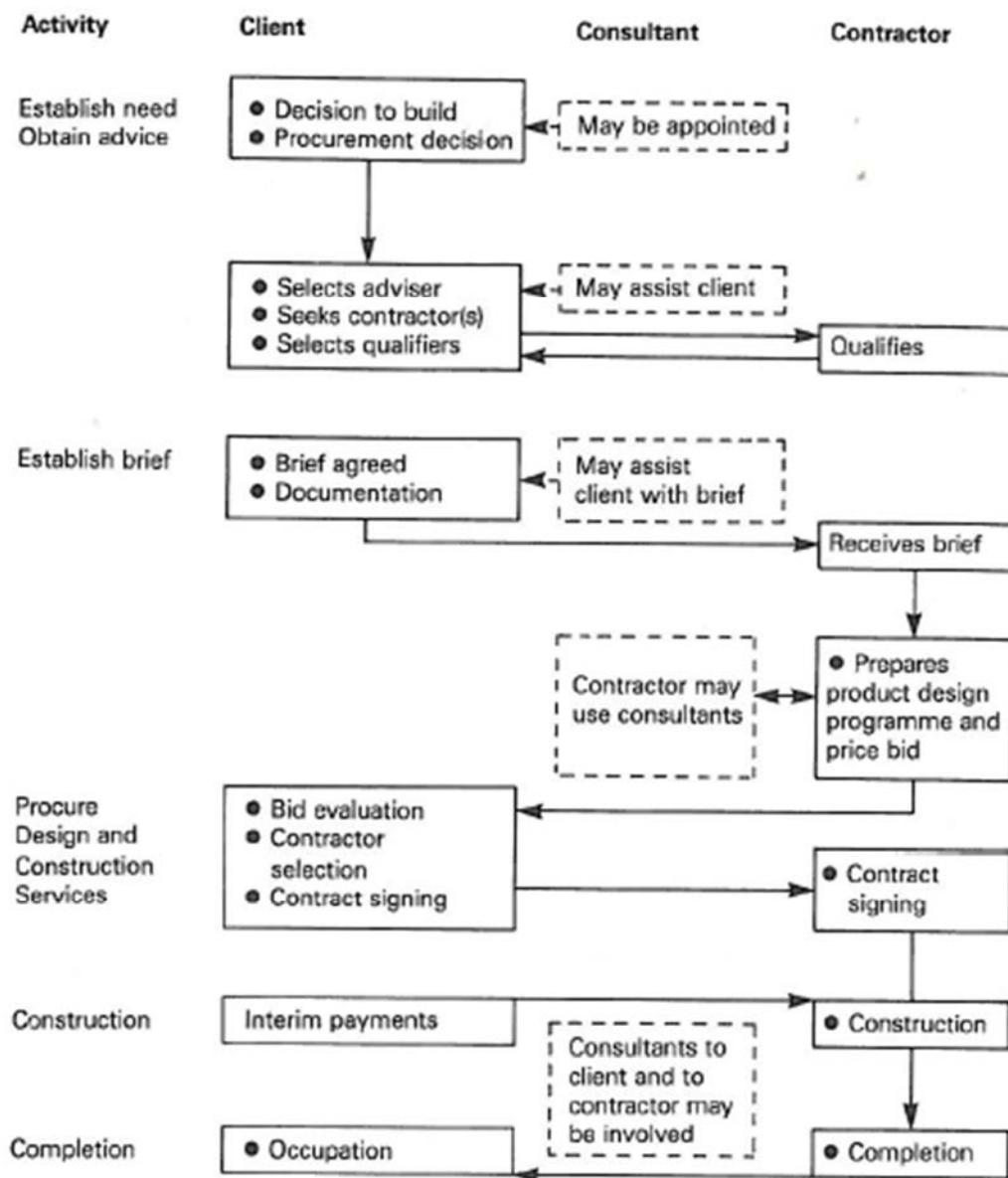

Figure 2.5. DB diagram (Turner, 1990, p. 46).

The main variations to this method are:

Direct: there is no a competition between several bidders but only one tenderer (Turner, 1990, p. 46);

Competitive: several contractors take part in the tender (Turner, 1990, p. 47);

Develop and Construct: there is a partial stage ('scope design') where the client contracts with a designer to develop parts of design which clearly fixes and documents the basic design needs, then there is a competitive tender to develop and complete the design and construct the building. The contractor becomes responsible also for the initial design (Turner, 1990, p. 47; Koppinen and Lahdenperä, 2004, p. 33);

Package deal: all-inclusive variation, it is usually used when buildings are provided rather than innovative designs (Turner, 1990, p. 47);

Turnkey: it is similar to package deal in which a single contractor brings the project to a state of 'ready for use' and the client pays at the end of the work (Turner, 1990, p. 47; Koppinen and Lahdenperä, 2004, p. 33; Dorsey, 1997, pp. 95–96);

Bridging: there is an initial phase during which the client draws up a large portion of preliminary project design, however contractor assumes liability for both design and construction and the contract is awarded based on the lowest price (Koppinen and Lahdenperä, 2004, p. 33; Dorsey, 1997, pp. 97–98);

Novation: it is similar to 'Develop and Construct' method however, after the award the contractor receives the contractual relationship between the client and the designer and they must produce any missing information for construction (Koppinen and Lahdenperä, 2004, p. 33; Dorsey, 1997, pp. 97–98);

Early Contractor Involvement: there is a pre-design phase in which the contractor takes part to give input during the setting of the tender documentation. The selection of competitor might be based on qualifications (Koppinen and Lahdenperä, 2004, p. 33; Dorsey, 1997, pp. 97–98).

The main advantages and disadvantages related to this methods are:

Advantages (Turner, 1990, pp. 47–48; Dorsey, 1997, pp. 89–91; Eastman, Teicholz, Sacks and Liston, 2011, pp. 7–8):

- the client gets single point of responsibility from one contractor;
- the client has less risk;
- the client should know the financial commitment early in the process;
- the single point of responsibility for both design and construction assigned to the contractor produces economies for both contractor and client;
- the contractor's experience can give positive contributions in programme and price to both client and contractor (quick completion of a project and low acquisition price);
- contractors that are knowledgeable about the briefing and design process of defined types of buildings may be able to offer programme advantages;
- changes are usually made earlier in the process so the amount of money and time needed to incorporate them is reduced;
- this type of contract have a tendency to reduce changes during construction which are negative to both client and contractor, so usually there are fewer legal complications;
- during the competition there may be advantageous offers to the client related to both design and/or price (low acquisition price).

Disadvantages (Turner, 1990, pp. 47–48; Dorsey, 1997, pp. 89–91; Koppinen and Lahdenperä, 2004, p. 32):

- it might be difficult to compare alternative design offers;
- unsuccessful tenders may generate significant design costs that usually become a cost that needs to be recovered from successful projects;
- the client loses control over the design phase compared to the traditional systems;

- the presence of less detailed documents early in the process may generate misunderstandings between the client and the contractor;
- there is a considerable loss of time and resources for the screened out tenders so many constructor are disenchanted to take part into public DB competitions. Therefore, public client tries to simplify the selection process while avoiding favouritism.

Client needs in-house skills in order to define (Turner, 1990, p. 45; Dorsey, 1997, pp. 92–93):

- client's requirements;
- the scope of the project;
- activities to be housed in the new building;
- space needs;
- life cycle considerations and possible future expansion;
- site information;
- ergonomic considerations;
- functional requirement;
- the budget and its level of certitude;
- personnel to be accommodated;
- aesthetic statement;
- project schedule;
- expected level of quality, described in accurate terms;
- select the right contractor making the process as objective as possible.

2.3.3 Construction Management (CM)

Construction Management (CM) is a project delivery system where, in addition to a designer, the client hires a manager to manage the overall project and the implementation is assigned to several partial construction contracts held by the client (CM-at-fee) or by the management contractor (CM-at-risk) (Lahdenperä, 2008, p. 12) (Figure 2.6). In this way different parties are responsible for design and construction, but the CM organisation takes part in management of both (Lahdenperä, 2008, p. 13). Indeed, a construction manager works throughout the several phases and collaborates with the client and the designers in furthering the client's interests (Koppinen and Lahdenperä, 2004, p. 29). Periodic maintenance is commissioned separately (Lahdenperä, 2008, p. 12).

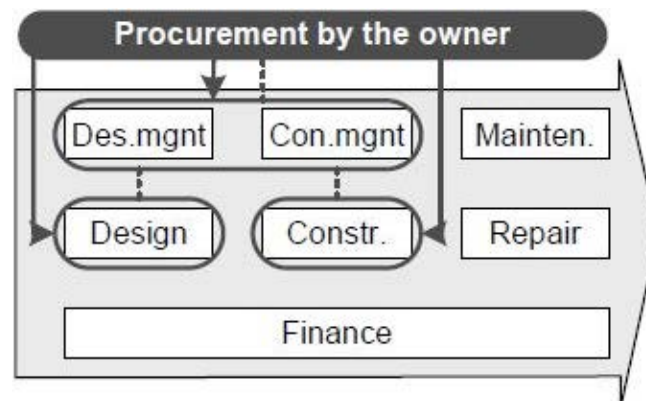

Figure 2.6. CM diagram (Lahdenperä, 2008, p. 13).

The main steps are (Turner, 1990, p. 53):

- defining the need to build;
- defining the client's requirements;
- selecting a design team;
- selecting a management organisation;
- evolution of the programme and design requirements;
- tendering, evaluation and selection of work contractors;
- construction of the building.

There are two main variations to this method (Lahdenperä, 2001, p. 22; Koppinen and Lahdenperä, 2004, p. 30; Lahdenperä, 2008, p. 13; Eastman, Teicholz, Sacks and Liston, 2011, p. 8):

CM-at-fee/Agency CM (Figure 2.7a): the construction manager is responsible for project and site management, but they are not involved in construction work. Contracts are between the client and the contractors. The construction manager monitors cost, time, quality and safety, but they do not take responsibility for them. Often large construction companies are not interested in CM-at-fee contracts, because they rather do the construction work. The construction manager is paid a fixed or time based fee for services provided.

CM-at-risk (Figure 2.7b): the construction manager is responsible for construction means and methods and delivery of the completed project, including quality and performance of the asset. All procurement is done by the construction manager and the contracts are between the construction manager and subcontractors. Still, the client keeps the final decision in project delivery. The construction manager is paid a fixed or time-based fee for services provided and construction is paid based on cost and fee or guaranteed maximum price.

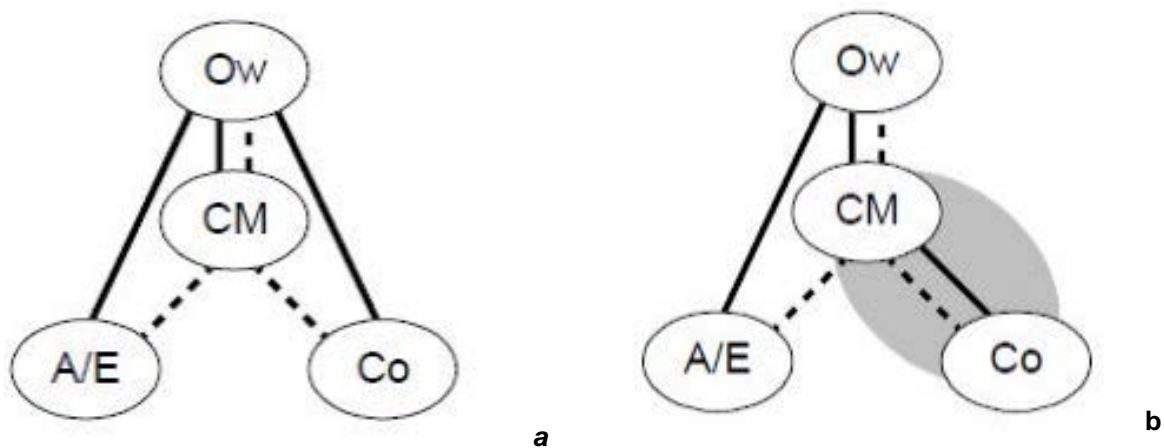

Figure 2.7. (a) Agency CM diagram (Lahdenperä, 2001, p. 22) and (b) At-Risk CM diagram (Lahdenperä, 2001, p. 22).

The main advantages and disadvantages related to this methods are:

Advantages (Turner, 1990, pp. 52–57; Eastman, Teicholz, Sacks and Liston, 2011, p. 8; Lahdenperä, 2001, pp. 21–22):

- more cost-effective product to the owner than the traditional method of project delivery, especially in complex cases, due to better consideration of the construction aspect in design and extreme price-oriented competition;
- unlike DBB, CM brings the constructor into the design process at an earlier stage where they can have definitive input. The value of the delivery method stems from the early involvement of the contractor;
- reduced liability of the owner for cost overruns;
- project are generally completed in a shorter time than traditional route projects.

Disadvantages (Turner, 1990, pp. 55–57; Koppinen and Lahdenperä, 2004, p. 30; Lahdenperä, 2001, pp. 21–22):

- even if the financial risk of the construction manager is small, the risk of loss of reputation is high;
- the client carries more risks than in DBB due to the additional risks coming from interfaces and coordination between multiple contracts and cost plus fee-type contracting;
- design and construction functions are being performed by separate entities and the possibilities of cooperation are not fully utilised;
- it is not simple to programme and define the price because the project details are not known when the appointment is made, therefore, the contractor's responsibility is general and not specific in essential detail;
- quality and cost control often appear to have lower priorities than programme;
- the flexibility during the design and construction phases may allow variations to be introduced more easily, but often this is more expensive than under traditional systems.

Client needs in-house skills in order to (Turner, 1990, p. 53):

- define their requirements;
- select a design time and a construction manager;
- carry out their responsibilities in the contract;
- take part to whatever degree they wish in the approval of options which occur throughout the management of the design and construction process.

2.3.4 Design-Build-Operate (DBO)

Design-Build-Operate (DBO) is a project delivery system where the responsibility is assigned through a single contract to design, build and maintain the asset for the contract period (Lahdenperä, 2008, p. 12) (Figure 2.8). The contract may also include other services to the client or directly to users. The payment for the investment is fixed or target price-based and the client usually pays compensation as construction progresses. During operation, a maintenance fee tied to service quality is paid (Lahdenperä, 2008, p. 13). The design is always in the same package with construction since no one is willing to accept life-cycle liability for someone else's design project: efficiency incen-

tives would be weakened in any case (Lahdenperä, 2008, p. 12). This method motivates the service provider to estimate the full cost to complete the construction as soon as possible and to ensure a good quality level of the facility (Koppinen and Lahdenperä, 2004, p. 36). Moreover the client gives bidders an output specification of the service required and later the bidders provide a solution how to satisfy the client's requirements (Koppinen and Lahdenperä, 2004, p. 36). For this reason, in DBO the service provider has more risk, but at the same time they can manage the risk and add value for their own benefit (Koppinen and Lahdenperä, 2004, p. 36).

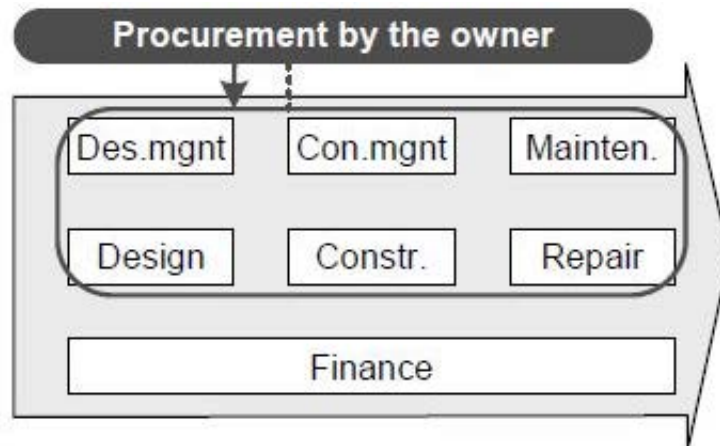

Figure 2.8. DBO diagram (Lahdenperä, 2008, p. 13).

2.3.5 Design-Build-Finance-Operate (DBFO)

Design-Build-Finance-Operate (DBFO) is a project delivery system very similar to the DBO because the responsibility is assigned through a single contract to design, build and maintain the asset for the contract period. However, the service provider arranges the financing and the client repays the investment as part of the service fee starting after commissioning (Lahdenperä, 2008, p. 12) (Figure 2.9). Also in this case the design is always in the same package with construction because no one accepts life-cycle liability for someone else's project (Lahdenperä, 2008, p. 12).

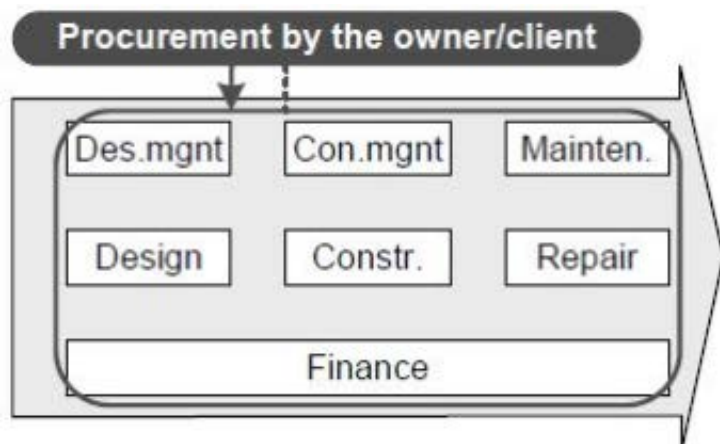

Figure 2.9. DBFO diagram (Lahdenperä, 2008, p. 13).

2.4 Innovative Procurement Procedures

Recently new types of procurement procedures are becoming popular in the AEC/FM industry to promote collaboration among the different parties involved in the process. These new approaches are very important in relation to the Building Information Modelling (BIM) adoption (more information at Chapter 3) because they facilitate its development. This paragraph shortly describes the following New Procurement Procedures:

- Integrated Project Delivery (IPD)
- Project Alliancing (PA)
- Cost Led Procurement (CLP)
- Integrated Project Insurance (IPI)
- Two Stage Open Book
- Early BIM Partnering (EBP).

2.4.1 Integrated Project Delivery (IPD)

Integrated Project Delivery (IPD) is a project delivery approach that ‘integrates people, systems, business structures and practices into a process that collaboratively harnesses the talents and insights of all participants to reduce waste and optimize efficiency through all phases of design, fabrication and construction’ (AIA, 2007a, p. 1). IPD teams usually include many experts and not only owner, designer and contractor (AIA, 2007a, p. 1), who enter into a single collaborative contract, a multi-party agreement to share risk and potential rewards (Eastman, Teicholz, Sacks and Liston, 2011, p. 200; Ilozor and Kelly, 2012, p. 28). IPD promotes a tight collaboration between all the parties involved from early design through project handover (AIA, 2007a, p. 1). Indeed, the integrated process starts at the first conceptualised phase and continues throughout the life cycle of the facility (AIA, 2007a, p. 1; Eastman, Teicholz, Sacks and Liston, 2011, p. 9). Moreover, the project team works together adopting collaborative tools to ensure that the project will be in compliance with the client’s requirements to significantly reduce time and cost (Eastman, Teicholz, Sacks and Liston, 2011, p. 9). These savings can be achieved because cost estimates are developed earlier in the design phase and contractor capabilities of constructability can inform the design process and reduce inefficiencies (Eastman, Teicholz, Sacks and Liston, 2011, p. 276). Moreover, the client and/or a consultant need to be part of the integrated team to help the management of the process (Eastman, Teicholz, Sacks and Liston, 2011, p. 9). In IPD contracts the different parties are full partners, accepting potential costs and benefits within the project; this is a revolutionary change because it potentially provides a financial mechanism for designers to benefit from any contribution of design performance to construction performance (Eastman, Teicholz, Sacks and Liston, 2011, p. 200). This approach changes design practices, project contracting, methods of delivery and of roles and the design services provided do not disappear, but rather become more articulated (Eastman, Teicholz, Sacks and Liston, 2011, p. 200).

The essential principles of IPD are mutual respect, mutual benefit, early goal definition, enhanced communication, clearly defined open standards, adoption of appropriate technology, high performance and leadership taken by persons most capable with regard to specific services (AIA, 2007a, p. 2). These principles can be applied to several contractual arrangements which promote (AIA, 2007a, p. 2):

- early involvement of key participants;
- equitably balance of risk and reward;
- have compensation structures that reward ‘best for project’ behaviour, such as ‘open book’ or incentives tied to achievement of project goals;
- clearly define responsibilities without chilling open communication and risk taking;
- implement management and control structures built around team decision making with facilitation, as appropriate.

For this reason, Design-Bid-Build is inconsistent with an integrated approach (AIA, 2007a, p. 2). Additionally, even if it is possible to achieve IPD without Building Information Modelling (BIM) (more information at paragraph 3.6), its adoption is essential to efficiently achieve the collaboration required for IPD (AIA, 2007a, p. 1; Eastman, Teicholz, Sacks and Liston, 2011, p. 9; Porwal and Hewage, 2013, p. 206; Succar, 2009, pp. 365–366; Salmon, 2012; Lahdenperä, 2012, p. 69; Raisbeck, Millie and Maher, 2010, p. 1020; Ilozor and Kelly, 2012, pp. 33–34). Indeed, ‘BIM is a tool, not a project delivery method, but IPD process methods work hand in hand with BIM and leverage the tool’s capabilities’ (AIA, 2007b, p. 10).

The American Institute of Architects (AIA) (2007b) has developed a Guide to give information and guidance on principles and techniques of IPD and to explain how to adopt IPD methodologies in designing and constructing projects.

Figure 2.10 and Figure 2.11 show the main differences between a traditional method and an integrated one.

Traditional Project Delivery	Characteristic	Integrated Project Delivery
Fragmented, assembled on “just-as-needed” or “minimum-necessary” basis, strongly hierarchical, controlled	Teams	An integrated team entity composed key project stakeholders, assembled early in the process, open, collaborative
Linear, distinct, segregated; knowledge gathered “just-as-needed”; information hoarded; silos of knowledge and expertise	Process	Concurrent and multi-level; early contributions of knowledge and expertise; information openly shared; stakeholder trust and respect
Individually managed, transferred to the greatest extent possible	Risk	Collectively managed, appropriately shared
Individually pursued; minimum effort for maximum return; (usually) first-cost based	Compensation / Reward	Team success tied to project success; value-based
Paper-based, 2-dimensional; analog	Communication / technology	Digitally based, virtual; Building Information Modeling (3,4 and 5 dimensional)
Encourage unilateral effort; allocate and transfer risk; no sharing	Agreements	Encourage, foster, promote and support multi-lateral open sharing and collaboration; risk sharing

Figure 2.10. Summary of the major differences between Traditional Project Deliver and Integrated delivery (Ilozor and Kelly, 2012, p. 29).

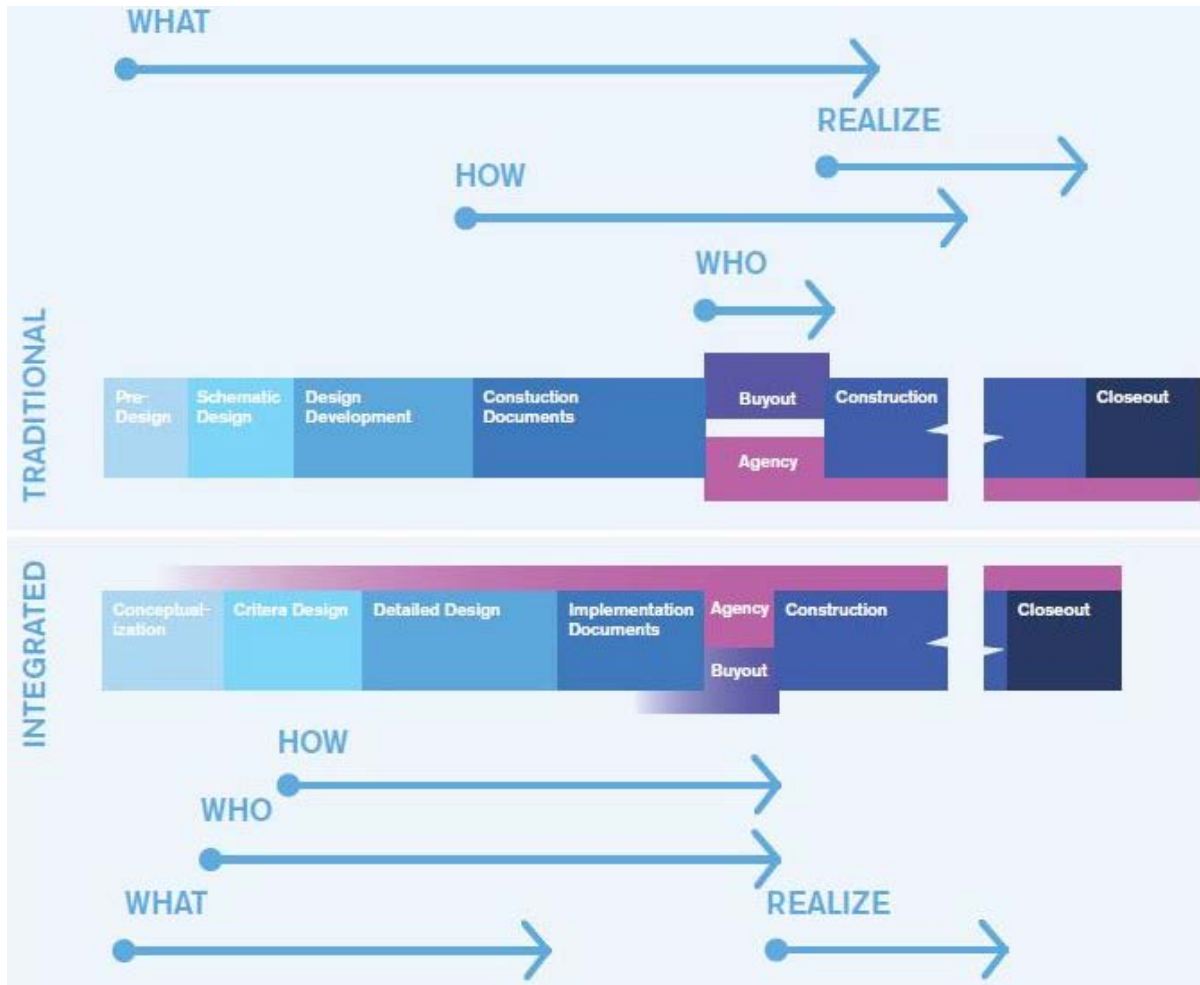

Figure 2.11. Differences in Integrated and Traditional Project Delivery (AIA, 2007a, p. 4).

2.4.2 Project Alliancing (PA)

Project Alliancing (PA), which is also called ‘Alliance Contracting’ (Lahdenperä, 2012, p. 75), is a project delivery system based on a ‘multi-party’ contract between the players involved in a project, where the parties assume joint responsibility for the design and construction to be implemented through a ‘joint organisation’, which incorporates the client and where the players share both positive and negative risks (Petäjaniemi and Lahdenperä, 2012a, p. 12; Lahdenperä, 2012, p. 58). Moreover, they observe principles of openness and information accessibility to promote collaboration and ‘no fault, no blame’ culture (Petäjaniemi and Lahdenperä, 2012a, p. 12). Petäjaniemi and Lahdenperä (2012) describe that, thanks to this approach, ‘risk is borne jointly and reward is shared on the basis of the success of the entire project’. In this way, different parties consider other’s views and cooperate more efficiently for the success of the project (Figure 2.12). Moreover, PA combines broad, versatile expertise needed to benefit the project and it improves the economic aspects of risky projects. This method needs an early selection of the parties involved, however, it is not possible to make offering services at a fixed price. Therefore, the selection is based on the review of team’s performance and capacity. The client selects tenderers, who receive a ‘Request

for Proposal'. The client analyses the tender narratives which have been submitted and reduces the number of tenderers through an assessment process including interviews. After that, only two competing teams reach the next stage involving workshop tasks, which are evaluated. In addition, the client estimates the combined team fee (including overhead plus profit) and these elements form the basis for selection of the best tender. The selected team enters in a 'development agreement' with the client for the design of the project and they agree the project's target cost. After that, the actual 'implementation contract' can be signed (Petäjaniemi and Lahdenperä, 2012a, pp. 12–13). Furthermore, Petäjaniemi and Lahdenperä (2012a, p. 15) say that PA is not for every project but it is more suitable for projects, which involve a lot of challenge, uncertainty and interfaces, because these challenges make the integration of competencies profitable.

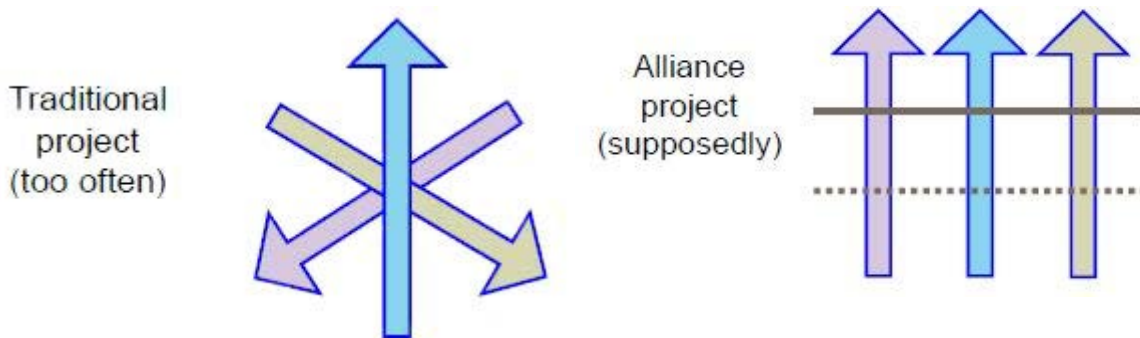

Figure 2.12. Interests of the contracting parties (Petäjaniemi and Lahdenperä, 2012b).

There are possible obstacles related to team selection, collaborative culture and value for money issues in PA (Petäjaniemi and Lahdenperä, 2012a, pp. 13–14):

Team selection:

- during early stages the project is full of uncertainty so it is difficult to estimate costs reliably. Price criteria cannot be used in selection and this makes public clients cautious;
- design proposals are not prepared and team selection is largely based on the estimated team competence which may be challenging and prone to misappraisal due to the subjective nature of measurement;
- the competition precedes the design, permitting the incoming alliance to utilise the ideas of a proposer not selected. This could be seen as unfair and thereby limit the interest of firms in entering a competition on an alliance basis.

Collaborative culture:

- successful realization of an alliance requires the players to create open and trustful relations which may be a challenge for parties having their background in the traditional 'zero-sum game', where one wins at the cost of others;
- parties to a multi-party contract enter in an agreement stating 'we shall do it together' without a clear scope of liabilities and this may not be acceptable to all stakeholders since parties carry a risk from other parties' work;

- alliance members agree to unanimous decision-making and rule out litigation or arbitration although different views are likely to arise later on due to the complexity of the project and the differing fundamental interests of the parties.

Value for money:

- due to the one-off nature of the projects and lack of price competition proving 'value for money' is challenging which may be a problem when it comes to probity auditing and could weaken public support for the adoption of the method;
- the target cost is negotiated only after the selection and joint design, and therefore, despite the open accessibility of cost information, the approach may not expose all cost items unambiguously and in a fail-safe way;
- the parties to an alliance form a joint organisation which may become a challenge due to lack of skilled people on the client's side as a result of downsizing of client organisations and increasing outsourcing of their duties.

Moreover Petäjaniemi and Lahdenperä (2012b) underline another relevant fact; PA has been developed in Australia and there are two aspects, which are not in line with European Union legislation (European Parliament, 2004):

- there is no need to use price in comparison;
- there is no need to write out verbal comparison about every comparison criteria.

However, the EU legislation (European Parliament, 2004) affirms that the price should be part of the criteria, when contracting authority is making comparison of tenders, since it is possible to adopt only two possible selection criteria: (a) the lowest price or (b) the most economically advantageous tender. However, PA can be attributed to the second option, 'the most economically advantageous tender', overcoming the missing legislation framework to efficiently support PA adoption.

Other important issues, which can limit the PA adoption in some countries, is the joint risk-sharing and liability among the Public Administration and other contracting parties for the design and construction of the project. Indeed, in Italy the Public Administration has to be excluded from all possible risks arising from the design and execution of public procurements (sections 111 and 129 of D.Lgs, 12 April 2006, n. 163, which states that the designer and contractor have to submit an insurance policy to free the Public Administration from all the designing and contract-execution risks).

2.4.3 Cost Led Procurement (CLP)

In 2011 the UK Government introduced a Construction Strategy (Cabinet Office, 2011) to improve the current situation with several initiatives (look paragraph 3.5.2). One of these initiatives is the trial of new procurement models, which 'embrace early contractor involvement, higher levels of integration and transparency and the option of independent assurance' and emphasise the need for improved client's capability (Cabinet Office, 2012, p. 4). The aim of the new models concerns the cost reduction of construction to the public sector, and thus to the taxpayer (Cabinet Office, 2012, p. 4). Moreover, they will contribute to improve the programme certainty, reduce risk, promote innovation, as well as improve relationships throughout the supply chain (Cabinet Office, 2012, p. 4).

The first UK new model of procurement is the Cost Led Procurement (CLP). This method is presented in the 'Construction Trial Projects' document (Cabinet Office, 2012, p. 4). CLP suggests that the client sets a challenging but realistic cost ceiling (Udom, 2012c) and engages one or more integrated supply chain teams in a framework agreed (encompassing designers, constructors, specialist suppliers and manufacturers) (Cabinet Office, 2012, p. 4). The client selects the teams evaluating their ability to 'work in a collaborative environment to deliver below the cost ceiling on the first project through continuous improvement and achieve cost reductions on subsequent projects while maintaining the required quality outcomes' (Cabinet Office, 2012, p. 4). The client sets an early market engagement and through a competition, 2–3 integrated framework supply teams can early develop their bids with the client team (Cabinet Office, 2012, p. 4). In this way the teams can bring their experience to introduce innovative solutions and cut cost. If at least one of the supply teams can beat the ceiling price, it is 'then selected on the relative scored attractiveness of its commercial and physical proposition and of its team members before being awarded the contract to deliver the project' (Cabinet Office, 2012, p. 4). If none of the teams is able to deliver the work, the project is given to other suppliers outside the framework (Cabinet Office, 2012, p. 4).

2.4.4 Integrated Project Insurance (IPI)

The Integrated Project Insurance (IPI) is the second new procurement method suggested by the UK Government Construction Strategy (Cabinet Office, 2012, p. 5). The UK strategy is based on a more collaborative culture in the industry but the current framework does not support this approach (*Construction Manager*, 2012b, p. 24). Indeed, construction team members usually adopt a 'cautiously defensive attitude to protect their positions and avoid invalidating their own insurance policy cover for potential claims' and these policies, in case of an issue or problem in the project, lead the parties involved to take adversarial positions (*Construction Manager*, 2012b, p. 24). IPI, instead, promotes pain-gain sharing and the parties involved are in effect partnering to some degree (*Construction Manager*, 2012b, p. 24). This method considers that the client holds a competition to determine the members of an integrated project team, including designers, special sub-contractors and key suppliers (*Construction Manager*, 2012b), which will be responsible for delivery of the project (Cabinet Office, 2012, p. 5). It will be delivered under a new form of insurance that covers cost overruns up to an agreed liability cap (Cabinet Office, 2012, p. 5). The project is supported from the beginning with an assurance team which ensures the right project cost plan has been agreed (Cabinet Office, 2012, p. 5). Indeed, in this method there is a rigorous third party verification process to keep good value in the project and to certify that a balanced commercial position has been struck (Udom, 2012c). Moreover, the assurance team monitors and reports to the insurer on the key project risks including the levels of integration achieved by the team (Cabinet Office, 2012, p. 5). The scoring may include elements related to competence, capability, proven track record, maturity of behaviours and fee declaration (Cabinet Office, 2012, p. 5). The unique aspect of this method is that a single insurance policy covers all the risks associated with the project (Udom, 2012c). In this way, a single policy covers all insurance policies, which in other projects are held by the client, contractor and the supply chain (Udom, 2012c). The winner team, then, sets up a preferred solution in compliance with the client's requirements,

with savings against existing cost benchmarks (Cabinet Office, 2012, p. 5). ‘Each team member’s maximum liability will equate to its individual excess under the IPI policy, with the maximum total liability equating to the total excess. In theory this means that each member of the team knows their maximum exposure is limited to their pre-agreed share of the excess and so does not need to build in unnecessary contingencies’ (*Construction Manager*, 2012b, pp. 24–25). Moreover, if there is an overrun, each team will be required to pay its share of deductible (*Construction Manager*, 2012b, p. 25).

Integrated Project Insurance both involves new and well-established aspects (*Construction Manager*, 2012b, p. 24). The concept of pain-gain sharing is widespread and usually where a single project insurance is adopted, it is clear that ‘the contractor has a responsibility to manage the risk to limit mistakes and not to be perverse in making claims’ (*Construction Manager*, 2012b, p. 24). However, with IPI the purpose of pain-gain sharing as a mechanism to incentivise the contractor is uncommon (*Construction Manager*, 2012b, p. 24). Target pricing is also common, but at a project level there is never been a denoting link to insurance, for this reason it is a new issue for construction managers. Nowadays, ‘a contractors all risks policy would operate somewhere in the background, but with IPI construction managers will be dealing regularly with the insurer’s technical and financial advisers’ (*Construction Manager*, 2012b, p. 24). Another issue is that designers’ project insurance usually runs annually and it is linked to their claims history and the sectors they operate in (*Construction Manager*, 2012b, p. 24). For this reason a designer would not be able to ‘switch off’ its premiums for the IPI project so they will end up paying double (*Construction Manager*, 2012b, p. 24). Similar systems of advisers are available on Public Private Partnership (PPP) projects, and from experience this approach leads to a better-managed project (*Construction Manager*, 2012b, pp. 24–25). As a consequence, the construction industry is familiar with the various parts of IPI, but the innovation is bringing them together (*Construction Manager*, 2012b, p. 25). Moreover, one of the most significant advantages of IPI is that it eliminates the ‘need for adversarial and blame culture as excessive costs overrun is covered by insurance and all that is required for payment where such overruns occur, is evidence of loss rather than the assignment of blame’ (Udom, 2012c). Instead, to secure the insurance of the project, in IPI the team would have to present a credible proposal validated by an independent expert assurer (Udom, 2012c).

2.4.5 Two Stage Open Book

The last new procurement method proposed by the UK Government Strategy is the Two Stage Open Book (Cabinet Office, 2012, p. 5). The client sets a brief and cost benchmark and invites suppliers on an existing framework agreement to bid for a project contract (Cabinet Office, 2012, p. 5). In a first stage several teams of contractor-consultant compete for the contract and they are chosen on their capacity, capability, stability, experience and strength of their supply chain and fee (profit plus company overhead) (Cabinet Office, 2012, p. 5). In the second stage the chosen team prepares a proposal based on an open book cost which is in compliance with the client’s requirements and cost benchmark (Cabinet Office, 2012, p. 5). During the process there are independent expert stage-gate reviews to check important aspects such as appropriate definition of scope and outcomes risks (Udom, 2012c). If improvements are required, the client and the contractor are asked to review their work (Udom, 2012c). The

main aim of this model should be to further reduce supply chain bidding cost (Cabinet Office, 2012, p. 5).

2.4.6 Early BIM Partnering (EBP)

Porwal and Hewage (2013, pp. 208–210) suggest an approach for the public procurement with BIM, called Early BIM Partnering (EBP). Its main objectives are:

- to provide a structured approach for potential and willing public sector BIM users to understand current BIM capabilities and assess their BIM implementation readiness;
- to create awareness about BIM applications and their usability in different project activities and phases;
- to enable public owners to review their existing processes for implementing and utilizing BIM based design collaborations and identify the likely legal and procedural conflicts that would have arisen among their project stakeholders;
- to provide a computational framework that can be developed and implemented as an interactive computational BIM-Partnering design management tool to assist BIM manager and similar roles.

The process is featured by five stages: Planning phase, Modelling phase, Partnering award phase, Early BIM partnering phase and Construction phase (Figure 2.13).

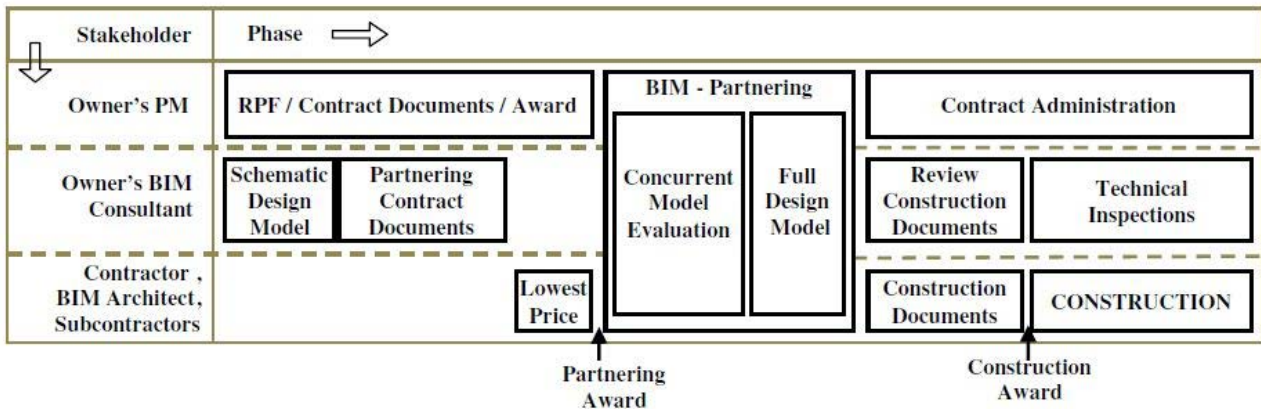

Figure 2.13. Early BIM Partnering delivery method (Porwal and Hewage, 2013, p. 208).

During the Planning phase traditional documents, such as for the DBB method, are prepared. The client and consultants establish the scope of the project and expectations of quality. Moreover, a 'Feasibility Study' may be set to study the preferred development options, prepare preliminary sketches, outline specifications and evaluate the indicative cost. Later the budget and schedule are established to get financial approvals from the competent authorities.

The Modelling phase starts when the project is approved with required funding, so the client can select and engage a BIM consultant and a corresponding design team to produce a 'Schematic Design Model' and generate contract documents. These documents are the base for the agreement between the Client and the 'Partnering Contractor', who is selected as the lowest bidder to take part in the design coordination of BIM

process. Later the client's BIM consultant and engineers work up an architectural 'Design Model' to the LOD-200, with 3D representation of the components, but not necessarily for other discipline-specific information linked to it. The 'Design Model' contains sufficient details to generate site development plans, preliminary floor plans, all major elevations of the facility, outline cross sections of any non-typical spaces or structural aspects and major materials along with architectural renderings. At this stage it is possible to develop the project using even 2D drawings along with the Building Information Model. All 2D documentation, the Building Information Model, specifications and other legal documents, form the 'Early BIM-Partnering' contract documents, which also can be used as the Request for Proposal. During the Partnering award phase the client selects a partnering contractor from a group of prequalified contractors through competitive bids and they fix a guaranteed maximum price for construction. The contractor can hire a qualified BIM design firm for the whole construction period, together with the team of qualified sub-contractors. It is no possible to change the price or schedule unless the client requests significant change in the scope or design.

The next step is the Early BIM partnering phase, where the client's project manager, client's BIM consultant, contractor's BIM designers and sub-contractors work together to generate a 'Full Design Model' for the Construction Phase. The Partnering team produces a more detailed Model based on the 'Reference Model' created in the Modelling phase. Each part independently develops its own specific model which is merged with the architectural model. The data should be sharable with other parties involved to promote collaboration. The model is analysed to support project evaluation, reduce construction conflicts and waste.

The last phase is the Construction award, where construction documents are generated from the 'Full Design Model'. After the completion of the 'Full Design Model', the client can terminate the contract by paying a previously stipulated sum to the contractor and not continue the next level of construction contract. In this way the contractor has the right to receive the money for their work and they are protected from client's wilful approach to obtain the model and complete the construction with another contractor. When the client receives the model they have the full ownership rights to the Building Information Model created in the BIM partnering phase. Client's BIM consultant is liable for any design errors and consequent damages. Afterwards the client administers the construction contract with the contractor, moreover, the client's project manager monitors the work in progress during construction phase and authorises monthly progress payments and final payments to the contractor.

2.5 e-Procurement

Regarding the Public Sector, e-Procurement is a 'collective term for a range of different technologies that can be used to automate the internal and external processes associated with the sourcing and ordering process of goods and services' (Bof and Previtali, 2010, p. 1). Public institutions have different aims towards the implementation of e-Procurement and those cannot be seen simply as extensions of commercial e-Procurement applications, because government institutions follow a wide variety of goals due to their peculiarity nature (Bof and Previtali, 2010, p. 2). Within this context the political and legislative environment in which Public institutions work, calls for conformity to a range of requirements and bureaucratic procedures which have little or nothing in common with economic output (Bof and Previtali, 2010, pp. 2–3).

Moreover, as reported by Racca (2012, pp. 3–7), the Europe public authorities spend around 19% of GDP on works, goods and services but public procurement Directives cover only a small percentage of such expenditure. Indeed, only 20% of the value of public contracts awarded in Europe is above threshold or fully within the scope of the public procurement Directives. Additionally, the ‘Evaluation Report Impact and Effectiveness of EU Public Procurement Legislation, Part 1’ (European Commission, 2011) affirms that only 4% of EU GDP is fully awarded according to the Directives and only around 2% is below thresholds, the remainder of which is not or not fully covered by the Directives so the value of this market strongly decreases. For this reason there is the need to find new solutions to create an effective internal market for EU public procurements and increase competitiveness. According to Racca (2012, p. 3) IT solutions seem to become strategic to better enforce non-discrimination and transparency principles to favour also cross border participation.

In 2012 the European Commission published ‘A strategy for e-procurement’ to present the strategic importance of electronic procurement (e-Procurement) and describe the main actions through which the Commission plans to support the transition towards full e-Procurement in the EU. According to this communication, e-Procurement can significantly simplify the way procurement is carried out, reduce waste and deliver better procurement outcomes (lower price and better quality) together with stimulating greater competition across the Single Market. Moreover, it can help to undertake two of the main challenges the European economy is facing today: the necessity to maximise the efficiency of public expenditure in a context of fiscal constraints and the need to find new sources of economic growth. e-Procurement produces both economic and environmental benefits; indeed, it is possible to reach savings between 5 and 20% (and the experience also shows that investment costs can be rapidly recouped); and also reduce paper consumption, transport and need for costly archiving space (European Commission, 2012, p. 2). This approach is in accordance with the sustainable growth objective of the EU 2020 Strategy. Moreover, the Digital Agenda for Europe and the e-Government Action Plan 2011 – 2015 underline the importance of connecting e-Procurement capabilities across the Single Market (European Commission, 2012, p. 2). However, EU is lagging behind both its own targets and internationally; instead e.g. in Korea a full online procurement market place has already been achieved and in Brazil 80% of public procurement is carried out electronically (European Commission, 2012, p. 2). There is an authentic proposal to modernise the EU's public procurement legal framework as anticipated in the 2011 Single Market Act and one aspiration of these proposals is to achieve a full transition to e-Procurement in the EU by mid-2016. Additionally, the ultimate goal is ‘straight through e-procurement’ with all phases of the procedure from notification (e-notification) to payment (e-payment) being conducted electronically (European Commission, 2012, p. 3). According to European Commission (2012, p. 3) there will be significant efficiency gains thanks to e-Procurement such as cost reductions by lowering the price that the public sector pays to acquire goods, services and works; and by reducing transaction costs both for the public sector and for economic operators (also by reducing the duration of procurement procedures). Moreover, there will be improvement of the transparency and greater access to procurement opportunities, thus stimulating innovation, competition and growth in the Single Market. e-Procurement can also reduce error rates (e.g. by avoiding the necessity to frequently encode paper-based information in IT systems at different phases of the procurement

procedure). Analyses carried out by the European Commission suggest that the price reduction in public procurement can have a macro-economic impact and the GDP could rise by up to 0.1 to 0.2% after 5 years (European Commission, 2012, p. 3). However, there are still some barriers to overcome such as the 'inertia' demonstrated by certain stakeholders. The challenge is to convince doubtful purchasers and suppliers to change their deep-rooted habits and persuade them that the predicted benefits are attainable and that investments can be recouped in a reasonable term. Additionally, the market fragmentation deployed across the EU can lead to increased costs for economic operators (European Commission, 2012, p. 5). On the contrary, the technology to conduct e-Procurement is ready to be used, so there are no technological limitations but most of them are cultural ones. To overcome these barriers, the European Commission is undertaking a number of actions both legislative and non-legislative (European Commission, 2012, pp. 7–9). The legislative measures are based on the principle of simplification to create an effective legal framework requiring full transition to e-Procurement, in order to improve interoperability between e-Procurement systems and making the e-submission phase as accessible as possible. Moreover, more attention should be paid to develop electronic identification, authentication and signatures.

The proposal on the classical sector (COM (2011) 896 final) drives a gradual transition towards full electronic tools of communication (European Commission, 2012, p. 6). These will become compulsory for some phases of the procurement process and for some actors by the transposition deadline: e.g. e-notification to Tenders Electronic Daily (TED), which is the online version of the 'Supplement to the Official Journal of the European Union' dedicated to European public procurement. It provides free access to business opportunities and it is updated five times a week with approximately 1500 public procurement notices from the European Union, the European Economic Area and beyond. Moreover, the proposal suggests that also the Central Purchasing Bodies should move to full electronic tools of communication, including electronic submission of bids (e-submission) by that date. All other contracting authorities will be asked to perform all procurement procedures adopting electronic tools of communication no later than two years after the transposition deadline, except in duly justified circumstances. The proposal also contains streamlined provisions regulating certain electronic procedures and tools, such as Dynamic Purchasing Systems, electronic auctions (e-auctions) and electronic catalogues (e-catalogues). Additionally, e-CERTIS will become a mandatory clearing house two years after the transposition deadline. It will list the certificates and statements which may be needed for qualification of a bidder in procurement and will set the equivalence criteria across Member States. This will provide greater clarity and legal certainty, especially in terms of cross-border submission, with regards to certificates and statements that may be required by Member States (European Commission, 2012, p. 6).

The non-legislative measures, instead, deal with the promotion of practical solutions based on best-practices, such as establishing an e-Tendering Expert Group to issue recommendations to promote 'best of breed' e-Procurement systems facilitating cross-border access and the publication of a report on best e-Procurement practice ('the Golden Book'). Another non-legislative strategy deals with the support of e-Procurement infrastructure development through promoting the sustainability of 'Pan-European Public Procurement On-Line' in order to develop the interoperability between already platforms in Member States. Another aim of this project is to overcome the cur-

rent barriers of electronic business attestations, which are needed in the tender phase to proof that companies are in compliance with selection criteria (Grilo and Jardim-Goncalves, 2010a, p. 109). Moreover, the 'Connecting Europe Facility' programme has been financed to support investment in deployment of infrastructure demanded to allow the delivery cross border public services (European Commission, 2012, p. 9). A dissemination strategy is going to be adopted to inform public authorities and companies about the opportunities and benefits together with the organisation of annual conference on e-Procurement. Additionally, there will be a monitoring activity of e-Procurement take-up and benefits, checking procurement expenditure in real-time and publishing an annual report. Finally, pilot projects will be performed both in pre- and post- awarding phases (European Commission, 2012, p. 11).

Vasu (2011) has prepared a summary of the main drivers and barriers in e-Procurement implementation available in literature, most of them have been already presented in the European Commission document. Indeed, the main drivers are cost and time savings together with increased quality during the overall process through greater visibility, competition, transparency and improved communication and efficiency (Vasu, 2011, pp. 20–25). On the other hand, the main barriers identified in Construction e-Procurement are resistance to change, lack of a national IT policy and technical expertise, companies' lack of internet access and IT systems, IT investment costs, bureaucratic dis-functionalities and lack of pertinent laws and contracts, lack of flexibility, security in the process and confidentiality of information, different national approaches, partial data display, external and internal compatibility (Vasu, 2011, pp. 20–25).

Even if the electronic instruments can greatly improve the effectiveness of the principle of efficiency and transparency (Racca, 2012, p. 19), nowadays e-Procurement does not cover all the phases of the process and paper-based documentation is still adopted, so more improvements are required to achieve an integrated procedure. For this reason EU Members are making efforts to achieve this goal and in March 2013 the first European Conference on e-Public Procurement has been held in order to discuss about the process of change to achieve e-Public Procurement in each country, better technologies and methodological issues such as Cloud Computing (Valadares Tavares, 2013). In EU Portugal is an exception because since November 2009 the adoption of e-Procurement for all open, restricted or negotiated public procurements has been mandatory (Costa, Arantes and Valadares Tavares, 2013, p. 238). Today there are eight electronic platforms certified by a Supervisory Board, which give general and differentiated service so the public contracting authorities can select the most suitable platform and pay a fee for the service (Costa, Arantes and Valadares Tavares, 2013, p. 240). The Portuguese market is very active and there is competition to provide better e-Procurement platform solutions (Costa, Arantes and Valadares Tavares, 2013, p. 240). Moreover the Government, together with other enterprises, is financing an important initiative called PLAGE to develop electronic platform for integrated procurement and management in construction industry (more information is available at paragraph 3.5.4). Nowadays the Portuguese Grilo and Jardim-Goncalves are one of the few who are developing e-Procurement related to construction (2010; 2010a; 2011; 2013) together with a group of UK researchers (Eadie, Perera, Heaney and Carlisle, 2007; Eadie, Perera, Heaney 2010a; 2010b; 2011; Eadie, Perera, Millar, Perera, Heaney and Barton, 2012).

A lot of work should be done also to increase the transparency and cross-border procurement for below threshold contracts (Racca, 2012, pp. 25–26). e-Procurement could promote it, not just through greater publicity of contracts, but also thanks to a certain degree of language independence and standardising certain practices, which nowadays limit cross-border participation (Racca, 2012, p. 51). Another interesting issue is the e-Procurement solution for the automatic evaluation of bids. Indeed, electronic means seem to be one of the most challenging solutions, especially in the case of the criteria of the most economically advantageous tender (Racca, 2012, p. 35). The contracting authority can specify the characteristics of the subject of the tender and give relative weighting and set mathematical formula in order to sum the scores and more objectively define the ranking (Racca, 2012, pp. 34–46). However, this approach is not valid for all the criteria, but only for the measurable ones, which can receive an automatic score (Racca, 2012, pp. 34–46). For this reason the aspects that imply an appreciation of non-quantifiable elements cannot be part of electronic auctions (e-Auction) (Racca, 2012, p. 41). This is more evident in procurement of works, than of goods and services, because it is more complex and involves several issues which are difficult to be translated in objective and measurable criteria.

Figure 2.14 shows the main phases of e-Procurement activity.

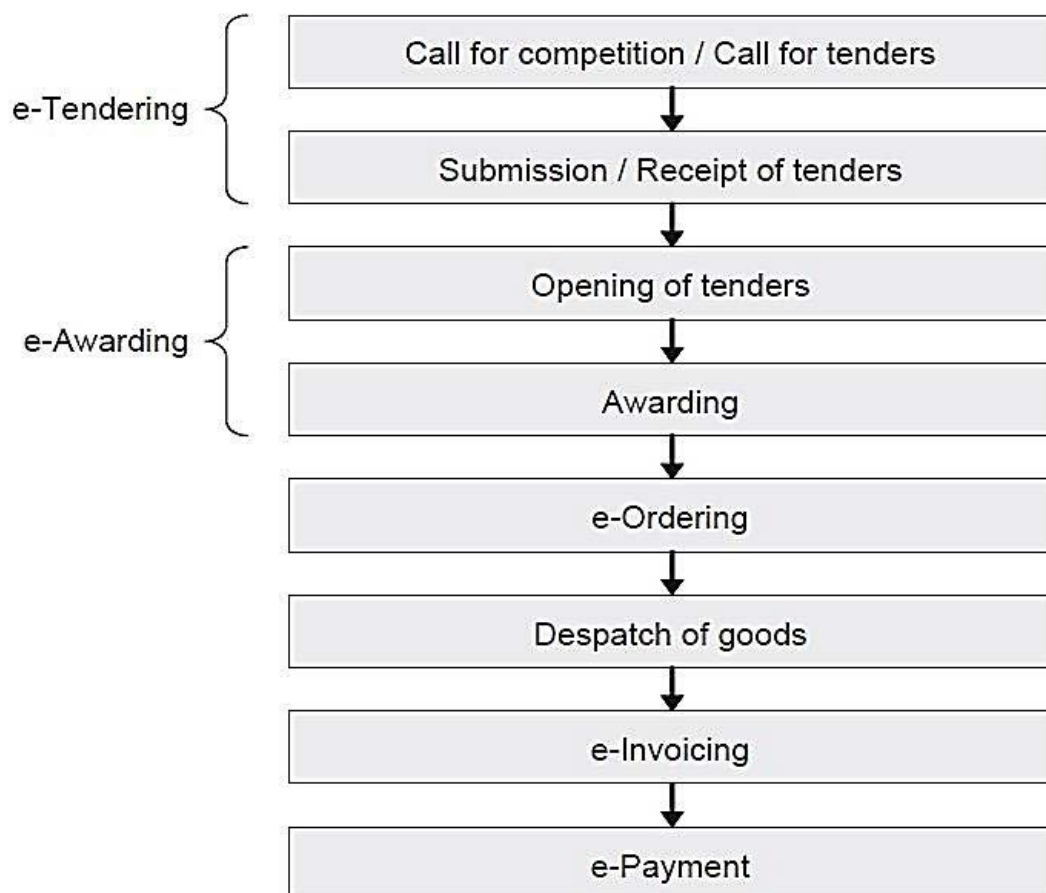

Figure 2.14. e-Procurement process (Grilo and Jardim-Goncalves, 2011, p. 109).

3. Building Information Modelling

3.1 Introduction

The aim of this chapter is to present the main concepts related to the Building Information Modelling (BIM). First the definition of BIM is given and then its current applications are discussed. Moreover, a paragraph is dedicated to the interoperability issues and another one illustrates the degree of diffusion of BIM around the world. Finally, the possibilities and challenges related to the BIM adoption are presented.

3.2 The definition of BIM

Until the mid-nineteenth century simple tools were adopted to design buildings, such as pen, paper and ruler. Later, with the invention of the computer, 2D CAD tools, such as AutoCAD, were utilised and nowadays they are the most popular tools to design (Yan and Damian, 2008). The passage from the paper based design to the 2D CAD one was an innovation in terms of saving time due to the automation of some activities. However, there was not a big improvement in the methodology, because 2D drawings do not allow to create new objects but only to do the same things (e.g. drawing circles, lines, arcs) with different tools. In the past fifteen years design tools in the AEC industry have been improved from 2D CAD drawings to 3D modelling, changing design thinking from 'pure visualization' to 'simulation' (Yan and Damian, 2008).

Nowadays a new approach called Building Information Modelling (BIM) is arising. It is an emerging technological and procedural shift within the Architecture, Engineering, Construction and Operations (AECO) industry (Succar, 2009, p. 357) to cheaper and faster increase in productivity (Saxon, 2013, p. 6). Indeed, for decades the reduction of cost and/or time entails less value of the project (Saxon, 2013, p. 6). For a long time the AECO industry has been seen as 'unfriendly to its customers, fragmented, unable to learn, self-centred, hard to buy from and with relentlessly climbing costs' (Saxon, 2013, p. 28). Moreover, low productivity and profitability due to errors and omissions in paper based documentation often occurred (Eastman, Teicholz, Sacks and Liston, 2011, p. 2). Usually in 2D-based approach analyses (such as cost estimates, energy and structural analyses) are performed at the end, when it is too late to generate big changes (Eastman, Teicholz, Sacks and Liston, 2011, p. 2). Additionally the traditional approach is characterised by inadequate respect for the ecological impact and insufficient attention to the health and safety of workers (Saxon, 2013, p. 28). The aim of BIM, instead, is to improve the overall process following the slogan 'Better! Faster! Cheaper!' (Saxon, 2013, p. 6) and embracing a revolutionary way of creating, adopting and sharing lifecycle data of a facility (Eastman, Teicholz, Sacks and Liston, 2011, p. 16) (Figure 3.1).

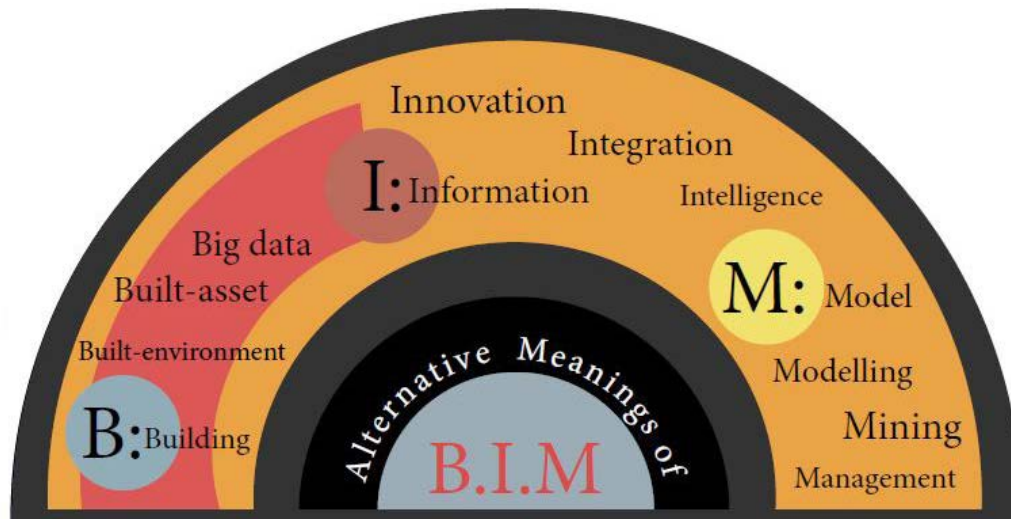

Figure 3.1. Alternative Meaning of BIM (Saxon, 2013, pp. 6–7).

Indeed, BIM describes the process of improvement and adoption of a computer generated model to simulate all the phases of a facility such as the planning, design, construction and operation (Azhar, Hein and Sketo, 2008). The Building Information Model is ‘a data-rich, object-oriented, intelligent and parametric digital representation of the facility, from which views and data appropriate to various user’s needs can be extracted and analyses to generate information that can be used to make decisions and improve the process of delivering the facility’ (Azhar, Hein and Sketo, 2008) (Figure 3.2).

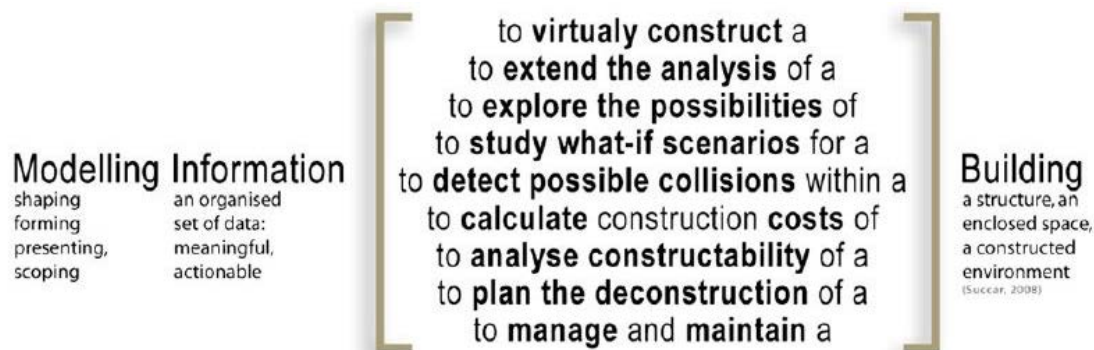

Figure 3.2. Some common connotations of multiple BIM terms (Succar, 2009, p. 359).

Actually BIM covers all the functions of 3D models (Eastman, Teicholz, Sacks and Liston, 2011, p. 15), but its objects are not only simple 3D ones: they are ‘smart’ because they contain useful data for different stakeholders (Succar, 2009, p. 363). BIM is not merely collections of graphical entities such as points, lines, 2D shapes and 3D volumes (Yan and Damian, 2008), but it embraces a larger field where objects are defined as building elements and systems such as spaces, walls, beams, slabs (Azhar, Hein and Sketo, 2008). For this reason the most important part of BIM is not the ‘Building’, also because this method can be applied to other fields such as the Infrastructure (Saxon, 2013, p. 8; Furneaux and Kivvits, 2008, p. 4). Neither the ‘Model’ is the most important, because BIM does not utilise just 3D visualisation, which can be reached thanks to soft-

ware such as AutoCAD or SketchUP. The 'Information', instead, is the 'diamond point' of the BIM process, because it can be shared and communicated through the all parties involved and it is created once and it can be re-used many times during the overall lifecycle of the building (Furieux and Kivvits, 2008, p. 4).

Nowadays a lot of people are involved in the overall process (Figure 3.3) and it is not always simple to manage and coordinate them (Eastman, Teicholz, Sacks and Liston, 2011, p. 3).

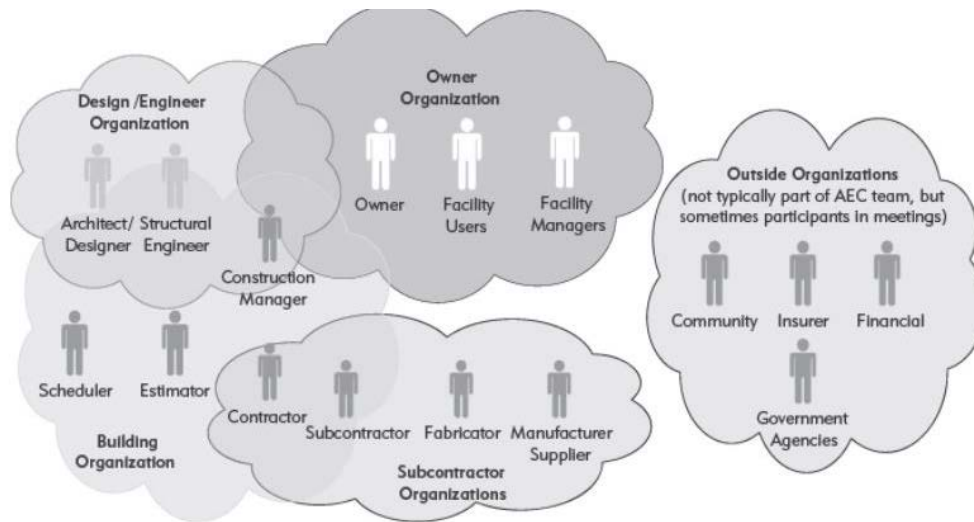

Figure 3.3. AEC project team and typical organisation boundaries (Eastman, Teicholz, Sacks and Liston, 2011, p. 3).

The aim of BIM is to integrate and coordinate the people involved to simplify the workflow (Figure 3.4).

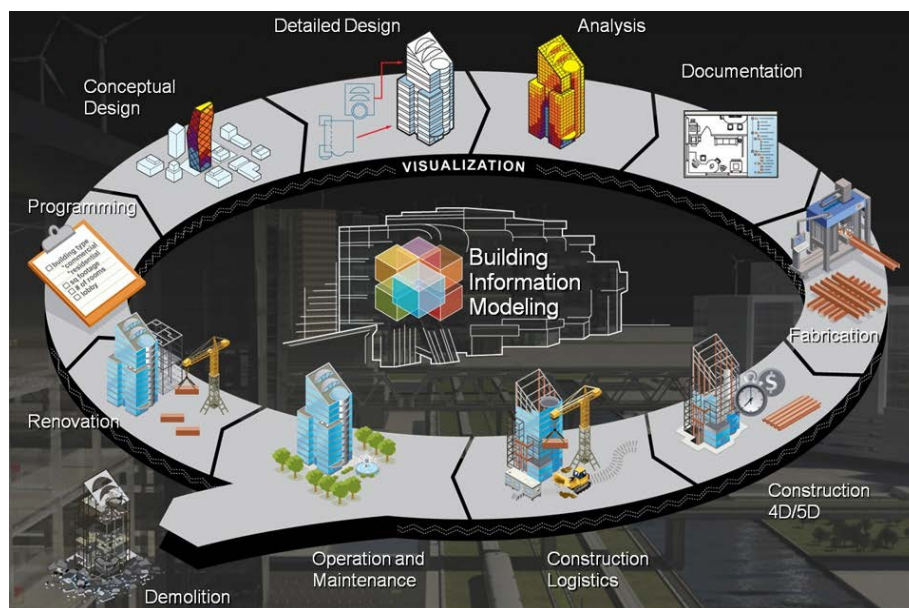

Figure 3.4. The BIM integrated process. Available at <http://buildipedia.com/aec-pros/design-news/the-daily-life-of-building-information-modeling-bim?print=1&tmpl=component> (last visit 15 June 2013).

Succar (2009, p. 359) defines three fields of activity related to BIM: Technology, Process and Policy. The Technology field contains all the people who work in the development of software, hardware, equipment and networking systems useful for the AECO industry. The Process field includes the players involved in the design, construction, manufacture, use, management and operation procedures, such as owners, designers, contractors and facility managers. Finally, the Policies field comprehends specialised organisations who manage the preparatory phase, the regulatory and contractual issues such as insurance companies, research centres, educational institutions and regulatory bodies. Figure 3.5 describes the three fields which are related to each other. For example the generation of open standards (more information is available in paragraph 3.4.3) needs the interaction between the Policy and the Technological players (Succar, 2009, p. 360). Additionally players of the Process field can develop guidelines related to the Policy field, instead of working only in design or contraction processes (Succar, 2009, pp. 360–361).

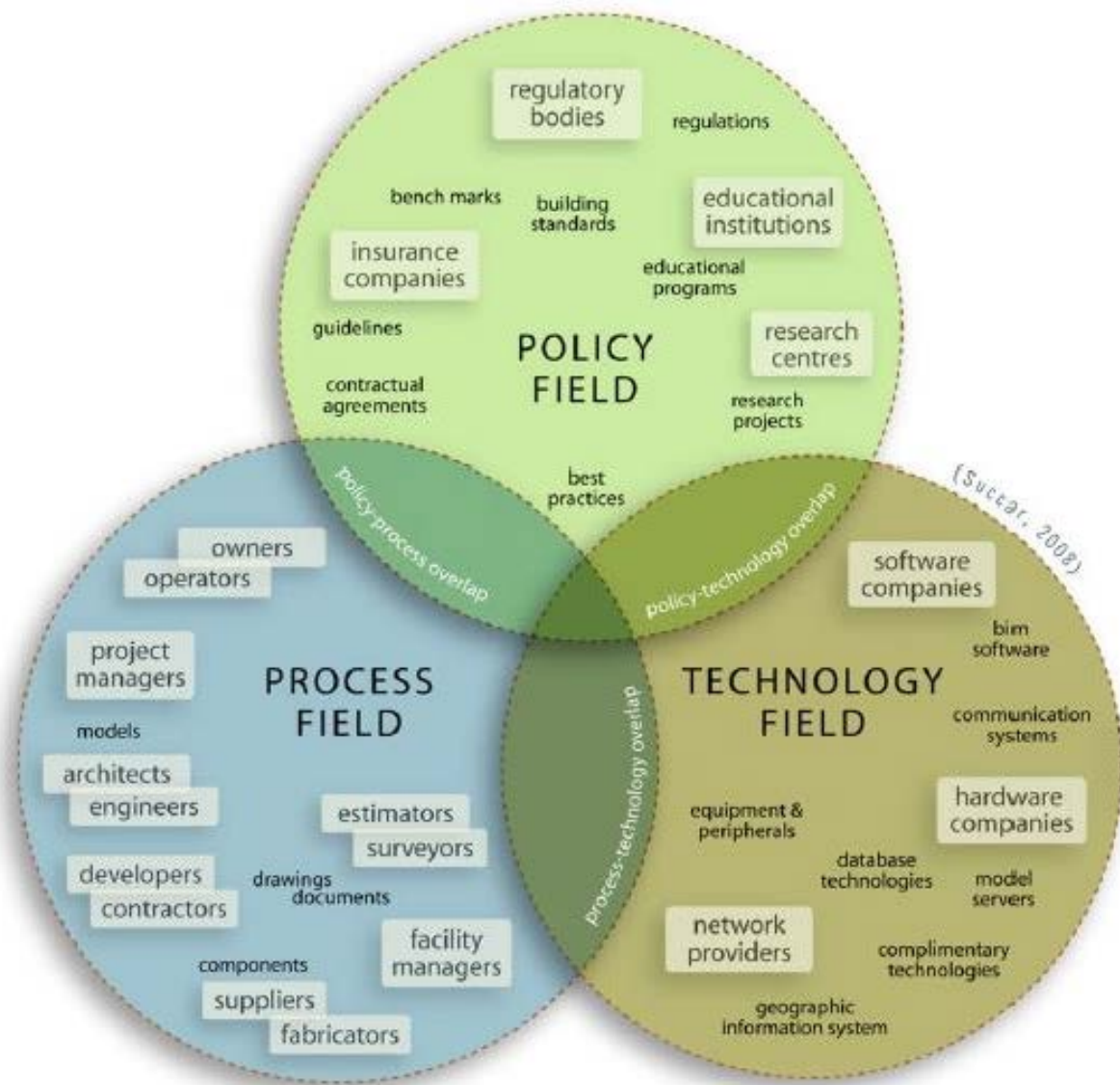

Figure 3.5. Three interlocking fields of BIM activity (Succar, 2009, p. 361).

The stakeholders have to approach the fully adoption of BIM gradually and consecutively (Succar, 2009, p. 362). Succar (2009, pp. 364–365) shows three different steps needed to fulfil this aim: modelling, collaboration and integration. These steps are preceded by a Pre-BIM situation and followed by the Integrated Project Delivery (IPD), presented in paragraph 2.4.1 (Figure 3.6 and Figure 3.7).



Figure 3.6. Stages of BIM maturity (Succar, 2009, p. 368).

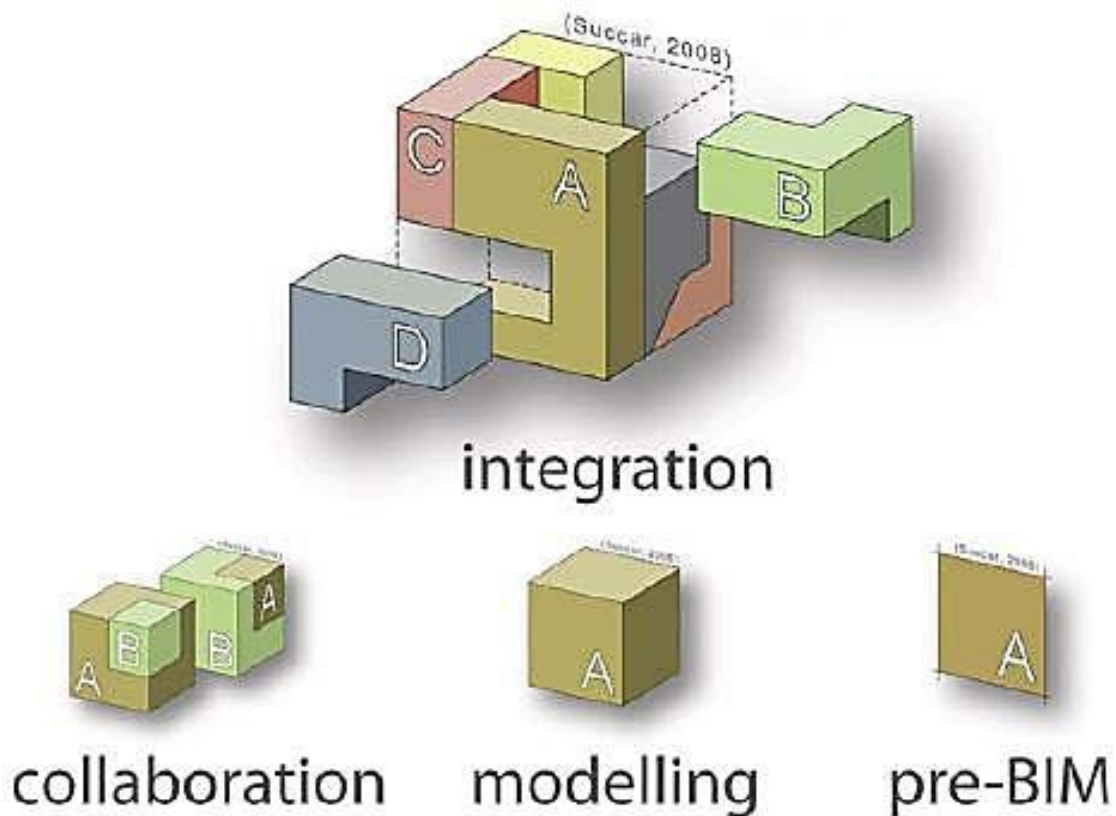

Figure 3.7. The BIM stages (Succar, 2009, p. 358).

The Pre-BIM Status is based on 2D documentation and, even if there is a 3D model, it is not utilised to extract information. Moreover, the process is usually characterised by low technology systems, lack of interoperability and low productivity (Succar, 2009, p. 364).

BIM Stage 1 is identified by object-based modelling using BIM software such as Revit, ArchiCAD and Tekla. Each discipline creates its own model and information are extracted from it, but the relationships between stakeholders are similar to the Pre-BIM Status since there is not an effective collaboration and data exchanges are only unidirectional (Succar, 2009, p. 364) (Figure 3.8).

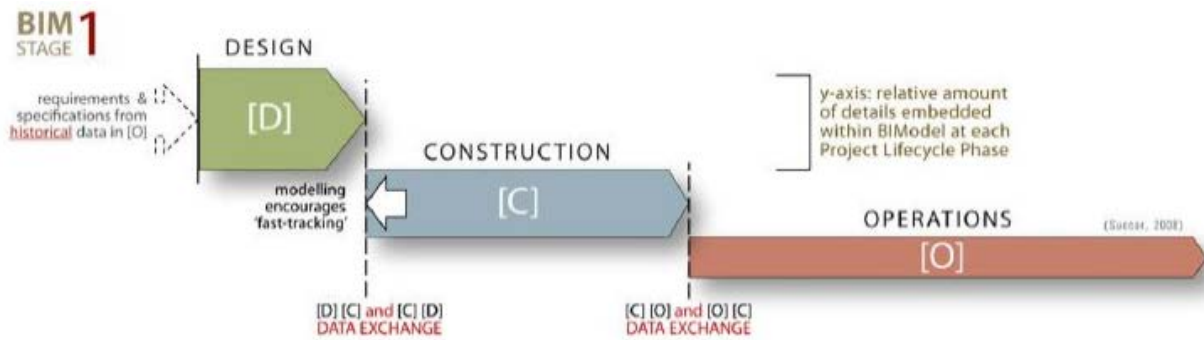

Figure 3.8. Project Lifecycle Phases at BIM Stage 1 (Succar, 2009, p. 366).

In BIM Stage 2 there is a Model-Based Collaboration between the players of different disciplines through the exchange of data in native and non-proprietary formats. The collaboration can be within one (e.g. interchanges of architectural and structural models in the design phase) or two phases (e.g. structural model and steel model between the design and the construction phases). Data are taken from one collaborating model which contains all the data and it is possible to link this information to scheduling or cost estimating database in order to generate 4D or 5D simulations. In this phase some contractual amendments start to be necessary because the demarcation of rules, disciplines and lifecycle phases is going to disappear, although the communications between the stakeholders are still asynchronous (Succar, 2009, pp. 364–365) (Figure 3.9).

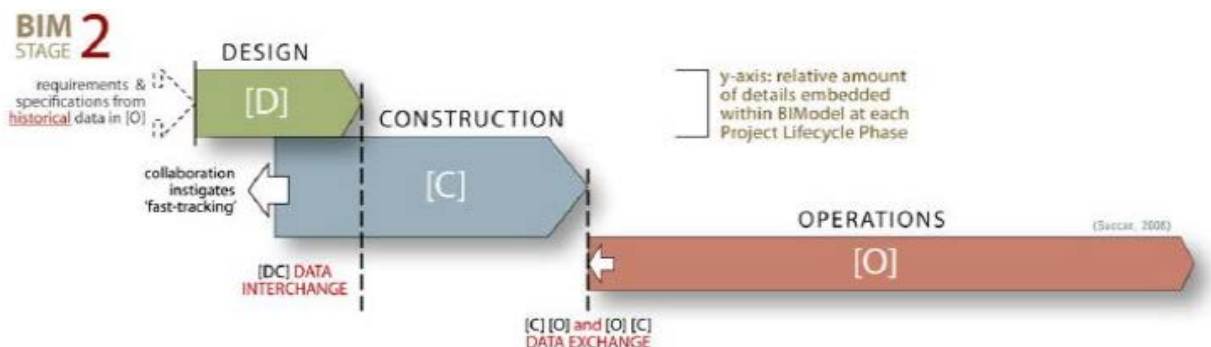

Figure 3.9. Project Lifecycle Phases at BIM Stage 2 (Succar, 2009, p. 366).

Network-Based Integration is the base of BIM Stage 3, where nD models are shared during the overall process thanks to network and software technologies to maximise the productivity. New contractual agreements, risk allocation models and procedural flows are needed at this stage (Succar, 2009, p. 365) (Figure 3.10).

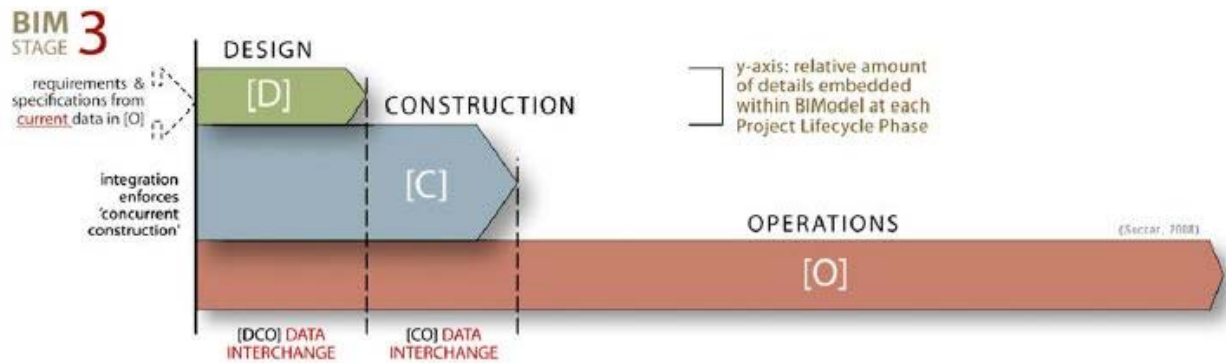

Figure 3.10. Project Lifecycle Phases at BIM Stage 3 (Succar, 2009, p. 367).

Finally, Succar suggests that IPD can be ‘suitable for representing the long-term vision of BIM as an amalgamation of domain technologies, processes and policies’ because it is seen as an effective integrated method to manage the lifecycle of a facility (2009, p. 365). The passage from one stage to the next one is characterised by gradual improvements of the three fields previously described (technological, process and policy), as shown in Figure 3.11 (Succar, 2009, p. 366).

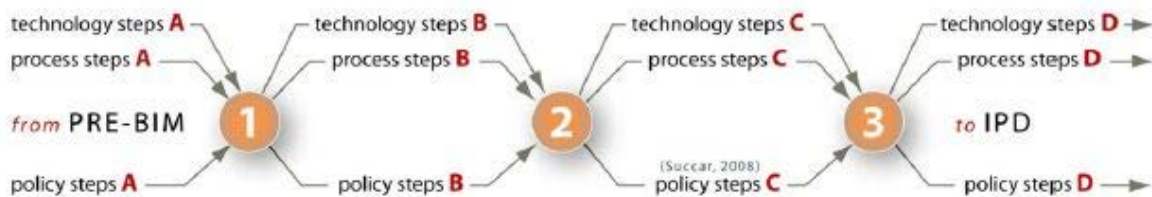

Figure 3.11. Stages and steps of BIM maturity (Succar, 2009, p. 368).

Also the UK Government has defined a BIM maturity index from level 0 to 3 (Figure 3.12), to categorise types of technical and collaborative processes related to the BIM adoption.

Level 0 is paper-based and it is characterised by 2D CAD drawings.

Level 1 introduces the adoption of the 3D format, in addition to 2D data, following the British Standard BS1192:2007, ‘Collaborative production of architectural, engineering and construction information. Code of practice’. However, the model is created only for visualisation purpose and information is not shared.

Level 2 introduces BIM models for each discipline. Data are shared between the parties involved and 4D and 5D models are adopted in the process. However, it is possible that the full potentials of data may not have been realised at this level.

Level 3 is the higher level of the index and it is characterised by an Integrated BIM process where openBIM data are shared during the overall lifecycle of the facility thanks to web services (Department of Business, Innovations and Skills, 2011, pp. 16–17).

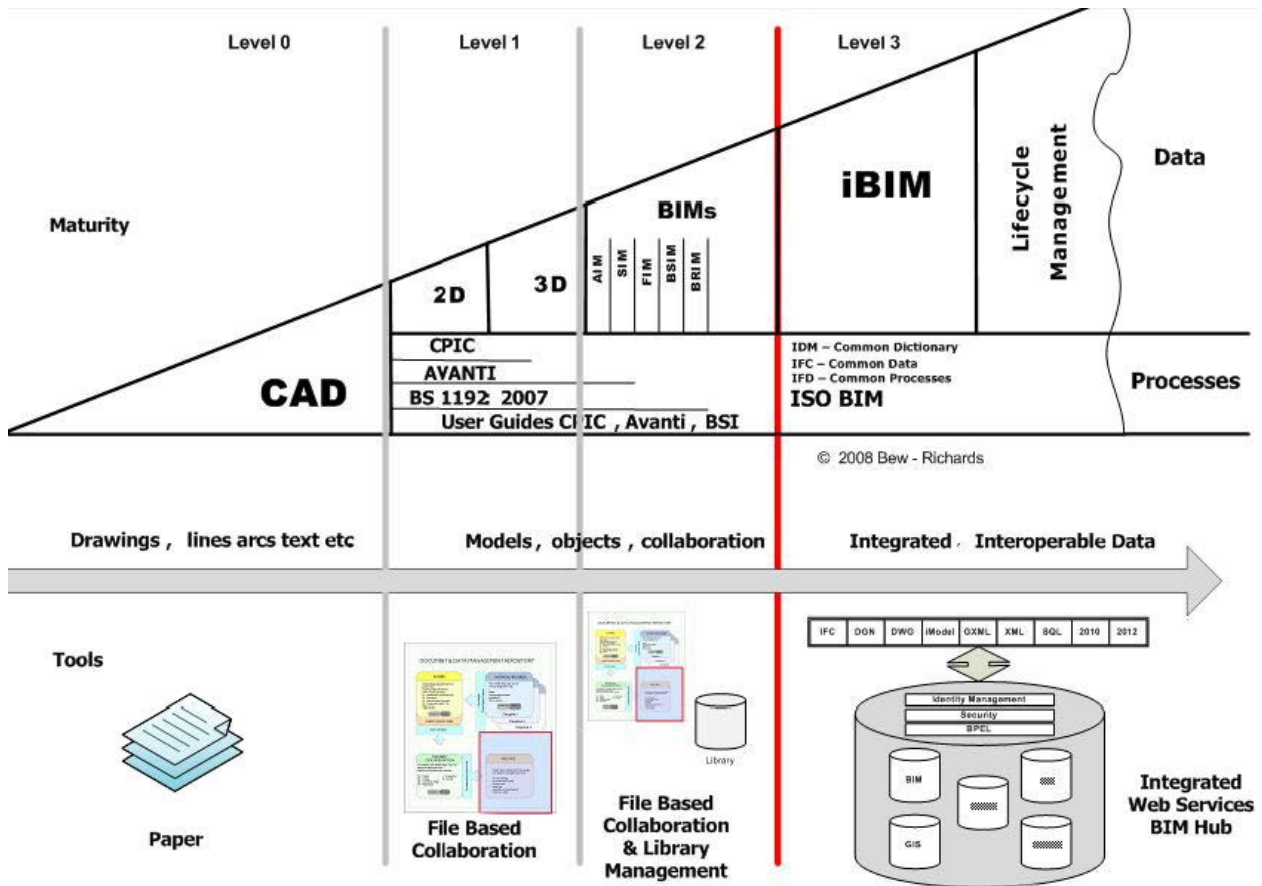

Figure 3.12. BIM Maturity Levels (Department of Business, Innovations and Skills, 2011, p. 16).

It is important to underline that BIM is not a goal but a tool, and to utilise a tool efficiently the goal must be clear (Kiviniemi, 2013). Indeed, BIM requires planning and organising the work before practical actions are taken. For this reason Model Development Specification (MDS) have been elaborated to define ‘the amount, type, and precision of information that is to be included in Building Information Models (BIMs) for specific project milestones and deliverables as the project progresses from concept to closeout’ (Bedrick, 2013b, p. 1). The MDS is useful to know the content and the schedule of BIM data in order to improve the coordination and it is a fundamental part of any BIM Execution Plan (Bedrick, 2013b, p. 1). An important part of the MDS is the Level of Development (LOD), which have been originally defined by the AIA (2008). Later also the BIMForum, an organisation which comprises participants from all the sectors of the AEC industry, has developed its Level of Development Specification (BIMForum, 2013). The LOD is used to describe the progression of the project moving from the concept, the generic placeholder, the specific assembly and finally arriving to the detailed assembly (Bedrick, 2013b, p. 2) (Figure 3.13).



Figure 3.13. Example of steel structure at increasing LODs (Bedrick, 2013b, p. 2).

The MDS is a matrix made by the breakdown of the building systems in the rows and the milestones in the columns. Each building part has a LOD and a Model Element Author (MEA) (such as A for Architect or E for Engineer) at each milestone (Figure 3.14).

		Milestones/Deliverables												Milestones/Deliverables											
		Conceptual				SD				DD				CD											
		50%		100%		50%		100%		50%		100%		50%		100%									
		LOD	MEA	Notes	LOD	MEA	Notes	LOD	MEA	Notes	LOD	MEA	Notes	LOD	MEA	Notes									
1	Uniformat Level																								
2	Building Systems																								
3	Level																								
4	Substructure																								
5	Foundations																								
6	Standard Foundations																								
7	Footings & Pile Caps																								
8	Strip Footings	5	100	A	200	E	200	E	300	E	300	E	300	S	300	S									
9	Spread Footings	5	100	A	200	E	200	E	300	E	300	E	300	S	300	S									
10	Pile Caps	5	100	A	200	E	200	E	300	E	300	E	300	S	300	S									
11	Foundation Walls																								
12	Foundation Walls - CIP	5	100	A	200	E	200	E	300	E	300	E	300	S	300	S									
13	Foundation Walls - CMU	5	100	A	200	E	200	E	300	E	300	E	300	S	300	S									
14	Foundation Walls - Wood	5	100	A	200	E	200	E	300	E	300	E	300	S	300	S									
15	Perimeter Drainage																								
16	Footings Drains	5	100	A	100	E	200	E	200	E	200	E	200	S	200	S									
17	Perimeter Insulation																								
18	Perimeter Insulation - Rigid	5		A	100	E	100	E	100	E	100	E	100	S	100	S									
19	Special Foundations																								
20	Pile Foundations																								
21	Piles - CIP	5	100	A	200	E	200	E	300	E	300	E	300	S	300	S									
22	Piles - Precast Concrete	5	100	A	200	E	200	E	300	E	300	E	300	S	300	S									
23	Piles - Steel Pipe	5	100	A	200	E	200	E	300	E	300	E	300	S	300	S									
24	Piles - Steel H	5	100	A	200	E	200	E	300	E	300	E	300	S	300	S									
25	Piles - Strap Tapered	5	100	A	200	E	200	E	300	E	300	E	300	S	300	S									
26	Piles - Treated Wood	5	100	A	200	E	200	E	300	E	300	E	300	S	300	S									
27	Grade Beams																								
28	Grade Beams - CIP	5	100	A	200	E	200	E		E	300	E	300	S	300	S									
29	Caissons																								
30	Caissons - Ball	5	100	A	200	E	200	E	300	E	300	E	300	S	300	S									
31	Underpinning	4	100	A	100	E	100	E	200	E	200	E	200	S	200	S									
32	De-watering	4	100	A	100	E	100	E	200	E	200	E	200	S	200	S									
33	Raft Foundations	4	100	A	200	E	200	E	300	E	300	E	300	S	300	S									
34	Pressure Injected Grouting	4																							
35	Pressure Injected Footings	5	NM		NM		100	E	100	E	100	E	100	S	100	S									
36	Other Special Foundation Conditions	4	NM		NM		100	E	100	E	100	E	100	S	100	S									

Figure 3.14. Example of MDS (Bedrick, 2013b, p. 2).

AIA (2008) and BIMForum define the same levels with the exception of level 350, which has been developed by the BIMForum (Bedrick, 2013a; BIMForum, 2013, pp. 8–9).

LOD 100: it is a Conceptual level where elements in the model may be graphically represented adopting a symbol or other generic representations, but they do not satisfy the requirements for LOD 200. The information related to elements (such as the cost per square foot, tonnage of HVAC) can be extracted from other elements in the model.

LOD 200: it represents Generic Placeholders where elements are graphically represented as a generic system, object or assembly with approximate quantities, size, shape, location and orientation. It is possible to attach non-graphic information to elements.

LOD 300: it defines Specific Assemblies where elements are graphically represented as a specific system, object or assembly in terms of quantity, size, shape, location and orientation. Moreover, it is possible to attach non-graphic information to elements.

LOD 350: it describes the Detailed Assemblies where elements are graphically represented as a specific system, object or assembly in terms of quantity, size, shape,

orientation and interfaces and potential interferences with other building systems. Also in this case non-graphic information may be attached to elements.

LOD 400: it defines the Fabrication Details where elements are graphically represented as a specific system, object or assembly that is accurate in terms of size, shape, location, quantity and orientation with detailing, fabrication, assembly and installation information. Moreover, it is possible to attach non-graphic information to elements.

LOD 500: the elements in the model are a field verified representation in terms of size, shape, location, quantity and orientation. Moreover, it is possible to attach non-graphic information to elements (BIMForum, 2013, p. 9).

Finally, an important clarification about the abbreviation LOD is necessary. It means both Level of Development (Figure 3.15) and Level of Detail (Figure 3.16) but they are not synonymous (Bedrick, 2013a; BIMForum, 2013, p. 8). Indeed, the Level of Detail expresses how many details are contained in the model element, while the Level of Development defines the degree to which the geometry and the attached data of the element has been thought through, and it deals with the degree to which the project team members may rely on the information when using the model. For this reason the 'Level of Detail can be thought of as input to the element, while Level of Development is reliable output' (Bedrick, 2013a; BIMForum, 2013, p. 8).

LEVEL of DEVELOPMENT

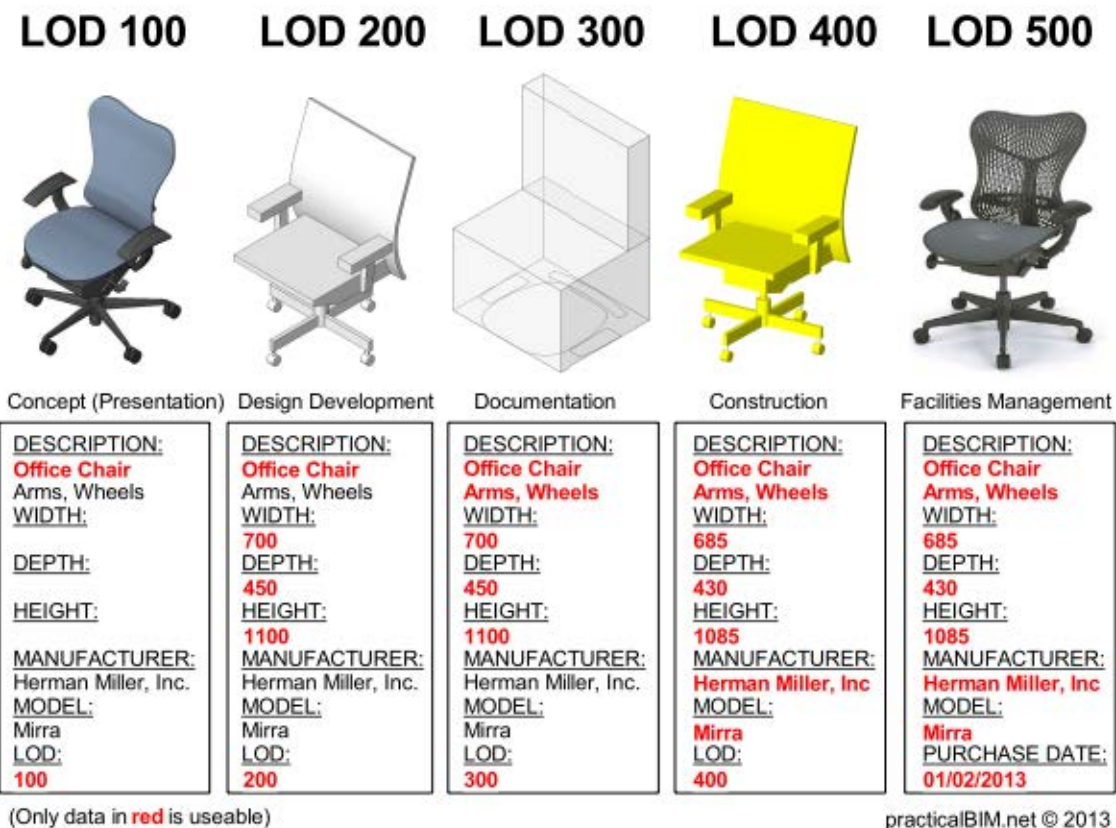

practicalBIM.net © 2013

Figure 3.15. Example of Levels of Development. Available at http://practicalbim.blogspot.com.au/2013/03/what-is-this-thing-called-lod.html?goback=gmr_68075.gde_68075_member_218542623 (last visit 1 July 2013).

LEVEL of DETAIL

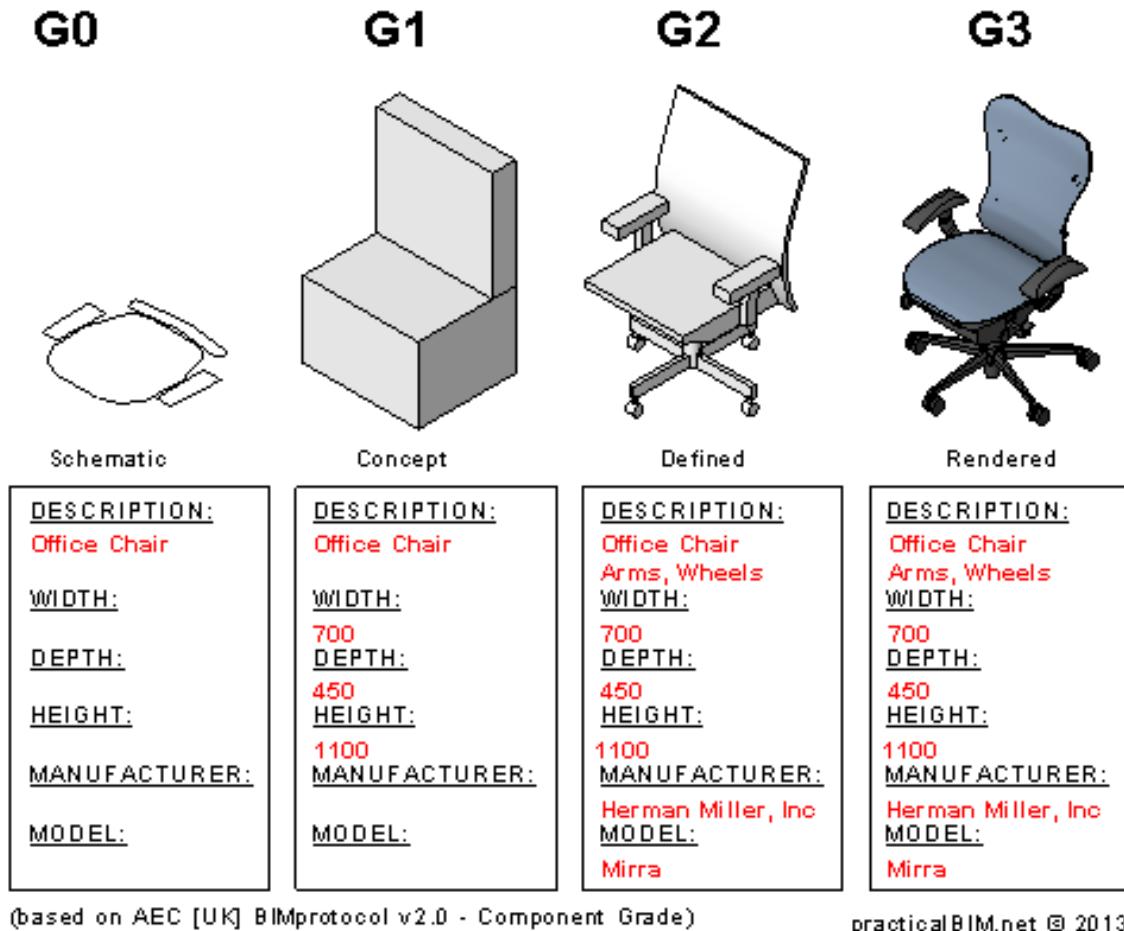

Figure 3.16. Example of Levels of Detail. Available at http://practicalbim.blogspot.com.au/2013/03/what-is-this-thing-called-lod.html?goback=.gmr_68075.gde_68075_member_218542623 (last visit 1 July 2013).

3.2.1 The history of BIM

Recently a brief history about BIM has been published by Quirk (2012) and the main steps are presented in this paragraph.

The idea of the BIM system goes back to the earliest days of computing. Indeed, in 1962, Douglas C. Englebart explained a creepy vision of the future architect suggesting object-based design, parametric manipulation and a relational database. Several design researchers' work influenced the BIM development, such as Herbert Simon, Nicholas Negroponte and Ian McHarg who was developing a parallel track with Geographic Information Systems (GIS). Christopher Alexander's work should certainly have had an impact as it influenced an early school of object oriented programming computer scientists. These systems were thoughtful and robust, but the conceptual frameworks could not be realised without a graphical interface through which to interact with Building Models.

In 1963 SAGE graphical interface and Ivan Sutherland's Sketchpad program were developed and since that moment solid modelling programs began to be improved in the computational representation of geometry. In the 1970s and 1980s two main methods of displaying and recording shape information, constructive solid geometry and boundary representation, began to appear. The constructive solid geometry system adopted a series of primitive shapes, which could be either solids or voids. This development is especially important in representing architecture as penetrations and subtractions are common procedures in design (such as for windows and doors).

An important contribution was the development of database, which helped to break-down the architecture into its constituent components, necessitating a literal taxonomy of a buildings constituent parts. One of the first projects to successfully create a building database was the Building Description System, which was the first software to show individual library elements that can be retrieved and added to a model. This program adopted a graphical user interface, orthographic and perspective views and a sortable database that allowed the user to retrieve information categorically by attributes including material type and supplier. The project was designed by Charles Eastman, who claimed that drawings for construction were inefficient and caused redundancies of one object that is represented at several scales. He also criticised hardcopy drawings for their tendency to decay over time and fail to represent the building as renovations occur and drawings are not updated. Eastman's project was funded by DARPA, the Advanced Research Projects Agency and was written before the age of personal computers, on a PDP-10 computer. Eastman's next project called Graphical Language for Interactive Design, was created in 1977 and exhibited most of the characteristics of a modern BIM platform.

In the early 1980's there were several systems implemented in UK, which gained traction and were applied to constructed projects. These include GDS, EdCAAD, Cedar, RUCAPS, Sonata and Reflex. The RUCAPS software System developed by GMW Computers in 1986 was the first program to adopt the concept of temporal phasing of construction processes and was used to assist in the phased construction of Heathrow Airport's Terminal three. In 1988 Paul Teicholz founded the Centre for Integrated Facility Engineering at Stanford and this marks another landmark in the development of BIM as this created a wellspring of PhD students and industry collaborations to further the development of 4D building models with time attributes for construction. Thanks to this improvement, two trends in the development of BIM technology would split and develop over the next two decades. On one side there is the development of specialised tools for multiple disciplines to support the construction industry and improve efficiency in construction. On the other side, instead, there is the treatment of the BIM model as a prototype that could be tested and simulated against performance criteria.

A later example of a simulation tool which gave feedback based on a model was the Building Design Advisor, developed at Lawrence Berkeley National Lab beginning in 1993. This software adopted an object model of a building and its context to perform simulations. This program was one of the first to integrate graphical analysis and simulations to provide information about how the project might perform given alternative conditions regarding the projects orientation, geometry, material properties and building systems. The program also contained basic optimisation assistants to make decisions based on a range of criteria which are stored in sets called 'Solutions'.

Beside the US, the Soviet Block had two programming geniuses, who would end up defining the BIM market as it is known today. Leonid Raiz and Gábor Bojár would go on to be the respective co-founder and founder of Revit and ArchiCAD. ArchiCAD developed in 1982 in Budapest, Hungary by Gábor Bojár, a physicist who rebelled against the communist government and began a private company. Using similar technology as the Building Description System, the software Radar CH was released in 1984 for the Apple Lisa Operating System. This later became ArchiCAD, so ArchiCAD is the first BIM software that was made available on a personal computer. The software was slow to start but it has made substantial gains in user base from 2007–2011, mainly as a tool for developing residential and small commercial projects in Europe and today Graphisoft claims that more than 1,000,000 projects worldwide have been designed using ArchiCAD. Not long after Graphisoft began to sell the first seats of Radar CH, Parametric Technology Corporation was founded in 1985 and in 1988 released the first version of Pro/ENGINEER, a mechanical CAD program. Equipped with the knowledge of working on Pro/ENGINEER, Irwin Jungreis and Leonid Raiz split from Parametric Technology Corporation and started their own software company called Charles River Software in Cambridge. Their aim was to create an architectural version of the software, which could handle more complex projects than ArchiCAD. By 2000 the company had developed a program called 'Revit', written in C++. In 2002, Autodesk purchased the company and began to heavily promote it in competition with its own object-based software 'Architectural Desktop'.

Revit revolutionized the world of Building Information Modelling by creating a platform, which adopted a visual programming environment for creating parametric families and allowing for a time attribute to be added to a component to allow a 4D of time to be associated with the building model. One of the earliest projects to use Revit for design and construction scheduling was the Freedom Tower project in Manhattan. This project was completed in a series of separated but linked BIM models, which were tied to schedules to provide real-time cost estimation and material quantities.

In the past seven years there has been a development of software, which can be adopted for both architectural design, structural and mechanical projects. This approach increases collaboration and support integrated project delivery where many disciplines typically work on a mutually accessible set of BIM models. A central file takes an object and applies an attribute of ownership so that a user who is working on a given project can view all objects but can only change those that they have checked out of a 'workset'. This feature released in Revit 6 in 2004, enables large teams of architects and engineers to work on one integrated model, a form of collaborative software. Moreover, to facilitate the exchange of data from one BIM program to another, International Foundation Class (IFC) file format was developed (more information is available at paragraph 3.4).

Following in the footsteps of the Building Design Advisor, simulation software, such as Ecotect, Energy Plus, IES and Green Building Studio, allow the BIM model to be imported directly and results to be gathered from simulations. In late November 2012, the development of formit, an application that allows the conceptual beginnings of a BIM model to be started on a mobile device, is a leap for the company.

Some have taken a negative attitude on BIM and parametric as they assume so much about the design process and limit any work produced to the user's knowledge of the program. BIM favour designers who can manage software to express their idea and

penalise those who cannot use them. Some BIM platforms that have a small market share but have made big impacts on the world of design include Generative Components, developed by Bentley Systems in 2003. The Generative Components system is focused on parametric flexibility and sculpting geometry and supports NURBS surfaces. The interface hinges on a node-based scripting environment which is similar to Grasshopper to generate forms. Digital Project is a similar program, developed by Gehry Technologies around 2006 based on CATIA, a design program. These two platforms have spawned something of a revolution in design generating complex and provocative architectural forms. Patrick Schumacher has coined the movement of parametric building models in architecture, specifically those which allow for NURBS surfaces and scripting environments as ‘parametricism’ in his 2008 ‘Parametricist Manifesto’. These techniques have become increasingly complex and architectural schools are specified to train in specific software. Additionally, the programmers who worked on the early BIM platforms often did not have a background in architecture but employed hybrid architect/programmers who contributed to the development of the programs. One notable exception is the work of Charles Eastman who received a Masters of Architecture from Berkeley before working on the Building Description System.

The industry has only begun to realise the benefits of BIM so its implementation is still in an infancy phase. Nowadays the BIM adoption is increasing and trends in Human Computer Interaction, Augmented Reality, Cloud Computing, Generative Design and Virtual Design and Construction are influencing its development.

3.3 Current BIM Authorised Uses and Permitted Purposes

Thanks to its cross nature, BIM has several applications in the AECO industry. A list of applications follows.

Design of the Building: BIM is adopted to design the Architectural, Structural and MEP parts of the facility (Figure 3.17) in addition to the surrounding area (COBIM, 2012, Series 2–5).

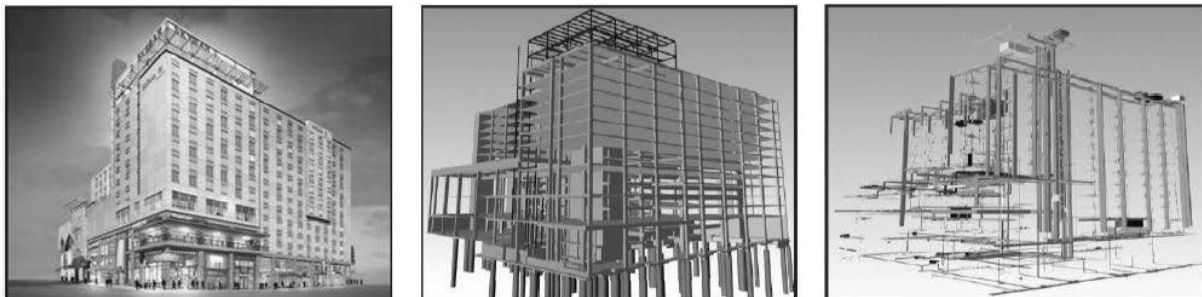

Figure 3.17. Architectural, Structural and MEP models (Azhar, Hein and Sketo, 2008).

Coordination: different software can be adopted to create objects of different disciplines and at the end they can be merged to find possible conflicts (Figure 3.18), however, a better solution is to work on linked models from the beginning, for example adopting cloud computing technology, moving up the identification of inconsistencies.



Figure 3.18. Merging of BIM models (COBIM, 2012, Series 6, p. 7).

Extraction of 2D drawings: whenever during the design process, 2D drawings can be extracted from the model (Figure 3.19) and the designer is sure that they are always updated and coherent (COBIM, 2012, Series 13, p. 5).

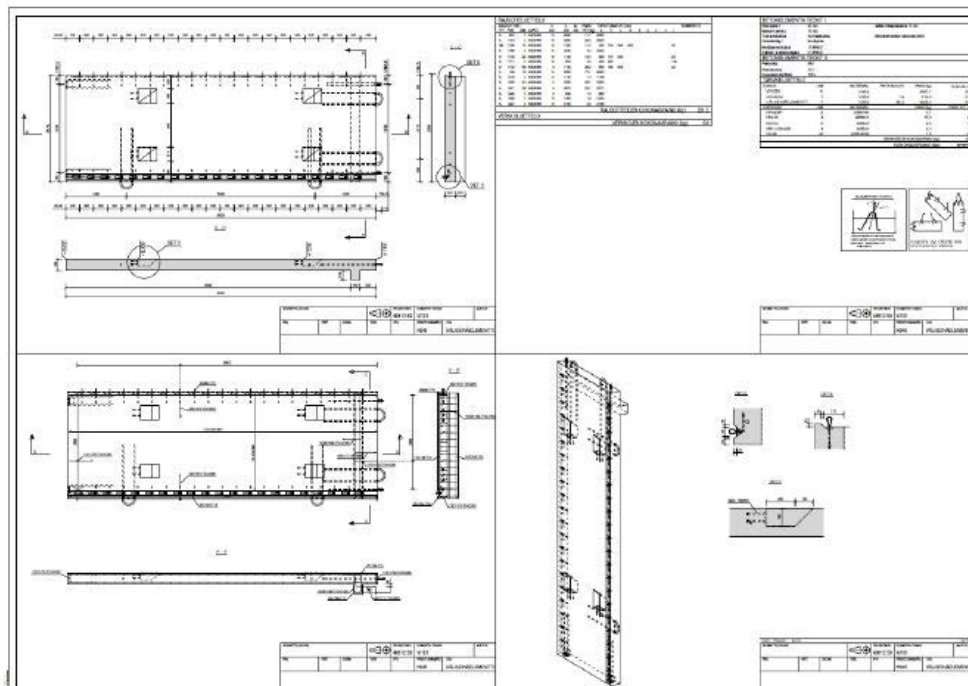

Figure 3.19. 2D drawings extracted from the model (COBIM, 2012, Series 5, p. 14).

Visualisation and Communication: the 3D model is very useful for a better understanding of the design solutions both for designers of the same discipline but also for different stakeholders who are not familiar with other experts' work (Barker, 2011) (Figure 3.20a). It is possible to walk through the model, create animations and see 3D images or rendering (Figure 3.20b) taken from the model (COBIM, 2012, Series 8). Moreover, BIM can help the estate agents to sell homes through a strong visualisation and the buyers are able to easily customise the design of the house (Saxon, 2013, p. 49).

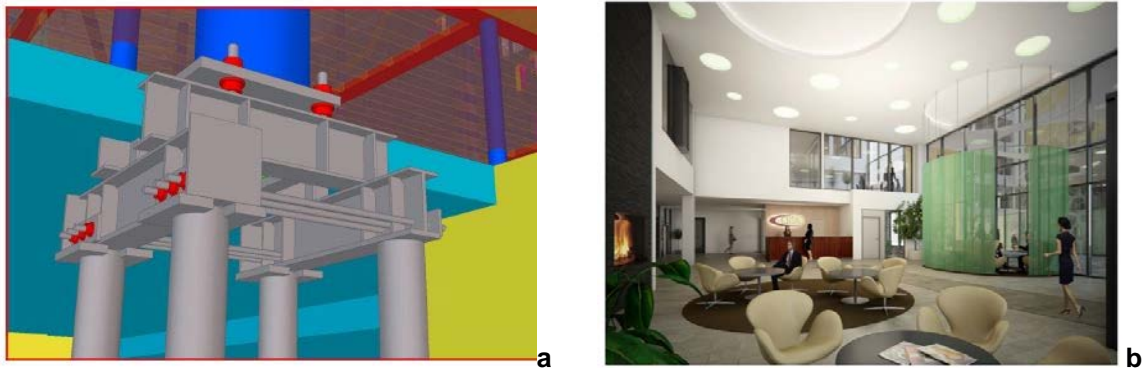

Figure 3.20. (a) Structural details (COBIM, 2012, Series 8, p. 13) and (b) Photo-realistic illustration (COBIM, 2012, Series 8, p. 6).

Support for decisions: BIM can be adopted to study different alternatives (Figure 3.21) by comparing several parameters such as functionality, scopes and costs. For example it can be useful as a support for investment decisions (COBIM, 2012, Series 1, p. 5).



Figure 3.21. Evaluation of design alternatives (Eastman, Teicholz, Sacks and Liston, 2011, p. 158).

Quality Assurance: the check of the project is one of the most powerful utilisation of BIM, because it allows discovering and solving problems in the design phase instead of during the construction (Figure 3.22). Thanks to model checking tools, it is also possible to validate the building with a rule-based validation programme based on rules which have been specified in accordance with BIM requirements (COBIM, 2012, Series 6). This approach is useful for the client, who can control if their requirements have been respected but also for the Building Supervision staff to carry on code reviews such as fire safety (Azhar, Hein and Sketo, 2008; Dimyadi and Amor, 2013) and accessibility (Bellomo, 2012).

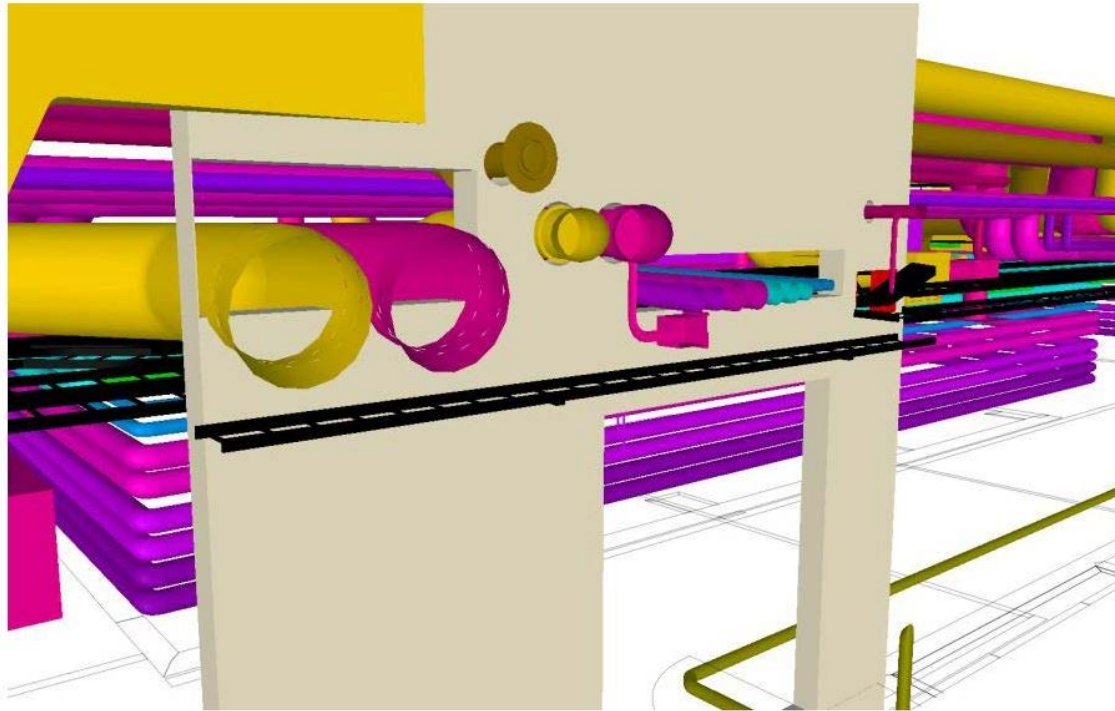
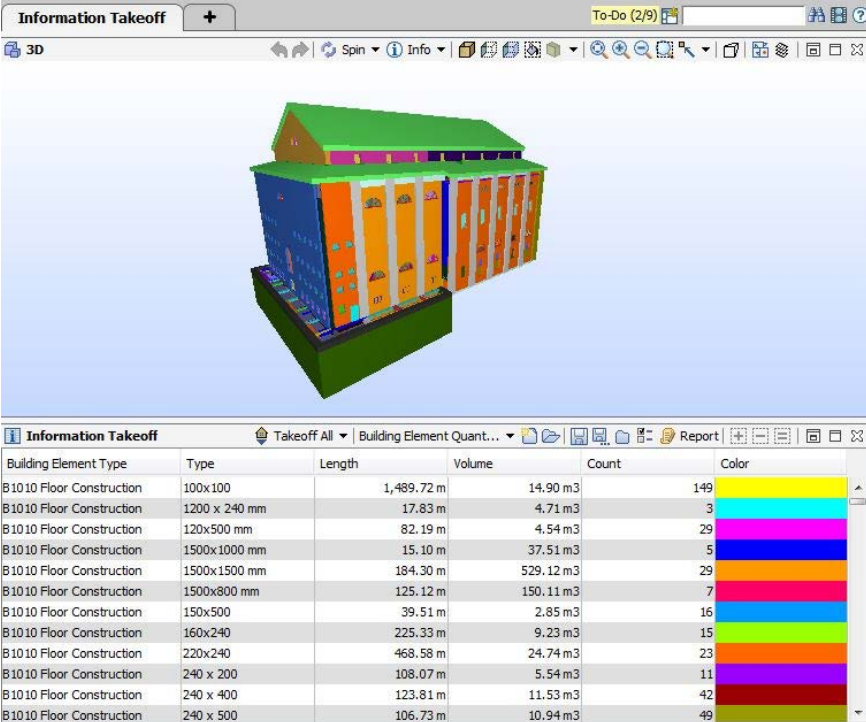

Figure 3.22. Clash detection between MEP and structural models (COBIM, 2012, Series 6, p. 11).

Quantity Take-off (QTO): BIM can be useful to extract quantities (Figure 3.23) during the bidding phase and for purchases during the construction phase (COBIM, 2012, Series 7).



Building Element Type	Type	Length	Volume	Count	Color
B1010 Floor Construction	100x100	1,489.72 m	14.90 m ³	149	Yellow
B1010 Floor Construction	1200 x 240 mm	17.83 m	4.71 m ³	3	Cyan
B1010 Floor Construction	120x500 mm	82.19 m	4.54 m ³	29	Magenta
B1010 Floor Construction	1500x1000 mm	15.10 m	37.51 m ³	5	Blue
B1010 Floor Construction	1500x1500 mm	184.30 m	529.12 m ³	29	Orange
B1010 Floor Construction	1500x800 mm	125.12 m	150.11 m ³	7	Red
B1010 Floor Construction	150x500	39.51 m	2.85 m ³	16	Cyan
B1010 Floor Construction	160x240	225.33 m	9.23 m ³	15	Green
B1010 Floor Construction	220x240	468.58 m	24.74 m ³	23	Orange
B1010 Floor Construction	240 x 200	108.07 m	5.54 m ³	11	Purple
B1010 Floor Construction	240 x 400	123.81 m	11.53 m ³	42	Red
B1010 Floor Construction	240 x 500	106.73 m	10.94 m ³	49	Green

Figure 3.23. Example of Quantity Takeoff tool.

Planning: it is possible to link the quantities to the schedule and generate 4D simulations (Figure 3.24) (Liu and Hsieh, 2011; Furneaux and Kivvits, 2008, p. 9; Barker, 2011).

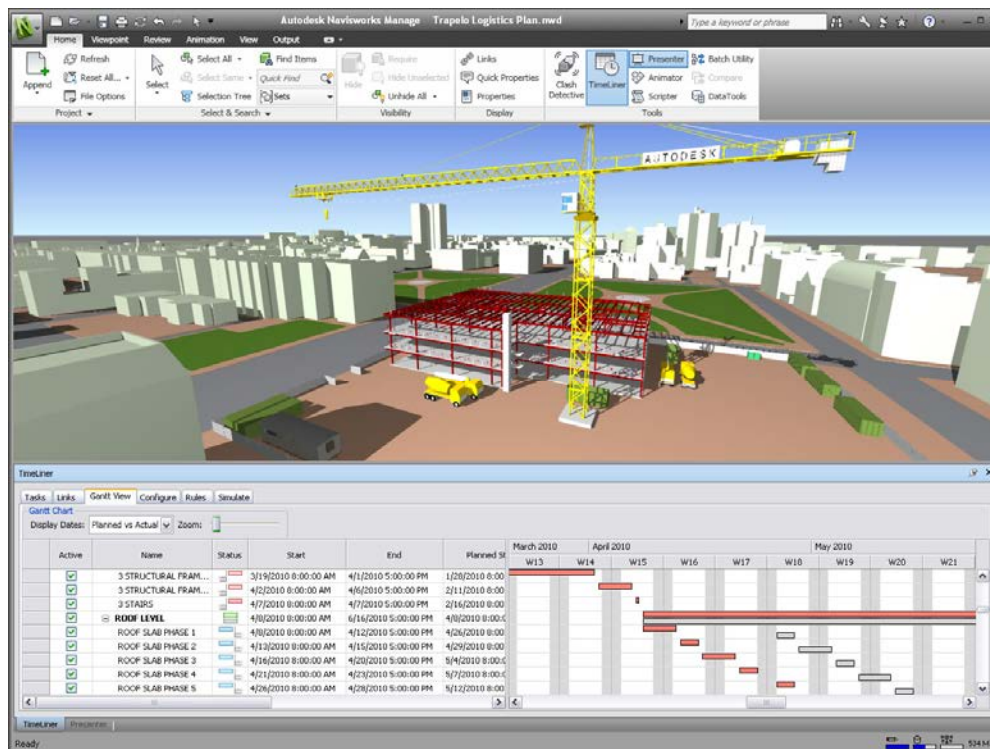

Figure 3.24. 4D simulation. Available at http://www.mrasbuilt.com/MAB_BIM_Navis.html (last visit 9 June 2013).

Cost estimating: linking prices to quantities (Figure 3.25), the cost evaluation can be obtained (COBIM, 2012, Series 7). Moreover, 5D models can be generated to study the cost evolution during the overall process (Statsbygg, 2011, p. 64; Liu and Hsieh, 2011).

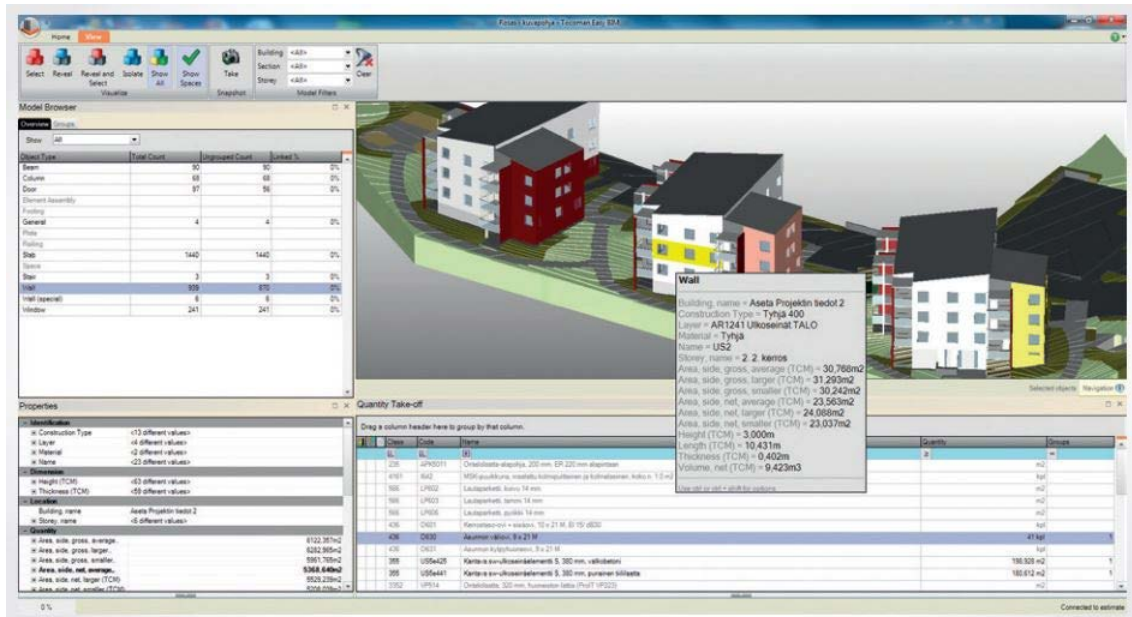

Figure 3.25. Cost estimation using a BIM software programme. Available at http://www.tocoman.fi/sites/default/files/webfm/user/Tocoman_Easy%20BIM_finalKT_screen.pdf (last visit 9 June 2013).

Analyses: BIM can help designers to simulate the lifecycle performance of the building. Several analyses can be carried on e.g. Structural, MEP (Figure 3.26) (COBIM, 2012, Series 9), Energy (COBIM, 2012, Series 10), Acoustical and Lighting analyses (Figure 3.27) (Statsbygg, 2011, p. 64).

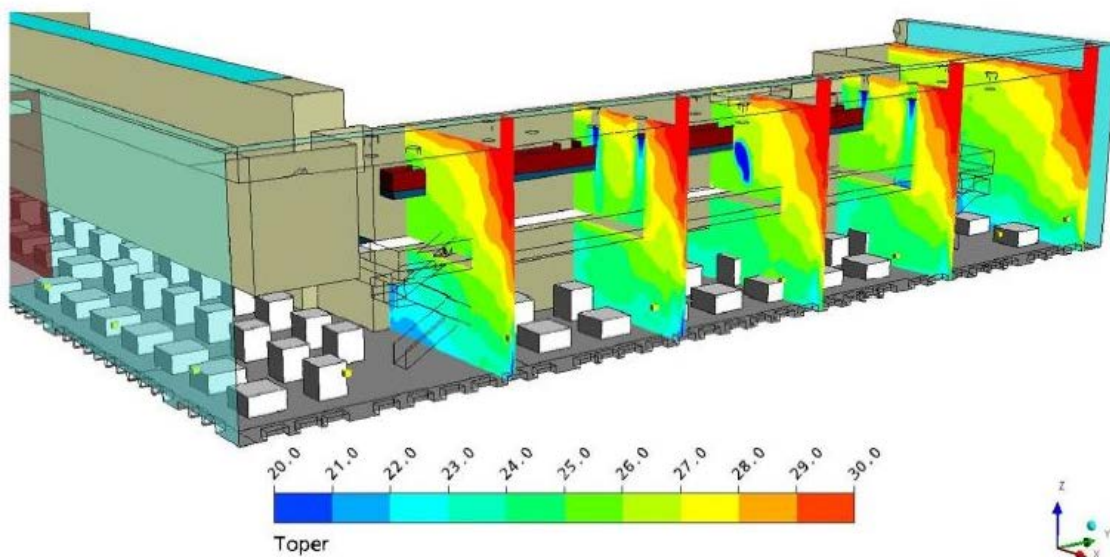

Figure 3.26. MEP analysis (COBIM, 2012, Series 9, p. 7).



Figure 3.27. Lighting analysis (COBIM, 2012, Series 9, p. 14).

Construction: BIM is also adopted for safety planning (Figure 3.28) such as to study the fall prevention and the construction site layout (Figure 3.29), paying attention to the interactions with the surrounding areas. Moreover, 4D simulations are useful for example to control the installation sequences of components, the schedule of production, for constructability reviews and to visualise the construction status (COBIM, 2012, Series 13; Kiviniemi, Sulankivi, Kähkönen, Mäkelä and Merivirta, 2011).



Figure 3.28. Examples of 3D site layouts (Sulankivi, Mäkelä and Kiviniemi, 2009, p. 40).

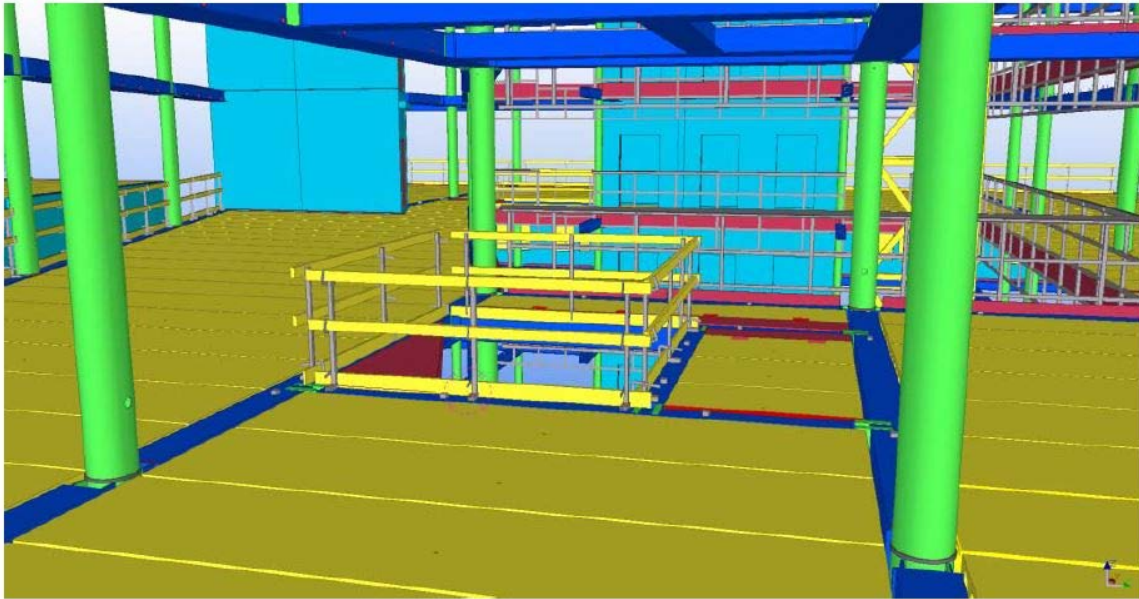

Figure 3.29. Examples of a BIM-based safety railing plan (Sulankivi and Kiviniemi, 2011, p. 14).

Facility Management (FM): BIM can be adopted as a support during the operation and maintenance of the facility such as for renovations and space planning planning (Figure 3.30) (COBIM, 2012, Series 12).



Figure 3.30. Visualisation of system zones (COBIM, 2012, Series 12, p. 10).

3.4 Interoperability

3.4.1 Introduction

This paragraph shows the main data exchange workflows and formats available up until now, paying more attention to BIM-related open standards, such as Industry Foundation Classes (IFC). Also the implementation of open standards within Public procurement is examined.

3.4.2 Data Exchange workflows and formats

Today the degree of collaboration among project participants is not complete and it can increase. Indeed, usually each part produces its files and then it provides them so that the other parties can develop the project. In this way the concept of 'collaboration' is more related to the fulfilment of obligations than to a real dialogue and cooperation. Without a transparent and integrated process, the number of conflicts is very high and it is not possible to find the best solution for a problem because decisions have already been taken by others. This wrong attitude is supported by a fragmented industry actor landscape (Laakso and Kiviniemi, 2012, p. 135) and by tools which do not allow a real interoperability (Várkonyi, 2010), indeed, there is not only one application which covers all the requests of the AEC/FM industry (Venugopal, Eastman, Sacks and Teizer, 2012, p. 412). The main aim of interoperability is giving the possibility to get the right data in the right format at the right time, at the same time, trying to delete the waste on recreating, editing and converting building data during the whole process, where a large quantity of information is created (Eastman, Teicholz, Sacks and Liston, 2011, p. 100). Thereby interoperability between information systems improves efficiency and offers the possibility for savings and financial benefits (Laakso and Kiviniemi, 2012, p. 136).

At the beginning, interoperability was related on file-based exchange formats focused on geometry such as DXF (Drawing eXchange Format) or IGES (Initial Graphic Exchange Specification) (Venugopal, Eastman, Sacks and Teizer, 2012, p. 412). From the 1980s, the development of data models was carried on to support product and object model exchanges among different industries and ISO-STEP international standard was the leader in this effort. Building model exchange is not simple, since models do not represent only geometry and shapes but also objects corresponding to real elements with attributes and properties (Eastman, Teicholz, Sacks and Liston, 2011, pp. 100–101). Eastman, Teicholz, Sacks and Liston (2011, pp. 101–103) define three types of BIM applications (tools, platforms and environments) and show the main problems in exchanges of data between them. Platform-to-tool exchange is the most important and usually it deals with the translation of parts of the platform's native data model for analyses such as structural or energy ones or QTO. Both direct application-to-application exchange and neutral format, such as Industry Foundation Classes (IFC), support this exchange. Normally the process is one-way and only in few cases the tool's results can automatically change data in the platform. Tool-to-tool exchange, instead, is only unidirectional and its adoption is less popular because data availability within the exporting tool is limited. Some examples are geometrical viewer, e.g. Autodesk Design Review, or the translation of the QTO to cost estimation applications. Finally, the most critical exchange is platform-to-platform (e.g. Revit, ArchiCAD and Tekla) because the development of rules to manage the object's integrity is still limited (Figure 3.31).

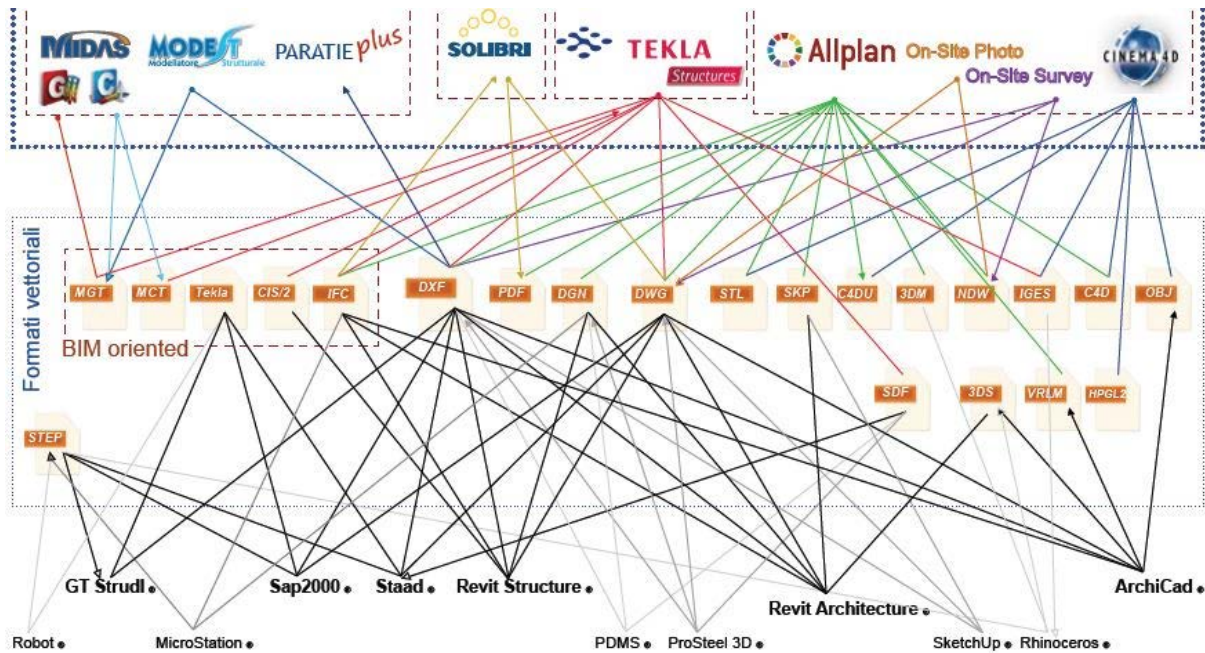

Figure 3.31. Interoperability between different platforms. Available at <http://www.harpaceas.it/sito/simple.nsf/PagOK/Pilloledi-BIM> (last visit 3 June 2013). In Italian.

This is one of the restraints in BIM adoption because workflows are almost correct meanwhile people are using software from the same or compatible vendors, but errors and loss of data increase when exchanges within different software are taking place.

Therefore, the improvement of open standard remains one of the main issues related to BIM (Laakso and Kiviniemi, 2012, p. 135), because it requires interdisciplinary collaboration strategies to overcome the actual defects of the process (Jardim-Goncalves and Grilo, 2010b), thereby it cannot express all its potentialities if there are still multiple proprietary formats not compatible to each other (Venugopal, Eastman, Sacks and Teizer, 2012, pp. 411–412). Moreover, Eastman, Teicholz, Sacks and Liston (2011, p. 103) underline the importance of the modification or extension of the model information for different users. One example is the possibility for a structural designer to obtain the useful information needed for structural analysis directly from an architectural model. Currently there are several models for several purposes, because the translation of the information to fit different goals is not possible. Thereby each discipline elaborates its own model with regular synchronisation of the changes with the other models, using a common 'reference model' (Várkonyi, 2010). However, the automatic updating of data when changes are made to one model is not always allowed and manual corrections, which facilitate the number of errors, are made.

Usually there are two levels of definition for data exchange within applications; the former is the schema which defines the meaning of the data exchanged. Some examples of schemas are IGES, IFC, CIMsteel Integration Standard version 2 (CIS/2), Standard for the Exchange of Product Model Data (STEP), Building Automation and Control networks (BACnet), Automating Equipment Information Exchange (AEX), AECXML and City Geography Markup Language (cityGML). The latter, instead, is called schema language and it is the way in which information is formatted such as

SQL (Structured Query Language), EXPRESS and XML (eXtensible Markup Language). At the beginning, schema and schema language were defined as a unique entity (such as IGRES and DXF), but from the 1980s a distinction was adopted. Figure 3.32 shows the relations between schema and schema language.

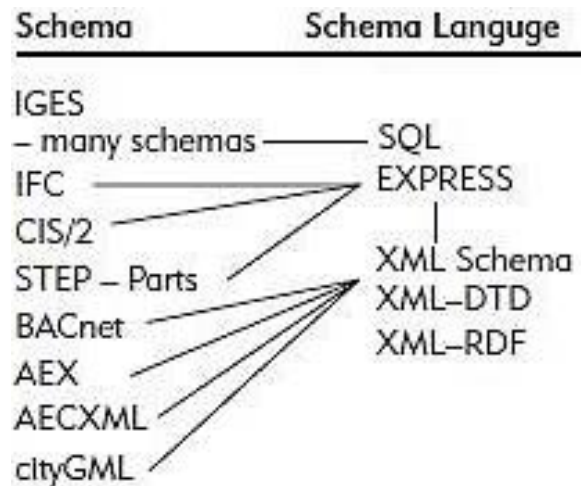

Figure 3.32. Schema and schema language (Eastman, Teicholz, Sacks and Liston, 2011, p. 106).

3.4.3 IFC and Open standards

The adoption of open standard in the AEC industry is very important because participants are not obligated to employ specific property applications. Moreover, interoperability is advantaged open standards, since each software application does not have to develop direct translators back and forth for all other software which seeks to communicate with. Open interoperability standard, instead, allows each software company to develop only two translators for exporting from and importing to its application (Eastman, Teicholz, Sacks and Liston, 2011, p. 105; Laakso and Kiviniemi, 2012, p. 137; Venugopal, Eastman, Sacks and Teizer, 2012, p. 411) (Figure 3.33). However, today the main software companies do not have only one IFC-translator but they have developed specific IFC translators to communicate with other software.

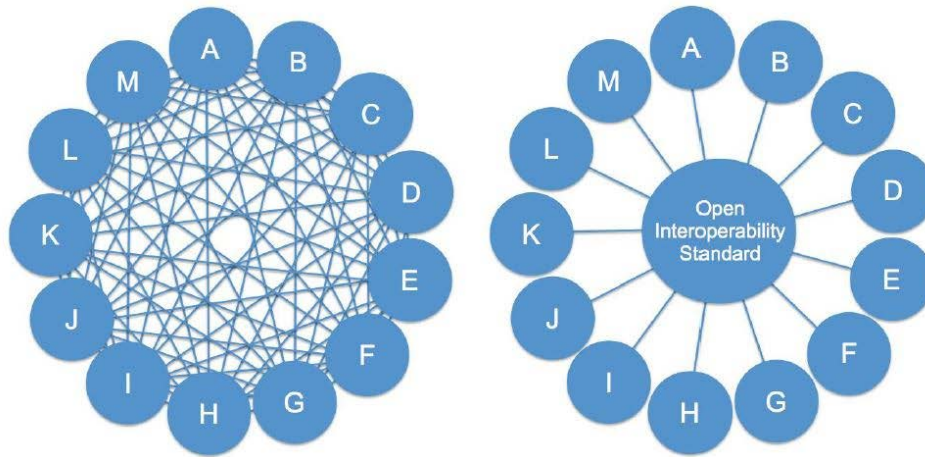

Figure 3.33. Two conceptual scenarios of interoperability: direct translators vs. an open interoperability standard (Bloor and Owen, 1995, p. 18; Laakso and Kiviniemi, 2012, p. 137).

In 1994 a consortium of twelve US-based companies joined together for developing interoperability of BIM data between software applications (Laakso and Kiviniemi, 2012, p. 142). At the beginning, the consortium was defined as Industry Alliance for Interoperability, then it changed its name in International Alliance for Interoperability (IAI) and finally, in 2005 it was renamed buildingSMART (Eastman, Teicholz, Sacks and Liston, 2011, p. 113). It is an international alliance of construction industry representatives and it develops the Industry Foundation Classes (IFC) protocol which is one of the most popular interoperability standards for the construction sector (Várkonyi, 2010). Indeed, IFC is an open and neutral data format and it is written using the EXPRESS schema language. In addition to the .ifc data file, there is also ifcXML, which utilises XML document structure and it is usually 300–400% larger than an .ifc one. Finally, an IFC data file, using a compression algorithm, is available (.ifcZIP) and it is 60–80% smaller than .ifc and 90–95% than .ifcXML (<http://www.buildingsmart-tech.org> last visit 5 June 2013) (Figure 3.34).



.ifc	IFC data file using the STEP physical file structure according to ISO10303-21. The *.ifc file shall validate according to the IFC-EXPRESS specification. This is the default IFC exchange format.	
.ifcXML	IFC data file using the XML document structure. It can be generated directly by the sending application, or from an IFC data file using the conversion following ISO10303-28, the XML representation of EXPRESS schemas and data. Note: an .ifcXML file is normally 300-400% larger than an .ifc file.	
.ifcZIP	IFC data file using the PKzip 2.04g compression algorithm (compatible with e.g. Windows compressed folders, winzip, zlib, info-zip, etc.). It requires to have a single .ifc or *.ifcXML data file in the main directory of the zip archive. Note: an .ifcZIP files usually compress an .ifc down by 60-80% and an .ifcXML file by 90-95%.	

Figure 3.34. IFC data file formats and icons. Available at <http://www.buildingsmart-tech.org/specifications/ifc-overview/ifc-overview-summary> (last visit 4 June 2013).

The first generations of IFCs, IFC 1.0, were published in 1997 (Laakso and Kiviniemi, 2012, p. 147), nowadays all the major software vendors include 2x3 interfaces (Várkonyi, 2010; Porwal and Hewage, 2013, p. 206) and recently a new version, IFC4, has released (BuildingSMART, 2013a). Laakso and Kiviniemi (2012) describe in a detailed way the main stages of the history of the IFC standardisation process (Figure 3.35), which are not presented in this context.

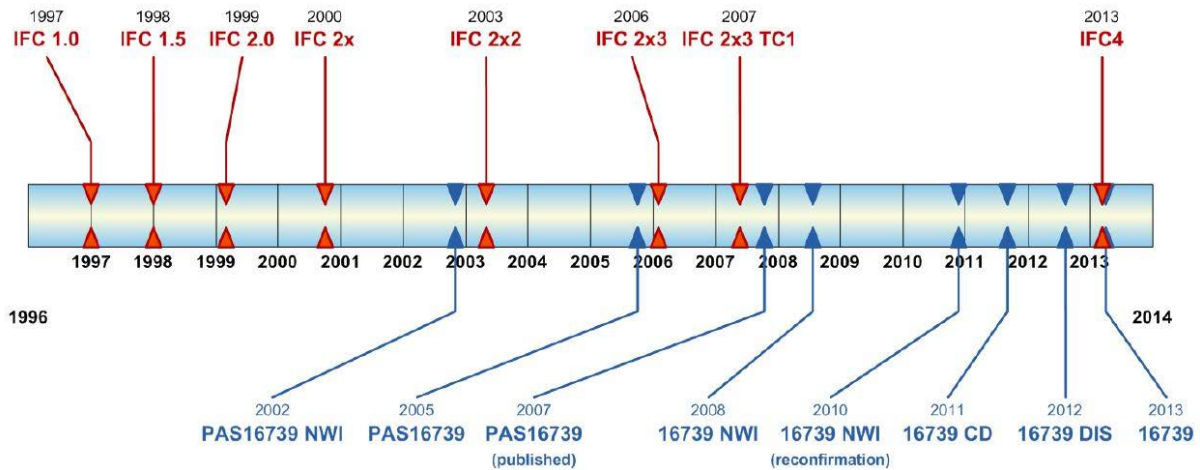

Figure 3.35. History of IFC development (BuildingSMART, 2013a).

IFC contains not only the object forming a building, but also information associated to geometry, relations and properties (Eastman, Teicholz, Sacks and Liston, 2011, p. 118). Most of the BIM software gives the possibility to import IFC and 'Save as' or 'Export' it, in addition to proprietary data formats (Laakso and Kiviniemi, 2012, p. 144; Eastman, Teicholz, Sacks and Liston, 2011, p. 120). However, these options are insufficient for an efficient exchange, because IFC is redundant and it offers several ways to define objects, relations and attributes so IFC implementations require a clear guidance for specific purposes and projects (Venugopal, Eastman, Sacks and Teizer, 2012, pp. 411–413). These specifications are called Model View Definitions (MVDs) and they are essential because they identify what should be expected from an IFC (Eastman, Teicholz, Sacks and Liston, 2011, p. 120; Venugopal, Eastman, Sacks and Teizer, 2012, p. 412), documenting the way data exchanges are applied among different applications (Laakso and Kiviniemi, 2012, p. 150). Indeed, the increment of Interoperability needs a common understanding of the industry process and the data required for and resulting from the execution of these processes; without a clear exchange model view, the IFC can contain errors, omission, contradictions or misrepresentations (Venugopal, Eastman, Sacks and Teizer, 2012, p. 412). MVD are defined as 'a subset of the IFC schema that is needed to satisfy one or many Exchange Requirements of the AEC industry' (<http://www.buildingsmart.org/standards/mvd>) (Figure 3.36).

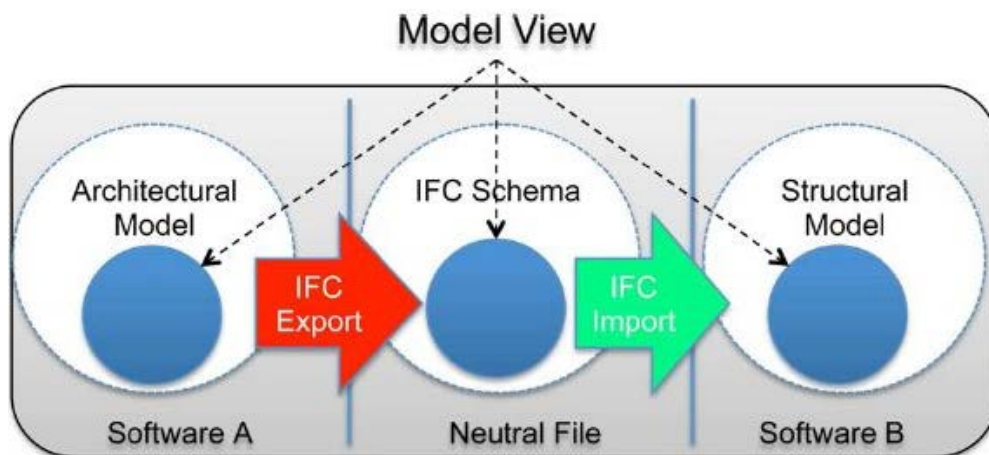

Figure 3.36. Illustration of model views as a subset of the exchange schema (Venugopal, Eastman, Sacks and Teizer, 2012, p. 413).

Thanks to MVD the explorer knows what is required and the receiver knows its content, in this way the gap between the export and import of data is reduced (Eastman, Teicholz, Sacks and Liston, 2011, p. 120).

Another official element of IFC standardisation is the Information Delivery Manuals (IDMs) useful to capture and specify processes and data flows during the lifecycle of a BIM project. Nowadays they are accepted as an ISO standard and they can be utilised to document processes and to define the associated information which has to be exchanged between parties. IDMs require software to be operational because their goal is to ensure that the information is communicated in such a way they can be translated by the software at the receiving side (<http://iug.buildingsmart.org/idms> last visit 5 June 2013). Figure 3.37 describes the relation between MDV and IDM. IFC is the base from which MVDs are established. Software applications are needed to support the exchange and for this reason IDMs give support to enable the workflow taking into account software solutions (Laakso and Kiviniemi, 2012, p. 150).

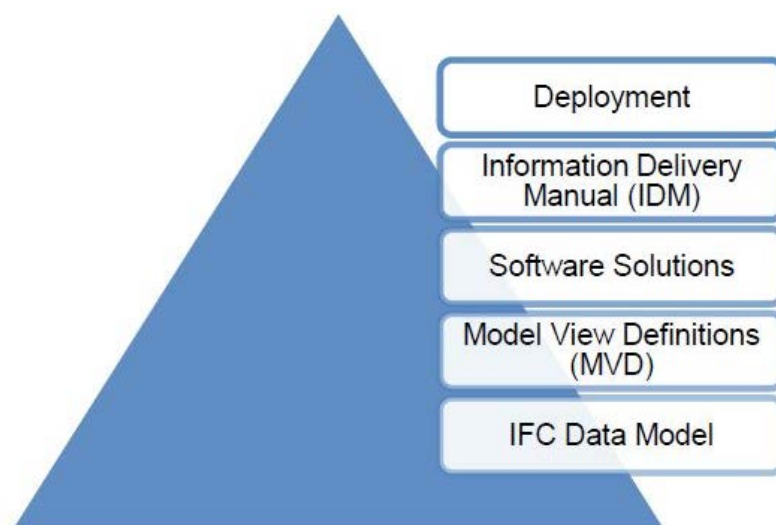

Figure 3.37. Layers of the information exchange framework (Laakso and Kiviniemi, 2012, p. 150).

Another supporting tool for the standardisation is the International Framework for Dictionaries (IFD), recently renamed buildingSMART Data Dictionary (bSDD), which is still under development and testing. It is an ISO standard for terminology libraries or ontologies to connect data from existing databases to IFC (Laakso and Kiviniemi, 2012, pp. 150–151). Usually IFC tags IFD with Global Unique IDs (GUID), which can be referenced to a locally or remote library and produce text strings in any language (Laakso and Kiviniemi, 2012, p. 151). Figure 3.38 shows the three standards of buildingSMART organisation to support a BIM process.

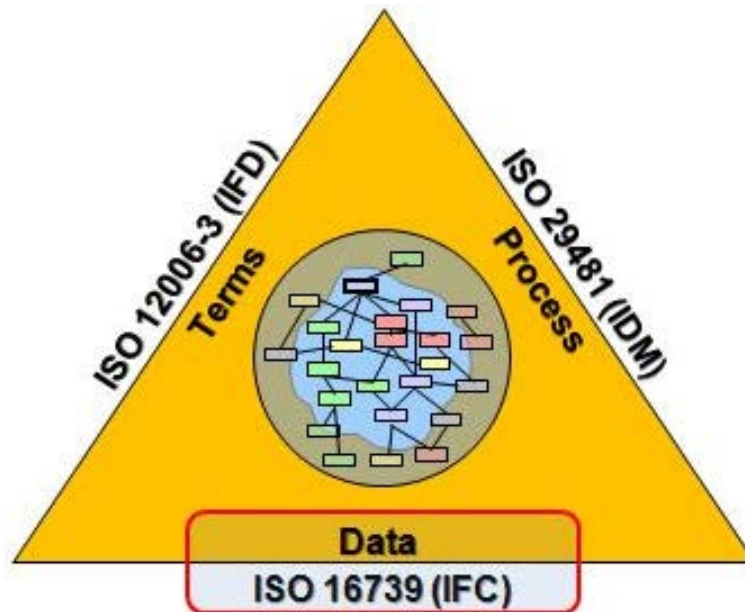

Figure 3.38. buildingSMART standards. Available at <http://www.buildingsmart-tech.org/specifications> (last visit 5 June 2013).

Although this paragraph mostly focused on IFC data model exchange, but also CIS/2 is a public international standard useful for structural steel design, analyses and fabrication in the North America steel sector (Eastman, Teicholz, Sacks and Liston, 2011, pp. 109, 111).

Moreover, two software companies, Tekla and Solibri Inc., developed an XML schema, named BIM Collaboration Format (BCF), which allows only the relevant issues, and not the entire BIM, to be exchanged between software packages. BCF is now implemented in Tekla Structures, Solibri Model Checker and DDS Architecture, improving the workflow and reducing the transfer of large BIM files. Recently buildingSMART received the ownership and the rights of the BCF schema to adopt and keep it as an open standard (BuildingSMART, 2013b).

Another open standard is the National BIM Standard (NBIMS), which is developed and maintained by the BuildingSMART Alliance (Khemplani, 2012c). The BuildingSMART Alliance is an offshoot of the international BuildingSMART organisation of North America, so the correct way of referring to it should be NBIMS-US (Khemplani, 2012c). The BuildingSMART Alliance operates under the aegis of the National Institute of Building Science (NIBS), a leading national organisation in the US focused on buildings. NIBS is a non-profit, non-governmental organisation founded in 1974 and its main mission is to support advances in building sciences and technologies which can im-

prove the performance of buildings in the US reducing waste and conserving energy and resources (Khemlani, 2012c). Like the international BuildingSMART organisation, the US BuildingSMART Alliance promotes open interoperability and the implementation of BIM across the entire lifecycle of a facility (Khemlani, 2012c). The NBIMS is more recent in comparison with IFC and this is the reason why the IFC is much more established and much more well-known than the NBIMS (Khemlani, 2012c). Moreover, IFC pre-dates BIM, instead the NBIMS has been developed specifically around BIM (Khemlani, 2012c). Indeed, it is more focused on the many processes and transactions involved in capturing, organising, distributing and mining building information by all the different players throughout the lifecycle of a building (Khemlani, 2012c). The IFC plays an important role in the current specification of data representation mandated by NBIMS, so it is a crucial subset of the NBIMS (Khemlani, 2012c).

3.4.4 Open BIM and Public Procurement

When BIM adopts open standards, it is called Open BIM. It is very important because it supports a transparent workflow among project members, who are not obliged to adopt specific software. Moreover, a common language allows industry and government to generate projects with transparent commercial engagement, comparable service evaluation and assured data quality. Data can be utilised during the life cycle of the project avoiding overlapping or inconsistent information (<http://www.buildingsmart.org/openbim> last visit 5 June 2013).

One of the peculiarities of the Public sector is the obligation to assure a transparent and neutral approach without facilitating one part instead of another one. For this reason the adoption of Open BIM is encouraged by Public bodies, which favour open standards before proprietary alternatives, because vendor independence, compatibility, prospect of long-term support and commercial neutrality are fundamental (Laakso, 2012a; Porwal and Hewage, 2013, p. 206; Saxon, 2013, p. 80). Indeed, the public sector would like to avoid any proprietary solution that gives the monopoly to one software platform (Eastman, Teicholz, Sacks and Liston, 2011, p. 109). Laakso (2012a) affirms that the IFC effort can be evaluated as 'one of the most ambitious IT standardisation efforts in any industry' because it can generate a substantial productivity growth.

Nowadays IFC is the only public, non-proprietary and well-developed data model for the AEC industry and an international standard, which is being formally adopted by different governments and agencies in various parts of the world (Eastman, Teicholz, Sacks and Liston, 2011, p. 129). For this reason Public sector property owners around the world have been the most influential supporters of IFC-based interoperability in connection to requirements and guidelines (Laakso and Kiviniemi, 2012, p. 152; Porwal and Hewage, 2013, p. 206). Even if IFC standard has a low adoption in comparison with the rest of the construction industry, several public bodies have incentivized its implementation, many including it as a condition for participation in public procurement tenders and projects (Laakso, 2012a). Senate Properties, the Finnish public property owner, has been one of the first requiring IFC in its projects from the 1st October 2007 (<http://www.senaatti.fi/document.asp?siteID=2&docID=517> (last visit 5 June 2013); Porwal and Hewage, 2013, p. 206). Moreover, the Common BIM Requirements (2012) recommend the adoption of IFC in public projects and any non-IFC certificated file formats must be defined by the project manager beforehand (COBIM, 2012, Series 1, p. 7).

Some examples of international projects where IFC was requested in tendering are described in paragraph 4.5.

Moreover, in 2008 Senate Properties has signed the first 'Statement of Intention to Support BIM with Open Standards' with other public owners such as the General Services Administration (GSA) of USA, Statsbygg of Norway, the Danish Enterprise and Construction Authority (DECA) and Rijksgebouwendienst of Netherlands. The Public Statement affirms that government clients are interested in producing 'better built environment' and the way to achieve this goal is sharing information throughout the life cycle of facilities among the several parties involved. For this reason they recognise the importance of the 'development and implementation of open communication standard' and the utility of 'information technologies based on these open standards'. Indeed, the intent of the statement is to support a continue 'development and implementation of Open BIM standards such as the IFCs' through research projects, concrete application of IFC-related BIM solutions in public works, improvement of BIM requirements, open standards directives and development of BIM related standards such as IFD, IDM and MVD. Every new 'Government client organizations or Government ministries or ministry offices that are legally responsible for Government client organizations', accepted by all the existing signatories, can take part to this statement (Public Statement, 2008). In 2011, indeed, also public representatives of Iceland, Mexico and Estonia signed the first amendment to the statement (Public Statement, 2011). It does not substantially differ from the original version, even if the intent is not only to support open BIM standards (such as planning, design and construction component), but also open standards in the 'Smart Buildings' Technologies (SBT) (such as operations components).

3.4.5 Limitations and Possibilities

The interoperability remains one of the most important aspects for the success of the BIM adoption. The development of open standards can promote the BIM usage in Public Work (McAuley, Hore and West, 2012; Laakso, 2012b). Meanwhile Open BIM still needs to be reinforced and enhanced (Saxon, 2013, p. 80) and public owners can play an important role because they can influence the development of the standardisation process either from the demand or the supply-side of the market (Laakso, 2012a). For this reason the work of consortia, such as buildingSMART, should be supported by a larger number of public sector organisations in parallel with national research projects. This process can establish a virtuous circle where public clients acquire more awareness of the potentialities and limits of BIM and at the same time they actively contribute to the BIM growth and assumption.

3.5 BIM implementation in the Public Sector

3.5.1 Introduction

This paragraph describes the current implementation of BIM in the Public Sector of several countries. There are different degrees of development and in some countries it is mandatory and BIM guidelines are available, whereas in others BIM is not promoted. The present situation of Singapore, USA, Finland, UK, Norway, Denmark, Netherlands, South Korea, Hong Kong, Australia, New Zealand, Iceland, Estonia, Sweden, Germany,

China, Ireland, Taiwan and Italy is presented. Moreover, the limitations and possibilities of BIM development in public contexts are discussed and a paragraph is dedicated to the relations between e-Procurement and BIM.

3.5.2 Degree of diffusion in various countries

Singapore

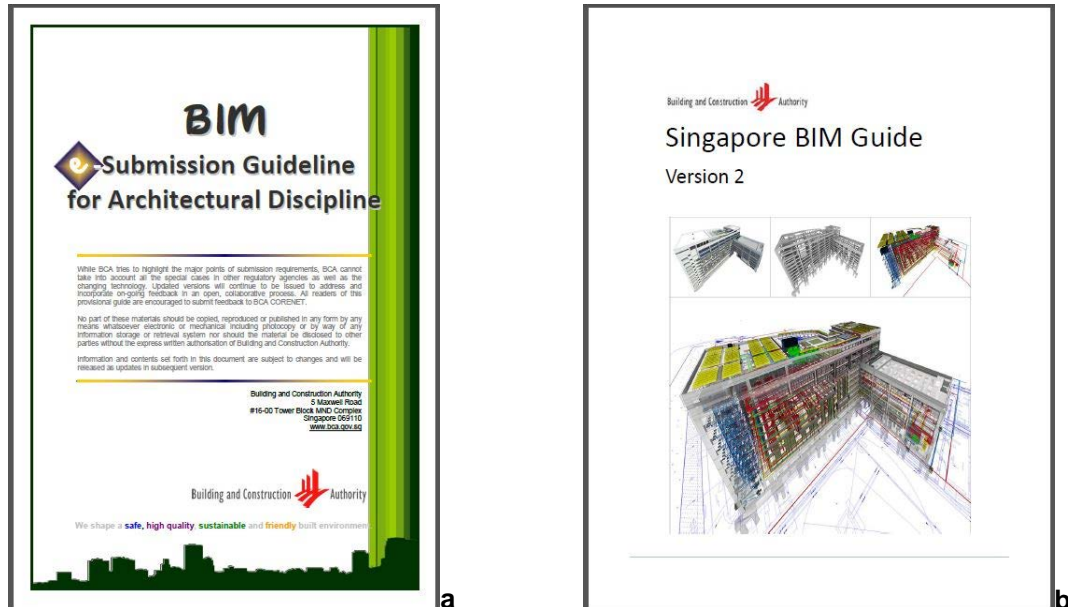

Figure 3.39. (a) BIM e-Submission Guideline for Architectural Discipline. Available at [http://www.corenet.gov.sg/integrated_submission/bim/BIM/BIM_Submission_Guideline\(v3-5\)_Jan10\(Official%20Release\).pdf](http://www.corenet.gov.sg/integrated_submission/bim/BIM/BIM_Submission_Guideline(v3-5)_Jan10(Official%20Release).pdf) (last visit 17 June 2013) and (b) Singapore BIM Guide Version 2 (BCA, 2013).

The Building Construction Authority (BCA) of Singapore was one of the first government organisation developing model-based design, indeed, in the 1990s it was working on a project for the automated code checking, called CORENET (Khemlani, 2012a). Even if that project has not been further developed, the BCA has a roadmap to push the construction industry in the BIM adoption by 2015 (Khemlani, 2012a). Since 2011 the BCA has started to accept Architectural (Figure 3.39a), Structural and MEP BIM e-Submission, and at its website (http://www.corenet.gov.sg/integrated_submission/bim/bime_submission.htm. Last visit 1 July 2013) it is possible to download templates and guidelines compatible with the main BIM software such as Revit, ArchiCAD, Tekla Structure and Bentley AECOsim. Moreover, BCA is developing a library of buildings and design objects, in June 2010 it introduced financing for training, consultancy, software and hardware, it also encourages BIM courses at universities and it organises BIM workshops and seminars (Khemlani, 2012a). In May 2012 the Singapore BIM guide (BCA, 2012) has been published. It outlines the members' roles and the responsibilities in BIM projects at different stages. It helps the development of a BIM Execution Plan and explains the BIM Specifications and the BIM Modelling and Collaboration

Procedures (BCA, 2012). Moreover in August 2013 the new Version 2.0 (BCA, 2013) was published (Figure 3.39b) together with 'BIM Particular Conditions Version 2.0', which will be realised soon in the website.

USA

General Service Administration (GSA), through its Public Buildings Service Office of Chief Architect, established a National 3D-4D-BIM Program in 2003 (Khemlani, 2012a). The National 3D-4D-BIM Program promotes value-added digital visualisation, simulation and optimisation technologies to develop quality and efficiency during the lifecycles of projects. Indeed, 3D, 4D and BIM computer technologies give the possibility to meet customer, design, construction and program requirements in a more effective way. Since 2007 GSA has required spatial program BIMs for all major projects as a minimum requirement for the submission for final concept approvals. Moreover, all GSA projects are encouraged to utilise 3D, 4D and BIM technologies. GSA published Series of Guidelines (available at http://www.gsa.gov/portal/content/105075?utm_source=PBS&utm_medium=print-radio&utm_term=bim&utm_campaign=shortcuts. Last visit 16 June 2013) related to 3D-4D-BIM Overview (Figure 3.40), Spatial Program Validation, 3D Laser Scanning, 4D Phasing, Energy Performance and Operations, Circulation and Security Validation, Building Elements and Facility Management.



Figure 3.40. GSA BIM Guide, Series 1 Overview. Available at http://www.gsa.gov/graphics/pbs/GSA_BIM_Guide_v0_60_Series01_Overview_05_14_07.pdf (last visit 23 June 2013).

In addition to the GSA guidelines, there are other USA BIM Guides published by States and Institutions such as Universities. Indeed, the US Army Corps of Engineers in 2011 has published a 'Building Information Modeling (BIM) Roadmap. Supplement 2 – BIM Implementation Plan for Military Construction Projects, Bentley Platform' (Figure 3.41a) to replace the previous ERDC TR-06-10, 'Building Information Modeling (BIM): A Roadmap for Implementation To Support MILCON Transformation and Civil Works Projects within the U.S. Army Corps of Engineers' published in 2006. This guideline is focused on the software Bentley workflow and BIM project management practices (US Army Corps of Engineers, 2011).

In 2009 the Associated General Contractors of America published the second edition of 'the Contractor's Guide to BIM' (first edition in 2006), which analyses the implication of BIM for contractors, based on experience provided by contractors that have already adopted BIM (Eastman, Teicholz, Sacks and Liston, 2011, p. 301). Also the US Coast Guard has embraced the utilisation of BIM (Succar, 2009, p. 360) and in 2007 the National Institute of Building Science has published the 'National Building Information Modelling Standards. Version 1' to help all participants in reaching more reliable outcomes from commercial agreements (Figure 3.41b). Later Version 2 was published in 2008 and it is a consensus-based standard which includes reference standards, information exchange standards and best practice guidelines to support users in their implementation of open BIM standards-based deliverables. Finally the ballot submission period for Version 3 ended in August 2013 (<http://www.nibs.org/news/127862/NBIMS-US-V3-Ballot-Submission-Period-Now-Open.htm>. Last visit 23 August 2013).

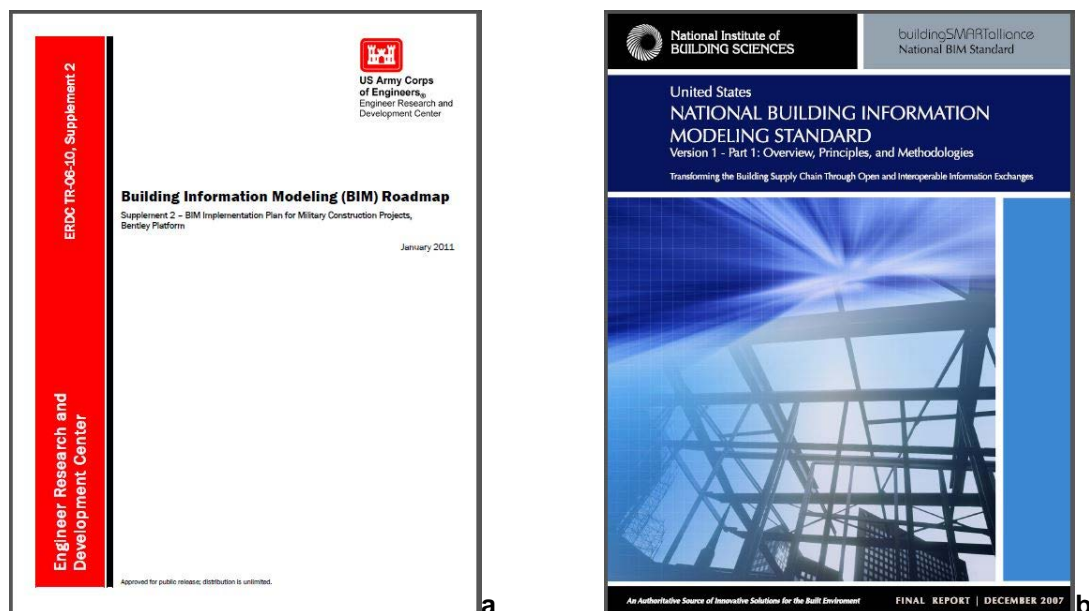

Figure 3.41. (a) Building Information Modeling (BIM) Roadmap (US Army Corps of Engineers, 2011) and (b) National Building Information Modelling Standards (National Institute of Building Science, 2007).

Finland

Finland has a long experience in BIM-based processes and in 2007 Senate Properties, the Finnish unincorporated state-owned enterprise, published its Requirements and guidelines, which have been updated and replaced by the National Common BIM Requirements (COBIM) in 2012. Their aim is to define more precisely what is being modelled and how the modelling is done during all the phases of a construction project to support the parties involved (COBIM, 2012, Series 1, p. 2). At the BuildingSMART Finland website (<http://www.en.buildingsmart.kotisivukone.com/3>. Last visit 23 June 2013) the COBIM are available both in English and in Finnish. They are divided in 13 Series

dealing with 'General BIM Requirements' (Figure 3.42), 'Modeling of the Starting Situation', 'Architectural Design', 'MEP Design', 'Structural Design', 'Quality Assurance', 'Quantity Take-off', 'Use of Models for Visualization', 'Use of Models in MEP Analyses', 'Energy Analysis', 'Management of a BIM Project', 'Use of Models in Facility Management', 'Use of Models in Construction'. In addition, another Series related to the 'Use of Models in Building Supervision' will be published.

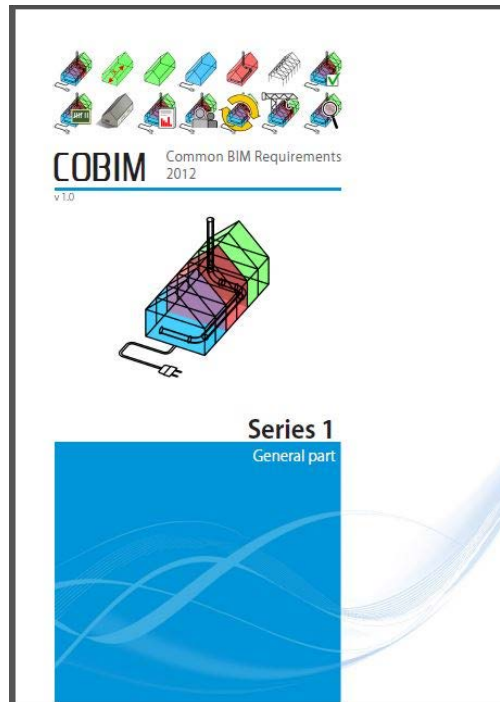

Figure 3.42. COBIM, Series 1 General Part (COBIM, 2012).

Since 2001, Senate Properties has carried on a number of pilot projects to develop and study the use of BIM and since the 1st October 2007 it has decided to adopt BIM and IFC standard in both the construction and the renovation of ordinary projects. The starting situation and the architectural design are mandatory as well as the monitoring of costs. Moreover, the architectural design is useful to study alternatives based on space models and to prepare the tender documents for the contracting stage. During the project planning stage, BIM supports the investment decision, the quantities extracted from the model are adopted to assist the production phase and BIM is also useful for energy simulations.

Recently the City of Helsinki (The Real Estate Department), HUS (The Hospital District of Helsinki and Uusimaa), Senate Properties and City of Vantaa (The Real Estate Department) have made a sort of BIM project guideline for Clients in co-operation (Tietomallihankkeen tilaajaohje 1.0). This document is based on COBIM guidelines but it is more detailed and practical and it is one of the few examples of an official definition of BIM implementation within Public Procurement. It is a useful support which will help the Client to prepare calls in order to tender and design contracts, and to define targets for the implementation of BIM in a building construction project. It defines in advance the aim of BIM and how to manage both new and renovation BIM-based projects (Tietomallihankkeen tilaajaohje 1.0).

UK

Financial problems have pushed the UK Government to explore new ways of controlling costs. Indeed, in May 2011 the Cabinet Office published its Government Construction Strategy (Figure 3.43a) and for the first time the ‘Government will require fully collaborative 3D BIM (with all project and asset information, documentation and data being electronic) as a minimum by 2016’ (Cabinet Office, 2011, p. 14). UK Government wants to strengthen the public sector’s client capability in BIM implementation so that all central government departments’ projects will be adopting at least Level 2 BIM (see paragraph 3.2) by 2016 (Cabinet Office, 2012, p. 6). Moreover, the Cabinet Office will develop standards enabling all members to work collaboratively because in its opinion the ‘lack of compatible systems, standards and protocols, and the differing requirements of the clients and lead designers, have inhibited widespread adoption of a technology which has the capacity to ensure that all team members are working from the same data’ (Cabinet Office, 2011, p. 13). Indeed, the AEC (UK) BIM Standard Committee released several BIM standards (Figure 3.43b) for BIM software such as Revit, Bentley and ArchiCAD (available at <http://aecuk.wordpress.com/>. Last visit 1 July 2013), to help the AEC UK firms in the transition from CAD to BIM (Khemplani, 2012a).

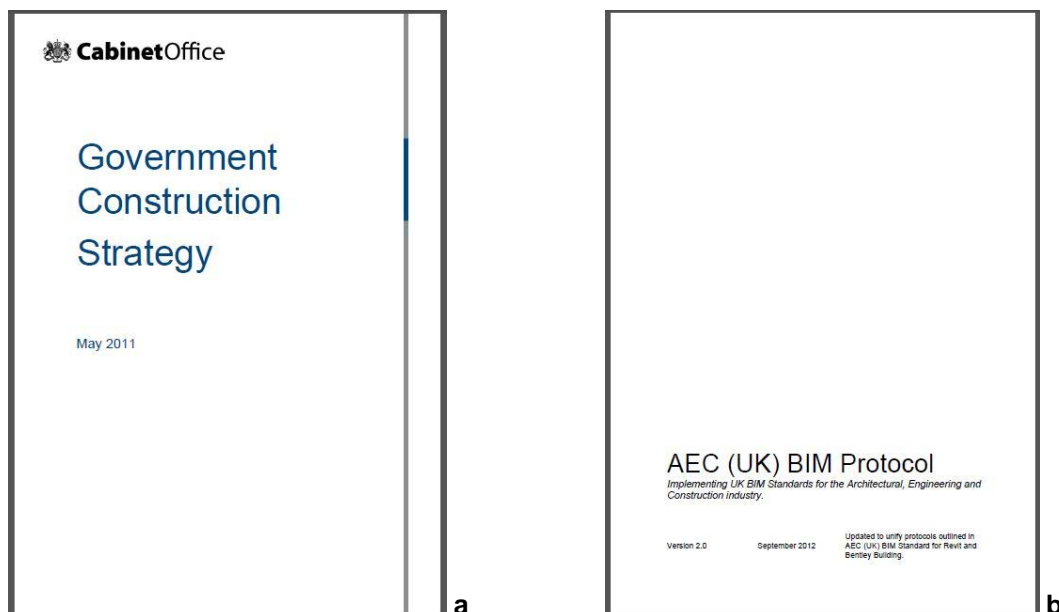

Figure 3.43. (a) Government Construction Strategy (Cabinet Office, 2011) and (b) AEC (UK) BIM Protocol. Available at <http://aecuk.files.wordpress.com/2012/09/aecukbimprotocol-v2-0.pdf> (last visit 17 June 2013).

The aim of the UK strategy is to promote the public sector as a better client, ‘more informed and better co-ordinated’ and to modernise the current business models and the industry practise (Cabinet Office, 2011, p. 3). A BIM Task Group was created to support the work of the Government Construction Strategy and it has progressed rapidly in developing practice and in implementing the policy, so that the UK is in a leadership position amongst national governments (Saxon, 2013, p. 8; *Construction Manager*, 2013). Indeed, even if nowadays the USA dominates the global market, the UK is

growing faster and it would like to export its service abroad and to lead the EU construction policy development (Saxon, 2013, p. 9; *Construction Manager*, 2012a, p. 19). For BIM the scope of serving the global market will be related to the uptake of the BIM approach among all the stakeholders such as clients, consultants, constructors, product makers and facility managers across the world (Saxon, 2013, p. 19). To facilitate this aim, other countries should recognise UK classification, standards and contract processes (Saxon, 2013, p. 23). Additionally Saxon (2013, p. 11) says that 'there is no doubt that the policy of mandating BIM use for government work will create economic growth. The scale and speed of the effect is not quantifiable as yet but should become so if monitoring is well done'.

Philp (2012) says that intelligent client, early contractor involvement and Soft Landings are the ingredients to fulfil the Government Construction Strategy. The Government Soft Landings (GSL) is part of the BIM Task Group and its aim is to ensure that new buildings will be well handed-over and easy to operate (Saxon, 2013, p. 57). To fulfil this goal, the construction and FM requirements must become part of the brief in order to generate better buildings for the final users (Saxon, 2013, p. 57).

Norway

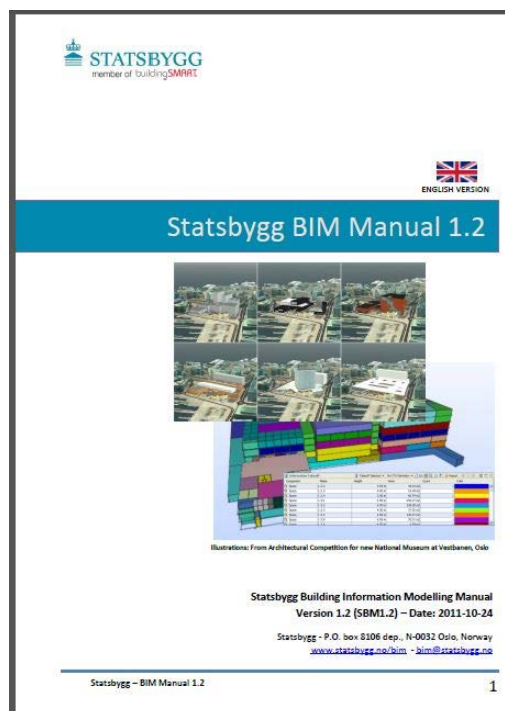

Figure 3.44. Statsbygg Building Information Modelling Manual Version 1.2 (Statsbygg, 2011).

Statsbygg, the Norwegian government agency, adopts BIM for all its new building projects. In 2011 it published a new version of its guidelines, the Statsbygg Building Information Modelling Manual Version 1.2 (SBM1.2) (Figure 3.44) based on previous versions and the past experience. The aim of SBM1.2 is to describe Statsbygg's requirements dealing with the adoption of BIM and IFC format. It contains both generic and discipline specific requirements which can be normative or only informative. It can be

used by design teams, clients, facility managers and domain practitioners involved in the process. Moreover, SBM1.2 may also guide software application providers.

Denmark

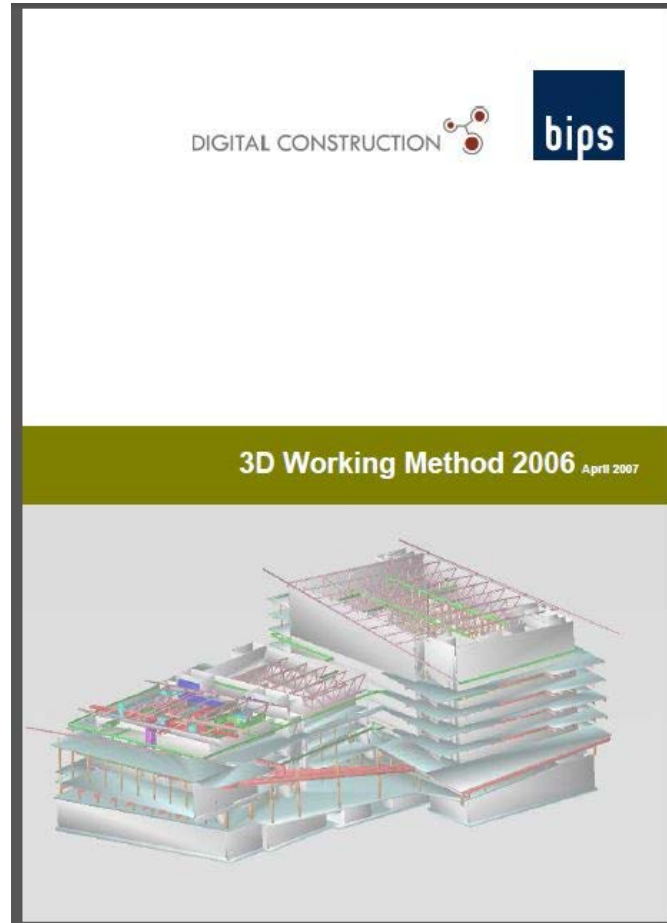

Figure 3.45. 3D Working Method 2006 (BIPS, 2007).

From 2002 to 2007 the Danish Enterprise and Construction Authority has carried on a Digital Construction Initiative to develop common standards and guidelines for digital construction projects (Steffensen, 2012). In 2007 it decided to adopt BIM requirements for governmental projects (Wong, Wong and Nadeem, 2009) and the main requirements are:

- the Danish Building Classification System;
- project web-system for exchange of digital information on building projects;
- 3D-models (BIM) in competitions, design and construction;
- digital bidding and tendering (based on 3D-model);
- hand-over of relevant, digital information at the end of the building process;
- IFC-format for data exchange.

In June 2011 the Danish Parliament decided to extend the mandatory adoption of BIM to all local and regional projects worth over 2.7 million euro, while central government projects have a lower threshold of 677.00 euro (BuildingSMART, 2011b). Moreover, the

no-profit organisation Bips published several standards to support the development of digital constructions:

- The Danish Building Classification System (8 guides and 29 classification table);
- 3D Working Method guideline (Figure 3.45) (BIPS, 2007);
- Logistics & Process guideline;
- ICT-specifications guideline that help the definition of agreements between the actors concerning digital deliveries (Steffensen, 2012).

Netherlands

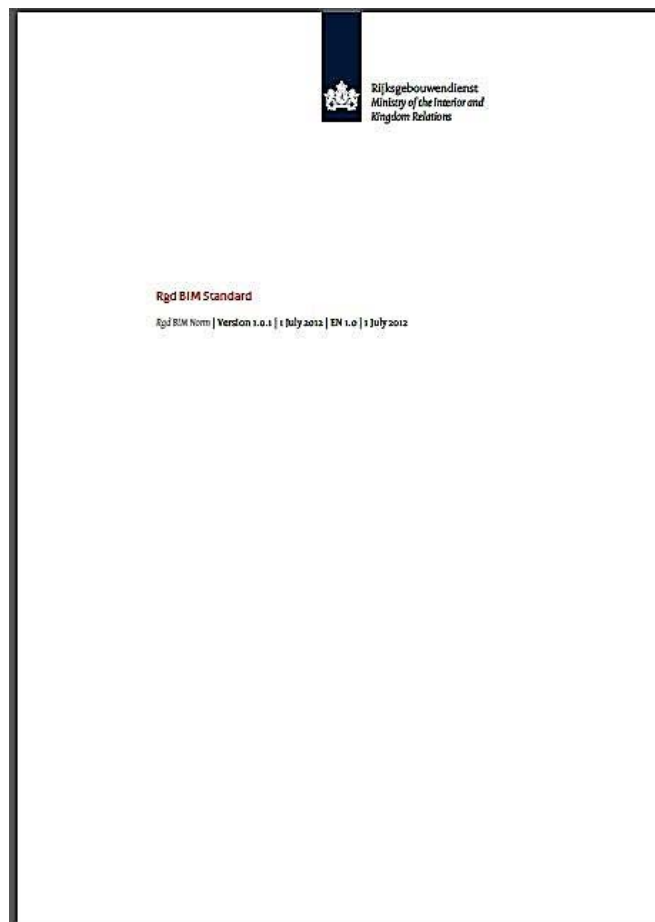

Figure 3.46. Rgd BIM Standard (Rijksgebouwendienst, 2012).

The Rijksgebouwendienst, the Dutch Ministry of the Interior and Kingdom Relations mandates the BIM adoption and in 2012 it published the English version 1.0 of the BIM Standard (Rijksgebouwendienst, 2012) (Figure 3.46). It describes the specifications of BIM extracts and accompanying deliverable files but it does not show neither the instructions step-by-step for achieving a result in compliance with these specifications nor a BIM or CAD manual (Rijksgebouwendienst, 2012, p. 5). In February 2013 the new version 1.1 was published but the English translation is not yet available.

South Korea

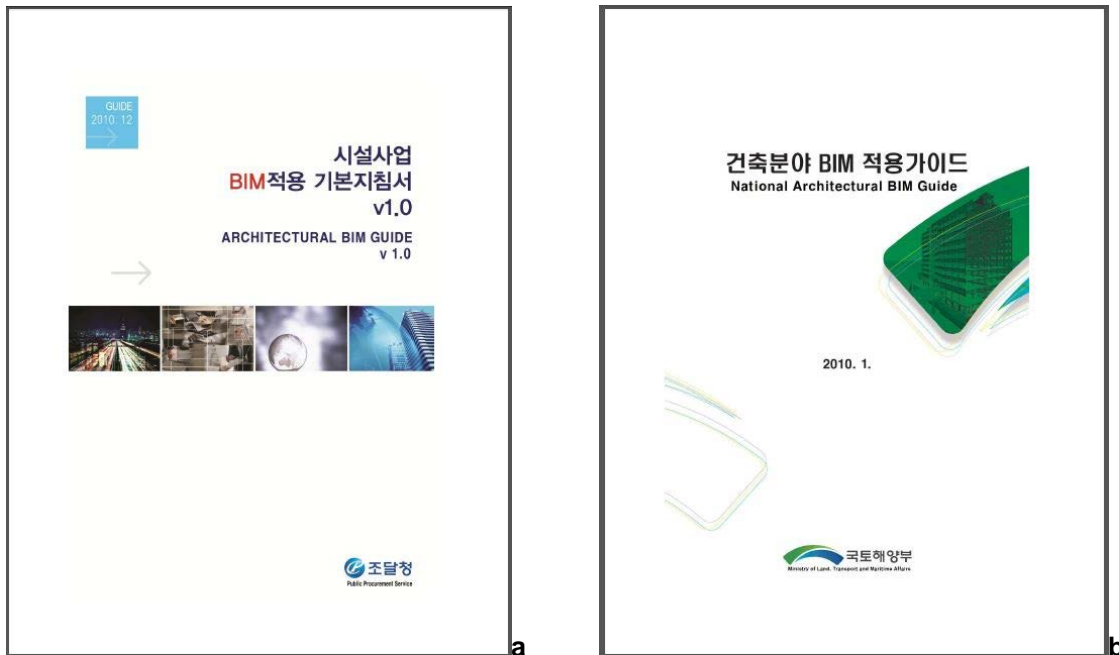

Figure 3.47. (a) Architectural BIM Guide v 1.0 Available at http://www.buildingsmart.or.kr/Document/BIM_Guide_vol1_KoreaPPS_2010_eng.pdf (last visit 17 June 2013) and (b) National Architectural BIM Guide. Available at http://www.buildingsmart.or.kr/Document/BIM_Guide_MLTL_Korea_2010_eng.pdf (last visit 17 June 2013).

South Korea's Public Procurement Service made the adoption of BIM mandatory for all projects over S\$50 million and for all public sector projects by 2016. (Build Smart, 2011, p. 3). Moreover, in 2010 the Public Procurement Service published an 'Architectural BIM Guide' (Figure 3.47a) to reduce the burdens in the industrial market resulting from the new technology adaptation. BIM is adopted on each design stage and for building energy efficiency, energy simulation and basic quantity take-off. Moreover, also the Ministry of Land, Transport and Maritime Affairs distributed the 'National Architectural BIM Guide' (Figure 3.47b) in 2010. Its aim is to invigorate the systematic implementation of BIM in the inner public industrial market and also to set up the specific and practical standards of BIM application for each organisation. At <http://www.buildingsmart.or.kr/> (last visit 17 June 2013) both guidelines are available in English but they contain only the index, while the full text is in Korean.

Hong Kong

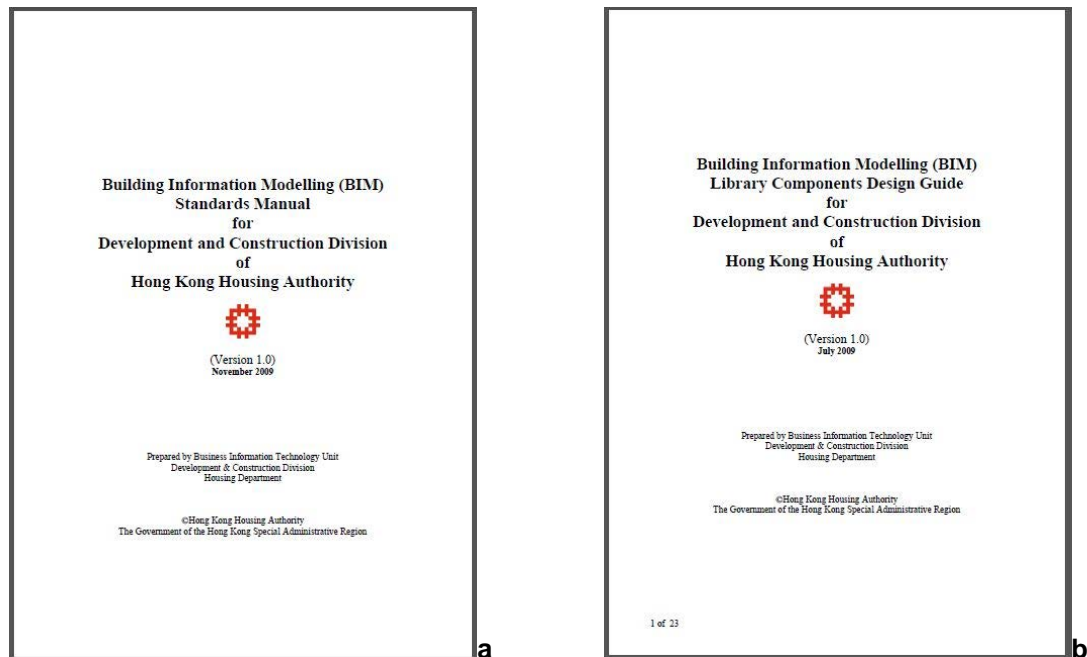

Figure 3.48. (a) BIM Standards Manual for Development and Construction Division of Hong Kong Housing Authority. Available at: <http://www.housingauthority.gov.hk/en/business-partnerships/resources/building-information-modelling/index.html> (last visit 17 June 2013) and (b) BIM Library Components Design Guide for Development and Construction Division of Hong Kong Housing Authority. Available at <http://www.housingauthority.gov.hk/en/business-partnerships/resources/%20building-information-modelling/index.html> (last visit 17 June 2013).

The Hong Kong's Housing Authority has started piloting BIM since 2006 and it will require BIM for all new projects from 2014. It has also developed a set of BIM standards (Figure 3.48a), user guide, library component design guide (Figure 3.48b) and references for effective model creation, management and communication among BIM users (Build Smart, 2011, p. 4), which are available at <http://www.housingauthority.gov.hk/en/business-partnerships/resources/building-information-modelling/index.html> (last visit 18 June 2013).

Australia

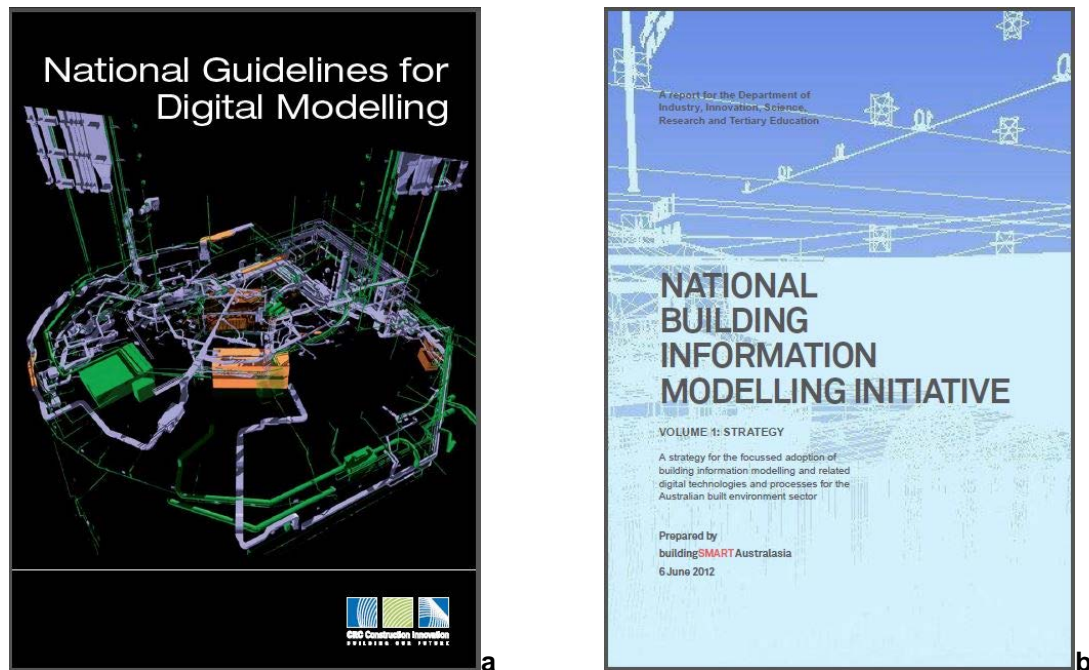

Figure 3.49. (a) National Guidelines for Digital Modelling. 2009. Available at http://www.construction-innovation.info/images/pdfs/BIM_Guidelines_Book_191109_lores.pdf (last visit 17 June 2013) and (b) National Building Information Modelling Initiative Volume 1: Strategy (BuildingSMART Australasia, 2012).

In 2009 the Cooperative Research Centre for Construction Innovation published two guidelines related to National BIM Guidelines (Figure 3.49a) and Case Studies available at <http://www.construction-innovation.info/index6d6d.html?id=1083> (last visit 17 June 2013).

Moreover, in 2012 BuildingSMART Australasia published a National BIM Initiative (Figure 3.49b) (BuildingSMART Australasia, 2012) to drive the construction industry into a new efficient, low carbon era of BIM. It recommends that industry and the Australian Government work together to promote initiatives that will accelerate the adoption of BIM in Australia and ensure the growth of the construction sector. The Key Initiatives recommended include:

- require full 3D collaborative BIM based on open standards for information exchange for all Australian Government building procurements by 1 July 2016;
- encourage the Australian States and Territories through the Council of Australian Governments to require full 3D collaborative BIM based on open standards for information exchange for their building procurements by 1 July 2016;
- development of the National BIM Initiative Implementation Plan, which requires execution project work programs related to Procurement, BIM Guidelines, Education, Product Data and BIM Libraries, Process and Data Exchange, Regulatory Framework and Pilot Projects;

- establish a taskforce with key stakeholder representation to manage a 5-year programme for the delivery of the National BIM Initiative Implementation Plan (BuildingSMART Australasia, 2012, p. 4).

The National BIM Initiative Report contains two volumes: the Strategy and the Implementation Plan. At the BuildingSMART Australasia website (<http://buildingsmart.org.au/the-national-bim-initiative>. Last visit 17 June 2013) only the first volume is available.

The Department of Defence of the Australian Government recognises BIM benefits and it is going to integrate BIM an IPD it its projects. Indeed, it will adopt 3D, 4D and 5D together with new forms of contracts (<http://www.bimmepaus.com.au/libraries/resources/Forum%202013/bimmepaus%20presentation%20-%2023%20jul.pdf>. Last visit 22 August 2013).

New Zealand

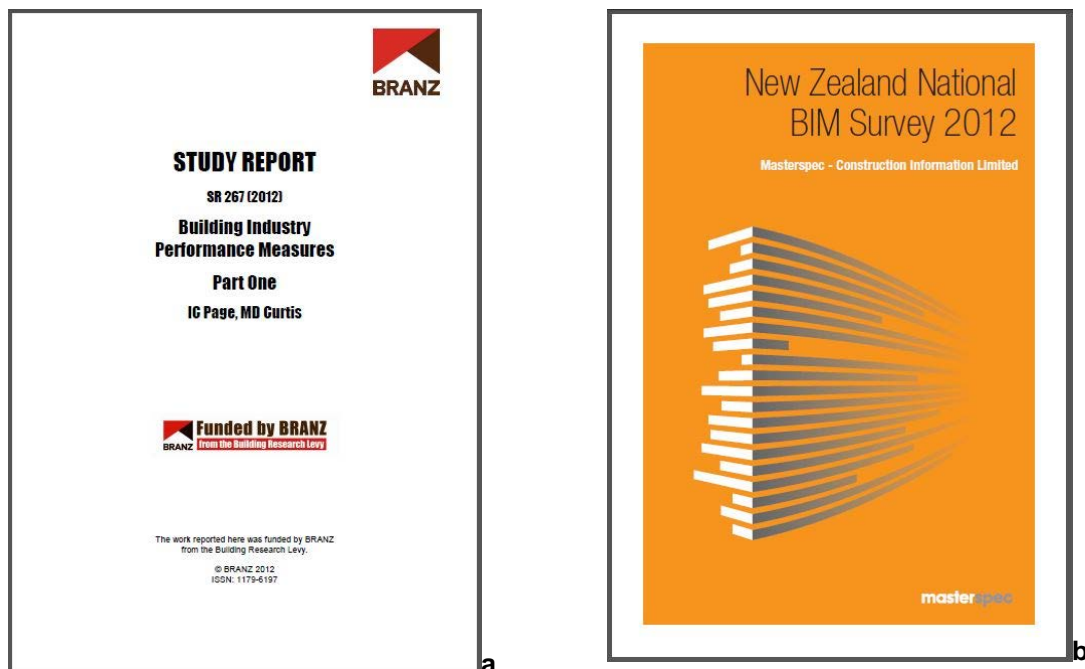

Figure 3.50. (a) Building Industry Performance Measures – Part One (Page and Curtis, 2012) and (b) New Zealand National BIM Survey 2012 (Masterspec, 2012).

In 2012 the government established an initiative called ‘Building and Construction Productivity Partnership’ to improve productivity in the building and construction industries by 20% by the year 2020 (Page and Curtis, 2012, p. 5) (Figure 3.50a). One tool to help achieve this goal is the BIM adoption (Page and Curtis, 2012, p. 5). Moreover, in 2012 Masterspec, the leading specification system in New Zealand’s construction industry, published the ‘New Zealand National BIM Survey 2012’ (Figure 3.50b) to describe the current BIM development.

Iceland

The Icelandic Construction Technology Platform established the project BIM-Iceland and in 2008 a four people group was created to work on the implementation of BIM into the Icelandic construction and design method (Guttormsson, 2011, pp. 11–13). However, the Government Construction Contracting Agency (*Framkvæmdasýsla ríkisins*) does not require BIM yet.

Estonia

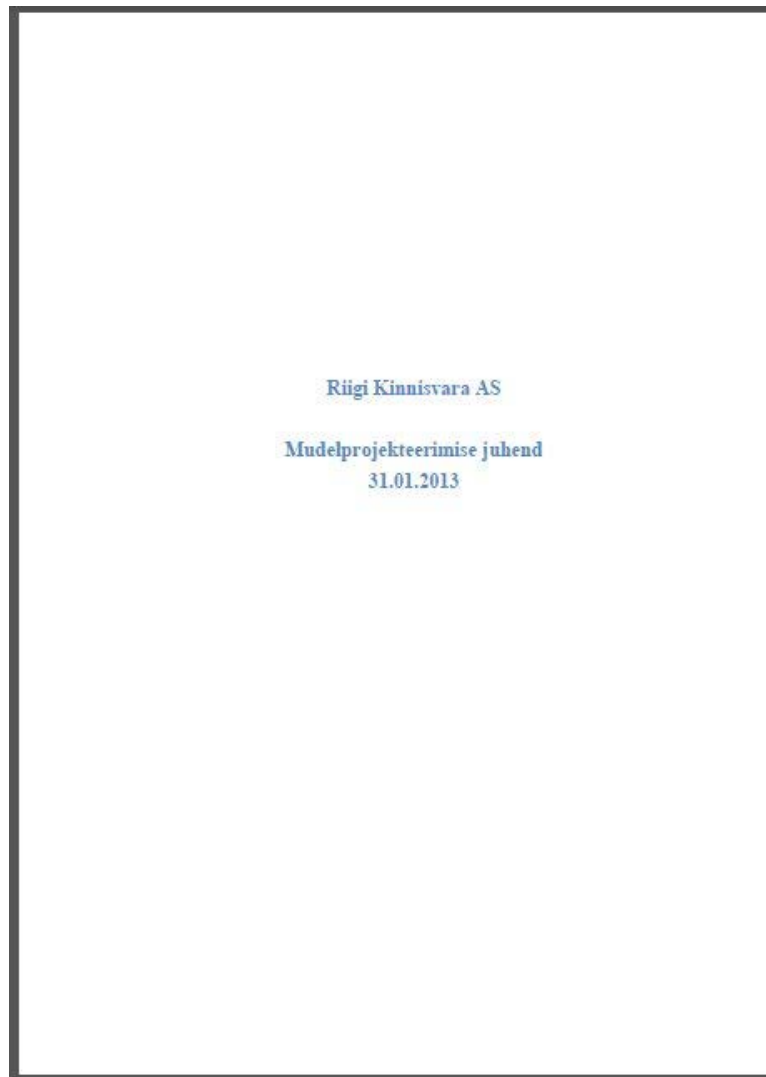

Figure 3.51. Riigi Kinnisvara AS Mudelprojekteerimise juhend 2013. Available at <http://www.rkas.ee/parim-praktika/bim> (last visit 17 June 2013)

BIM is not mandatory in Estonia but the Estonian real estate company Riigi Kinnisvara in 2008–2009 promoted an initiative to implement BIM on design (public) procurements, based on Senate Properties activities (Alt, 2011). At the Riigi Kinnisvara's website (<http://www.rkas.ee/parim-praktika/bim>. Last visit 17 June 2013) a BIM Manual (Figure 3.51), published in 2013, is available only in Estonian.

Sweden



Figure 3.52. BIM – Standardiseringsbehov. Available at http://www.openbim.se/~media/%20Files_OpenBIM/Projekt/130620_BIM_rapport.ashx (last visit 17 July 2013).

Even if BIM is not mandatory in Sweden, five public companies (Akademiska Hus, Fortifikationsverket, Riksdagsförvaltningen, Specialfastigheter Sverige and Statens Fastighetsverk) are collaborating to establish demands and standards regarding BIM adoption in their projects (Lindblad, 2013, p. 61). In June 2013 the Swedish no-profit organisation OpenBIM published a BIM guideline, called ‘BIM – Standardiseringsbehov’ (Figure 3.52) to promote the BIM adoption. The document is available only in Swedish at http://www.openbim.se/~media/Files_OpenBIM/Projekt/130620_BIM_rapport.ashx (last visit 17 July 2013). Moreover, public clients such as the Royal Institute of Technology (KTH) and the Stockholm Country Council have demanded the adoption of BIM in their projects (Lindblad, 2013, pp. 32–48) and the Swedish Transport Administration, Trafikverket, is developing the ‘Stockholm bypass’ implementing BIM (<http://www.ice.org.uk/topics/BIM/Case-studies/Stockholm-bypass>. Last visit 22 August 2013).

Germany

The implementation of BIM in Germany is still at early stages even if software vendors are already offering BIM solutions, some general contractors are adopting it and some pilot projects of public authorities are going on (Both, 2012, pp. 1–2). In 2010 the German Government der Forschungsinitiative Zukunft Bau (Bundesinstitut für Bau-, Stadt- und Raumforschung) organised a Research project called ‘BIM – Potentials and Barriers’ (Both, 2012, pp. 1–2). The aim of this project was to investigate the BIM situation in Germany together with the benefits and barriers related to its development. Repre-

sentatives from public authorities, practice, AEC associations and buildingSMART took part and prepared a questionnaire to analyse the current situation. The results mirror a restricted development of BIM and a general sceptical behaviour toward it (Both, 2012).

China

BIM is not mandatory and it is not mentioned in the five-year plan manifesto, however, China is interested in the energy efficiency of buildings, which is not possible without a model-based representation of the facility. For this reason Khemlani (2012a) says that China is indirectly encouraging the adoption of advanced technologies such as BIM.

Ireland

The Irish Government is not interested in the BIM adoption even if McAuley, Hore and West (2012) explain the importance of a Government move towards the mandatory implementation of BIM to improve the value and the cost of public works.

Taiwan

The government procurements in Taiwan are still paper-based and BIM is not mandatory. Moreover, e-Tendering has been established but the electronic procurement is not completely automatic (Liu and Hsieh, 2011, p. 763). In 2010 the National Science Council constituted an integrated team to study a development strategy for adopting BIM in the AEC industry. Moreover, the Taipei Building Management Agency began to investigate the feasibility of developing a computer-aided checking of design plans. In 2011 the Taipei Mass Rapid Transit Construction Agency publicised the 'Requirements of Modeling the BIM' and chose two projects to test its effectiveness (Liu and Hsieh, 2011, p. 762). Liu and Hsieh (2011) propose a prototype of BIM-based government procurement system, linking BIM to the already existing e-Tendering systems to deliver bidding information and other documentation.

Italy

Italy does not require BIM and the current situation is more outdated in comparison to other countries, although Italy is a member of buildingSMART. In July 2011 the Government funded a research project called InnovANCE (Daniotti, Re Cecconi and Pavan, 2012; Ciribini, 2011a), to create the first national database of technical, scientific and economic information useful to the AEC industry. However, there is not a BIM policy and for this reason in October 2012 Azzone, Buzzetti, Squinzi and Torretta wrote an article to push the Government into adopting BIM tools, interoperability standards and simplifying the normative to improve the current situation of the public works process.

3.5.3 Limitations and Possibilities

The development of BIM in several countries is mostly related to the Government's strategy. Indeed, the public sector's support towards BIM implementation can be a 'driving force'. For this reason it is fundamental an active Government BIM policy with

mandatory BIM requirements, which become a strong pull for research and development (Wong, Wong and Nadeem, 2009; RIBA, 2012, p. 24). An example of this is UK, which is reaching a leading position, after the Government's decision to adopt a BIM strategy (Cabinet Office, 2011). Usually the implementation of a BIM strategy within Public Sector is part of a renovation of the overall system to improve effectiveness (RIBA, 2012). Figure 3.53 graphically illustrates the BIM policy stage of different countries of Europe, Middle East and Africa (EMEA). The bubble size describes the gross domestic product and the image shows the ascent of UK in the last two years.

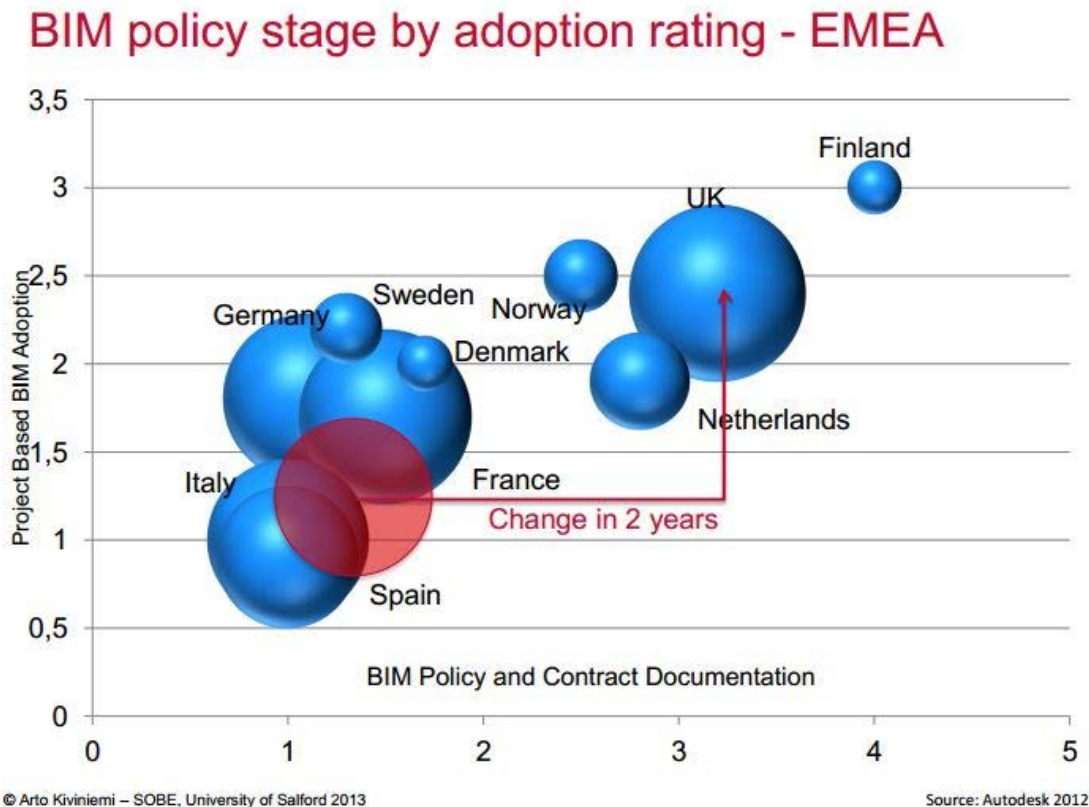

Figure 3.53. BIM policy stage by adopting rating in EMEA (Kiviniemi, 2013).

Moreover, even if the Government's strategy remains the most effective way to implement the BIM diffusion, also advance public clients of institutions can introduce BIM in their requirements. One example is the USA public university Georgia Institute of Technology, which in June 2013 published the 'Architecture and Engineering Design Standards For Building Technology' supporting BIM standards (Board of Regents University System of Georgia, 2013, pp. 12–28). Indeed, all construction projects (new and renovation) from \$5 million and all new construction from \$2.5 million must develop a Building Information Model conformed to AIA (2008) document E202 (Board of Regents University System of Georgia, 2013, p. 12). Moreover, also the New York City School Construction Authority has published a 'Building Information Modeling Guidelines and Standards for Architects and Engineers' (SCA, 2013), which shall be utilised by all the parties involved to 'provide a Project's design in BIM, describes the processes, procedures, and requirements that shall be followed for the preparation and submission of BIM Models (...), as well as to produce, release, and receive data in a con-

sistent format so to maintain an efficient exchange of data between disciplines and the compatibility of each disciplines' Model(s)' (SCA, 2013, p. 1).

Additionally, in 2011 the USA National Aeronautics and Space Administration (NASA) has published a guide 'Building Information Modeling scope of services and requirements for construction contractor in a Design-Bid-Build process. This document describes NASA's requirements for BIM adoption in the construction of its facilities (NASA, 2011, p. 1).

Another example is the Swedish Royal Institute of Technology (KTH), which requires BIM implementation for a new campus at Valhallavägen in Stockholm (Lindblad, 2013, pp. 32–37). The project is in its earliest stage of development and the client wants to utilise it as practical example that can be used in the teaching of students studying engineering at KTH. The facilities are rented from the state company Akademiska Hus, because in Sweden the law prohibits universities to own their facilities (Lindblad, 2013, p. 32). Akademiska Hus has developed a BIM manual to instruct project managers on how BIM should be used in their projects (Lindblad, 2013, p. 35) and it is available only in Swedish at <http://www.akademiskahus.se/downloadpubl.php?IPubliID=165> (last visit 10 July 2013).

In Stockholm there is another important BIM project, the New Karolinska Solna University Hospital, which was started in 2010 and will continue until the autumn of 2017 (Lindblad, 2013, p. 38). The Stockholm County Council, the actor responsible of healthcare in the Stockholm region, made an allocation decision for the Public Private Partnership (PPP) procurement regarding the development, construction, financing and service management of the facility (Lindblad, 2013, p. 38). The PPP agreement was signed between Stockholm County Council and the project company, Swedish Hospital Partners AB, a consortium comprising Innisfree from UK and Skanska from Sweden, which will perform the construction through Design-Build (DB) delivery method (Lindblad, 2013, pp. 38–39). The Stockholm County Council introduced BIM in the contract and many models will be generated to follow the project through its life-cycle (Lindblad, 2013, p. 41). The client did not demand open BIM, such as IFC format, so the interoperability issue has been transferred to the project company (Lindblad, 2013, p. 41). Actually, Skanska has to merge the models and to produce as-built models (Lindblad, 2013, p. 41). Lindblad, (2013, pp. 42–43), after interviewing project participants, affirms that the client has not a clear idea how to develop BIM in the process and this is a weakness, also because BIM has not actually changed the work processes substantially in the design phase, but rather worked as an additional tool to provide good communication between the different design disciplines. However, Coor, the facilities management company which will be responsible of FM until 2040, has a very ambitious goal for BIM adoption (Lindblad, 2013, p. 44). Indeed, it wants to take advantage of BIM for the information management and to improve traceability during the life cycle of the facility (Lindblad, 2013, pp. 44–46). This project is another example a clever public client's will to introduce BIM in the project in order to make progress in FM. Indeed, BIM enables emphasis of the functions that building provides rather than the building itself and a reliable management of the facilities improves services to the client (Lindblad, 2013, pp. 46–47).

Additionally, The Swedish Transport Administration, Trafikverket, is developing the 'Stockholm bypass', a new 21 km motorway to link the northern and southern part of the city, adopting BIM. Indeed, the client wants to implement a Common Data Environment

for all project stakeholders, create intelligent, spatially coordinated, 3D models with meta-data, for all disciplines, establish a continuous review and mark-up process adopting the latest 3D review technologies, extract quantities, cost estimation, scheduling and shop drawings from the BIM and conduct asset management, operations and maintenance thought BIM. This project is very innovative thanks to its new approach which embraces new technologies to geospatially locate documents and models and make data available 24/7 without location limitations. BIM is seen as an important element to meet the client's requirements (<http://www.ice.org.uk/topics/BIM/Case-studies/Stockholm-bypass>. Last visit 22 August 2013).

Furthermore, in Adelaide, the South Australian Government is developing the new Royal Adelaide Hospital under the SA Public Private Partnership (PPP) framework, which is currently under construction and it will be completed by 2016 (<http://www.sahp.com.au/index.php/designaconstruction/bim>. Last visit 4 August 2013). In the call for tender of this public project, BIM was requested, indeed, any suppliers with design input, or provision of any material components, was asked to be aware of the prerequisite of the project to provide their information in a Autodesk Revit format. Moreover, the Registrations of Interest included not only traditional material such as company details, resource capacity, previous experience, but also relevant examples of their Revit Library Content (<http://www.tendersonline.com.au/TenderDetails.aspx?uid=cctol214048>. Last visit 4 August 2013).

The Danish 'Palaces and Properties Agency' of the Ministry of Finance adopted an innovative approach, indeed, it requires the mandatory implementation of 3D models in competitions, mandatory adoption of 3D/BIM for design and call for tender together with electronic tendering tools and electronic hand-over (<http://www.bimbyen.dk/system/files/events/SES.pdf>. Last visit 18 June 2013).

Finally, in UK several public invitations to tender (ITT) requiring BIM have recently been published. Some of them are listed below:

- A new Technical Building for RAL Space in Swindon. 'The Employer wishes to appoint a Principal Contractor (PC) whose team will comprise, but not necessarily be limited to, all necessary design disciplines, planning and building control specialists and all necessary subcontractors, to take the Employer's brief and design and construct a Turnkey technical resource building for RAL Space achieving BIM Level 2 as a minimum and compliance with Government Soft Landing procedures'. Moreover, 'all applicants must be familiar with the latest Government briefings on BIM and Soft Landings'. (http://england.unitedkingdom-tenders.co.uk/43261_Principal_Construction_Contractor_to_include_major_subcontractors_and_design_teams_for_a_new_2013_Swindon. Last visit 15 August 2013).
- Dudley College Town Centre Campus Redevelopment – Priory Road – Centre for Advanced Manufacturing and Engineering Technologies in Dudley. 'It may be the college's intention to procure post contract services as a fully co-ordinated BIM (Building Information Model) with a view to delivering an 'as built' BIM in line with the UK Government deliverables for COBie and/or Level 2 BIM. Suitably qualified contractors may be required to demonstrate their experience and deliverables in this capacity'. (http://england.unitedkingdom-tenders.co.uk/32877_Dudley_College_Town_Centre_Campus_Redevelopment_-_Priory_Road_-_Centre_for_Advanced_2012_Birmingham. Last visit 15 August 2013).

- New City Centre Campus of The University in Birmingham. 'The main contractor shall be presented with a 3D Building Information Model (BIM) at RIBA stage E and will be responsible for its development during the construction phase for issue to the University as part of the completion Operating and Maintenance manuals. The model shall be fully populated for use as part of the maintenance procedure. The contractor and all necessary subcontractors shall fully comply with the requirements of BSRIA Soft Landings Guidelines. The Soft Landings procedure shall be managed directly by the University Estates Team'. (http://england.unitedkingdom-tenders.co.uk/41863_The_University_requires_a_Main_Contractor_to_design_procure_construct_commission_and_2013_Birmingham. Last visit 15 August 2013).
- Containment Level 2 Facility in Swindon. 'There is an expectation that the successful contractor will be able to demonstrate an in depth knowledge, capability and experience of Building Information Modelling (BIM) and be fully conversant with latest Government thinking on sustainable consumption and production, natural resource protection and environmental enhancement, and building sustainable communities'. (http://england.unitedkingdom-tenders.co.uk/41219_Construction_company_for_a_Containment_Level_2_CL2_Facility_2013_Swindon. Last visit 15 August 2013).
- Refurbishment of the first floor and fit out of the third floor at the Ki La Shing Centre to incorporate a Bioinformatics Suite and wet laboratories for the University of Cambridge. One of the required technical capacities is to 'demonstrate information management and design management systems (e.g. BIM) and procedures used'. (http://england.unitedkingdom-tenders.co.uk/41789_Main_Contractor_appointment_for_the_refurbishment_of_the_first_floor_and_fit_out_of_the_third_2013_Cambridge. Last visit 15 August 2013).
- Construction of the Addenbrookes Clinical Research Centre Expansion for the University of Cambridge. One of the required technical capacities is to 'demonstrate information management and design management systems (e.g. BIM) and procedures used' (http://england.unitedkingdom-tenders.co.uk/41788_Main_contractor_appointment_for_the_construction_of_the_Addenbrookes_Clinical_Research_Centre_2013_London. Last visit 15 August 2013).
- Alterations and refurbishment of the Arup Building on the New Museum site in Cambridge. One of the required technical capacities is to 'demonstrate information management and design management systems (e.g. BIM) and procedures used' (http://england.unitedkingdom-tenders.co.uk/22480_Alterations_and_refurbishment_of_the_Arup_Building_on_the_New_Museum_site_2012_Cambridge. Last visit 15 August 2013).
- City centre campus in Birmingham. 'The main contractor shall be presented with a 3D building information model (BIM) at RIBA stage E and will be responsible for its development during the construction phase for issue to the University as part of the completion operating and maintenance manuals. The model shall be fully populated for use as part of the maintenance procedure. The contractor and all necessary subcontractors shall fully comply with the requirements of BSRIA Soft Landings Guidelines. The Soft Landings procedure shall be managed directly by

the University Estates Team' (http://england.unitedkingdom-tenders.co.uk/21796_City_centre_campus_phase_2_main_contractor_2012_Birmingham. Last visit 15 August 2013).

3.5.4 e-Procurement and BIM: SOA4BIM Framework

In literature there are only few examples of integration between BIM and e-Procurement, most of them have been carried out by Grilo and Jardim-Goncalves (2010; 2010a; 2011; 2013). According to these examples (Grilo and Jardim-Goncalves, 2011, p. 114), BIM can be an important approach for e-Procurement, thanks to its ability of 'mapping' traditional unstructured information into structured objects and data, which can be adopted by applications and information systems in an interoperable way. Grilo and Jardim-Goncalves (2011) studied the integration of BIM and computational architectures, namely the Model-Driven Architecture (MDA), the Service-Oriented Architecture (SOA), and Cloud Computing. Indeed, they are developing SOA4BIM Framework, an architecture which converges the former three architectures, and that can develop and rapidly spread e-Procurement in the AEC sector. Indeed, the application of the SOA4BIM Framework in the context of e-Procurement can overcome many technological barriers by re-using much of the standardization and research work done in the BIM and AEC sector, such as adopting IFC standards, together with current technology, like Web services, for implementation (Grilo and Jardim-Goncalves, 2011, p. 114).

The Object Management Group (OMG), an international, open membership, no-profit computer industry standards consortium, has developed a standard called Model Driven Architecture (MDA) to enable a powerful interoperability of enterprise models and software applications (Grilo and Jardim-Goncalves, 2011, p. 110). MDA includes three main layers: Computation-Independent Model (CIM), Platform-Independent Model (PIM) and Platform-Specific Model (PSM). The top layer is the CIM, which represents the most abstract model of the system and describe its domain. This model is based on the business and production processes environment, where a system will be used, abstracting from the technical details of the structure of the implementation system. The middle layer, instead, is the PIM, which determinates the conceptual model based on visual diagrams, use-case diagrams and metadata. Finally, the bottom layer of the MDA is PSM, which targets a specific implementation platform. The implementation method of the MDA is achieved thanks to a transformation which converts the PIM to the PSM. This procedure can be done through automatic code-generation for most of the system's backbone platforms (such as CORBA, NET, J2EE and Web Services).

The Service-Oriented Architecture (SOA), instead, is a set of components that can be adopted, and whose interface descriptions can be published and discovered. Its aim is a 'worldwide mesh of collaborating services that are published and available for invocation on a service bus' (Grilo and Jardim-Goncalves, 2011, p. 110).

The integration of SOA and MDA provides a platform-independent model (PIM) 'describing the business requirements and representing the functionality of their services' (Grilo and Jardim-Goncalves, 2011, p. 110). These independent service models can then be adopted to generate platform-specific models (PSM), depending on the web services executing platform adopting standard such as IFC. The introduction of MDA and SOA in the construction sector gives the possibility to shift from 'a product-based data model

paradigm to a process-based' (Grilo and Jardim-Goncalves, 2011, p. 110), such as service-based, model paradigm, in compliance with the requirements of e-Procurement.

Moreover, the application of SOA on AEC e-Procurement, can connect suppliers' e-Catalogues to contractors, which incorporate catalogued building elements, and where the designer can drag and drop the items from the online catalogues directly to architectural design software, activating the e-Procurement process. However, there is still low interoperability across the e-Procurement activities on the whole life-cycle of the project.

Another emerging computational architecture is Cloud Computing, which 'involves a set of key technologies to address resource sharing based on business requirements' (Grilo and Jardim-Goncalves, 2011, p. 111). It is an evolution over the traditional application service providers, because it is more aligned with the service-oriented environments, than with client-server architectures. Both virtualisation technology and SOA play very important roles in the Cloud Computing development. Indeed, the virtualisation technology handles 'how images of the operating systems, middleware, and applications are pre-created and allocated to the right physical machines or a slice of a server stack' (Grilo and Jardim-Goncalves, 2011, p. 110). On the other hand, SOA is adopted for addressing componentisation, reusability extensibility and flexibility. Together with Cloud Computing paradigm, there are some variations on what service is included, such as Cloud Software as a Service (SaaS), which allows the utilisation of the provider's applications running on a cloud infrastructure. Additionally, Cloud Platforms as a Service (PaaS) is related to software services, running on a cloud infrastructure and finally, Cloud Infrastructure as a Service (IaaS) provides processing, storage, networks and other fundamental computing resources in the cloud system.

Grilo and Jardim-Goncalves, (2011, p. 111) have developed a generic framework, called SOA4BIM, for the AEC sector including the latest architectures like MDA, SOA and Cloud Computing, together with BIM approach (Figure 3.54). The SOA4BIM Framework is based on the development of a Computational-Independent Model (CIM), which will model the design, construction and maintenance building processes and products so that is not constrained by the requirements of the ICT platforms. Works being developed more recently by the building SMART Initiative such as Information Delivery Manual (IDM) can be the base for CIM, indeed, IDM can be adopted as reference Process Maps for the whole construction process life-cycle. Deriving from CIM, the SOA4BIM Framework considers the design of the Platform-Independent Model (PIM), which will be a technology neutral modelling of the several types of information in a construction project, such as 3D model, material composition, project management (costs, time, etc.), contractual arrangements and sustainability. The PIM layer is a standard approach to BIM, where standards like IFCs should be used. For each project a PIM-BIM model is generated including data structures which can be reusable by the agents involved, since it adopts neutral formats. Although the SOA4BIM Framework supports traditional client-server e-Procurement models, it would be better to adopt the Service Trading Model where 'the client (importer) only obtains knowledge of available services at runtime by requesting services and the fulfilling server (exporter) for an appropriate service from the trader at runtime' (Grilo and Jardim-Goncalves, 2011, p. 111). This e-Procurement system architecture is based on the SOA approach. In order to generate a tender document, the client (importer) asks the user questions for the tender; then, the importer asks the trader to give him the name and address of an exporter which can generate a tender document in a specific format. The trader

searches for the registered exporter services and gives back an appropriate exporter to the importer, who opens a communication to the selected exporter. Finally, the exporter sends back the tender document to the importer and/or sends it to selected suppliers. Thus, the SOA4BIM Framework gives the possibility to move beyond current traditional e-Procurement systems and public e-Procurement platforms which are portal-centric client/server models. The integration of SOA with MDA will allow transformations and services which will automatically create Platform-Specific Models (PSM), such as Web services, to each of the agents involved in the process (client, architect, specialist designer). Therefore, each time a service is required by any agent, there will be an automated transformation of the PIM to the specific PSM, through mapping. On the other hand, whenever a construction agent asks the PIM–BIM model to be enriched with new information generated by their applications (e.g. specifications or bill of quantities), new services would be made available, transforming the new PSM requirements into the enriched PIM–BIM model. However, there must be a process to check the conformance in order to validate whether the enriched data conforms to the initial PIM–BIM model, or requires an adaptation to the initial model. SOA4BIM Framework develops these model transformations in a Cloud Computing approach. This approach allows construction agents who have services implying the exchange of data, information or tender documents with other agents, they will trigger Web services (or other SOA-based mechanism) over the cloud, and model transformations and compliance testing will be performed within the cloud, regardless of the physical location of the applications, databases, operating systems, or hardware. In this way each actor will have the required information, without having to know which conversion processes occurred and the enrichment of the PIM–BIM model will dynamically take place without major human intervention.

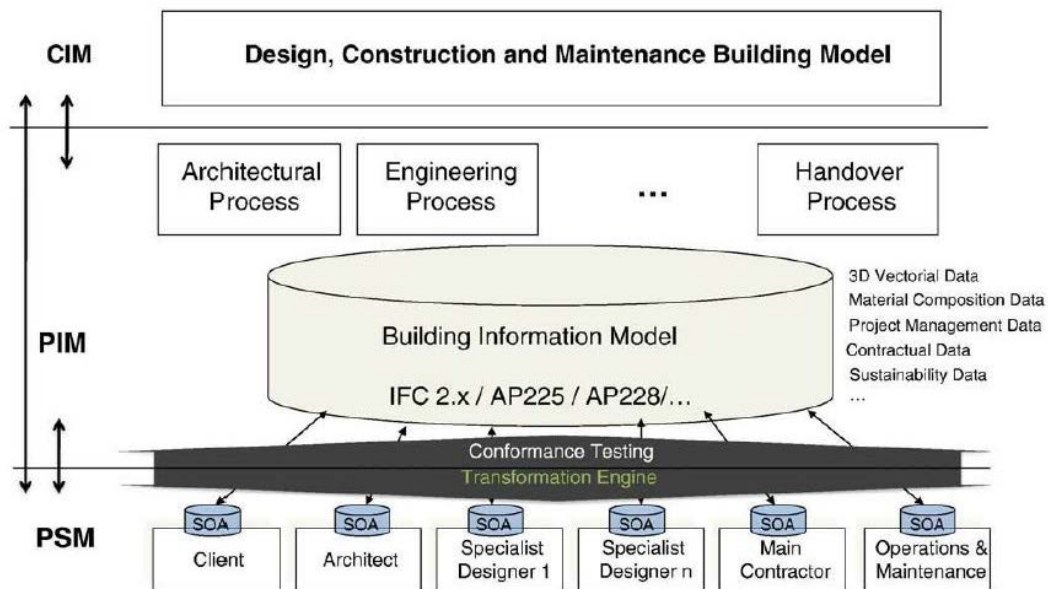

Figure 3.54. Generic SOA4BIM Framework (Grilo and Jardim-Goncalves, 2011, p. 112).

The SOA4BIM Framework is currently being implemented and validated in an industrial Research & Development project, called PLAGÉ, funded by the Portuguese Government, and by the enterprises Vortal, Primavera, and Microfil. The project is concentrated on private and public e-Procurement for the whole life-cycle of a facility. Both commercial

and technical information are modelled in a cloud-based BIM server MDA and SOA architecture, thanks to standards such as IFC, and with an e-Procurement approach adopting SOA and Service Trading Architecture. The aim of the project is to eliminate as much as possible unstructured information from e-Procurement processes. The project also tries to follow current standards of e-Tendering, e-Awarding, and e-Ordering, together with e-signatures. The PLAGÉ Platform is a platform system which combines three different platforms: Microsoft SharePoint 2007, EDM Model Server and Vortal eGOV. Microsoft SharePoint 2007 is adopted as business collaboration platform system and as the front-end, moreover it implements a set of workflow and rule-based procedures for the e-Procurement. The EDM Model Server from Jotne EPM Technology is useful for product and process BIM data management. Vortal eGOV is an e-Procurement platform for the AEC sector for public and private e-Tendering, e-Awarding, and e-Ordering. The three platforms work seamlessly in an integrated way through PSM instances, namely Web services connections. These Web services connections are also useful to connect other AEC specialized software, such as the Primavera Construction ERP Suite or Solibri Model Checker. The PLAGÉ Platform follows the project from the initial stages. The client's team and an architect develop in the PLAGÉ Platform the initial specifications (such as room dimensions, height, relation between spaces and equipment), and the system exports an excel sheet template, configured according to IFC standard, or conversely, uses a BIM-based software application, such as dRofus (for more information see paragraph 4.4.2). Once the technical work is agreed, they upload the early programme and initial concept design BIM model output into PLAGÉ Platform, where a generic BIM-IFC/STEP model is generated on the EDM Model Server through a SOA-based PSM. This product and process model will be a baseline for the next stages of the project. Conformance tests will be carried out to check if the uploaded model conforms to the BIM-IFC/STEP model standard. Later, the architect team will adopt other applications to generate the concept design, such as Onuma Planning System, Autodesk Revit, or similar. Therefore, they will find in the PLAGÉ Platform the initial concept design and early programme BIM-IFC/STEP model, and they will be able to download the file and work off-line. During this stage, designers can include in the working files 'objects' from e-Catalogues. At the end of the feasibility design, the process will be repeated as before, conducting conformance testing over the initial BIM-IFC/STEP model. In this way the initial BIM model will be enriched and updated becoming the new baseline. So far, all of the activities related with the concept design can be achieved without any e-Procurement. However, in the detailed design phase, complex e-Procurement interactions are needed, because several agents will interact and there will be high levels of unstructured procurement information. Therefore, the complexity increases also because competitive tendering is likely to occur, and there will be technical data flows but also commercial and managerial ones. The client will activate the e-Tendering stage through the PLAGÉ Platform workflow. SOA-based PSM, will export the BIM-IFC/STEP technical and contractual data from the EDMmodelServer to the Vortal eGOV to start the e-Tendering process. Besides the architectural designs and specifications, the PLAGÉ Platform also releases the tender documents in compliance with the requirement of the BIM-IFC/STEP standards, and the templates for bidders. In this process complementary information may be added, such as expected dates for execution, maximum price and selection criteria. However, this information is included in the tender documents through structured procedure which also feeds the

original BIM-IFC/STEP model. The Vortal eGOV will configure the e-Tendering and e-Awarding procedures and selection process, and will export tender documents/files to the HVAC competing designers using specific PSM if needed. After working on the technical HVAC designs and commercial data for the bid, the documents will then be exported by the HVAC designers through a similar mechanism to the Vortal eGOV. After the selection process has been conducted, the acceptance of the BIM-IFC/STEP HVAC bid, with technical and commercial data, undergoes the conformance testing, performed on the PLAGE Platform. With the e-Awarding of the selected HVAC designer, contractual arrangements are exchanged, maintaining the BIM-IFC/STEP web services approach. Once the off-line technical work is completed by the HVAC designer, the BIM-IFC/STEP HVAC detailed design is exported to the PLAGE Platform, where, if it is in compliance with the initial model, and is accepted, will enrich the BIM model. Although structured information are preferred in the e-Procurement process, the platform also supports some complementary unstructured information in the bid document. Therefore, the BIM-IFC/STEP HVAC detailed design and the filled-in bid template may contain additional information in the form of attached files (e.g. pdf, JPEG formats) or possibly Web links. However, each element of unstructured information must be linked to an object within the Building Information Model. During the detailed design phase, clash-detection sub-processes are carried out (Figure 3.55), a Web-service will be activated to each participant for importing the BIM-IFC/STEP full detailed design, and another SOA-based service is triggered to perform a BIM-IFC/STEP clash-detection process on an off-line mode.

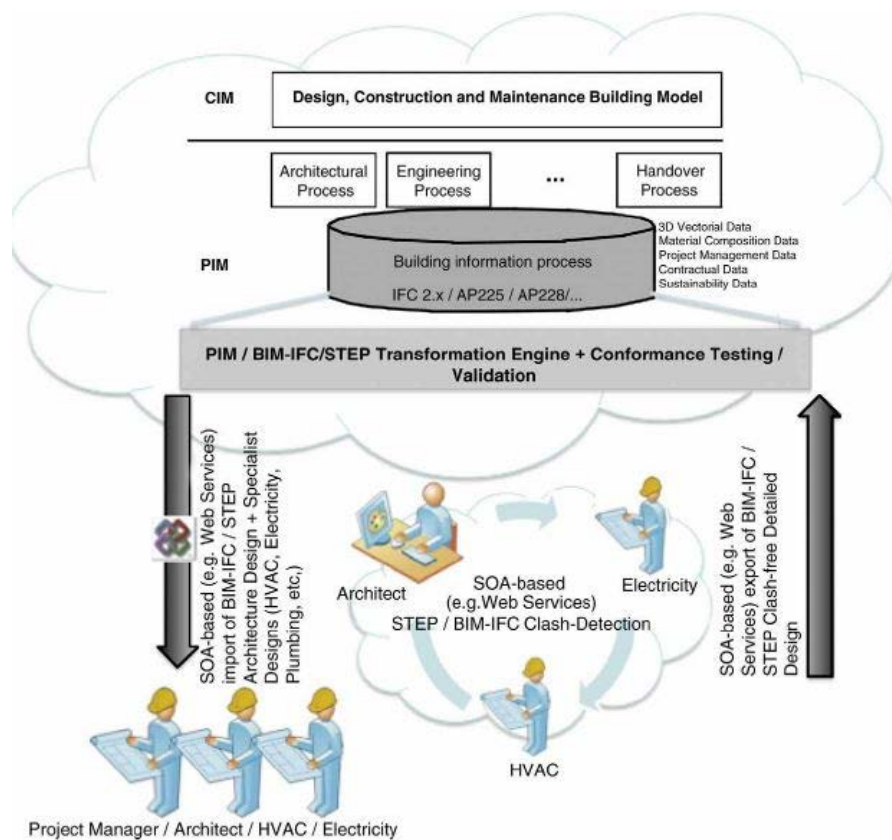

Figure 3.55. Cloud Platform of the BIM-IF/STEP for Clash Detection processes (Jardim-Goncalves and Grilo, 2010, p. 396).

Once the sub-process is completed, the Web services will export the final BIM-IFC clash-free detailed design, which will have to be validated once again through the conformance testing. Even if PLAGE Platform architecture has provided successful results for the design phase of building and engineering projects, there are still many challenges. Thus, it is not possible to export aggregate or individual construction objects, and designers may reuse the data in order to make their own designs and calculations, but current companies' databases are not ready for cost estimating and activity planning for 'building elements'. Indeed, quantities for tendering are easy to obtain directly from the BIM, but it is not simple to organize the elements to be tendered and the existing models do not reflect this need. Thus, the costing process based on BIM elements is very difficult because their applications are not oriented to those formats.

In order to successfully implement BIM in e-Procurement procedure, it should incorporate a BIM platform to manage the process. Nowadays the market offers only few examples BIM Platforms and the most developed are Aconex, 4Projects, Asite and Conject. Aconex is an online collaboration platform for construction and engineering projects which has incorporated BIM (<http://www.aconex.com/bim>. Last visit 9 August 2013). Indeed, it allows a secure storage and easy distribution of large files in order to drive project-wide collaboration on models, it promotes the automation of BIM processes to speed up decisions and provide control and visibility and finally it supports the revision control to maintain a full model history of changes and their authors. Moreover, the Aconex BIM Viewer allows any project participant to access BIM files from within the Aconex platform without having to download the entire model or adopt special software. Indeed, the Viewer enables viewing IFC files and models are available to the entire project team, without the need to download or purchase software or downloading the full model. Additionally the fully integrated 3D viewer functionality coordinates and streamlines the review process making easier the collaboration, distribution and tracking of information and decisions. A Revit Plug-In for Aconex is available to create 2D documentation such as export and print multiple formats simultaneously (e.g. DWF, DWFx, DGN, DXF and PDF), it also allows to set predefined naming conventions based on actual Revit parameters and improve output quality with centrally managed settings (e.g. format settings for issuing drawings can be saved for future use or used across many projects).

4Projects is a provider of collaborative online software established in 2000, which develops software systems, interoperability processes and guidance in order to support BIM (<http://www.4projects.com/OurProduct/4BIM.aspx>. Last visit 5 June 2013). In February 2012 it started the project to provide capabilities which help the construction sector to meet the UK Government's target for all public sector construction projects to be utilising collaborative BIM by 2015. This is a collaborative initiative and project is delivered with the help and expertise of consortium partners Northumbria University BIM Academy, AEC3, VINCI Construction and Kingspan Ltd.

4Projects is extending the core SaaS solution to offer new BIM services, which are delivered using the existing cloud-based service model to all users. Also in this case it offers a browser-based Viewer for Building Information Models, supporting IFC files besides other formats. This allows any project member to review and interact with models without the need for any significant training, nor any specialist software to be installed. A browser-based Review System allows items and assets to be reviewed, tagged with data (such as energy usage, specification and documents). This way any

supply chain member can collaboratively review, annotate and comment upon a model, as well as associate data. Moreover, an integrated Model Server permits multiple BIM files from multiple disciplines and organisations to be merged together for collaborative viewing, review and further processing. This model provides accountability and audit trails to ensure that the latest versions of models were being used by the team and gives visibility of changes. There is also a BIM Reporting System to interrogate the model data both within the project and across many projects, enabling decisions to be made and knowledge to be re-used by future teams. The reporting engine allows several capabilities, such as production of Bill of Quantities, Clash highlighting and the ability to extract relevant data from a larger model. Additionally, a Facilities Management service supports O&M adopting the open COBie data interchange format. Finally, mobile application for accessing BIM data in 4Projects (for Android and iPhone/iPad devices) can be adopted, including the ability to view 3D models and interact with data in the project.

Asite is another company which offers an online collaboration platform (<http://www.asite.com/adoddle/government/government-collaborative-bim>. Last visit 27 June 2013). It has developed a collaboration platform called Adoddle, which allows to organise, manage and automate procurement from start to finish by streamlining tender processes. It is possible to publish tenders online, receive bids and filter them through automated processes mapped and designed by the client. The platform provides common document management services such as storage file in the cloud and organise and track files in an effective way. Moreover it gives the possibility to view over several types of files online in Adoddle without the need to download and open them in the native software. The Asite viewer supports all major Office documents, pdf, image files, CAD files and also 3D models. Thanks to this tool the user can also track paper documentation received from offline project participants, synchronise files between Adoddle and local environments, work offline and synchronise back to the server when the user is connected, see which files have changed, check-out and lock files and check-in new revisions. The platform supports also the project management and bid management creating a bidders list based on approved prequalified contractors, or through supplier searches, or via public notice. The client can communicate with the bidders to answer questions and notify bidders of clarifications, changes, or addenda. Moreover, the platform runs powerful bid evaluation and scoring reports. All the activities presented before are not directly linked to BIM. However, the peculiarity of this platform is that it connects commercial information with design detail and it enhances BIM coordination processes. Indeed, it brings visibility and control to shared Information Models and it enables a better workflow reducing errors from designing in isolation. It also reduces the risk of on-site problems with early design review and it is possible to immediately review the design progression during development. The client can centralise the storage of all versions of models in a collaborative online environment, view and walk through the overall project model and access the rich data without expensive software. Additionally, the so called 'collaborative BIM' enables to selectively share project model or individual BIM worksets with project partners, maintain a clear audit trail by tracking version control and updates to the model, merge multiple model files and worksets from different project partners and different design tools into one central model, view the differences between model file revisions and collaboratively review and mark-up model files in the integrated 3D viewer. This tool also gives the possibility to associate

views, schedules and mark-ups with workflows and track actions across the team, integrate document control and construction management with BIM coordination process and automatically generate reports such as Bills of Quantities from the model on a scheduled basis. For this reason Adoddle collaboration platform is not only a simple e-Procurement platform but it effectively integrates BIM.

Conject is a company founded in 2000 which delivers applications to clients and their authorised users on a SaaS basis (http://www.conject.com/us/en/use_cases-bim. Last visit 27 June 2013). It offers almost the same services as Asite related to document, project and bid management together with collaborative BIM. Indeed, Conject takes part in the Open BIM Network and it developed a Plan-Build-Operate application, designed specifically to operate with BIM to reduce costs and carbon emissions. Moreover, alongside other Open BIM Network members, it provided a daily public presentation detailing how a collaborative approach to BIM can help ensure that organizations can meet the UK Governments Level 2 and 3 targets. With Conject it is possible to store and share BIM files in a structured and traceable way and view Autodesk and Navisworks files. Conject is member of the BIM Technologies Alliance supporting the UK Government's Construction Strategy BIM Working Group and the Open BIM Network.

3.6 Possibilities and challenges

BIM changes the overall process of design and build and improves the technology itself (Yan and Damian, 2008). Indeed, because BIM is a revolutionary approach and it is in its early phase of development and adoption (Eastman, Teicholz, Sacks and Liston, 2011, pp. 2, 19), it brings both possible improvements and challenges. Some of these advantages are the result of increasing pressures on the Building Process, which push the traditional practise to change (Figure 3.56) (Eastman, Teicholz, Sacks and Liston, 2011, p. 20). Below there is a list of the main benefits and challenges related to the BIM adoption.

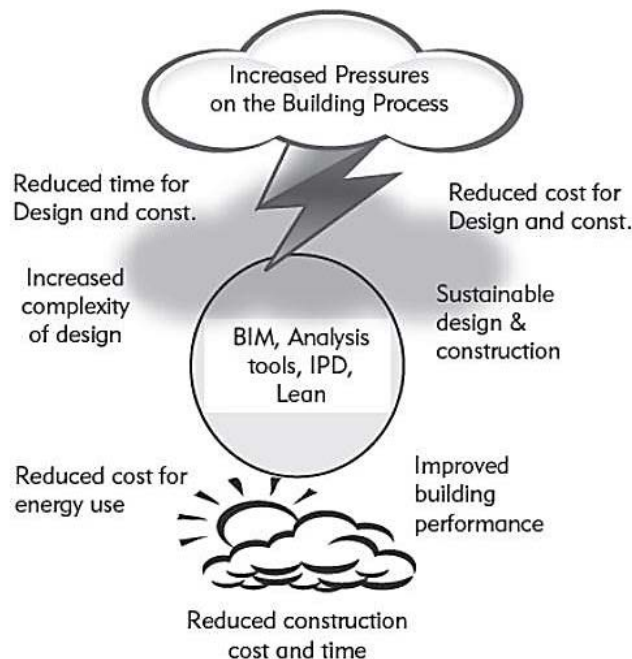

Figure 3.56. Advantages of BIM technology in answer to the increasing pressure on the Building Process (Eastman, Teicholz, Sacks and Liston, 2011, p. 20).

Reduce cost, risk and time in design, construction and operation of a facility, based on the generation of a model which can be defined as a ‘Single Source of Truth’ for all stakeholders (Saxon, 2013, pp. 10, 31). The reduction of time and cost is one of the most significant benefits, because if the time and the cost of the design phase are reduced, it is possible to arrive earlier in the construction market (Yan and Damian, 2008). Moreover, risks are reduced (Eastman, Teicholz, Sacks and Liston, 2011, p. 17), for example the safety is improved during the construction and throughout the lifecycle of the facility (COBIM, 2012, Series 1, p. 5; Foulkes, 2012) and potential claims, disputes and conflicts decrease because the grey area, that usually will cause problems later, are resolved in an earlier phase (Foulkes, 2012; Eastman, Teicholz, Sacks and Liston, 2011, p. 24).

Better final product thanks to better design and construction. The geometrical representation of the building is more accurate and it is possible to analyse and check design solution and make simulations to choose the best solution (Azhar, Hein and Sketo, 2008; COBIM, 2012, Series 1, p. 5; Eastman, Teicholz, Sacks and Liston, 2011, pp. 21, 24; Liu and Hsieh, 2011; Furneaux and Kivvits, 2008, p. 9; Furneaux and Kivvits, 2008, p. 10).

Promotion of collaboration and communication across the all parties involved in the process: BIM improves the communication between multiple disciplines, thanks to 3D models which reduce the abstraction and favourite a better understanding of design intent and conflicts (Yan and Damian, 2008; Azhar, Hein and Sketo, 2008; COBIM, 2012, Series 1, p. 5; Foulkes, 2012; Eastman, Teicholz, Sacks and Liston, 2011, pp. 21–22; Furneaux and Kivvits, 2008, p. 10).

Simple changes, update data and consistent extracted information: thanks to BIM, changes on the project do not require big efforts and the information contained in the Building Information Model can be automatically extracted whenever needed in an updated version (Yan and Damian, 2008; Eastman, Teicholz, Sacks and Liston, 2011, pp. 21, 24; Furneaux and Kivvits, 2008, p. 10). One example is a more accurate quantity take-off (Foulkes, 2012).

Potential for higher whole-life value in the built environment from comparable investment, facilitating higher energy efficiency and lower life-cycle costs (Saxon, 2013, pp. 10, 32). Also because whole-life costs are more predictable (Azhar, Hein and Sketo, 2008; COBIM, 2012, Series 1, p. 5; Eastman, Teicholz, Sacks and Liston, 2011, pp. 20–21) and data of the previous phases can be utilised during the facility management (Azhar, Hein and Sketo, 2008; COBIM, 2012, Series 1, p. 5; Eastman, Teicholz, Sacks and Liston, 2011, p. 25; Furneaux and Kivvits, 2008, p. 10). Indeed, standards such as the Construction Operations Building information exchange (COBie) can be adopted to capture and record the data as it is created during design, construction and commissioning, to support the operations, maintenance, and management of the facility (East, 2013).

Enhanced international competitiveness, with reduced importing, thanks to a lower cost and a better quality (Saxon, 2013, pp. 10, 32).

Enable offsite manufacture of buildings that favours economic, time and safety profits: BIM can drive automated manufacture (Saxon, 2013, pp. 10, 33; Azhar, Hein and Sketo, 2008; Foulkes, 2012; Eastman, Teicholz, Sacks and Liston, 2011, p. 23). BIM also allows smaller installation crews, decreasing the installation time and reducing the storage space onsite (Eastman, Teicholz, Sacks and Liston, 2011, p. 23).

Emergence of the ICT sector service as part of construction, Information and Communication Technology (ICT) can improve the construction phase (Saxon, 2013, pp. 10, 33).

As already mentioned, BIM is a new technology so it requires improvements to reach all the benefits it can produce. Below some of the main challenges related to the BIM development are shown.

Cultural change and training: BIM-based working changes are mostly cultural (Saxon, 2013, p. 22) because harmony and collaboration among players, who mostly in the past were adversaries, now are needed (Saxon, 2013, p. 88; Azhar, Hein and Sketo, 2008; *Construction Manager*, 2012a, pp. 18–19). However, the construction industry is difficult to change due to its fragmentation and the intellectual 'laziness' and the strong inertia towards renovation are a limitation (Kiviniemi, 2013), because the stakeholders usually prefer to continue their habits, instead of trying to improve the process. Even if training efforts require time, human resources and cost (Eastman, Teicholz, Sacks and Liston, 2011, pp. 186–187), they should be done to support the BIM development (Yan and Damian, 2008; Eastman, Teicholz, Sacks and Liston, 2011, pp. 27–28; Furneaux and Kivvits, 2008, pp. 27–28; Department of Business, Innovations and Skills, 2011, p. 6; McAuley, Hore and West, 2012, p. 3; Harty and Laing, 2009, p. 142; Hampson and Kraatz, 2013).

Improvement of Open BIM standards: as already discussed in paragraph 3.4, the open standards and interoperability need to be reinforced (Saxon, 2013, p. 80; Azhar, Hein and Sketo, 2008; Eastman, Teicholz, Sacks and Liston, 2011, p. 189; Furneaux and Kivvits, 2008, pp. 19–20).

Improvement of technology: usually BIM files have a large size and it is not simple to share and store them, moreover, it is fundamental to protect and access the database in real-time. For this reason developments in speed broadband internet and computer technology are needed (Furneaux and Kivvits, 2008, pp. 21–23; Hampson and Kraatz, 2013).

Single standard: a single standard should be agreed by the industry to give instructions on its application and usage. This document will reduce the current reluctance towards the BIM adoption (Saxon, 2013, p. 80; Azhar, Hein and Sketo, 2008). Moreover, new industry standards such as National BIM Guidelines are required (Hampson and Kraatz, 2013).

Alignment of BIM and Strategies for the Sustainability: the development of BIM should run parallel to the improvement of sustainability procedures to favourite the whole-life value of the facility (Saxon, 2013, p. 81; Hampson and Kraatz, 2013).

Utilisation of past BIM practise: stable teams, which can hand over their past knowledge, will be favourite so that their BIM competence will raise faster from project to project (Saxon, 2013, p. 81).

Check of competence and maturity: due to the novelty of BIM, standards are needed to measure and control the competence of firms and teams. Without an appropriate check, a wrong adoption of BIM could ruin its reputation (Saxon, 2013, p. 81).

Review of cost and benefit distribution: the compensation levels and payment need to be re-set in compliance with the new approach (Saxon, 2013, p. 81; Azhar, Hein and Sketo, 2008; Furneaux and Kivvits, 2008, pp. 20–21).

Definition of Intellectual Property Rights and authenticity of users: the sharing of information when BIM is adopted can infringe the stakeholder's Intellectual Property Rights. More attention should be paid to this issue to convince the actual reluctant contributors that their ideas will be protected (Saxon, 2013, p. 82; Azhar, Hein and Sketo, 2008; Eastman, Teicholz, Sacks and Liston, 2011, p. 187; Furneaux and Kivvits, 2008, pp. 23–26; Udom, 2012a; Udom, 2012b; Chawla, 2012; BuildingSMART, 2011a;

McAuley, Hore and West, 2012, p. 3; Harty and Laing, 2009, p. 142; Hampson and Kraatz, 2013).

Definition of the BIM owner and of the supervisor for quality: the owner of the BIM should be clear together with the definition of who is responsible of the qualities in order to be accused in case of omissions or errors (Saxon, 2013, p. 82; Azhar, Hein and Sketo, 2008; Eastman, Teicholz, Sacks and Liston, 2011, pp. 27, 187; Furneaux and Kivvits, 2008, pp. 24–25; Udom, 2012a; Udom, 2012b; Chawla, 2012; McAuley, Hore and West, 2012, p. 3; Harty and Laing, 2009, p. 142; Hampson and Kraatz, 2013).

Improvement of BIM for Infrastructure: the development of BIM for the infrastructure sector should increase together with the building one, so that tools can be communicate to each other (Saxon, 2013, p. 83).

Development of Cloud Computing: the adoption of Cloud applications to store and share the BIM data should increase to reduce cost and energy (Porwal and Hewage, 2013, p. 213). Moreover, instead of installing software on each computer, the adoption of 'Software as a Service' should be promoted, so that firms will charge only the hours of effective use and the update will be automatic (Saxon, 2013, pp. 20, 83).

Development of software applications: the Software Industry should develop tools to carry on the stakeholder's needs (Saxon, 2013, p. 83).

Review of building regulations: a renovation of the building regulations, health, safety and planning processes should be done to promote automatic checking. Time savings, reduction of uncertainty and better construction quality will be achieved if the automatic controls will be part of the statutory approvals (Saxon, 2013, p. 84; AIA, 2007a, p. 7).

Involvement of the Facility Management needs in the early phase: more attention should be paid to the Facility Management issues and their earlier participation in the process will improve the life-cycle performance of the facility (Saxon, 2013, p. 84).

Identification of exemplary projects: to improve the overall process, a list of exemplary BIM project should be done to create good practise knowledge (Saxon, 2013, p. 85). This approach will help to overcome the AEC industry's diffidence in investing in BIM, due to lack of previous experience in its financial benefits (Yan and Damian, 2008).

Integrated model: usually several models are created for different purposes, reducing the benefits of an integrated BIM process. For this reason more efforts should be made to include the requirements of different analyses in a single model (Sanguinetti, Abdelmohsen, Lee, Lee, Sheward and Eastman, 2012).

New contracts and insurance forms: BIM needs new kind of contracts and insurance forms to protect all parties involved (Saxon, 2013, p. 86; Furneaux and Kivvits, 2008, p. 25; Udom, 2012a; Udom, 2012b; Chawla, 2012; BuildingSMART, 2011a; McAuley, Hore and West, 2012, p. 3; Hampson and Kraatz, 2013). Indeed, the adoption of a collaborative form of contract is one of the fundamental steps for an effective BIM adoption (Saxon, 2013, p. 34; Eastman, Teicholz, Sacks and Liston, 2011, p. 26). PPC 2000 and NEC3 are seen as the future form of contract compatible with BIM (Saxon, 2013, p. 69).

New Procurement Methods: BIM can reach more benefits if the project participants collaborate from the beginning. For this reason new procurement processes are needed to radically change the current relationships (Eastman, Teicholz, Sacks and Liston, 2011, p. 26; Hampson and Kraatz, 2013). Integrated Project Delivery (IPD), presented in paragraph 2.4.1, could be an effective method because it supports from the early phase the collaboration between the owner, the designers and the contractor (Eastman, Teicholz, Sacks and Liston, 2011, pp. 9, 26; AIA, 2007a, p. 1; AIA, 2007b, p. 10;

Porwal and Hewage, 2013, p. 206; Succar, 2009, pp. 365–366; Salmon, 2012; Lahdenperä, 2012, p. 69; Raisbeck, Millie and Maher, 2010, p. 1020; Ilozor and Kelly, 2012, pp. 33–34). IPD will increase the speed and the flexibility of the process, reducing the risks (Saxon, 2013, p. 48) (Figure 3.57), however, this transformation requires time and education to overcome the actual barriers (Eastman, Teicholz, Sacks and Liston, 2011, p. 27).

The WSP group, an engineering and design consultant service provider, in 2011 commissioned a report to Kairos Future, international research and consulting firm, to identify ten major themes, called ‘truths’, to investigate how BIM is perceived around the world (Kairos Future, 2011). Some of them deal with how BIM is perceived today, others with how BIM will influence the AEC industry and the barriers to change, and the rest with the issues that are more visionary and consider the long-term consequences, where BIM can become ‘the information backbone of a whole new industry’ (Kairos Future, 2011). The 10 truths about BIM are:

1. BIM takes design to the next level: thanks to 3D, it is possible to generate complex shapes and software can handle sophisticated calculations which allow engineers to create more audacious designs.
2. The ‘I’ is more important than the ‘B’: BIM is an information management tool, however, by now too important has been given to ‘building’ rather than ‘information’ and this caused a slow BIM adoption in the civil engineering sector.
3. The colour of BIM is green: if properly used, BIM will cut time and thereby energy use, together with cost. Indeed, BIM will contract the waste of materials during construction and facility management and eventually assist in sustainable demolition. Thanks to Energy modelling it is also possible to minimise energy during the life-cycle of the building.
4. BIM will destabilise the construction industry: unlike CAD, which computerised a single activity without changing the macro processes, BIM will modify everything.
5. Governments must take the lead: the benefits coming from BIM only can be achieved only through close collaboration among the project. To make the investment worthwhile, someone has to break the stalemate and the government has a key role.
6. Companies must work together as one: BIM both enables and requires close integration so firms and disciplines must stop to work separately and interact only through the exchange of construction documents.
7. Both the software and the professionals must work together: this implicates to change habits and routines in order to make cooperation natural. Moreover, the software will need to be developed to allow seamless integration.
8. New contracts will emerge: both digitalisation and close collaboration challenge the prevailing system of intellectual ownership. Two possible development routes are outlined: the first supports increased specialisation where ownership resides with modelling specialists; the second, instead, deals with the consolidation into giant firms, as companies work increasingly closely, solving ownership issues.

9. The software platform is at a crossroads: the fight for supremacy in the software world rages on. Depending on the outcome of current power struggles, the digital environment will conform to one of three types: open standard, closed and proprietary standard, or no/several standards.
10. BIM will become the DNA of future construction: when the system is sufficiently streamlined it is possible adopt it. Once the basic information infrastructure is in place and the learning process has been completed, several technologies, in use or in process, can be brought in.

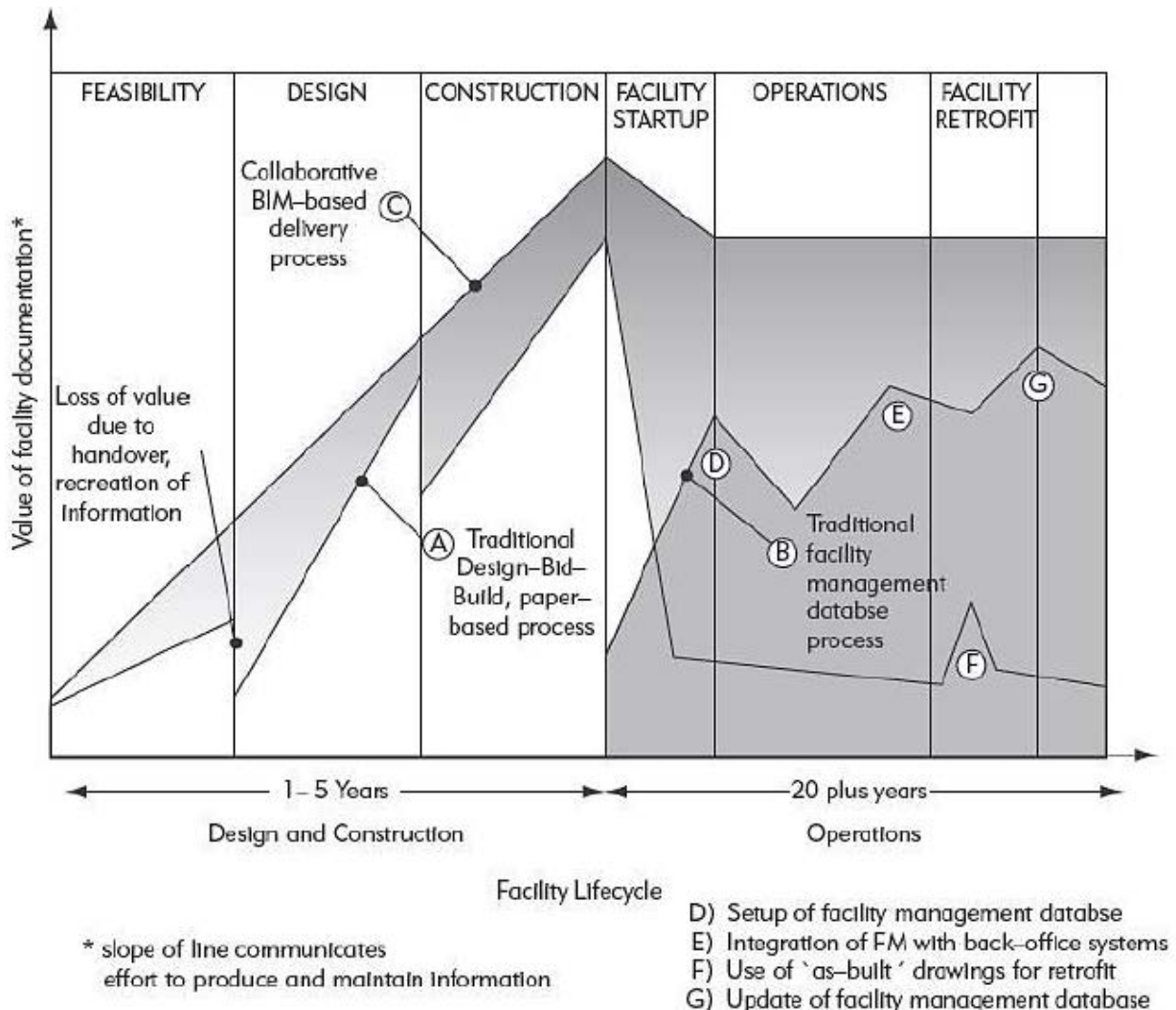

Figure 3.57. Comparison between traditional DBB paper-based process and collaborative BIM-based delivery process (Eastman, Teicholz, Sacks and Liston, 2011, p. 153).

Finally, in 2008 Yan and Damian published an article related to the benefits and barriers of BIM, based on literature review and results of questionnaires sent to AEC industry practitioners and academics especially of USA and UK. Figure 3.58a and Figure 3.58b mirror the main results.

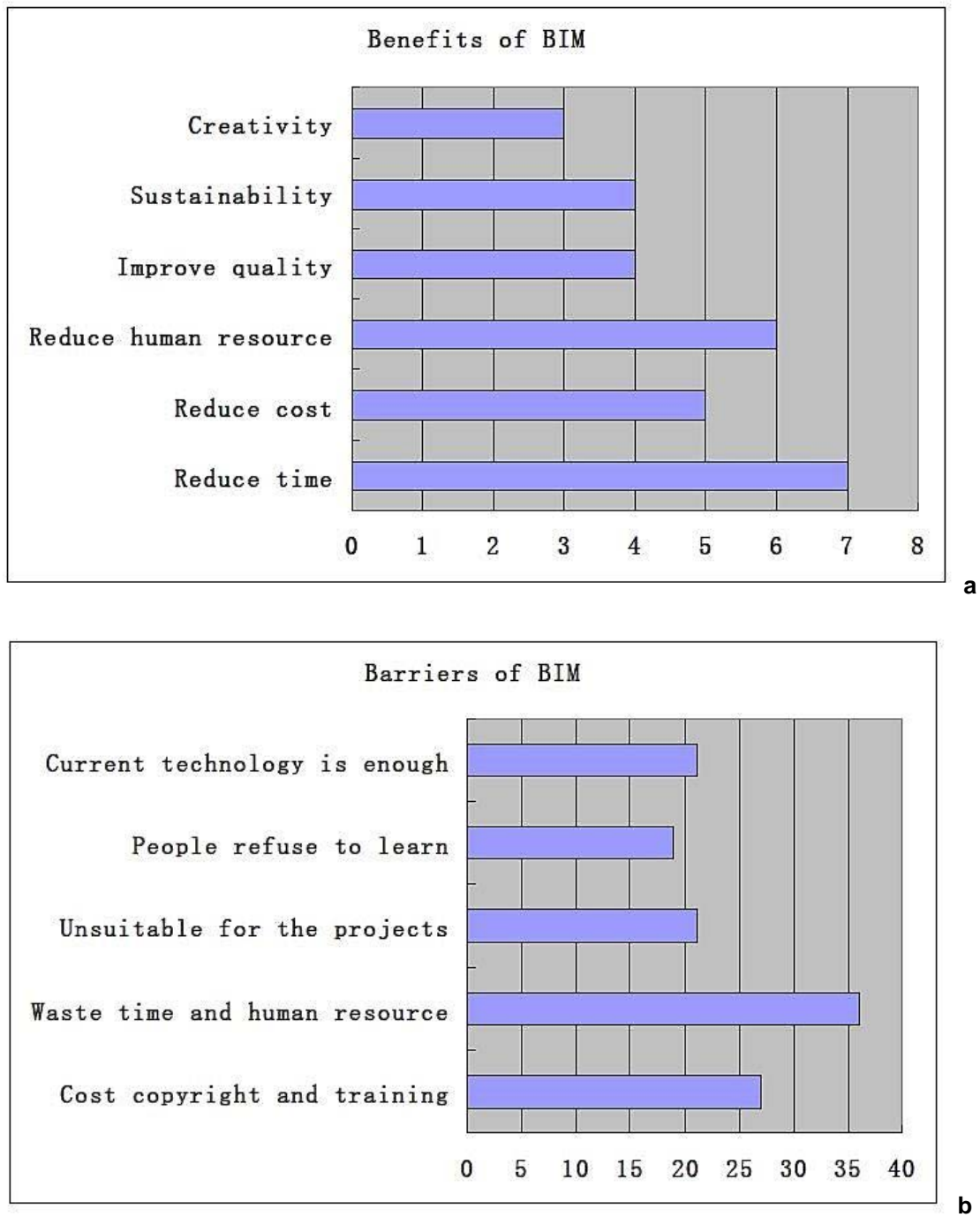

Figure 3.58. (a) Advantages of BIM (Yan and Damian, 2008) and (b) Drawbacks of BIM (Yan and Damian, 2008).

4. Possible Implementation of BIM in Tendering

4.1 BIM and Procurement

Nowadays the BIM adoption is limited in the construction industry, mostly due to lack of BIM demand by clients, who cannot recognise its importance. The Government agencies are still focused on 'paper-based' procurement approaches and as a result much information is miscarried and misinterpreted (Eastman, Teicholz, Sacks and Liston, 2011; Liu and Hsieh, 2011; *Construction Manager*, 2012a, p. 21). Subsequently, this attitude creates design negligence, omissions, conflicts, miscalculations, and inconsistencies between drawings, specifications, and other contract documentation. These problems usually generate delays and disputes among the client, designers and contractors and usually the final price differs from the tender (McAuley, Hore and West, 2012; Eastman, Teicholz, Sacks and Liston, 2011; Roginski, 2011). Indeed, the contractors usually present under-priced bids in order to win, later recovering their profits from claims based on the always imperfect information provided by the client (*Construction Manager*, 2012a, p. 21; Racca and Cavallo Perin, 2012, p. 4; Hopper, 2012). BIM dramatically increases the completeness and consistency of tender information, forcing tenders which are similar to the final account (Saxon, 2013, p. 61; *Construction Manager*, 2012a, p. 21). Moreover, BIM allows much more complete and consistent information to be produced by consultants so that bidders cannot hope to bid low and make a profit later from weaknesses in consultant information (*Construction Manager*, 2012a, p. 21). Honest bidding is effectively enforced (Saxon, 2013, p. 49; *Construction Manager*, 2012a, p. 21). Indeed, the BIM consultant Ray Crotty, during an interview for *Construction Manager* (2012a, p. 21) figured out the current situation together with the consequences of a BIM-based approach for the construction industry: 'competition among contractors today is mainly about the marketing and estimating skills and commercial nerve required to win work, and the claims management skills required to make money from projects won at cost, or less. Skills in construction operations may give project teams a sense of pride and achievement, but are largely irrelevant to the survival of the firms they work for. So contractors, with no existential imperative to innovate, avoid innovation risk, and avoid investing in improved production methods. As a result, effective competition exists only at the top and bottom ends of the construction industry: competition of ideas among designers; and product competition among manufacturers. Everyone in between competes to win projects — they do not compete to deliver them. This is a crucial, crippling distinction. Imagine how trustworthy, computable tender documents might transform this situation. With perfect, complete scope definition, bidders are compelled to compete on the basis of their ability to do the construction work. Every line item can be linked directly with a component in the model and

must be priced explicitly. Every price can be compared automatically and challenged as appropriate. There are no claims opportunities, so bidders must get it right going in. Contractors will be compelled to compete directly on the basis of the productivity of their project delivery techniques. Efficient firms will profit greatly — they're no longer going to be undercut by claims-hunting predators. Construction as a whole will become wealthier, able at last to invest seriously in people, methods and physical capital; labour productivity will soar. The precision and computability of model-based designs enable physical components of buildings to be machine made directly, using the data contained in the modelling systems. The idea of 'tolerance' will disappear; individual objects will be manufactured with perfect precision and pre-assembled in the factory, before being shipped to site. No manufacturing from raw materials and no shaping operations — no pouring, cutting, routing, drilling, bending, folding of components — will take place on site. It will also be a super-fast-track industry. Knowing that the other elements of the building are being assembled exactly as designed means that, instead of having to wait to check whether earlier elements have been built correctly, the manufacture of all components could, if required, commence simultaneously, and proceed in parallel, as soon as the model has been completed'. Crotty also affirmed that 'just as guarantees are an important attraction to buyers of cars and other complex products, long guarantees are likely to drive the market for buildings of the future. Suppliers will emerge that will offer, say 20-year guarantees covering all the performance characteristics of a building. This will include the maintenance performance of the fabric of the building and the equipment within it, the building's energy performance and even the ease with which it can be re-configured for new uses. The suppliers of these buildings will aim to derive as much of their revenues from servicing the product in its life in use as from the initial sale. This mode of operation will ensure that buildings of the future will be designed and built to optimise their whole-life costs. It will also require that performance feedback loops become an integral part of the operation and maintenance of future buildings, ensuring that their suppliers become real learning organisations, with a commitment to the on-going maintenance and operation of their products'.

In order to achieve these benefits, BIM amendments are going to be adopted by the European Parliament's Internal Market Committee as part of its report on the General Public Procurement Directive (2013) in October 2013 (*Construction Manager*, 2013). Indeed, '(...) the submission of building information electronic modelling tools for works contracts should be encouraged in order to modernize the procurement process and ensure greater efficiencies are achieved in the public procurement of works covered by this Directive, in particular in relation to taking into account life cycle costs and sustainability criteria' (European Parliament, 2013, p. 22). Therefore, 'for works contracts above the threshold set out in Article 4, Member States may require the use by both contracting authorities and tenderers of building information electronic modelling tools following the general timescales for the implementation of electronic procurement set out in the first subparagraph' (European Parliament, 2013, pp. 62–63). After the Directive will be published, Member countries would then have to pass national legislation to enshrine the directive in law (*Construction Manager*, 2013). It is interesting to note that the BIM implementation will be 'encouraged' and will not be mandatory. Even if the EU is taking some steps forward, this is not enough for a full BIM development: a compulsory requirement would have been more effective.

Indeed, the role of Public bodies is fundamental because the ‘government as a client can derive significant improvements in cost, value and carbon performance through the use of open sharable asset information’ (Department of Business, Innovations and Skills, 2011, p. 15). Moreover, the amendments to the EU Directive should persuade the contracting authorities to exploit the computable data and information during tendering, instead of only encourage Public Clients to give Building Information Models or ask for being provided with them. The EU’s precautionary approach shows that BIM is still under development and even if benefits have already been proved, a lot of effort is required to establish it.

In this chapter an analysis related to the possible implementation of the BIM technique in the Public Procurement is carried out. More specifically its role in the Tender phase is discussed, in an attempt to underline the critical aspects when BIM is provided (implementation of BIM in Design-Bid-Build) and when it is requested (implementation of BIM in Design-Build and Design Competitions) in the technical section of the call for tender. An important part of the bidding process is the evaluation of the several proposals and the later awarding phase. The implementation of BIM, and particularly the Model Checking function, can improve the effectiveness of the process through streamlining, simplifying and making the evaluation as objective as possible (Hjelseth, 2012). For this reason a paragraph is dedicated to Model Checking in the estimation of design proposals, showing what it is possible to check adopting the main current commercial software, such as Solibri Model Checker (SMC). Another paragraph presents some examples available in literature where BIM has been adopted in tendering. Finally, a paragraph describes the possible implementation of BIM for an Italian case study.

4.2 Implementation of BIM in Design-Bid-Build

4.2.1 Introduction

Even though the adoption of BIM in the tender phase is still limited, it can significantly improve the overall workflow (COBIM, 2012). In this paragraph an analysis of the possible adoption of BIM in the Traditional/Design-Bid-Build (DBB) procurement method is shown, taking into account the main tasks of the Client, the benefits for both the Client and the Bidders and potential problems. The information comes from published documents and interviews conducted in Finland from October 2012 to March 2013.

4.2.2 Client’s Obligations

The main problem when BIM is utilised in DBB, especially in tendering, is that up until now it is not an official tendering document. If the client provides a Model, usually it is not part of the official tender documentation and so its application is compromised because the tenderers cannot totally rely on it.

According to Porwal and Hewage (2013, p. 204) ‘the best way for a technology to be accepted is when the client/owner imposes it in the contract, since it is not negotiable’. This statement is valid for the adoption of BIM in a more general context but it is particularly true for the public sector, where it would be necessary to make BIM a mandatory requirement in all public projects. Saxon (2013, p. 11) says that ‘there is no doubt that the policy of mandating BIM use for government work will create economic growth. The

scale and speed of the effect is not quantifiable as yet but should become so if monitoring is well done'. In this light, the Public Procurement Contract should be revised to incorporate the adoption of BIM (Liu and Hsieh, 2011; McAuley, Hore and West, 2012). Up until now two BIM specific contracts have been developed in US to facilitate its usage: the ConsensusDOCS 301 (Lowe and Muncey, 2009), AIA E202 (AIA, 2008) and AIA E203 (AIA, 2013); moreover, in 2008 some amendments were introduced to PPC2000 (ACA, 2008). Also JCT contracts are suitable for BIM projects and recently it has taken further steps to address the integration of BIM and construction contracts by establishing the JCT BIM Working Group (JCT, 2013). In April 2013 a new guide 'NEC3: How to use BIM with NEC3 Contracts' was published. It explains how BIM should be incorporated into the NEC3 standard forms and it suggests additional clauses to be added into the some of the main NEC3 contracts to facilitate the BIM adoption. Finally, in 2013 the BIM Employer's Information Requirements was published and in Finland a BIM project guideline for Clients is to be published (Tietomallihankkeen tilaajaohje 1.0).

If BIM is an official tender document, the client is responsible for its content and the design team must check its quality (COBIM, 2012, Series 6, p. 19) before delivery to the bidders. In this way the contractors do not have to check and eventually correct models themselves anymore. The models should be generated following a specific BIM manual or part of it (e.g. COBIM) in order to avoid common errors (such as wrong layers, space objects or types). Moreover, the content of models should be appropriate to allow the bidders to obtain reliable quantity take-off and, as a consequence, trustworthy bidding prices (Roginski, 2011).

When BIM is adopted the BIM Specification is essential to reach optimal results. Indeed, the design team must edit a document in parallel with the model creation to describe its content, level of precision and purpose, updating any relevant changes. This document must also contain the modelling software used, the different versions created from the original model and possible exceptions to these specifications. It is useful to include the naming convention adopted and the maturity of the content to understand how to utilise it and whether there are any restrictions (COBIM, 2012, Series 1, p. 10). It is also possible to call it Model Specification or Model Description Document. The design team has to deliver both the Building Information Model and this text document to the client, who, in turn, must give them to the bidders. Today the adoption of models is not advanced enough to provide all the information required in the tender phase, so the client is allowed to furnish both the BIM and 2D drawings. When both documents are available it is of outmost importance that the information is not in conflict. The designers should extract the 2D information from the Model and, if necessary, add data, but there must be compliance between the two (COBIM, 2012, Series 13, p. 5).

Even if it is not preferred, there might be the need to utilise traditional 2D drawings not derived from the information contained in the Model; in this case the BIM Addendum ConsensusDOCS 301 (Lowe and Muncey, 2009) can be adopted to define the relation between the different data. It is an *addendum* to standardise the agreement between owners, design professionals and contactors (the *Project Participants*), published in 2008 by the ConsensusDOCS and dealing with Building Information Modelling. It can be a contract document in traditional project delivery methods (e.g. DBB) and it can be used in such a manner that Models can coexist on a project with traditional 2D drawings (not extracted from the BIM). In fact 'on some projects, it may be

more practical and more cost-effective to draw certain details rather than to model them' (Lowe and Muncey, 2009, p. 3). If needed, the parties can select an order of precedence between models and drawings. The BIM Addendum provides three different options to identify their level of reliance in case of contradictions. The first affirms that the model takes precedence over 2D drawings. The second gives reliability to the model only for the information specified in the BIM Specification, for the other data the 2D drawings must be consulted. The third, instead, gives the priority to 2D drawing and the model is used only as a reference.

In addition, the BIM Addendum considers a fourth option that the client can adopt to specify a different level of reliance between the model and the 2D drawings.

Finally, another interesting topic is the most suitable file format to be included in the tender documents. The implementation of standards and protocols with a common language is essential in the adoption of BIM in public works. In fact, adopting file formats not bound to specific software packages is very important because the information can remain 'open and non-proprietary' (Porwal and Hewage, 2013, p. 206). Nowadays IFC is supported among the major BIM software vendors also thanks to different public sector property owners' desire to support BIM with IFC standards (for more information see paragraph 3.4). However, there are still problems in generating IFC files, which, for example, do not always correspond to the native ones. For this reason, at the moment it would be better to provide the tenderers with the native file as well. Moreover, if the purpose of BIM is only a better visual understanding of the complexity of the project and it will not be used for quantity take off (QTO), an alternative to the IFC format would be a non-editable file. Indeed, the Los Angeles Community College District (LACCD) in its Standards for Design-Bid Build Projects (2001, p. 19) affirms that 'as part of documents delivered to potential bidders, Design Team shall provide non-editable version of the coordinated BIM for reference and visualisation of the building' and only 'after Contract is awarded, the coordinated Design BIM and all native BIM files will be provided to the General Contractor'. However, in this case BIM cannot express all its potentialities and these formats usually are not supported by the majority of visualisation tools (e.g. Solibri Model Viewer). Figure 4.1 shows the main points dealing with the client's tasks: they should include BIM in the tender documentation, together with model specifications and possible 2D drawings in compliance with the Model.

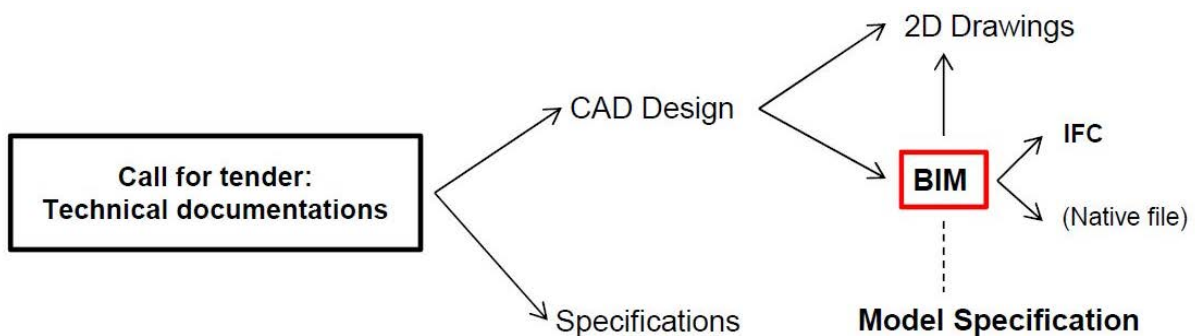

Figure 4.1. Diagram of the main aspects of the client's obligations in DBB.

4.2.3 Benefits for the Bidders

If the clients provide BIM as part of the tender documentation, the bidders can understand the complexity of the project better and faster (Vianova Systems, 2013). So the improvement of the visualisation is of course one of the benefits for the bidder (COBIM, 2012, Series 1, p. 20).

However, as already discussed in Chapter 3, BIM is not a simple 3D model, but it contains data which can always be consulted and extracted. In this case, a bidder is able to take off quantities from the Model and prepare a cost evaluation (COBIM, 2012, Series 1, p. 19) faster and more accurately (Vianova Systems, 2013; Roginski, 2011). Indeed, the final cost will be a rapid by-product of the model with important savings available thanks to more precise quantities (Saxon, 2013, p. 50). For this reason the final offers will be more reliable and the gap between the tender price and the final one will be reduced (Roginski, 2011). The quantity take off can be used also to generate a time schedule and a draft of the supply chain management, if requested in tendering. Thanks to an easier way to calculate quantities the bidder can save money and prepare a more convenient offer.

Indeed, a quantity surveyor of a Norwegian contractor company says that 'we would like to receive models with as much data as possible. We are part of an industry with fierce competition, where a project profitability of 5% is good, so anything that can help calculating the right price is important. The margins are small. BIM models definitely help us to 'tune' our pricing, using the right methods and capacities' (Vianova Systems, 2013). For this reason Building Information Models can generate insights on the project and help price the bid as accurately as possible (Vianova Systems, 2013).

4.2.4 Benefits for the Client

The client can also obtain benefits from the usage of BIM. First of all because if the bidders save money in the cost estimation and they are more precise in calculating quantities, they are able to offer the client a more accurate and reliable bid. Moreover, the risk of later claims will be reduced thanks to the BIM process, which avoids ambiguity and conflicts between the information in the tender documents (Saxon, 2013, p. 61). Indeed, BIM assures the congruence between the 3D model and 2D drawings, because all documents are linked and when a change is made to one part, the others are automatically updated and coordinated. For example if the position of one wall changes, the designers do not have to change it in all the 2D drawings which show it, but they have to modify only the 3D model and the linked 2D drawings are automatically updated.

4.2.5 Limitations and Potentialities

The adoption of BIM in the DBB procurement method can improve the process but it cannot express all its potentiality due to the structure of the delivery method itself (Salmon, 2012). Indeed, the later involvement of the contractor is not ideal because they are not able to participate in the design process (Eastman, Teicholz, Sacks and Liston, 2011, p. 10; Roginski, 2011).

Moreover, the benefits for both the client and the bidders are better if they have good skills and past experience in working with BIM. A learning process is needed to achieve all the potentialities of BIM, also because there might be some hidden information in

the Model and the content might not be clear enough to provide a reliable offer (Rakennuslehti, 2013a). Nowadays, indeed, not everybody is sure about the possible benefits because they are afraid that the 'automation' in the process will decrease the awareness of the contents of documents (Rakennuslehti, 2013b). In addition, contractors have the initial costs of buying software compatible with the models, so not everyone is able to implement new technologies, therefore, the quantities are still mostly calculated in the traditional way (paper or .pdf based measurements) (Rakennuslehti, 2013b). The future approach, instead, will force to explicitly price each item linked with a component in the model so every price will be easily compared and the opportunity of claims will decrease (Construction Manager, 2012a, p. 21).

Even if 'the bills of quantities and cost estimates generated from the BIMs can be included in the mandatory tasks of a BIM-based process' (COBIM, 2012, Series 1, p. 19) there are still some problems. For these reasons, 'in addition to BIM-based bills of quantities, it will be necessary to survey also quantities by traditional methods, because modelling is not, at least currently, capable of covering all of the required information' (COBIM, 2012, Series 1, p. 19).

At the end of the tendering phase only one bidder will be awarded the contract, so all the others will 'lose' the money invested for the development of the final offer. The implementation of BIM can reduce the effort in the cost estimation and reduce the economic loss of the bidders who will not be awarded the contract. A member of the Finnish organisation Senate Properties introduces an interesting point of view related to the client's future responsibility in tendering (*Rakennuslehti*, 2013a). Today the bidders are responsible for quantities but if it becomes the client's responsibility, in their opinion the number of offers will increase. Of course nowadays there is a waste of money and effort in the QTO because all the bidders have to calculate the same quantities. If the client provides the list of quantities, there will be cost savings and the process will be more efficient, however, the client must assume new responsibility and new risks. The adoption of BIM, which gives the possibility for more reliable quantities, maybe will convince the client to accept this task in the future.

4.3 Implementation of BIM in Design-Build or Design Competitions

4.3.1 Introduction

This paragraph presents an analysis of the possible adoption of BIM when the client asks for it. In particular the Design-Build (DB) procurement method and the Design competitions are taken into account, showing the main tasks of the Client, the benefits for both the Client and the Bidders and the potential problems. The information comes from published documents and interviews conducted in Finland from October 2012 to March 2013.

4.3.2 Client's Requirements

According to several authors, BIM is particularly beneficial for DB procurements because a single entity is responsible for both design and construction (Eastman, Teicholz, Sacks and Liston, 2011, p. 10; Foulkes, 2012). However, Saxon (2013, p. 46) purports that, even if the DB process can still be adopted in many different ways to

satisfy clients and suppliers, these ways differ from the current practices and involve learning and different processes. In fact roles and relationships change and all the stakeholders need to modify their work plans and business models to utilise BIM fully.

Usually in DB the bidders receive a set of Client's Requirements documents and from this information they have to develop the design, arrive at a price and submit a bid. Today this process is not always successful because of the insufficiency of the documents provided: 'the requirements are unclear, elements are missing, scope is not adequately defined, either because the documents are weak in themselves, or because the client has not effectively communicated his requirements to his design team' (Foulkes, 2012). For this reason the offers are not in compliance with the client's needs and changes must be made at great cost. Moreover, clients are not usually experts in the construction process and the comprehension of 2D drawings is not always intuitive. The implementation of BIM can improve communication and the clients, thanks to the 3D model, can walk through the model to verify if the proposal is in compliance with their requirements. The control is not only a visual one but the client is able to use Model Checking tools to analyse the contents of the bids. A more detailed description of Model Checking will be provided in the next paragraph (4.4 Model Checking in the evaluation of design proposals). In order to check the compliance of the offers with the tender documentation, a set of well-structured BIM requirements must be provided for the bidders. It is essential that, from the beginning, the client has a clear idea of what they would like to control. Only in this way will they be able to prepare complete requirements, which will be useful for bidders to create a Model ready to be then checked by the client. The success of the project derives from the set of appropriate BIM Requirements and tender documentation must be explicit regarding requirements and expected operation and maintenance costs (Hopper, 2012).

For this reason the most important aspect is to define the final aim of the model and what will be checked to define the list of requirements (e.g. if the client would like to check the area dimension of spaces, the model should contain spaces). Secondly the awarding criteria must be clear and the evaluation process should be described, as already happens nowadays, but with more attention paid to new aspects (such as the definition of the tolerance adopted in some model checking tools).

The client could include in the tender documentation all or parts of already published BIM guidelines (e.g. COBIM or Statsbygg Building Information Modelling Manual Version 1.2 (SBM1.2)) to give indications how to generate the model. An example is the Appendix 5.6 'Digital 3D model and BIM requirements' attached in the Architectural Competition for the new National Museum at Vestbanen in Oslo (for more information see paragraph 4.5.3), where part of the SBM1.2 has been attached. The appendix 1 included in Series 5 of COBIM (2012) shows the content of a structural model for the tender design phase. It could be utilised as a reference for preparing the client's requirements indicating the structures, the building parts, if they are mandatory or optional and their accuracy.

Each client can include different BIM specifications but at least they should incorporate indications related to:

- File formats (only IFC or also native file format)
- Coordinates system and units
- Level of detail/accuracy of the model

- Modelling tools (all model elements should be modelled using the intended components and tools)
- Conventions of objects-naming
- File naming
- Model structure
- How to prepare the BIM specifications
- Define a room programme with the room specific area and special requirements;
- Identification of Spaces (e.g. space ID, function, name).

Moreover, the client should provide a Model of the existing site and buildings (COBIM, 2012, Series 2, p. 19; Statsbygg, 2011, p. 63) to facilitate the bidders' work. For this reason the client should develop 3D Scanning Technology because it can be useful not only in the early phases of the project, but also during its life-cycle. Recently the UK BIM Task Group (2013c) published the 'Client Guide to 3D Scanning and Data Capture', which describes its applications and benefits for clients, the process, the procurement and the relations between BIM and 3D Scanning. Thanks to this technology it is possible to capture existing conditions in a highly accurate 3D format which can be utilised as a basis for developing project designs (BIM Task Group, 2013c, p. 23) by bidders.

In addition to the existing conditions, a BIM space programme (as in the Architectural Competition for the new National Museum at Vestbanen in Oslo, for more information see paragraph 4.5.3) should be provided to help the bidders in their final submission.

As already discussed in paragraph 4.3.2, the best file formats to be used in public works are the 'open' ones like the IFC. The client should ask for IFC files not to oblige anyone to utilise specific commercial software. In this way the bidders are free to choose the most convenient software for them and the client is able to open the IFC with different software. However, the IFC format is still not perfect and there could be some problems in using it (for more information see paragraph 3.4). For this reason the client could also ask for the native file in this period of transaction, even if an enormous effort is needed to have all the licenses of different versions of commercial software.

The Client should also enquire about the bidders' previous experience in BIM (Building Information Modelling (BIM) Task Group, 2013; Eastman, Teicholz, Sacks and Liston, 2011, pp. 178–179). Recently PAS 1192-2:2003, a Specification for information management for the capital/delivery phase of construction projects using building information modelling has been published. Chapter 6 is dedicated to the procurement phase and in particular paragraph 6.3 describes the Project Implementation Plan (PIP), a document to 'assess the capabilities, competence and experience of potential suppliers bidding for a project' (British Standards Institution, 2013b, p. 14). Moreover, the Construction prequalification questionnaires have been updated by the British Standards Institution with questions related to the organisation's understanding, capability and willingness in using BIM (2013a, pp. 23–24). In addition, these questions could include the request for a description of the abilities to manage the whole process and also the submission of previous Models (or examples of the content of the BIM Library, such as for the new Royal Adelaide Hospital in Australasia. More information is available at paragraph 3.5.3). In the latter case the client does not require only the list of projects but also the BIMs to be checked to have an idea of their quality. For this purpose

a new tool 'Result Summary' of the commercial software Solibri Model Checker v8.1, could be used to quickly evaluate several IFC models (more information is available in paragraph 4.4.2).

4.3.3 Benefits for the Client

Thanks to the 3D visualisation, the client can understand the offers better and they can find more information in only one file, instead of searching for it in different documents (Foulkes, 2012).

Moreover, using BIM, the contractors are more aware of the content of their final submission because they are able to manage the process more carefully; for this reason the client can receive more reliable offers.

Another important benefit for the client is the possibility to check the compliance between their requirements and the bids, thanks to model checking tools. In this way the control is not only manual but it can be automatized and the comparison of alternatives is simpler. Indeed, for Statsbygg (2011, p. 63) 'the main objective for BIM requirements in an architectural competition is to achieve easy, fast and equal assessment of the competition proposal'.

4.3.4 Benefits for the Bidders

As already stated, thanks to BIM the bidders have a higher control of the overall design process so they are able to provide more accurate and reliable bids, reducing their risk. For this reason they feel more confident when handing over the tender, both in terms of pricing levels and in terms of construction capability (Vianova Systems, 2013). Indeed, they can develop the design and control costs at the same time, since the calculation of quantities is easier. Building Information Models also facilitate the discussion of alternative solutions during the planning meetings (Vianova Systems, 2013).

Moreover, the bidders can utilise model checking tools to control their proposal, thereby avoiding most errors before the final submission.

4.3.5 Limitations and Possibilities

When BIM is required and the bidders are able to set up the process from the beginning or if they receive a BIM to be developed, more benefits are achieved (Foulkes, 2012). The Contractor is able to manage the process from the early phase and the client can start to understand the design intent and evaluate the bids using tools such as SMC, which can support and improve the evaluation phase. For this reason the implementation of BIM in the DB procurement method is more advisable than in the DBB one (Eastman, Teicholz, Sacks and Liston, 2011, p. 10; Liu and Hsieh, 2011, p. 763).

As already discussed, the success of the process is mostly related to the preparation of accurate BIM requirements, which can help the bidders to provide their submission, but also allows the client's evaluation and comparison of Models against requirements in a more effective way (Statsbygg, 2011, p. 63). Nowadays most clients are not always aware of BIM potentialities and they do not know what to demand and how to control the new process, for this reason a learning approach is needed to reap all the benefits from BIM (Kiviniemi, 2010 Salmon, 2012). Each Government should publish

national BIM technical specifications, BIM Agreements and Requirements, taking into account those already published (e.g. COBIM 2012, GSA BIM Guide, SBM1.2) (Liu and Hsieh, 2011) to simplify the preparation of the BIM Requirements of each public tender. A learning process is needed also for the tenderers to become familiar with BIM to follow the tender specifications and have all the benefits.

Moreover, also in this case, Public Works Procurement Contracts should be revised to incorporate the implementation of BIM. The ConsensusDOCS 301 (Lowe and Muncey, 2009), AIA E202 (AIA, 2008), AIA E203 (AIA, 2013), JCT, NEC3 or the Finnish BIM project guideline for Clients (Tietomallihankkeen tilaajaohje 1.0) can be used as reference for this purpose. In particular the legal issues (e.g. Risk Allocation and Intellectual Property Rights) should be scrupulously faced because they are still delicate arguments due to unfamiliarity with BIM. Finally, BIM can be a useful support in case of claims because it provides needed information to prove the guilt or innocence of parties involved in the process (Gibbs, Emmitt, Ruikar and Lord, 2012, pp. 41–42). Hopper (2012) suggests that a standard BIM Addendum may resolve some of the confusion around existing contractual documents. The BIM Addendum should include five key elements to support early collaboration on BIM projects: Project-based BIM-Plan, Object Author Matrix, Level of Detail Schedule at each Stage, BIM-Delivery Schedule and BIM Authorised Uses Schedule.

4.4 Model Checking in the evaluation of design proposals

4.4.1 Introduction

By referring to Mohemad, Hamdan, Othman, and Noor (2011), the selection of the most qualified contractor is still one of the most critical issues for a project to be successful and the decision-making process becomes complex with the presence of unstructured and ill-defined information. Moreover, 'human being decision maker tends to provide unfair and bias decision based on incomplete, insufficient and unorganized internal and external knowledge'.

Nowadays most of the Public Clients require 2D documents and Information Modelling is seldom used (Liu and Hsieh, 2011). Consequently, without an Information Modelling-Based Approach, Public Clients have no chance to accurately check the compliance between the bid's contents and the required rule sets. Model checking can improve the process (Greenwood, Lockley, Malsane and Matthews, 2010) and help the client in the selection of the best contractor.

There is no official definition of Model Checking and usually the terms rule checking, validating, code compliance checking and automated rule checking are used as synonyms. It is performed on a model and, specifically, on the information contained (Hjelseth and Nisbet, 2010). Automated rule checking is defined by Eastman, Lee, Jeong, and Lee (2009, p. 1012) as 'software that does not modify a building design, but rather assesses a design on the basis of the configuration of objects, their relations or attributes. Rule-based systems apply rules, constraints or conditions to a proposed design, with results such as 'pass', 'fail' or 'warning', or 'unknown' for cases where the needed data is incomplete or missing'.

In literature there are several examples of efforts to automate rule checking in buildings well described by Eastman, Lee, Jeong, and Lee (2009) and Greenwood, Lockley,

Malsane and Matthews (2010) (e.g. CORENET System by Singapore, the HILTOS project by Statsbygg, works by the Australian Building Codes Board, the SmartCODES by the International Code Council, efforts by the General services administration and the Public Building Service in U.S. as well as minor research implementations of rules for accessibility and fire codes).

To effectively check requirements within a BIM process, Computable requirements and Designs built using standardised BIM objects are needed. Indeed, Client requirements must be written in a way that they can be turned into computable rules and a Building Information Model including the necessary information must be available to perform Model Checking (Hamil, 2013).

In this paragraph a possible implementation of Model Checking in tendering is shown also taking into account its limitations. Nowadays Model Checking is seldom utilised in this phase, even if some requirements included in tender documentation can be easily translated into a ruleset and be checked by clients.

Model checking tools can be useful also to Bidders, facilitating them in the configuration of their bids in order to comply with contractual requirements, making a sort of self-assessment easier.

Moreover, the Public Client does not need to have model-based design skills in their organisation, but they must be able to check the compliance between the content of BIM and their requirements (Tietomallihankkeen tilaajaohje 1.0). Model checking is one of the most powerful ways to control it not only in the tender phase but also during the entire process. Indeed, it provides rules prone to quickly find either conceptual or geometric conflicts (Hjelseth and Nisbet, 2010; Soto and Carlsson, 2013). Such a method allows for improvement in the effectiveness of the Public Procurement Routes and in particular the evaluation work of the jury.

4.4.2 Model Checking tools

A short description of the main commercial software, which can support BIM-based tendering, is provided:

- Solibri Model Checker
- EDM Model Server
- dRofus
- Affinity
- dProfiler
- Autodesk NavisWorks
- Tekla BIMsight
- Bentley Projectwise Navigator
- Riuska
- Autodesk Ecotect
- EasyBIM
- Vico Cost Planner
- Mitchell Brandtman
- Solibri Model Checker.

Solibri Model Checker (SMC) is a rule-based checking and auditing tool which gives the possibility to check Models in IFC format for 'potential problems, conflicts, or design code violations, and also includes visualisation, walkthrough, interference detection,

model comparison, and information take-off capabilities' (Khemlani, 2012b). SMC is based on Java and it offers a set of built-in rules and rule configurations based on parameters. Indeed, it is possible to prepare new rules, by changing the predefined ones with the Ruleset Manager tool (Figure 4.2).

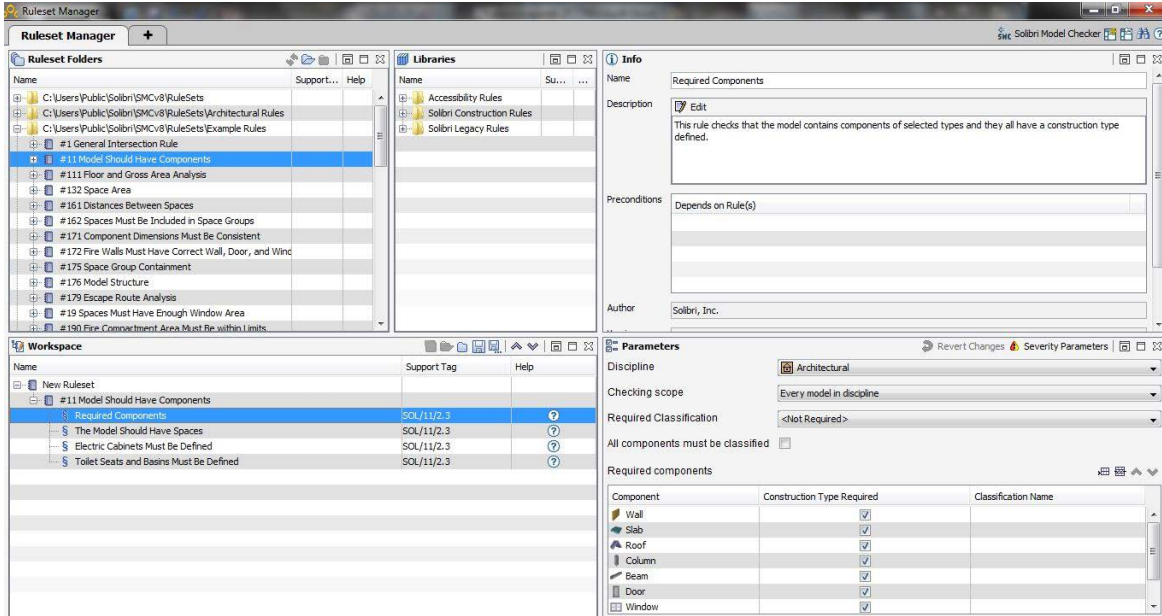

Figure 4.2. Ruleset Manager tool in Solibri Model Checker v8.

If the user is interested in creating totally new rules, they must be custom-made because there is no configurable user friendly language. Software developer staff will help the user to ensure the correct interpretation of the rules and build them into the software. However, nowadays Solibri Inc. has tried to parameterise the rules as much as possible and so there are a lot of built-in rules (Bell, Bjørkhaug and Hjelseth, 2009, p. 14). Every client can create their own rulesets in compliance with their requirements and implement them for several projects, only modifying the parameters. However, all the rules written for SMC cannot readily be adopted in other software as well (Bell, Bjørkhaug and Hjelseth, 2009, p. 14). A client can utilise SMC to visualise the Model using the Model Layout (Figure 4.3).

4. Possible Implementation of BIM in Tendering

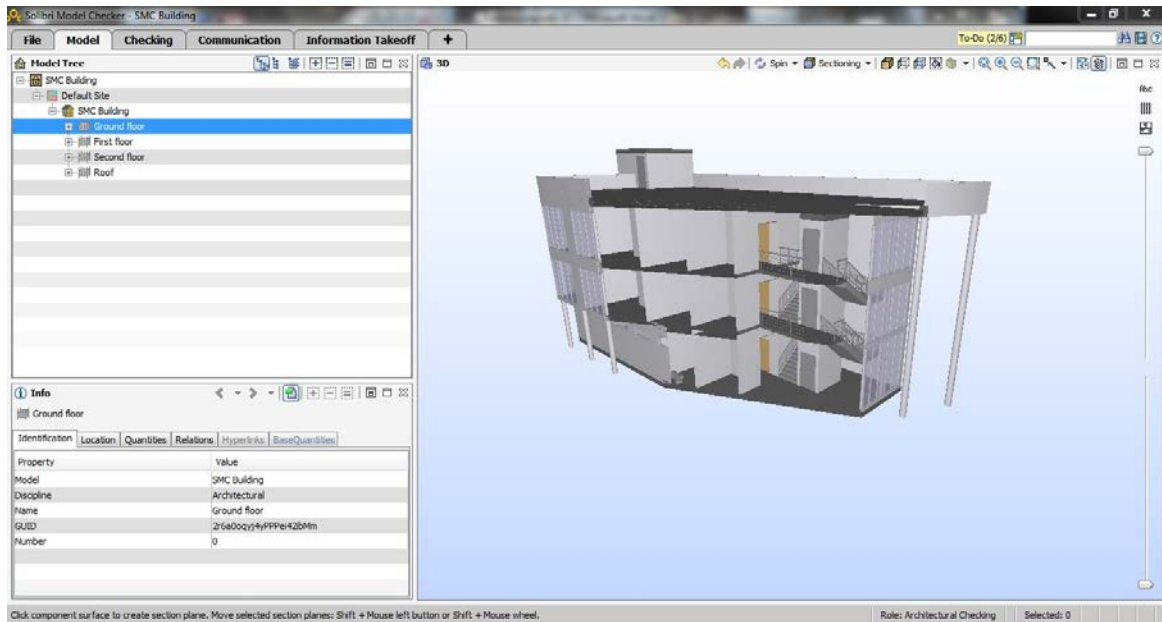

Figure 4.3. Model layout in Solibri Model Checker v8.

The most important layout for a client is of course the Checking one (Figure 4.4), where they can select the rules they would like to be checked and after pressing the 'Check' button they are able to see the conflicts and if necessary to report them in a .pdf or in an .xls sheet. The latter is very useful because it is editable and the jury could insert different weights and points to each issue as a support to the evaluation phase.

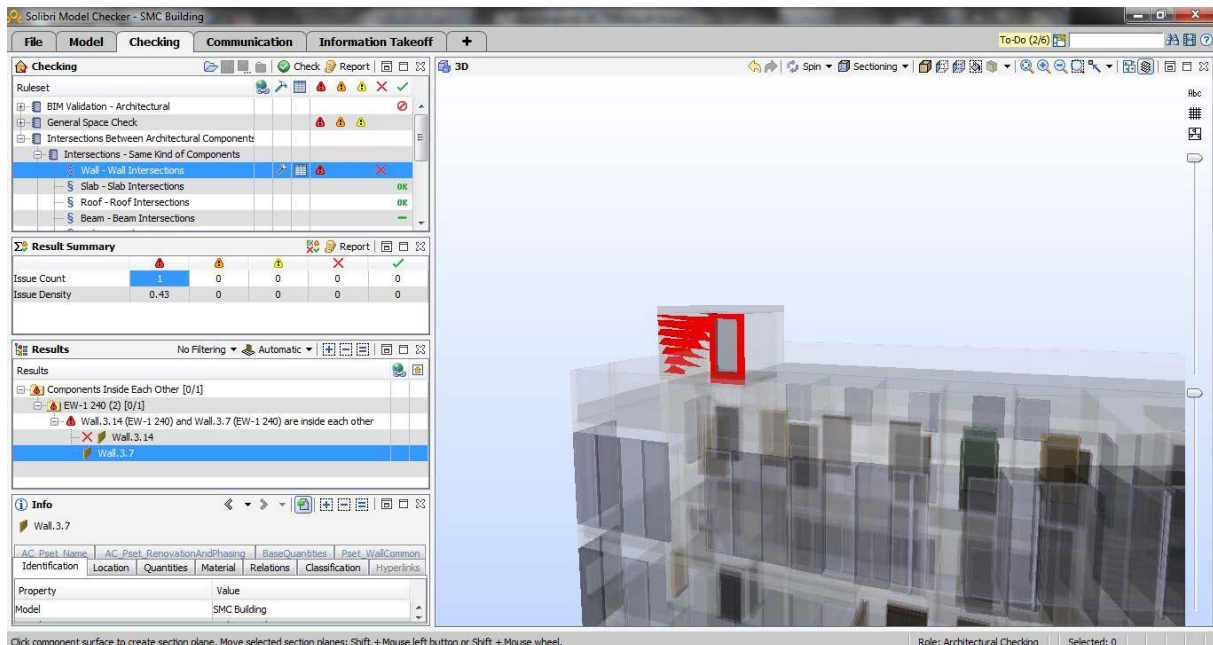

Figure 4.4. Checking layout in Solibri Model Checker v8.

The new version v8.1 also includes an at-a-glance assessment of the quality of the model with a 'Result Summary' view that measures the 'Issue Density' of the model,

and that displays the number of issues with the 'Issue Severity' (Figure 4.5). In SMC there is a specific algorithm that measures the number of issues relative to the volume of the building each Ruleset, sub Ruleset and each Rule has.

Result Summary					
Issue Count	1	4	0	0	0
Issue Density	0.43	1.7	0	0	0

Figure 4.5. Result Summary in Solibri Model Checker v8.1.

More information is available at <http://www.solibri.com> (last visit 21 May 2013).

EDM Model Server

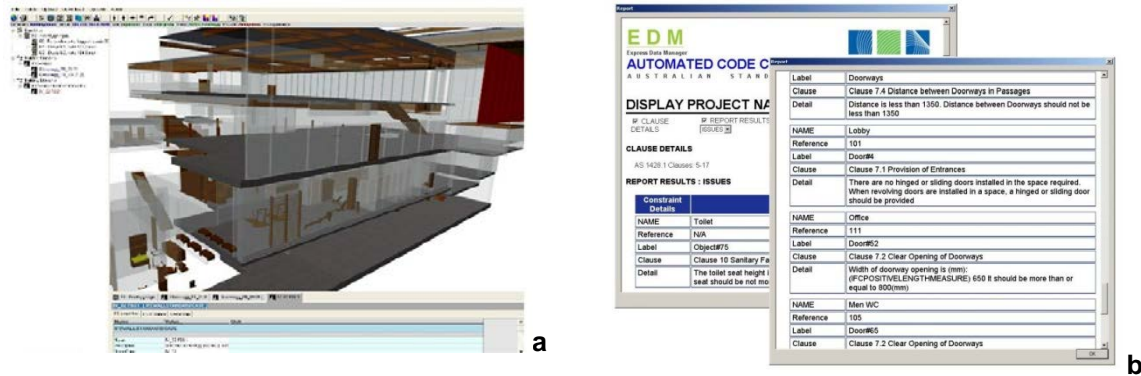

Figure 4.6. (a) Example of EDM Model Server desktop window (Bell, Bjørkhaug and Hjelseth, 2009, p. 15) and (b) Example of EDM Model Server report (Ding, Drogemuller, Jupp, Rosenman and Gero, 2004, p. 11).

EDM Model Server (Figure 4.6) is sold by Jotne EPM Technology and it is a powerful model manipulating tool which is complex to use and requires knowledge of EXPRESS and EXPRESS-X, a standardised object oriented query language. However, it gives the user complete flexibility. Computable rules can be written in EXPRESS-X and compiled and executed directly on EDM Model Server. Rules written in this form can be utilised in any other software which understands EXPRESS-X. Like SMC, the EDM Model Server has a set of built-in rules. To develop new rules, Jotne EPM Technology will help the user in creating the necessary rules, using experts on EXPRESS from Jotne EPM Technology and experts on the original rule sources. EDM Model Server is based on the open international standard EXPRESS, so the data can be imported and exported using open standards. Computable rules expressed in the same standardised language as the IFC model can be executed directly on the EDM Model Server. This gives a powerful and flexible platform, but also a set of tools that require highly skilled professionals to run (Bell, Bjørkhaug and Hjelseth, 2009, pp. 15–16).

More information is available at <http://www.epmtech.jotne.com> (last visit 21 May 2013).

dRofus

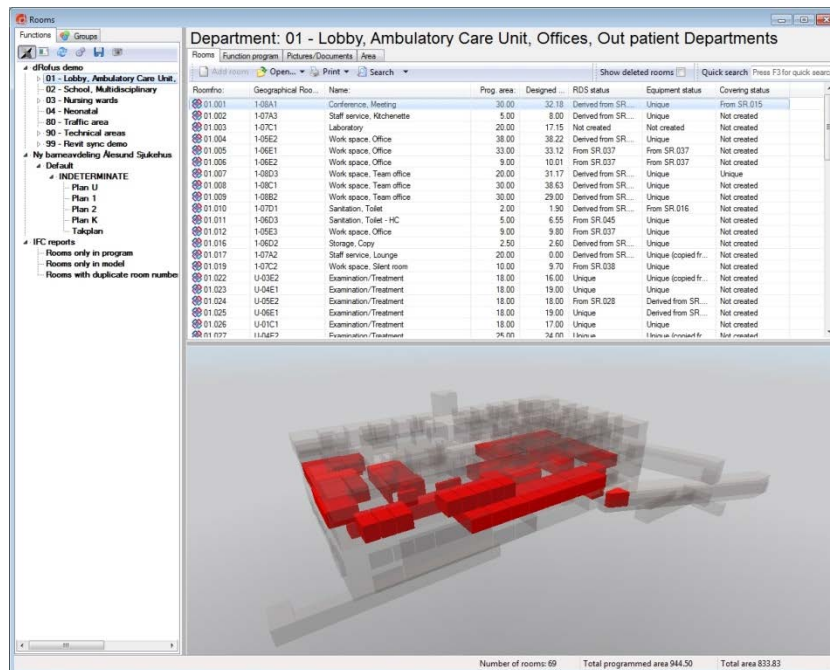

Figure 4.7. Room overview with model connection. Available at <http://www.drofus.no/en/product/modules/room-overview.html> (last visit 2 May 2013).

dRofus is cloud-based software for space planning, programme validation and data management (Khemlani, 2012b) (Figure 4.7). It is possible to attribute different information to each room (e.g. name, description, programmed area, perimeter, height of the false ceiling in a group) using Room Data Sheet (RDS), Room Template or Groups. In addition to the planning and mapping of areas, rooms and functions, dRofus supports the FF&E (Furniture, fixtures and equipment) planning, which allows one to allocate objects with a specific description to the rooms. It is also possible to visualise and check the designed model using the IFC file format (Khemlani, 2012b). Indeed, after the description of the rooms and of the FF&E, the client can adopt dRofus to check the designed model against the programmed requirements using simple rules based on numeric relations between the fields of the RDS and FF&Es (e.g. $>$, $>$, \leq , \geq , $=$ and \neq). Some fields of the RDS and FF&Es are related to each other so it is possible to check if the data included is correct or not.

More information is available at <http://www.drofus.no> (last visit 21 May 2013).

Affinity

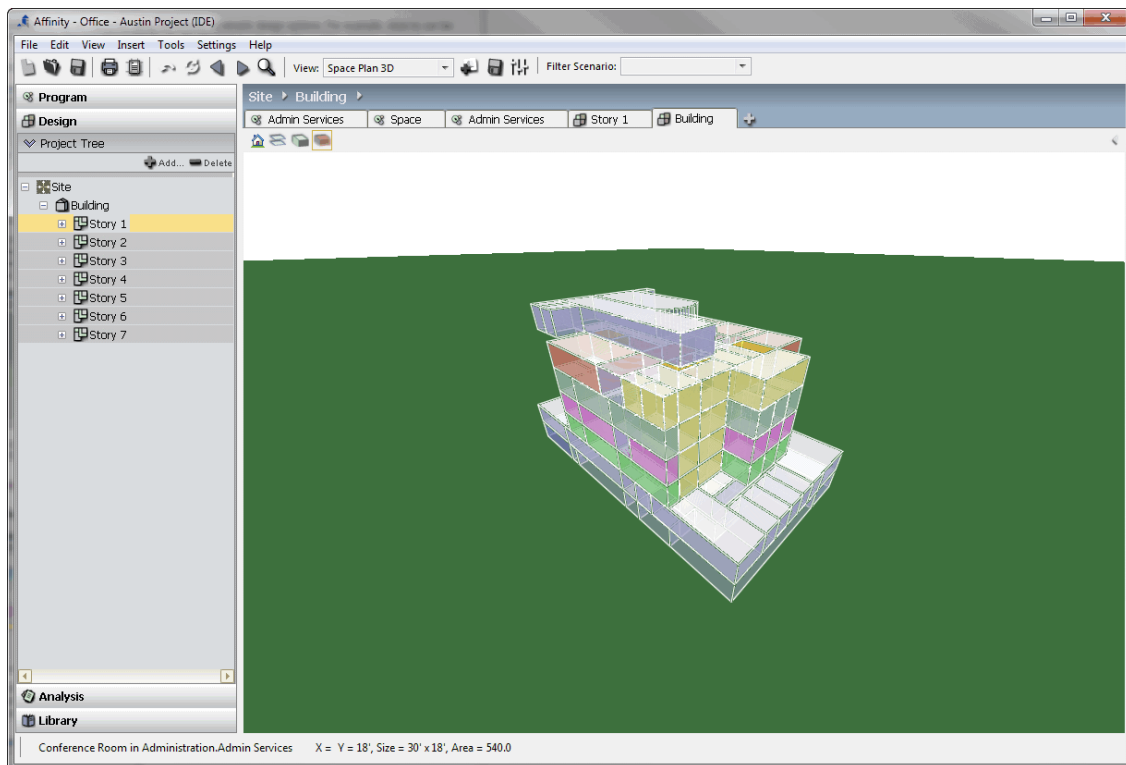

Figure 4.8. Example of Affinity desktop window. Available at http://www.trelligence.com/images/HowWorks_3D.gif (last visit 25 June 2013).

Trelligence Affinity is BIM software for the early architectural design process based on programming, space planning and schematic design solutions (Figure 4.8). It is possible to export the results of the programming phase to more developed design tool such as Revit, ArchiCAD and Bentley AECOsim Building Designer, so the gap between these two consecutive phases is evaded and the information can be implemented. Affinity delivers a comprehensive design validation and analysis tool, built on top of domain-specific knowledge templates. The templates allow the client to easily configure the software to fit different types of building projects ensuring domain knowledge is shared and available to all members of the team. Affinity is also useful for early-stage estimating, for assisting with go/no-go assessments, and for early sustainability analysis. It is possible to set specific requirements and as the design progresses, Affinity provides ongoing analysis of the design's compliance to the program requirements, alerting the designer to program violations, and enabling the design team to make informed decisions and reducing later rework and helping to deliver designs that meet the client's requirements. Reports can be generated in pdf, excel and word and Affinity files can be exported in several format such as DXF (suitable for CAD software) and IFC 2x3 (for BIM programs). A client could prepare a template for a specific tender, including requirements such as number and dimension of spaces, properties and relations between objects, and provide it to tenderers to prepare their proposal. For this reason this tool can be a useful support also in the tender phase.

More information is available at <http://www.trelligence.com> (last visit 25 June 2013).

4. Possible Implementation of BIM in Tendering

dProfiler

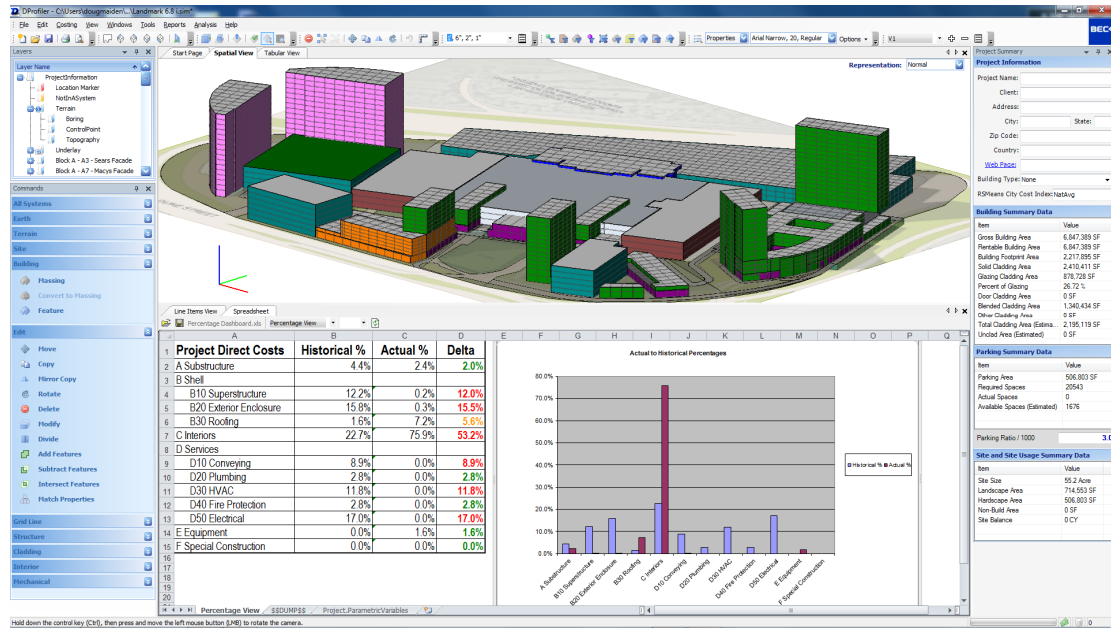

Figure 4.9. Example of dProfiler desktop window. Available at http://beck-technology.com/assets/dp06_mixed-use.png (last visit 25 June 2013).

dProfiler is a Beck Technology software for the early design phase to facilitate rapid model creation and real-time analysis across several disciplines (Figure 4.9). It allows cost estimation because there is a customisable database to define costs of objects and materials. Moreover, energy analyses can be carried out to analyse the impact of a facility in the surrounding area. It is also possible to create a scheduling and simulate the construction phase. Finally, it is a valid support to analyse alternatives. For this reason the jury could use this tool to evaluate different proposal and compare them and the bidders could adopt it to define their bid finding better solutions.

More information is available at <http://beck-technology.com/dprofiler.html> (last visit 25 June 2013).

Autodesk NavisWorks

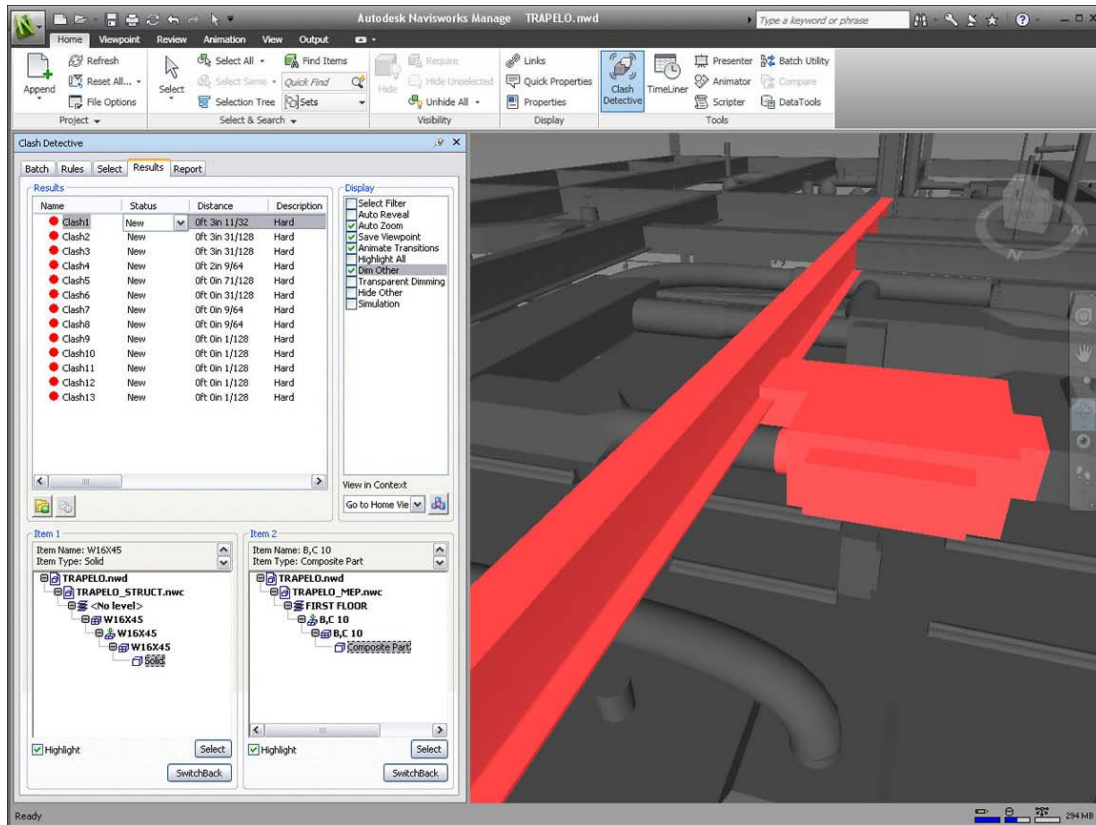

Figure 4.10. Clash detection between two sets of elements in Autodesk Navisworks. Available at <http://www.autodesk.com/products/autodesk-navisworks-family/features> (last visit 2 May 2013).

Autodesk NavisWorks is a 3D application for model aggregation, coordination, real time visualisation, construction simulation and project analysis for integrated project review (Figure 4.10). Moreover, there are tools to simulate and optimize scheduling, identify and coordinate clashes and interferences. The application is very useful to import different 3D design file formats and combine multiple models into one file, with an effective compression technology that allows them to be reviewed easily as a whole project, reducing the overall file size (compress individual models up to 70% of their original size). Essentially, it is useful for any project that has large 3D data sets. It can also be gainfully used within a single discipline. NavisWorks can support the open standards IFC file format, in addition to the traditional ones. It is possible to get a whole project view and a Selection Tree automatically provides a hierarchical listing of the model components, making it easy to select and view different parts of the model. It is also possible to avatar navigate through the model, providing a third person view and a sense of scale. This would be useful to a client for better understanding of the final proposals. NavisWorks can create also photorealistic visualisation and there are a set of tools for measuring distances, areas, and angles in the model. Moreover, views can be saved and it is possible to mark up models and add comments and other redline marks. Later it is possible to export a viewpoints report in HTML format, showing a screenshot of the tagged item and any associated comments. NavisWorks allows 4D

construction simulation works by linking the Building Information Model with a construction schedule, which can be brought in from project scheduling applications such as Primavera P6 and Microsoft Project. This tool is very useful for the steps after the awarding phase but it can also give an overall idea of the time schedule in the tender phase if requested. The software also includes an interference checking and clash detection tool, which enables effective identification, inspection, and reporting of interferences (clashes) in a 3D project model. It works by 'selecting the elements or element groups that are to be checked against each other, specifying a tolerance value, and setting options for clash type and interference method, after which the clash test can be run' (Khemplani, 2008). The results window lists all the detected clashes, and allows each instance to be investigated more closely in the graphics window. Clashes can be set to a different status depending on whether they are new, active, reviewed, approved, or resolved. If some clashes require changes, they must be made in the original authoring tools because NavisWorks does not include any object editing capabilities to fix them as SMC. It is also possible to export the clash results as viewpoints with comments attached containing the clash result details. The Clash Detective tool conducts clash tests between traditional 3D geometry and, even if it is possible to create customised rules, they are less flexible than those in SMC and they are focused on geometrical clash detection.

More information is available at <http://www.autodesk.com/products/autodesk-navisworks-family/overview> (last visit 21 May 2013).

Tekla BIMsight

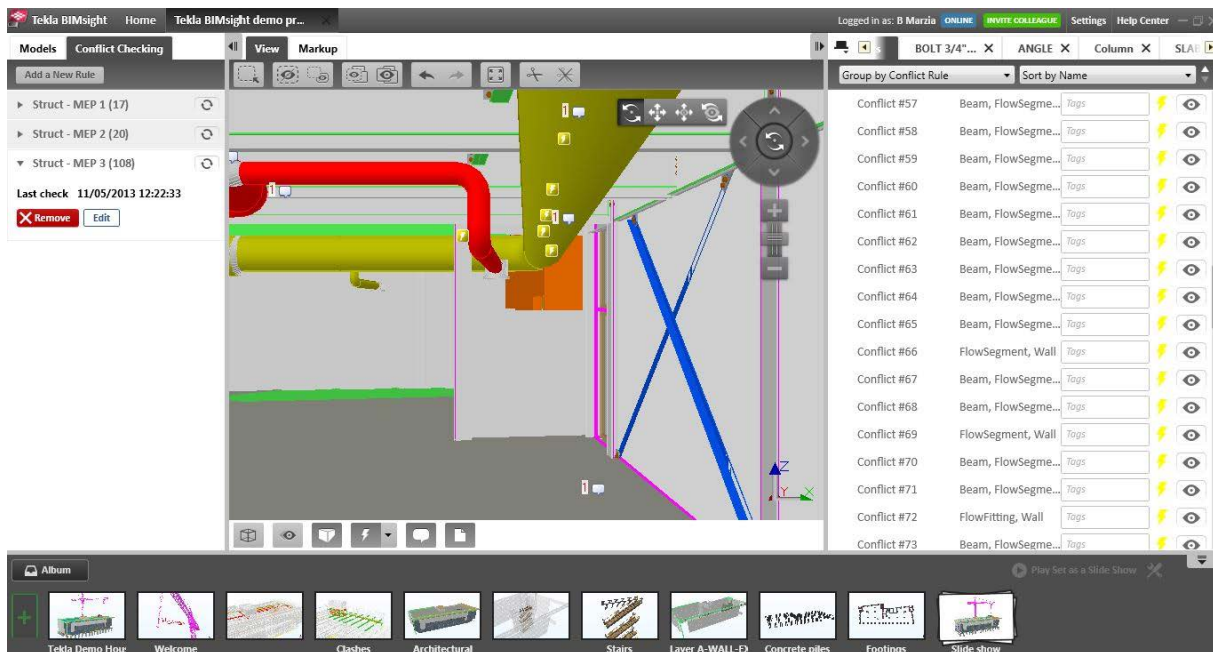

Figure 4.11. Example of Tekla BIMsight desktop window.

Tekla BIMsight is a free software by Tekla, which allows to combine models, clash detection, visualisation and communication between different parts (Figure 4.11). It supports IFC file format and it is very useful for visualisation purposes because both clients and bidders can utilise it to navigate in the Building Information Model, understand its

complexity and measure objects. It is possible to check models using a Conflict Checking tool. However, also in this case, the check is a geometrical one, as in NavisWorks, and it is not based on rulesets, even if it is possible to set some parameters and the tolerance. Tekla BIMsight allows marking up, adding comments or linking documents to facilitate communication in the process. Even if it is not powerful software for evaluating the compliance between client's requirements and the bids, because it is not possible to set a specific ruleset, which covers not only geometrical aspects, it can still be used in public tenders to analyse the quality and visualise the Building Information Model. Thanks to its free availability and to the compatibility with open standards such as the IFC format, Tekla BIMsight can be a useful support in the tender phase of public works. More information is available at <http://www.teklabimsight.com> (last visit 21 May 2013).

Bentley Projectwise Navigator

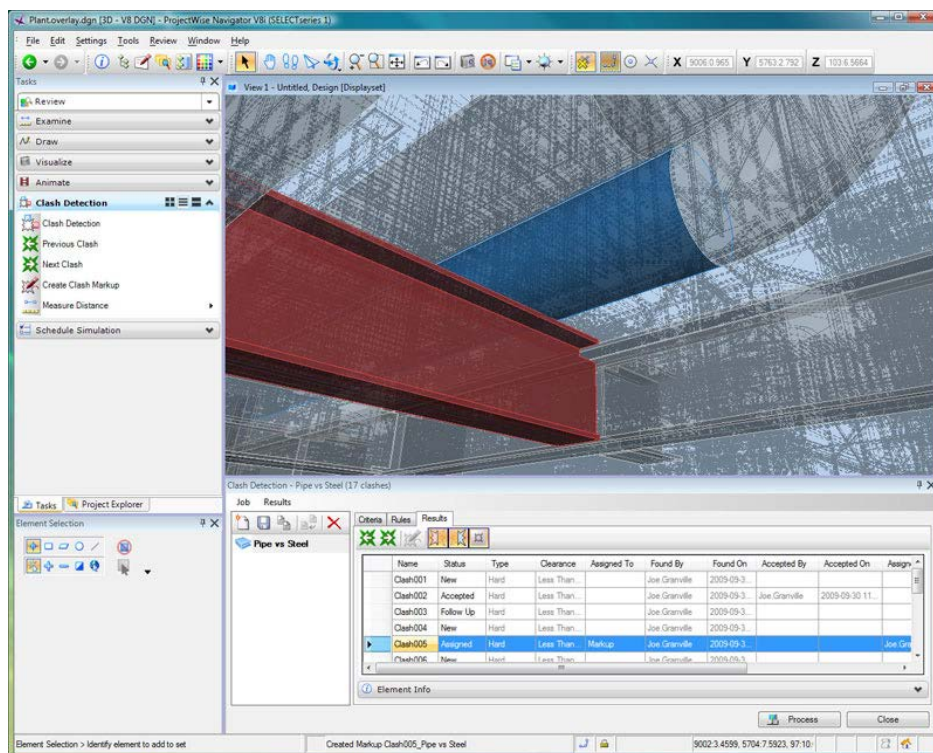

Figure 4.12. Example of detect and resolve clashes tool in Bentley Projectwise Navigator. Available at <http://www.bentley.com/NR/rdonlyres/A12EE3B3-4347-4E19-A6B4-7F049A0D08D8/0/nav03.jpg> (last visit 11 May 2013).

Bentley Navigator is a software programme by Bentley used to review and analyse project information virtually by detecting and resolving clashes and simulating project schedules (Figure 4.12). Bentley Navigator is similar to NavisWorks and allows the visualisation of BIM, the possibility to mark up models and add comments. It supports open standards such as IFC format and it allows detecting clashes on native content, managing and resolving clash results effectively. Also in this case, the checking tool is focused on geometrical clashes as in Navisworks and in Tekla BIMsight, so the client cannot set rulesets themselves. However, it is possible to import project schedule information to simulate project planning and generate photorealistic rendering.

More information is available at <http://www.bentley.com> (last visit 21 May 2013).

Nowadays there are lots of commercial software products for Energy Analyses, such as Transys and EnergyPlus (by DesignBuilder). The U.S. Energy Department set a list of the main Building energy software tools, available at http://apps1.eere.energy.gov/buildings/tools_directory/alpha_list.cfm (last visit 11 May 2013). Only Riuska and Autodesk Ecotect are described below because they have been used in some of the case studies in paragraph 4.5.

Riuska

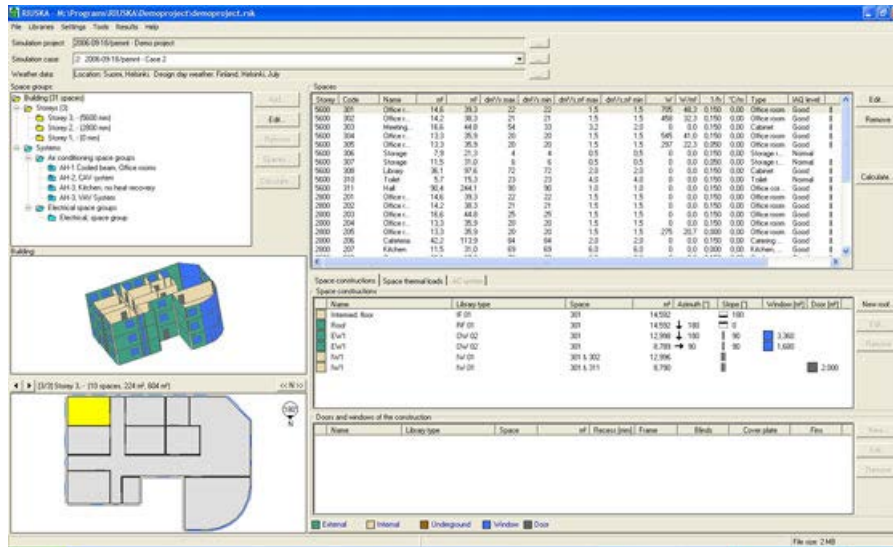

Figure 4.13. Example of Riuska desktop window. Available at http://apps1.eere.energy.gov/buildings/tools_directory/screenshots.cfm/ID=239/pagename_submenu=/pagename_menu=/pagename=alpha_list_sub (last visit 11 May 2013).

Riuska is a Finnish integrated simulation systems programme by Olof Granlund Oy for building services design and facilities management (Figure 4.13). It can be used in everyday design processes and covers the thermal simulation needs of the whole building life cycle. It is possible to add building envelope materials, internal loads, and HVAC into the created 3D model and perform thermal calculations. Moreover, Riuska can be used for space simulations to dimension cooling or heating equipment, or for energy calculations of the whole building. It supports IFC file format so 3D models must be created in some IFC-compliant 3D modelling tool.

More information is available at <http://www.granlund.fi/en/software/riuska> (last visit 21 May 2013).

Autodesk Ecotect

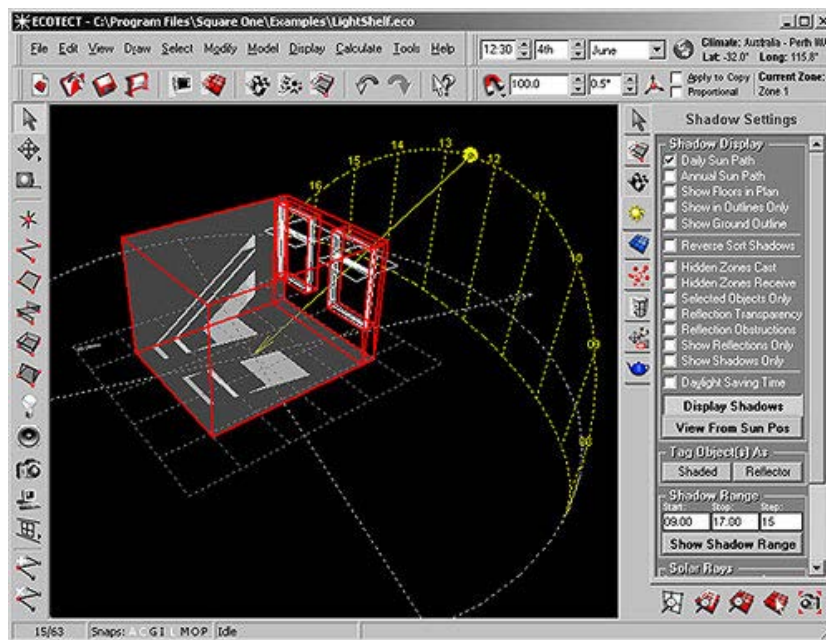

Figure 4.14. Example of Autodesk Ecotect desktop window. Available at http://apps1.eere.energy.gov/buildings/tools_directory/screenshots.cfm/ID=391/pagename_submenu=/pagename_menu=/pagename=alpha_list_sub (last visit 11 May 2013).

Autodesk Ecotect is a programme by Autodesk with extensive solar, thermal, lighting, acoustic and cost analysis functions (Figure 4.14). In Autodesk Ecotect the performance analysis is simple, accurate and effective. It can calculate the total energy consumption and carbon emissions of a building model on an annual, monthly, daily, and hourly basis, using a global database of weather information. It is possible to check the thermal performance calculating heating and cooling loads and analysing effects of occupancy, internal gains, infiltration, and equipment. Moreover, the client can check the water usage inside and outside the building and the cost evaluation. Autodesk Ecotect allows to visualise the incident solar radiation on windows and surfaces over any period and to calculate daylight factors and illuminance levels. Finally, shadows and reflections can be analysed by displaying the sun's position and path relative to the model at any date, time, and location. This tool can be used for checking if some energy requirements in the tender documents have been respected even if there are some problems in the import of IFC file formats.

More information is available at <http://usa.autodesk.com/ecotect-analysis> (last visit 21 May 2013).

There are several commercial cost estimation software programmes available in the market and their popularity depends on geographical locations. Only EasyBIM, Vico Cost Planner and Mitchell Brandtman are presented below.

EasyBIM

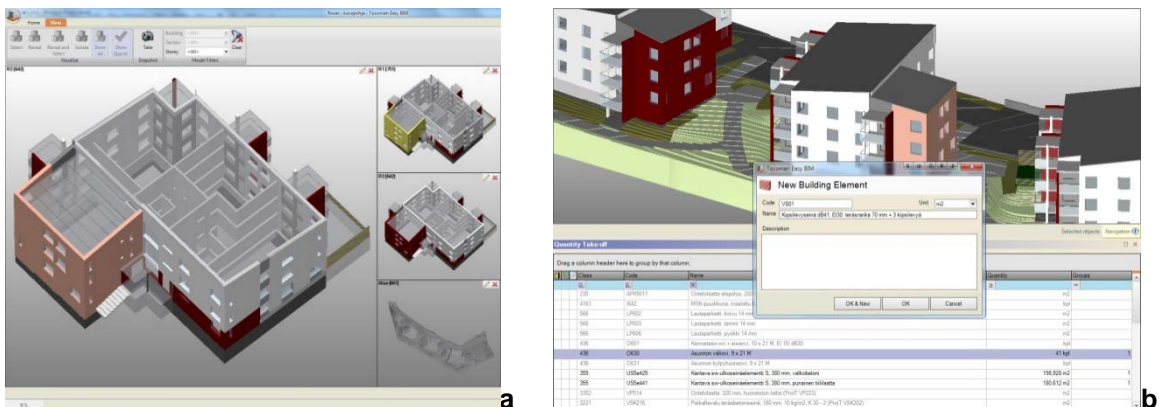

Figure 4.15. (a) Example of division of the project into locations using EasyBIM and (b) Example of creation of a new element for the QTO tool in EasyBIM.

The Tocoman company has developed EasyBIM, a BIM-oriented construction planning and management software for quantity take off (QTO), cost estimating, procurement and construction scheduling. It opens only IFC files and allows the visualisation of the project in a 3D window, showing the different components selected and their properties. It generates QTO from 3D models but also from 2D drawings, because usually models do not contain all the information needed. If contractors prefer to divide the quantities by location, which are not always the ones set by the designers, they can adopt EasyBIM to create their own division (Figure 4.15a). Moreover, they can subdivide the project in sections (e.g. separating the construction site, the first building, the second and the third), in this way the contractor can organise the work better. The QTO tool of EasyBIM is more powerful and accurate than the ones in some modelling software (e.g. Revit or ArchiCAD), because it allows one to control the process and to set codes, names and units of measurement (Figure 4.15b). If the project changes, the software uploads the quantities to get new QTO. After that, a login is necessary to open the recipes, in this way the user has more guarantees regarding the content of recipes. Thanks to Tocoman Express, it is possible to load default recipes and match the quantities to them. The recipes are 'intelligent' because they take into account the building elements in their entirety, calculating the components and resources needed to build them. If required, the user can change and customise the recipes. Moreover, EasyBIM gives support in the production planning and scheduling activities. This software can be used by the client to have an idea of the total price of a project and also by the contractors to prepare more accurate bids. EasyBIM does not support specific model checking tools to control the quality of the model and to fix it. It only gives the possibility to check models visually. For this reason the models must be good enough to be used in this software to generate reliable results. Today it is available only for the Finnish, Swedish, Norwegian, Danish and Russian markets, but in the near future it will be ready for other countries. EasyBIM will replace the actual Tocoman software made up of Tocoman iLink and Tocoman Express, which does not directly support IFC standards.

More information is available at <http://www.tocoman.com> (last visit 21 May 2013).

Vico Cost Planner

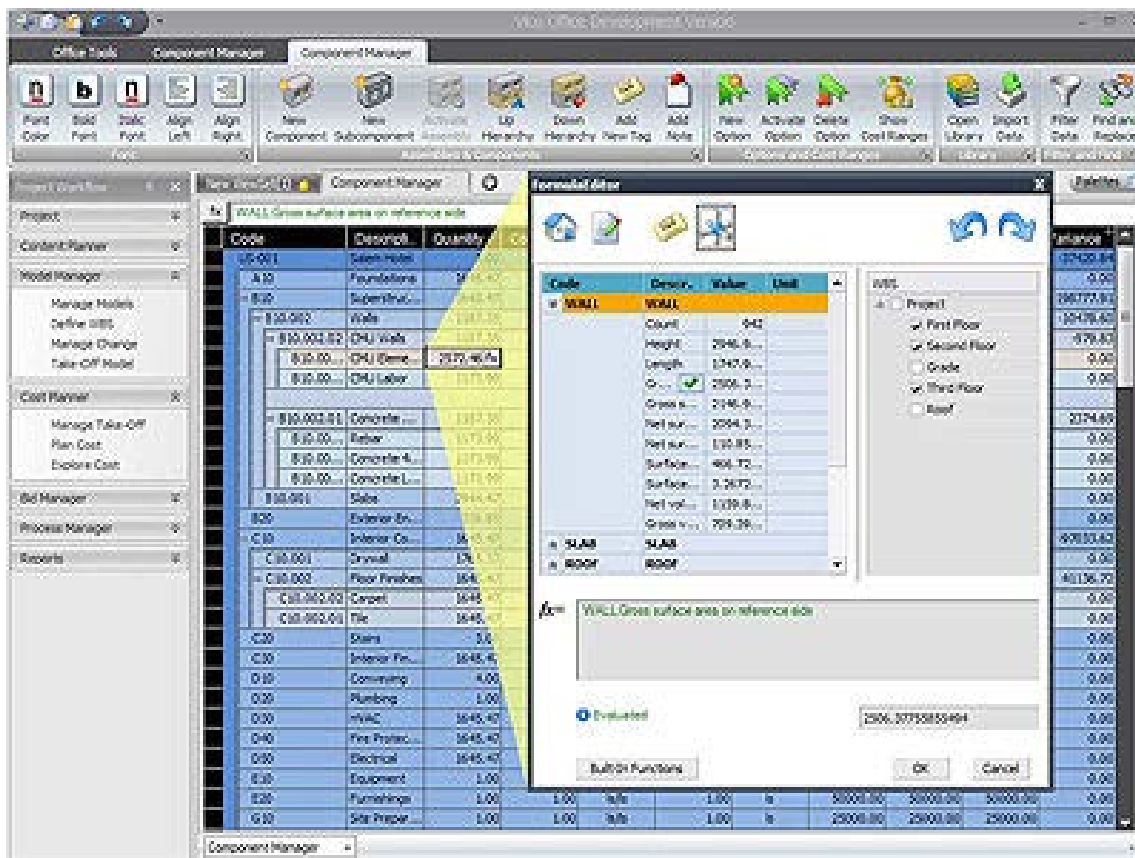

Figure 4.16. Example of Vico Cost Planner desktop window. Available at <http://www.vico software.com/products/vico-office-cost-planner/tabid/85288/Default.aspx> (last visit 11 May 2013).

Vico Cost Planner is the cost calculation, estimating, and value engineering module in the Vico Office Suite (Figure 4.16). It leverages the model based quantities taken by the Vico Takeoff Manager and provides highly accurate estimations. Cost Planner enables continuous cost feedback throughout all project phases from a basic abstract level to a highly-detailed cost estimate. It includes a Library Manager, which allows the utilisation of one's own historical data and store a collection of standards and reusable estimating content. Moreover, using the Formula Editor it is possible to gain control over the way quantities are used for cost calculation. The Formula Editor leverages the quantity data collected with Vico Takeoff Manager and allows to define conditions, combine quantities, filter locations, and refine the calculation to provide input for the Assembly-Component structure. The software allows to select a Cost Component and highlight its related element in the 3D View and effectively communicate its cost structure. Finally, it is possible to assign Cost Types to Components and define specific markup percentages for each Cost Type to get a detailed project bid price.

More information is available at <http://www.vicosoftware.com> (last visit 21 May 2013).

Mitchell Brandtman

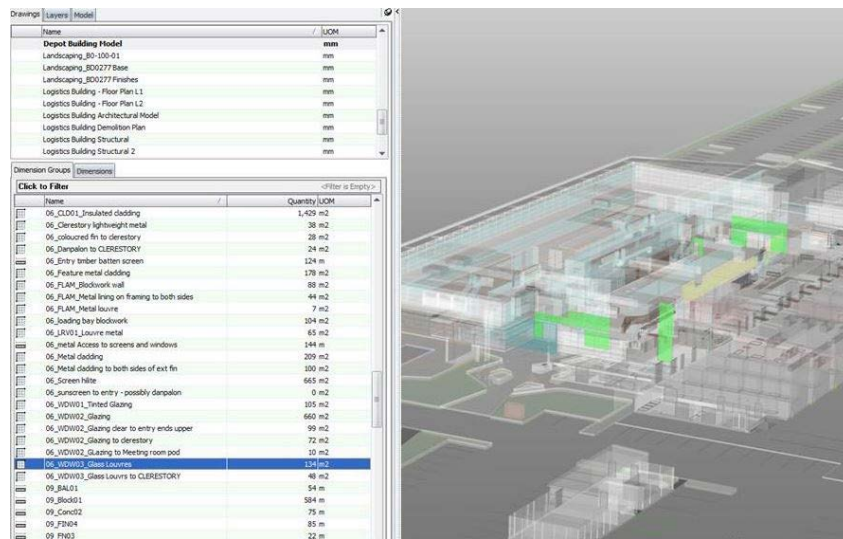

Figure 4.17. Example of CostX desktop window. Available at http://www.mitbrand.com/assets/documents/PDF/5D_Cost_Planning_MitchellBrandtman_19-04-2013.pdf (last visit 24 August 2013).

Mitchell Brandtman is an Australian company which provides quantity surveying and construction risk management services. It supports 5D cost planning and estimation from models. 5D Cost Planning services provide realistic and precise cost estimates at any stage even from preliminary designs to the construction and beyond. It is possible to accurately calculate quantities and create dynamic links between BIM software, such as Revit, and IFC model information, rate libraries and estimate templates. The dynamic links mean that estimates can be recalculated quickly every time the model information is revised. The software adopted, CostX by Exactal (Figure 4.17), has a 3D window to visualise the model and select components. It is possible to check properties and extract quantities useful for the cost planning.

More information is available <http://www.mitbrand.com/info/home/> (last visit 24 August 2013).

4.4.3 Checking from a BIM the Client’s evaluation criteria and requirements

As already discussed in the previous paragraph, the client is able to check the compliance between the content of the bids and their requirements only if the BIM requirements, included in the tender documentation, are clear and complete and if the bidders follow them to prepare the model. The client will be able to control only the information which has been included beforehand by the bidders. Model checking tools can analyse the content of the model but they cannot generate new data (e.g. if the client would like to check the dimension of a specific space, an office for example, the model must contain the space ‘office’, otherwise the tool cannot find the space to be measured).

Below is a list of the most common operations, which a client could check nowadays in a BIM tender and the main commercial software available. More emphasis is given to the software Solibri Model Checker (SMC), because the study was mostly carried out using this specific software.

Operations and commercial software		
A	Quality of the model	e.g. SMC, Autodesk NavisWorks, Tekla BIMsight, Bentley Projectwise Navigator
B	Check the anonymity of the BIM file	e.g. SMC
C	Naming programme	e.g. SMC
D	Space requirements	e.g. SMC, dRofus, Affinity
	Area and Volume quantities measurements	e.g. SMC
	Presence of Equipment/Furniture	e.g. SMC, dRofus, Affinity
E	Properties of elements	e.g. SMC
F	Energy analysis	e.g. Riuska, Autodesk Ecotect
G	Cost calculation	e.g. EasyBIM, Vico Cost Planner, Mitchell Brandtman, dProfiler
H	Accessibility	e.g. SMC
I	Safety and Security	e.g. SMC

A. Quality of the model

First of all the client is interested to assess if the overall quality of the model is adequate and if there are geometrical errors due to inability to adopt BIM software to generate the models. Nowadays many programmes are available for the clash detection because the research of geometrical conflicts was the first to be developed and professionals in the AEC industry usually utilise it to assess model quality (Hjelseth, 2012). In SMC for example, it is possible to find intersections (or overlapping) between the same components (e.g. walls against walls) or different ones (e.g. walls against doors) or between furniture and other objects (Figure 4.18).

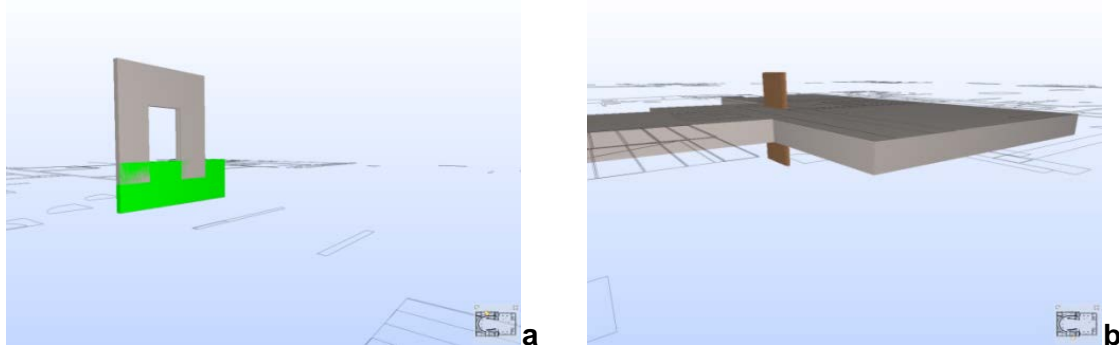

Figure 4.18. (a) Intersection of walls in Solibri Model Checker v8 and (b) Intersection between a door and a slab in Solibri Model Checker v8.

It is also possible to check if components touch other components (e.g. columns must touch components above/below them) and if there is enough free area in front of components (e.g. clearance in front of windows or doors). The client can also control the

model structure using the Model Tree view (e.g. to see if the division in floors is respected) (Figure 4.19), in addition, there are rulesets which check that the model includes a building and building floors, that all components are contained by a building floor and that there are no empty floors.

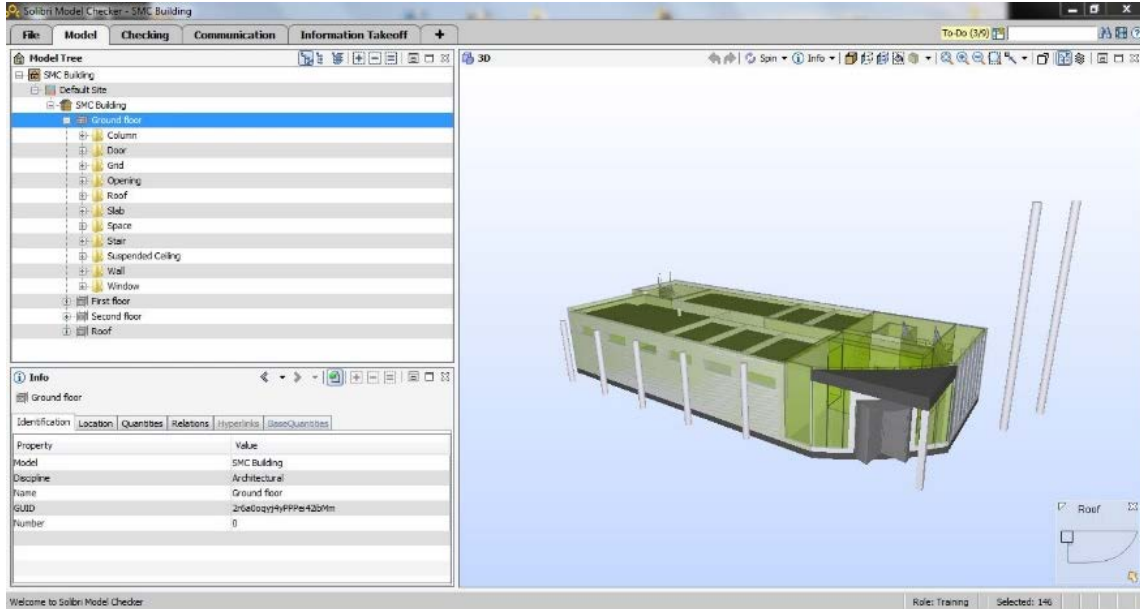

Figure 4.19. Model Tree View in Solibri Model Checker v8.

If the models contain both architectural and structural models a rule can check if components in a structural model fit inside the components of an architectural one and vice versa. It is possible to validate also the building envelope thanks to a rule which checks that external walls defined in the model are the same as walls surrounding gross area spaces and/or all spaces in the model. Moreover, if components of the same construction type in the whole building model or on a specific floor must have the same selected dimensions, a rule can control it (e.g. thickness of walls, slabs or roofs, the top elevation of doors and windows, height of walls and columns located in the same floor). Finally, the client can control the location of the origin of the model using the newest version of SMC v8.1 (Figure 4.20).

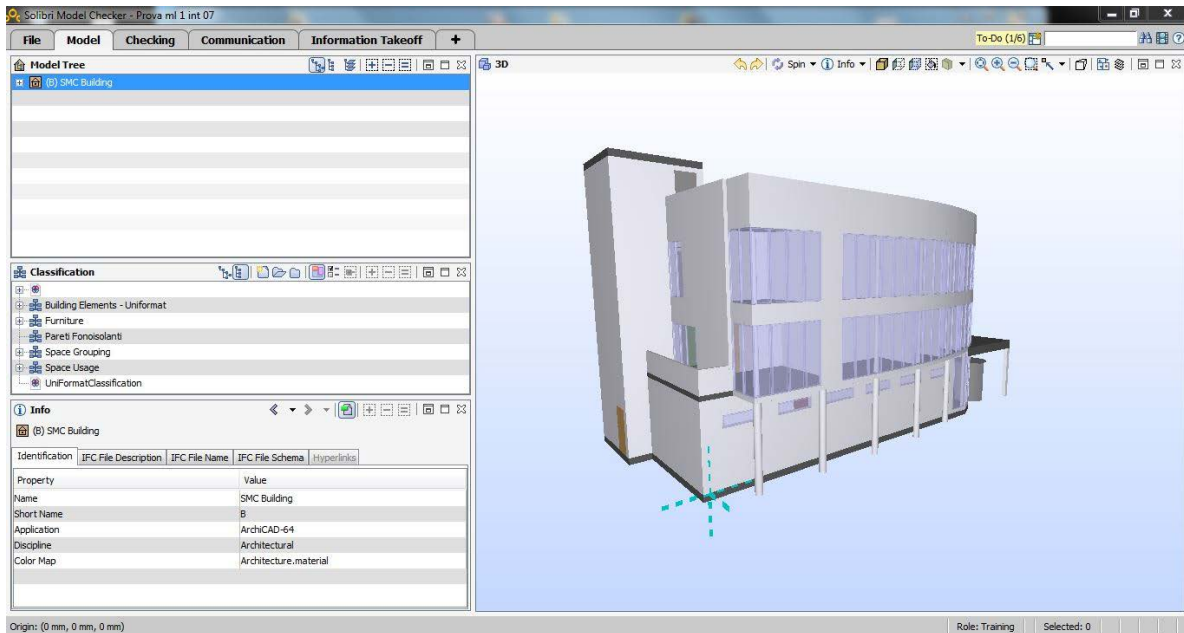

Figure 4.20. Visual check of the location of the model origin in Solibri Model Checker v8.1.

B. Check the anonymity of the BIM file

If there are tenders where the anonymity of the final submission of IFC files is required, SMC can check it not automatically, but by using the Model Layout and control if in the 'Info' window, the field 'Author' in the 'IFC File Name' is present or not (Figure 4.21).



Figure 4.21. Info window of the Model layout in Solibri Model Checker v8.

C. Naming programme

The client usually indicates how to give a name to components and spaces of the Building Information Model. Thanks to SMC it is possible to check if the names system follows the agreed list. In addition, if the floors names must be numeric and consecutive, there is a rule to check it. The client can also verify if the BIM file names conform to a specific naming scheme (Figure 4.22).

4. Possible Implementation of BIM in Tendering

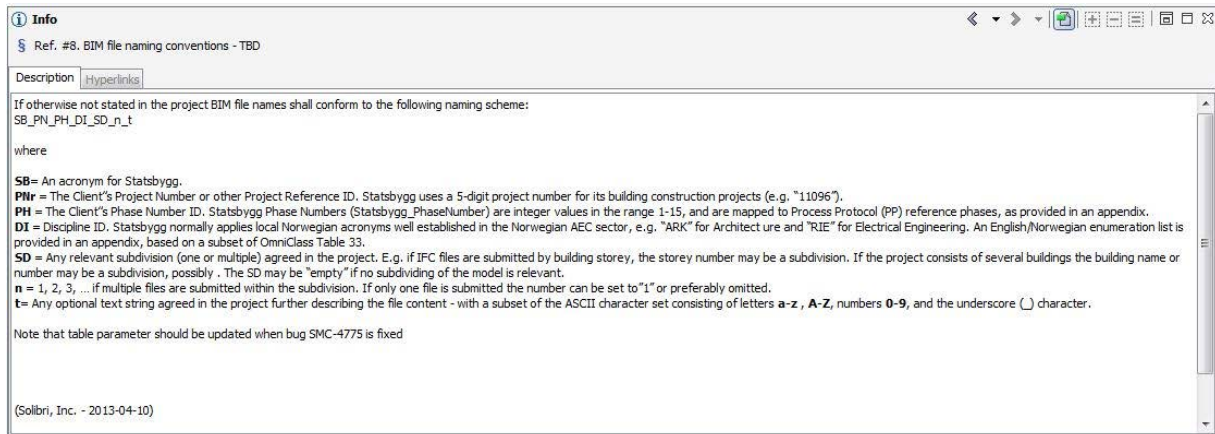

Figure 4.22. Example of BIM file naming convention rule in Solibri Model Checker v8.1.

D. Space requirements

In the tender documents it is possible to find several prescriptions related to spaces. First of all SCM can check if there is a given number of Spaces with a given space type and area (e.g. 10 office spaces with an area between 9 and 11 m²) in the entire model or in a specific floor. It is possible to control also the accuracy of their geometry and location and if they have been modelled in the correct way. The client can verify the height of spaces and there is also a rule which checks that distances between specified start and destination spaces follow a given distance requirements (maximum and minimum distances) (Figure 4.23).

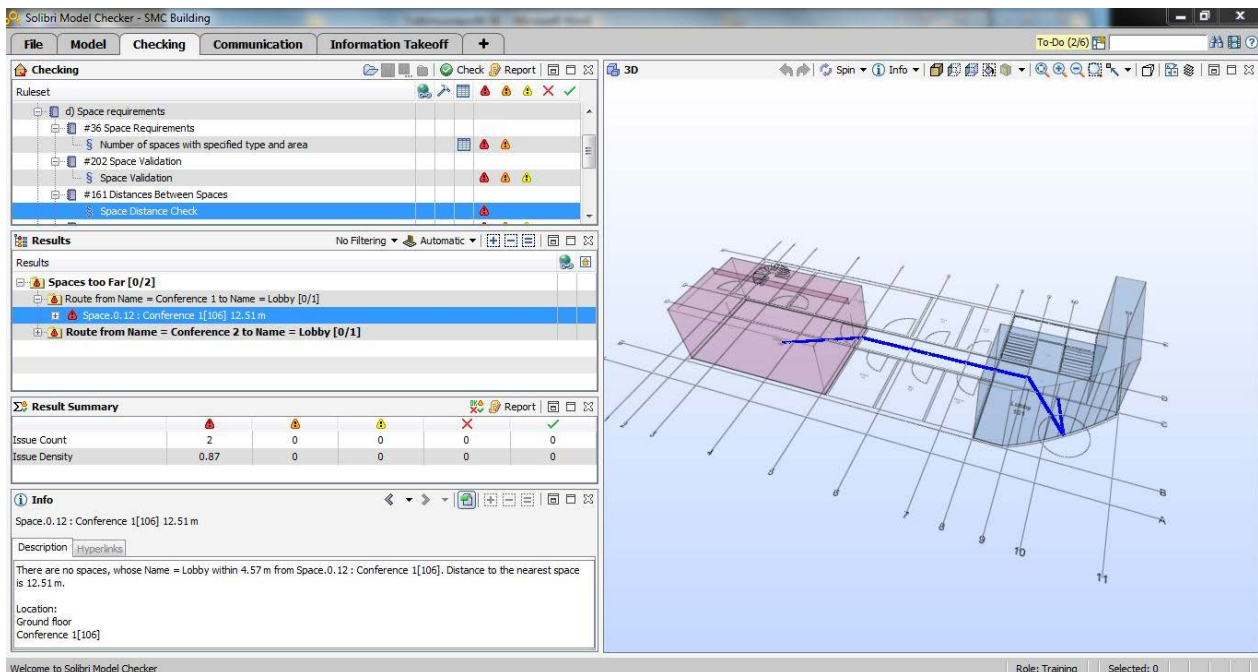

Figure 4.23. Example of Space Distance Check rule in Solibri Model Checker v8.1.

If the BIM requirement indicates a Space group, the inclusion of some spaces in groups can be checked. Moreover, there is a rule which checks that all space groups, which contain spaces, have the required number of spaces with the required specified types. Usually each space requires a specific value of window area, for this reason in SMC a rule controls that each space has a window area which is relative to its floor area and within specified range.

Area and Volume quantities measurements:

Usually the client specifies the total or sub-parts of the area or volume of the building in the tender documentation and then they want to check if the bids follow their indications. Using the Information takeoff tool it is possible to calculate quantities such as areas or volumes of specific spaces and check it manually. Instead it is possible to check automatically if given areas of spaces or the total area of spaces on each building floor are within specified minimum and maximum area limits (Figure 4.24).

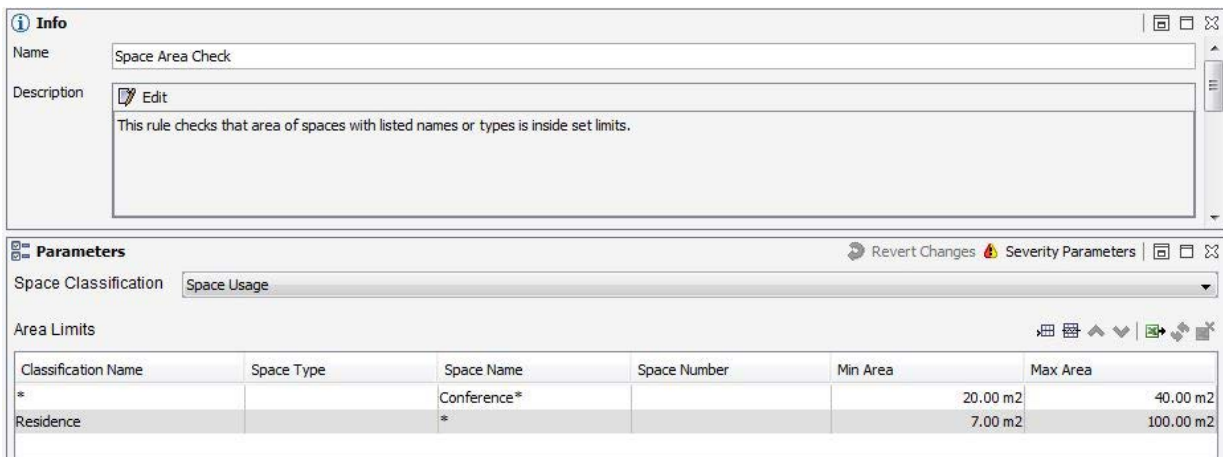

Figure 4.24. Example of Space Area Check rule in Solibri Model Checker v8.1.

Presence of Equipment/Furniture:

Both dRofus and SMC can be used to control if a particular equipment/furniture exists or not in BIM. For example in SMC it is possible to check if a number of components are included in a space (e.g. if there are toilet seats and basins in toilet spaces) (Figure 4.25).

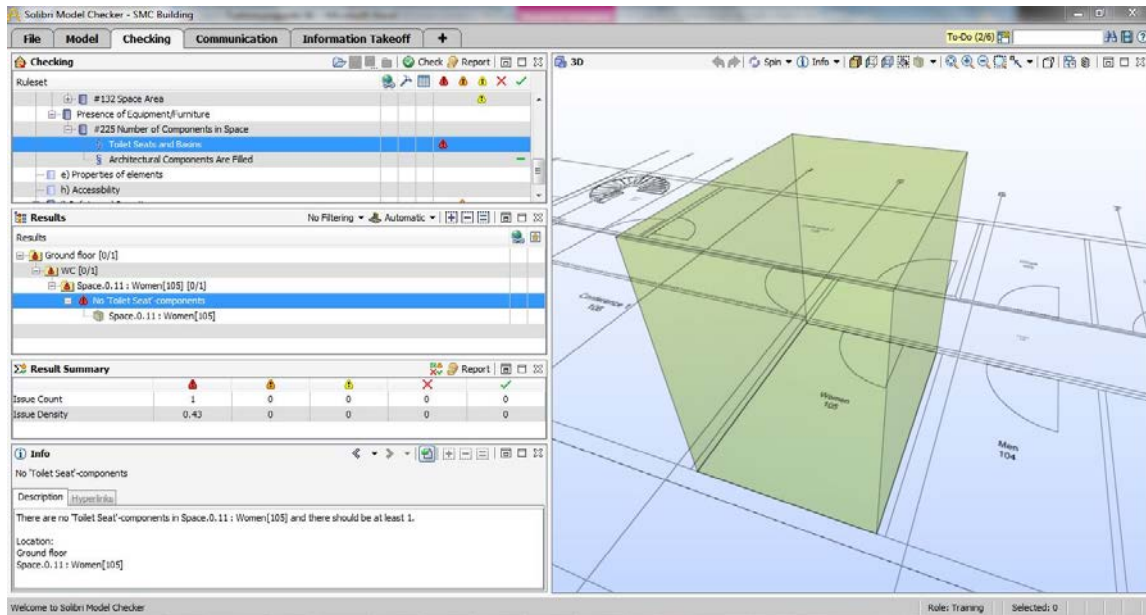

Figure 4.25. Example of rule to check the presence of components in spaces in Solibri Model Checker v8.1.

E. Properties of the elements

BIM is not only a simple 3D model but it contains a rich database from which it is possible to extract all kinds of information. SMC checks (and creates issues accordingly) that the model contains the required property sets and properties. It can also check that the properties have (or don't have) a value and if the type of the value is acceptable. Issues are created in case of missing values, unaccepted values and wrong values when values are required by the property. Example of properties can be material, type, ID, name, location, geometry (e.g. area, gross area, height, length, thickness, volume), classification, possible relations with other elements (e.g. if a wall touch other walls and/or if it delimits a space, if the distance between floors or between walls is enough or too much). The bidders can add specific values to elements of several disciplines for example the efficiency of heating exchanges, the quantity of lux in a lamp, the acoustic isolation value of walls, the carbon emission of each component, the colour of walls. Later the client can analyse if the values are correct in a very simple way using appropriate rulesets (e.g. to control if values such as the efficiency of heating exchanges are in compliance with their requirements) (Figure 4.26).

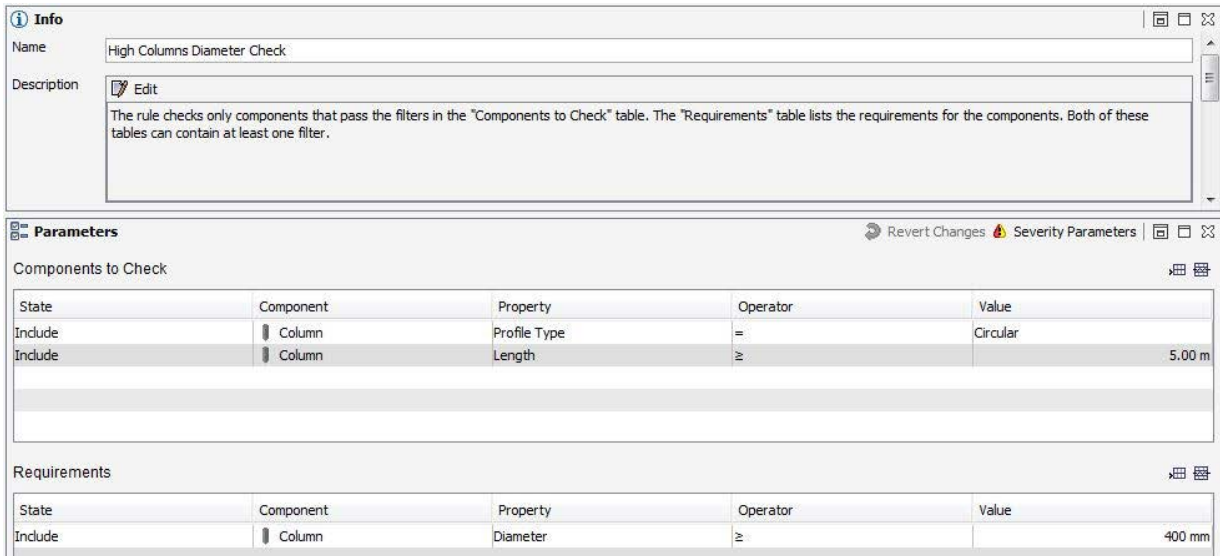

Figure 4.26. Example of rule for checking properties of elements in Solibri Model Checker v8.

F. Energy analysis

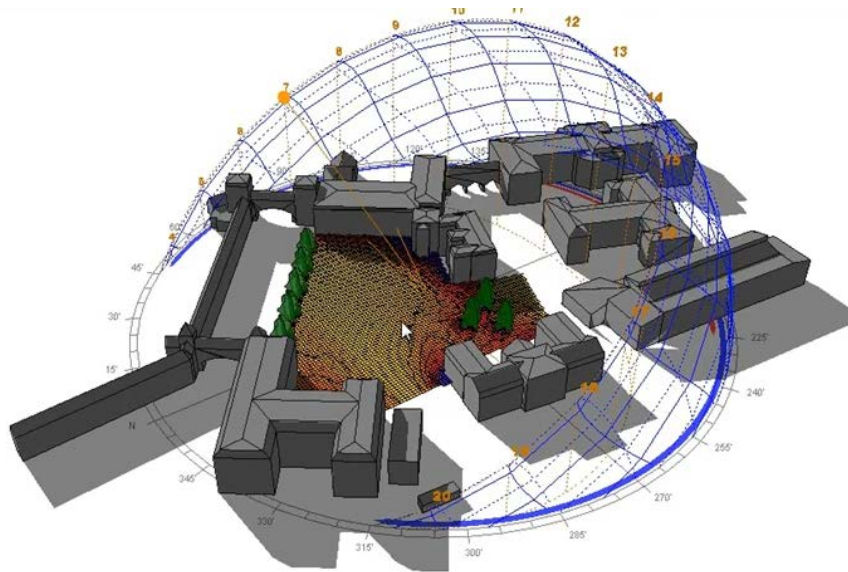

Figure 4.27. Solar radiation and shading studies with Autodesk Ecotect. Available at <http://sustainabilityworkshop.autodesk.com/software/ecotect> (last visit 2 May 2013).

Nowadays the energy performance of a building is very important and more attention is paid to the reduction of waste. For this reason the client must respect several laws and it is possible that he would require more efficient constructions. If the tender is based on the energy efficiency (e.g. the Viikki Synergy Building, more information is available in paragraph 4.6.4), commercial software programmes such as Autodesk Ecotect (Figure 4.27) can be used to evaluate:

4. Possible Implementation of BIM in Tendering

- Whole-building energy analysis: calculates the total energy used and carbon emissions of building model on an annual, monthly, daily and hourly basis, using a global database of weather information;
- Thermal performance: calculates heating and cooling loads for models and analyse effects of occupancy, internal gains, infiltration and equipment;
- Water usage and cost evaluation: estimates water consumption inside and outside the building;
- Solar radiation: visualises incident solar radiation on windows and surfaces over any period;
- Daylighting: calculates daylight factors and illumination levels at any point on the model;
- Shadows and reflections: displays the sun's position and path relative to the model at any date, time and location.

G. Cost calculation

BIM can be used to control if the final price of a bid is reliable or not in comparison with the offers. Specific software of cost estimation can be used (e.g. Tocoman, Vico Cost Planner) or a QTO can be obtained in SMC (Figure 4.28) and the client can later add the costs manually in an editable sheet (e.g. in excel).

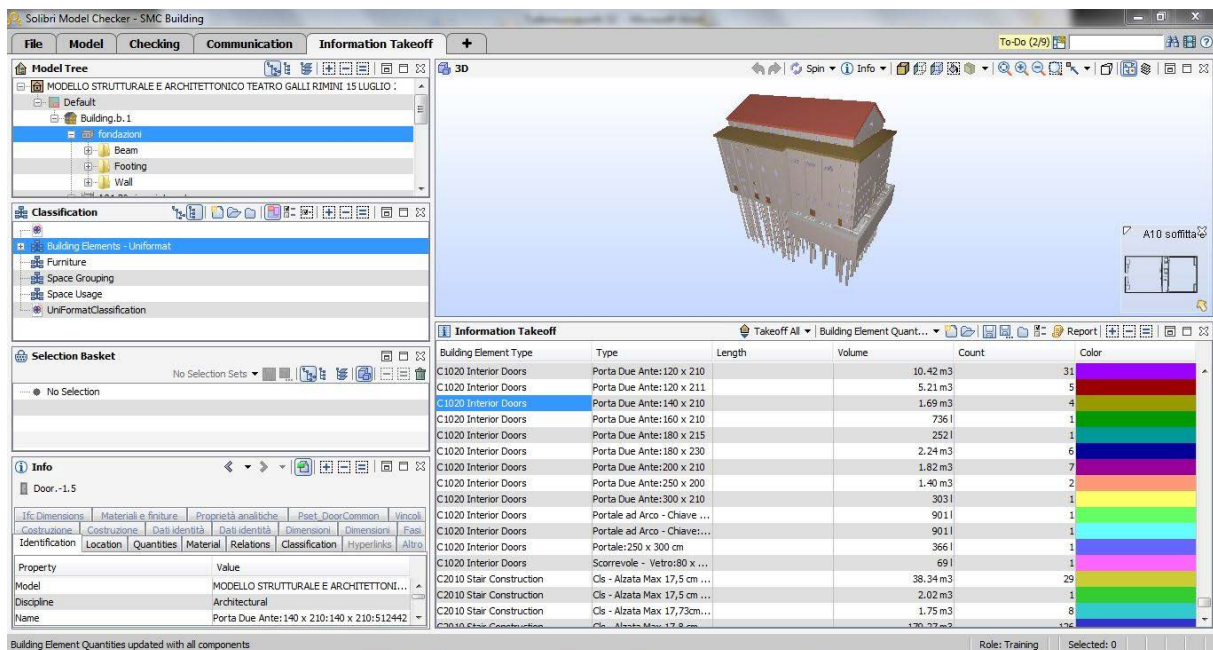

Building Element Type	Type	Length	Volume	Count	Color
C1020 Interior Doors	Porta Due Ante:120 x 210		10.42 m3	31	
C1020 Interior Doors	Porta Due Ante:120 x 211		5.21 m3	5	
C1020 Interior Doors	Porta Due Ante:140 x 210		1.69 m3	4	
C1020 Interior Doors	Porta Due Ante:160 x 210		736 l	1	
C1020 Interior Doors	Porta Due Ante:180 x 215		252 l	1	
C1020 Interior Doors	Porta Due Ante:180 x 230		2.24 m3	6	
C1020 Interior Doors	Porta Due Ante:200 x 210		1.82 m3	7	
C1020 Interior Doors	Porta Due Ante:250 x 200		1.40 m3	2	
C1020 Interior Doors	Porta Due Ante:300 x 210		303 l	1	
C1020 Interior Doors	Portale ad Arco - Chiave ...		901 l	1	
C1020 Interior Doors	Portale ad Arco - Chiave...		901 l	1	
C1020 Interior Doors	Portale:250 x 300 cm		366 l	1	
C1020 Interior Doors	Scorrevole - Vetrot:80 x ...		69 l	1	
C2010 Stair Construction	Cls - Alzata Max:17,5 cm ...		38.34 m3	29	
C2010 Stair Construction	Cls - Alzata Max:17,5 cm ...		2.02 m3	1	
C2010 Stair Construction	Cls - Alzata Max:17,73cm...		1.75 m3	8	
C2010 Stair Construction	Cls - Alzata Max:17,8 cm...		170.33 m3	126	

Figure 4.28. Information Takeoff tool in Solibri Model Checker v8.1.

Nowadays the bidders do not add the cost as a parameter of each component but they usually give a total price, however, maybe in the future they will add it as a property of objects and thanks to the QTO it will be possible to automatically obtain the total price as well.

H. Accessibility

Today more attention is also given to the accessibility of buildings, especially in the public sector. SMC has already translated in rulesets some regulations (such as the International ISO_DIS 21542 2009 Building construction – Accessibility and usability of the built environment; the International Code Council ICC/ANSI A117.1. 2003 American National Standard, Accessible and Usable Buildings and Facilities; and the Americans with Disabilities Act and Architectural Barriers Act Accessibility Guidelines July 23, 2004). The translation of codes in rules is quickly growing to improve so called Automated Code Checking (Ding, Drogemuller, Jupp, Rosenmanand Gero, 2004; Eastman, Lee, Jeong, and Lee, 2009; Greenwood, Lockley, Malsane and Matthews, 2010; Nguyen and Kim, 2011; Hjelseth, 2012). Also in Italy an interesting study related to accessibility has been carried on using SMC (Bellomo, 2012) (Figure 4.29). Some of the accessible rules are related to the control of slope and length of ramps, the validation of free floor space for utilisation of a wheelchair as well as the accessibility to stairs, doors and windows.

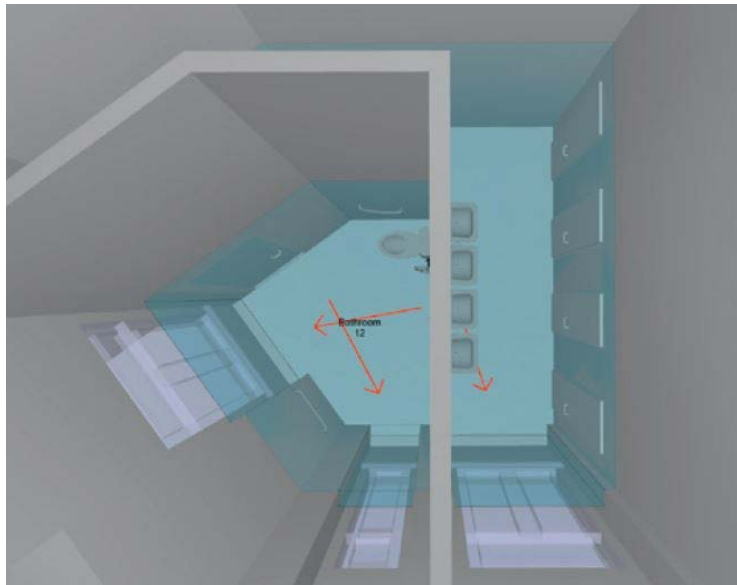

Figure 4.29. Example of check result of free space for a wheelchair in a bathroom with SMC (Bellomo, 2012).

I. Safety and Security

Particular importance is given also to safety and security in current public constructions (e.g. fire safety, theft security and occupational safety), especially for some building types (e.g. hospitals, schools, prisons). In 2013 Sulankivi, Zhang, Teizer, Eastman, Kiviniemi, Romo and Granholm have studied how BIM can be implemented for occupational safety on building construction sites. Moreover, the possible implementation of BIM for spatial access control configuration has been investigated by Skandhakumar, Reid, Dawson, Drogemuller and Salim in 2012. In SMC Egress Analysis rules are available to evaluate the safety of a building in case of emergency (Figure 4.30). It is possible to verify if all spaces are included in fire compartments, if their area is within limits, if all walls between different fire zones are the correct type and if doors and windows in these walls are fire resistant. If the building includes more than one floor there

is a rule that checks the presence of at least one component classified as 'Stair' in the vertical access classification, moreover, the presence of at least one exit door is always checked. The client can verify if all spaces have referencing relation at least to one door and if the exit spaces have at least one exit door. Other rules check that it is possible to exit safely in case of fire or other emergency ensuring the building has sufficient amount of suitable located exit passageways with sufficient capacity, so that exit time is not dangerously long. Finally, the minimum dimension of doors can be checked.

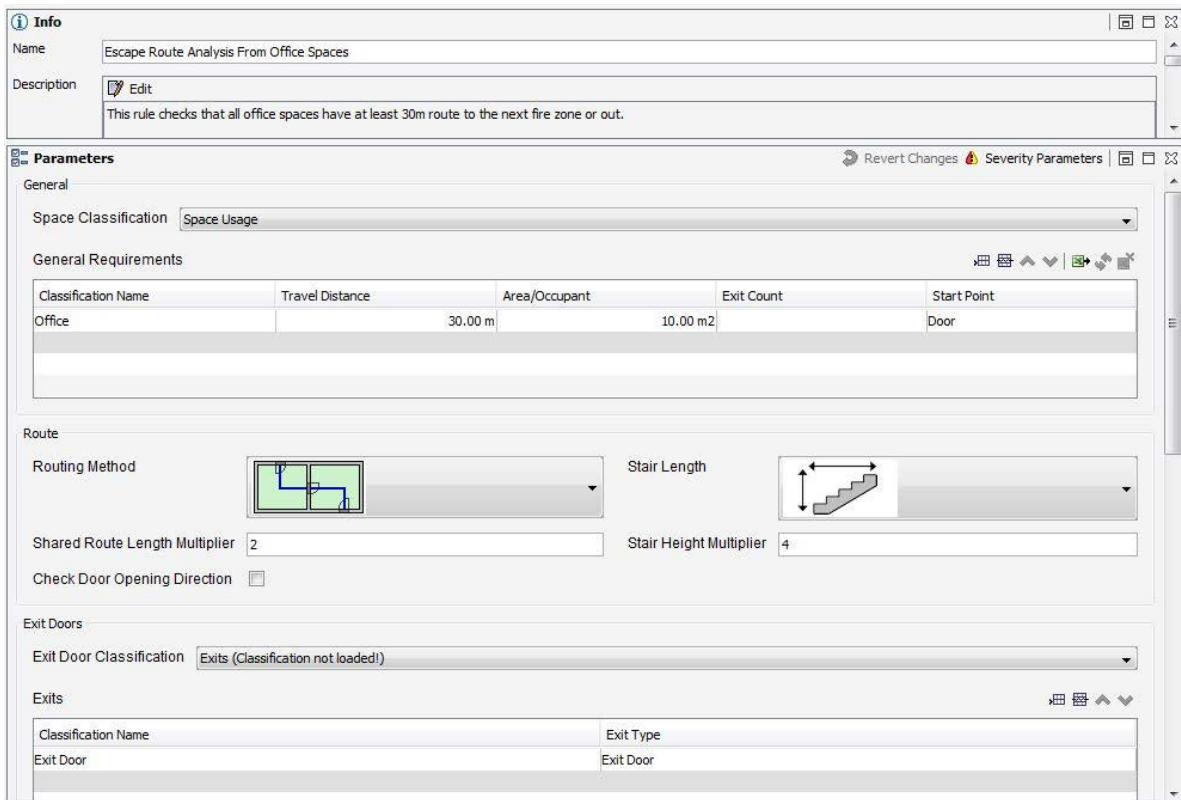

Figure 4.30. Example of rule for checking escape routes in Solibri Model Checker v8.1.

4.4.4 Examples of new kind of rules in SMC related to tendering

As already mentioned in the previous paragraphs, SMC gives the chance to customise built-in rules using the 'Workspace' of the Ruleset Manager tool. It is possible to open rules and change their parameters to fulfil own needs. The interface is quite user-friendly and there are text descriptions of the rules.

Below there are two examples showing the creation of new rules. The first consists in a simple modification of default values, while, the second deals with the customisation and combination of two ready-made rules.

A build-in rule to check the distance between spaces has been customised. The ready-made rule controls that Conference and Lobby spaces must be on the same floor, with maximum distance 4,57 m and also that the Restroom and the Corridor must have direct access (Figure 4.31 and Figure 4.32).

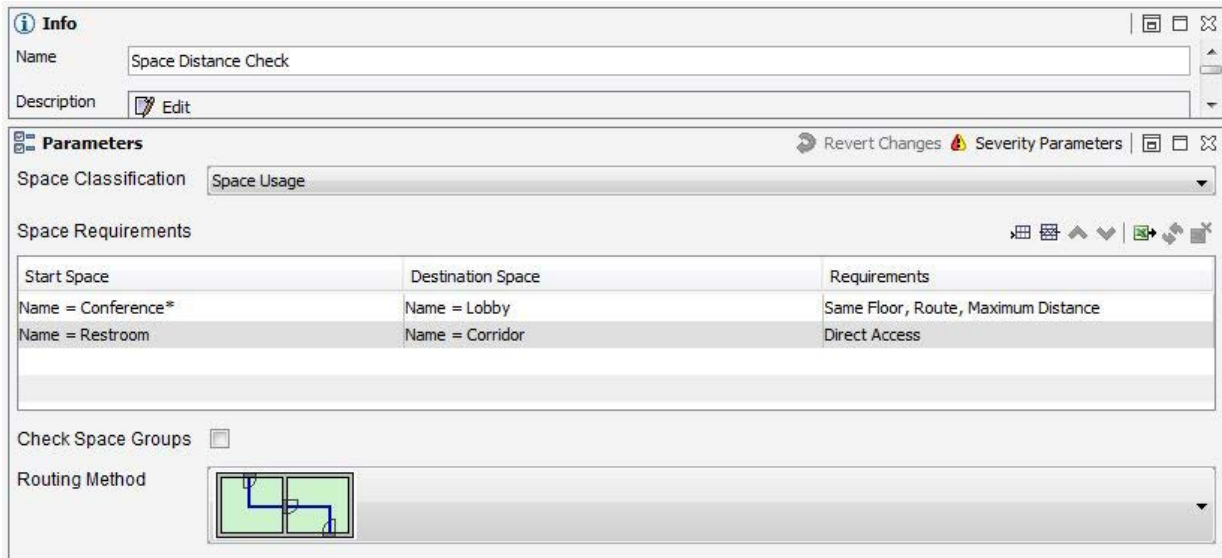

Figure 4.31. Space Distance Check rule in Solibri Model Checker v8.1.

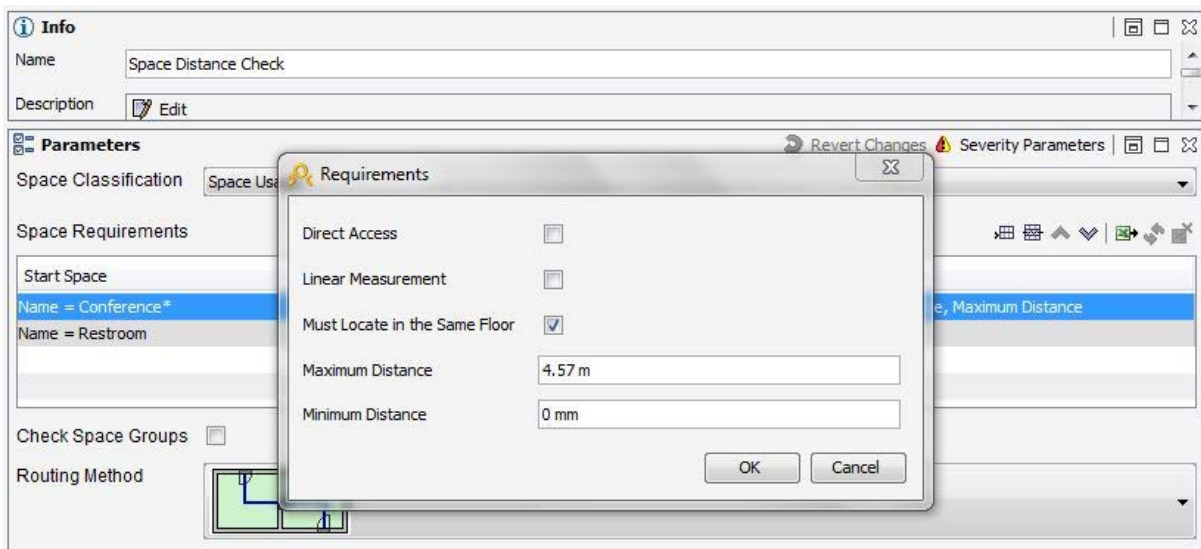

Figure 4.32. Requirements of the Space Distance Check rule in Solibri Model Checker v8.1.

If a client requires that the Kitchen must be at least 10 m far from the Gym, but on the same floor, they can modify the rule giving a new name (e.g. Space Distance Kitchen-Gym, instead of Space Distance Check) and selected different parameters and values (Figure 4.33). It is also possible to calculate the Routing Method in a different way.

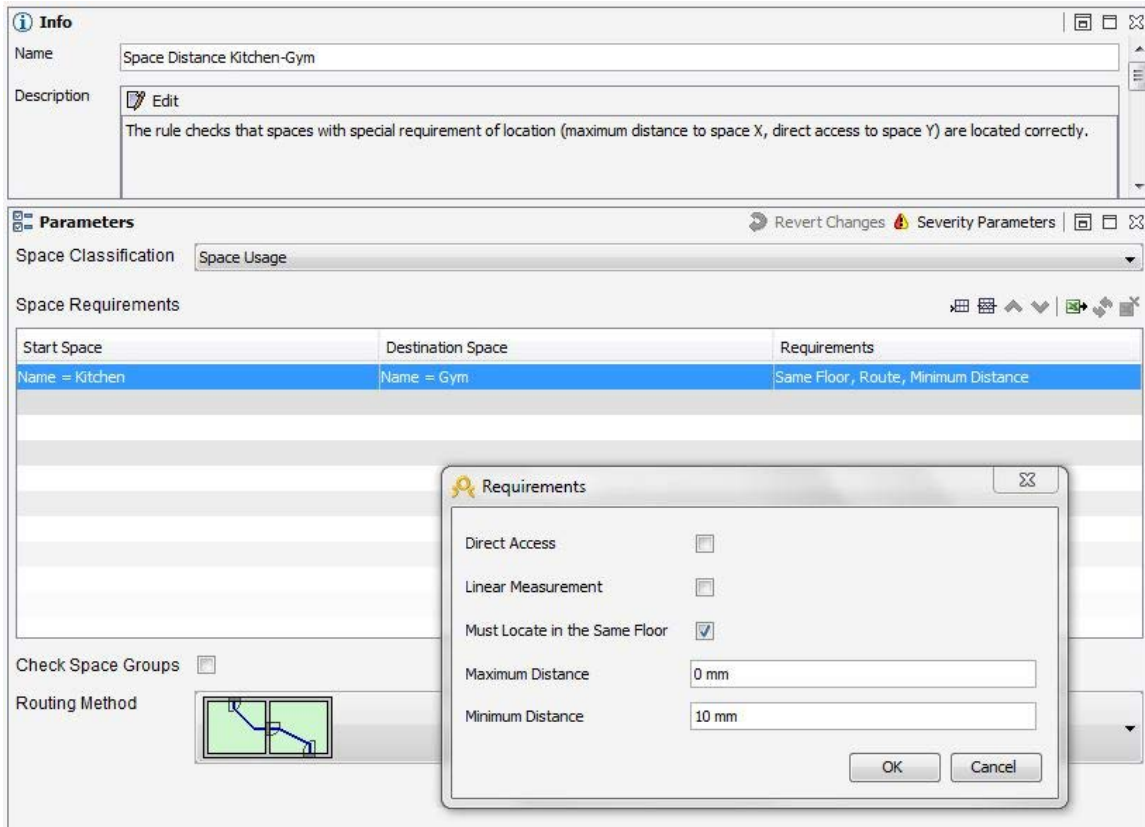

Figure 4.33. Customisation of the Space Distance Check rule in Solibri Model Checker v8.1.

However, the ready-made rules do not always cover all the cases, for this reason the help of the software developer staff is required to generate new rules. One example is the improvement of two rules to check a property of a component between two specific spaces.

The tender documentation of an Italian Case study was analysed to identify some requirements to be checked. All the tender documentation is available on line at <http://www.comune.rimini.it/servizi/gare_appalti/-lav_pubblici/pagina381.html> (last visit 15 May 2013) in Italian. The public tender was related to the rebuilding works of the Theatre 'Amintore Galli' of Rimini and the award criterion was based on the most economically advantageous tender. The tenderers were allowed to present variations only referring to the mechanical, electrical, fire resistance and special systems. A theatre must follow restrictive acoustic requirements to fulfil its function. In Italy the D.P.C.M. 5-12-97 defines the minimum acoustic values for different building types and a theatre belongs to the 'leisure centre' category (building type F of the building classification of the D.P.C.M. 5-12-97). The law indicates a minimum value of transmission loss $R_w > 50$ dB, but the acoustic specification for this theatre requires a more restrictive value $R_w \geq 53$ dB. This requirement must be respected for walls which isolate specific spaces, for example the changing rooms and the WC (full text in Italian available on line at <http://www.comune.rimini.it/binary/comune_rimini/allegati-gara-teatro/m-capitolati/M-REL07.pdf> last visit 15 May 2013).

In the tender phase a tenderer can include in the Building Information Model the acoustic certificate of transmission loss value in some walls and later the client can control if the value respects their requirement of $R_w \geq 53$ dB. In SMC there is a rule to

check properties of object using filters, Property Rule Template with Component Filters Rule (SOL/230). This rule checks only components that pass the filters in the 'Components to Check' table. The 'Requirements' table lists the requirements for the components. Both of these tables can contain at least one filter. With this rule, it is possible to create quite complicated 'if – then' rules. For example, the rule can require that all walls, whose construction type matches EW*, and whose height is over 3m, must have a thickness over 20cm and length over 1m.

First of all a classification 'Transmission Loss Walls' has been set, including all walls with the property 'Transmission Loss' (Figure 4.34).

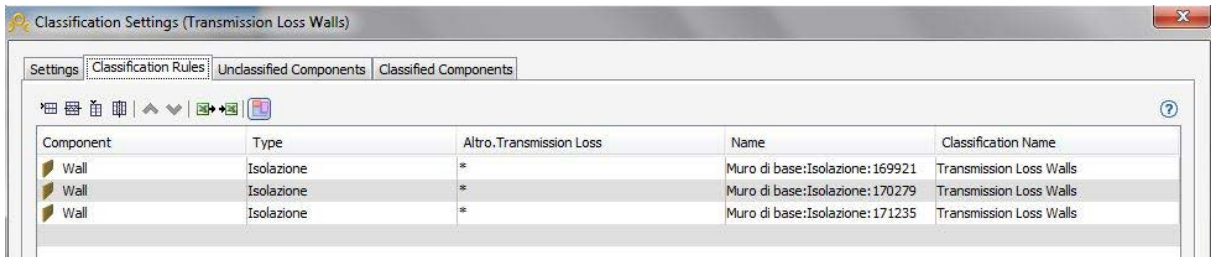

Figure 4.34. Classification of Transmission Loss Walls in Solibri Model Checker v8.1.

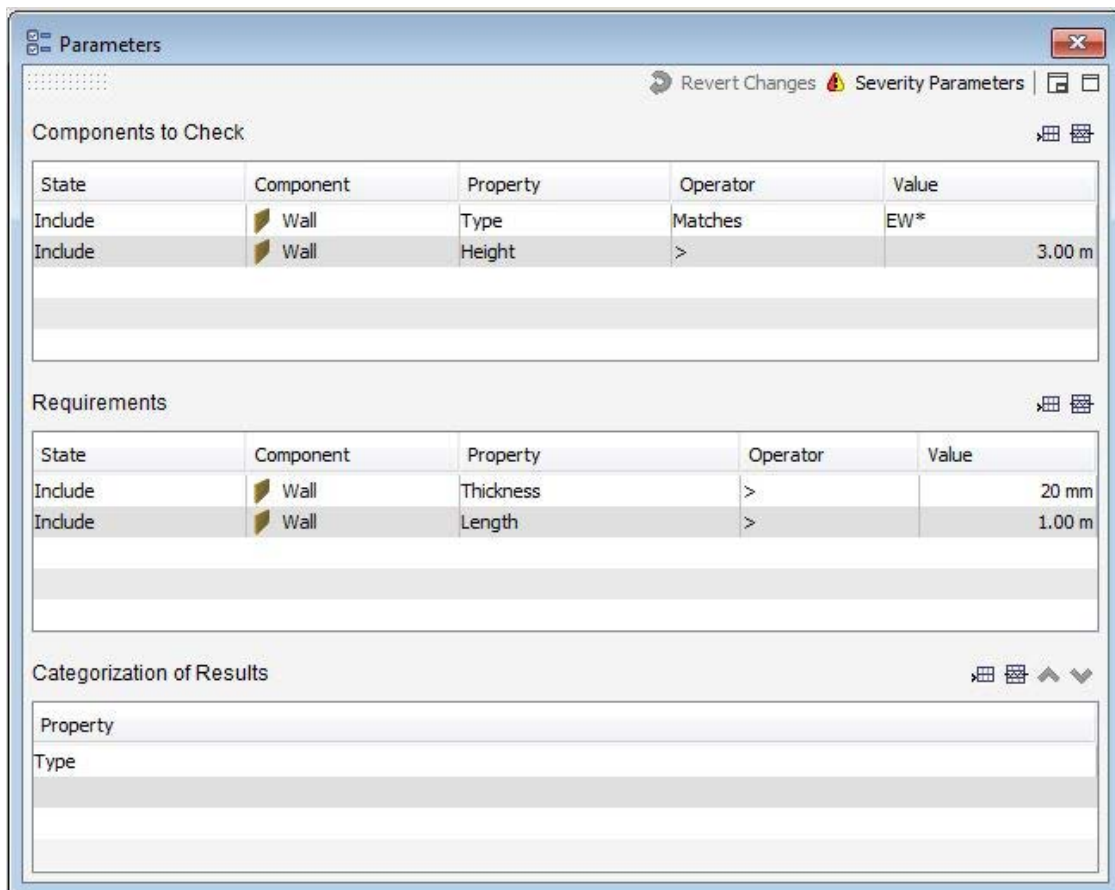

Figure 4.35. Property Rule Template with Component Filters rule (SOL/230) in Solibri Model Checker v8.1.

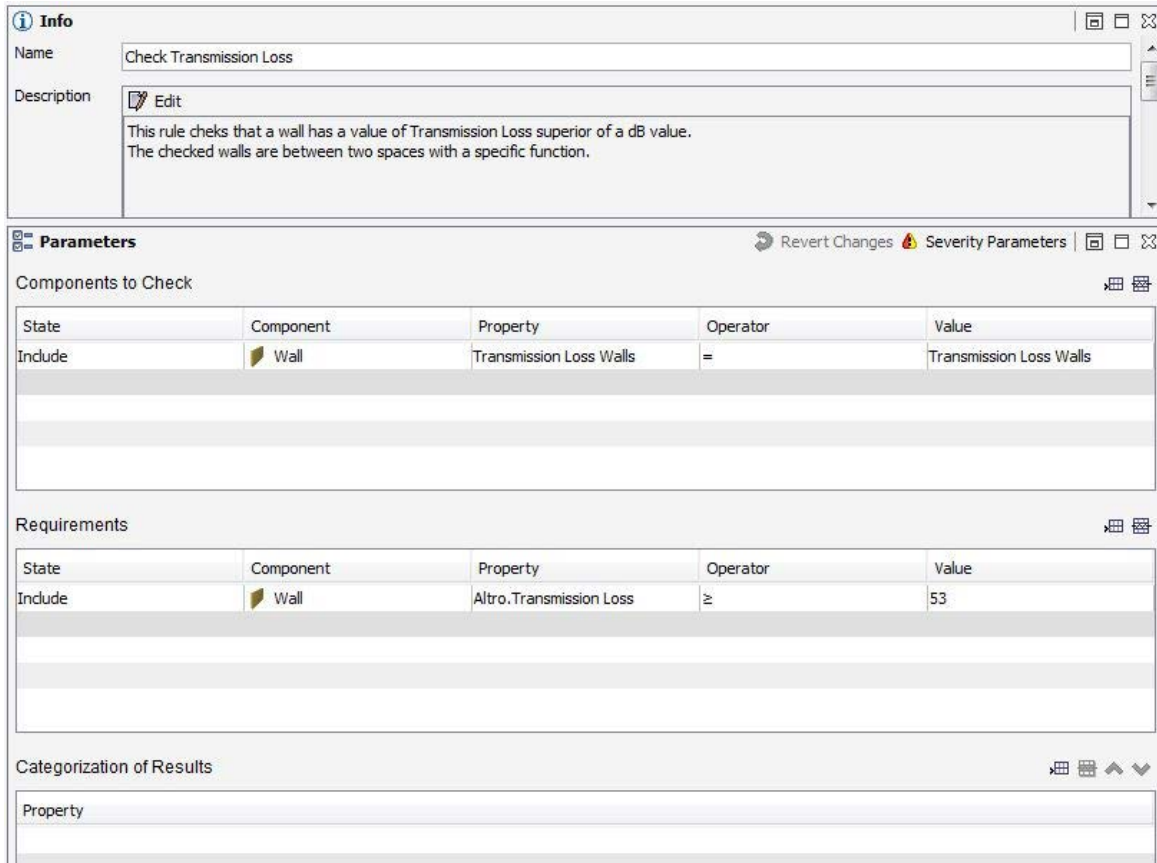

Figure 4.36. Check Transmission Loss rule in Solibri Model Checker v8.1.

Then the rule SOL/230 has been modified to check the walls included in the classification 'Transmission Loss Walls' which must have the property of 'Transmission Loss' \geq 53 dB (Figure 4.35), paying attention to select the format 'Integer' of the property, both in SMC (Figure 4.36) but also to add the property in the correct way in the native file.

This rule was not enough because it does not give the possibility to select the walls which isolate different spaces. For this reason another rule, Comparison Between Property Values (SOL/231), has been used. This rule compares property values between each other. The rule is very versatile, but also very abstract, which makes it challenging to be configured. With this rule it is possible to check for example, that a property value calculated in SMC matches the value given in a property set, or, that there are at least two inlet valves in offices that are larger than 10 m² or that a door has a relationship with maximum two spaces (Figure 4.37).

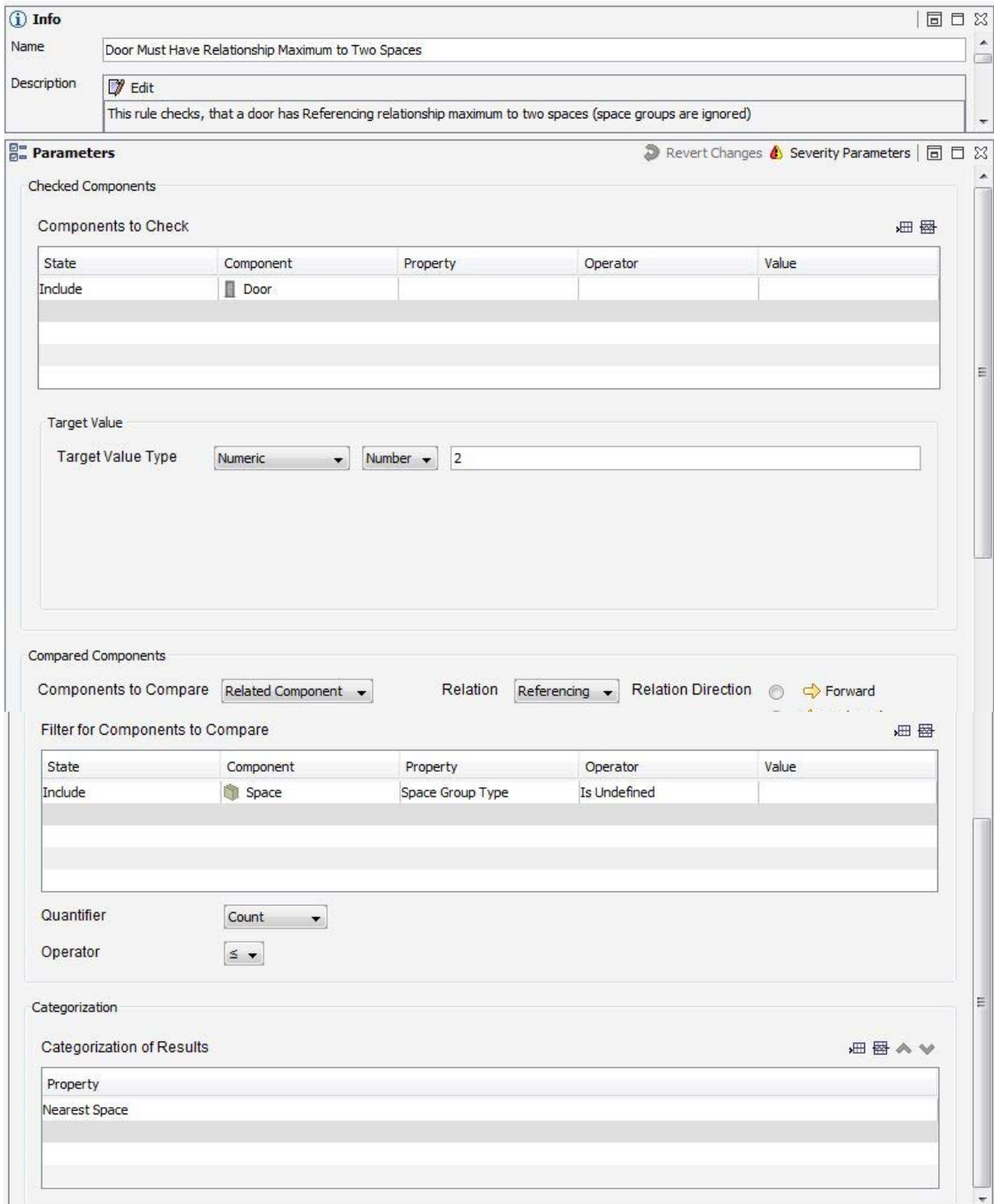

Figure 4.37. Comparison Between Property Values rule (SOL/231) in Solibri Model Checker v8.1.

4. Possible Implementation of BIM in Tendering

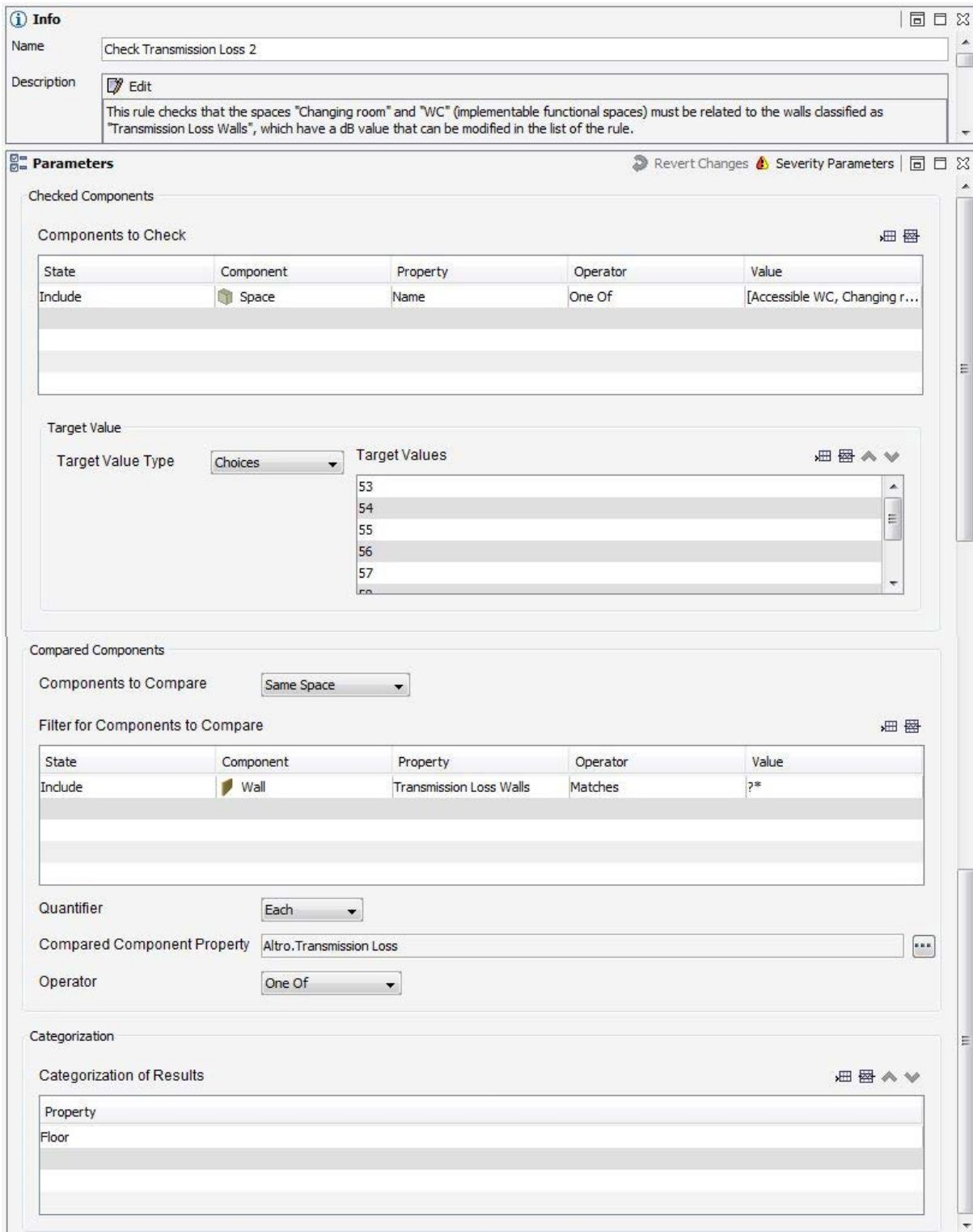

Figure 4.38. Check Transmission Loss 2 rule in Solibri Model Checker v8.1.

The rule SOL/231 has been modified to check that spaces with the name 'Changing room' or 'WC' or 'Accessible WC' or 'Showers' are isolated by walls with the value of the property 'Transmission Loss' included in the list of 'Target Values' (Figure 4.38).

A simulation was carried out given the value of 53 dB to two walls and 50 dB to another one which divided the Changing room and the Shower spaces. The rule accurately found the wrong value of 50 dB (Figure 4.39 and Figure 4.40).

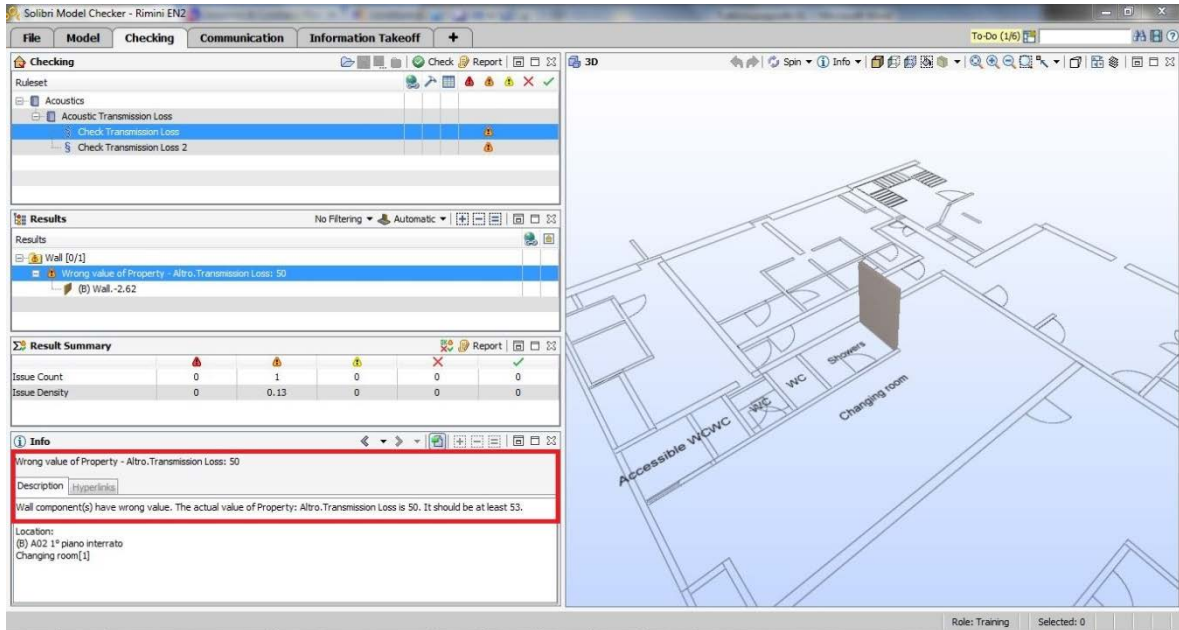

Figure 4.39. Checking Result of the Check Transmission Loss rule in Solibri Model Checker v8.1.

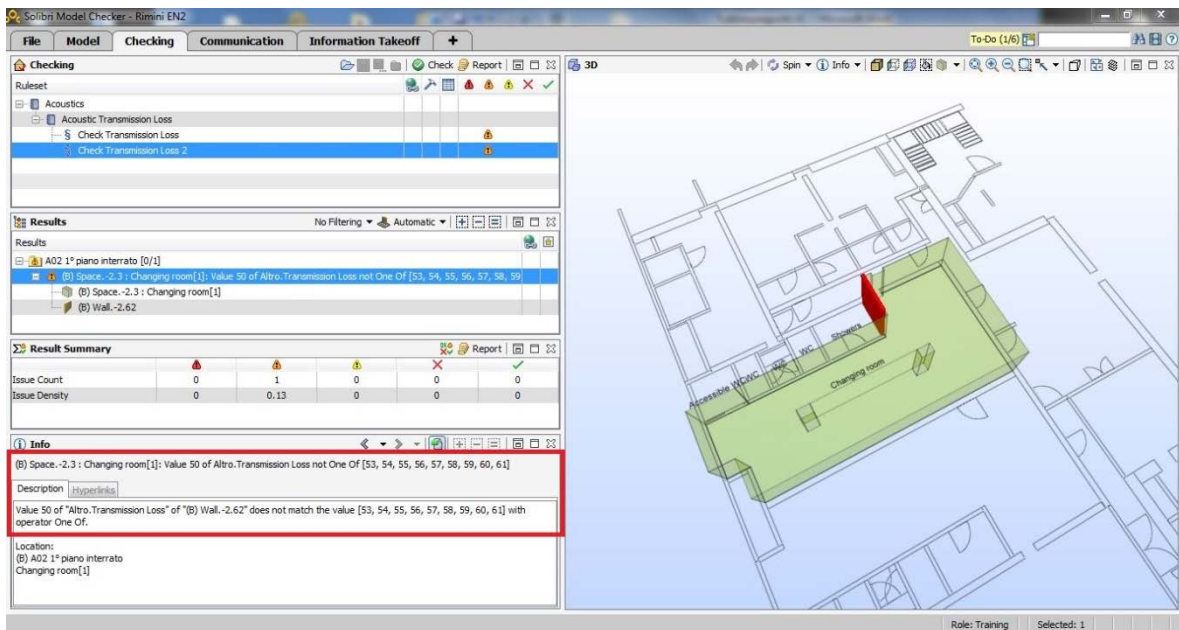

Figure 4.40. Checking Result of the Check Transmission Loss 2 rule in Solibri Model Checker v8.1.

4.4.5 Translation of Client's requirements in SMC: the Statsbygg BIM Manual

As already shown, Solibri Model Checker allows the translation of the Client's requirements into rulesets. In the 2012 version 7.1 of SMC introduced the ability to verify BIM compliance with the published Norwegian Statsbygg BIM Manual (SBM1.2) (Kulusjärvi and Widney, 2012) and in 2013 the last version 8.1 includes the Finnish National BIM Requirements (COBIM). The Client's written requirements have been converted into rules and both the BIM Manuals are available in English for all users. Solibri staff has supported the translation of other Client's requirements but they are not included in the basic license.

This paragraph describes the differences between the published version of Statsbygg Building Information Modelling Manual Version 1.2 (Statsbygg, 2011) and the rulesets in SMC to understand the possibilities and the limits of the software based on a case study.

In October 2011 the newest version 1.2 of the Statsbygg Building Information Modelling Manual (SBM1.2) was published based on the previous versions and the experience acquired from Statsbygg projects. The Manual is divided in the following main chapters:

- A. Introduction;
- B. Generic Requirements (Normative);
- C. Domain Specific Requirements (Normative);
- D. Modelling Quality and Practice;
- E. Building Information Modelling Spin-Off Deliverables (Informative);
- F. Classification (Informative);
- G. Project Specific Contract Addendum.

Only chapters B. and C. have been translated in rulesets in SMC (Figure 4.41).

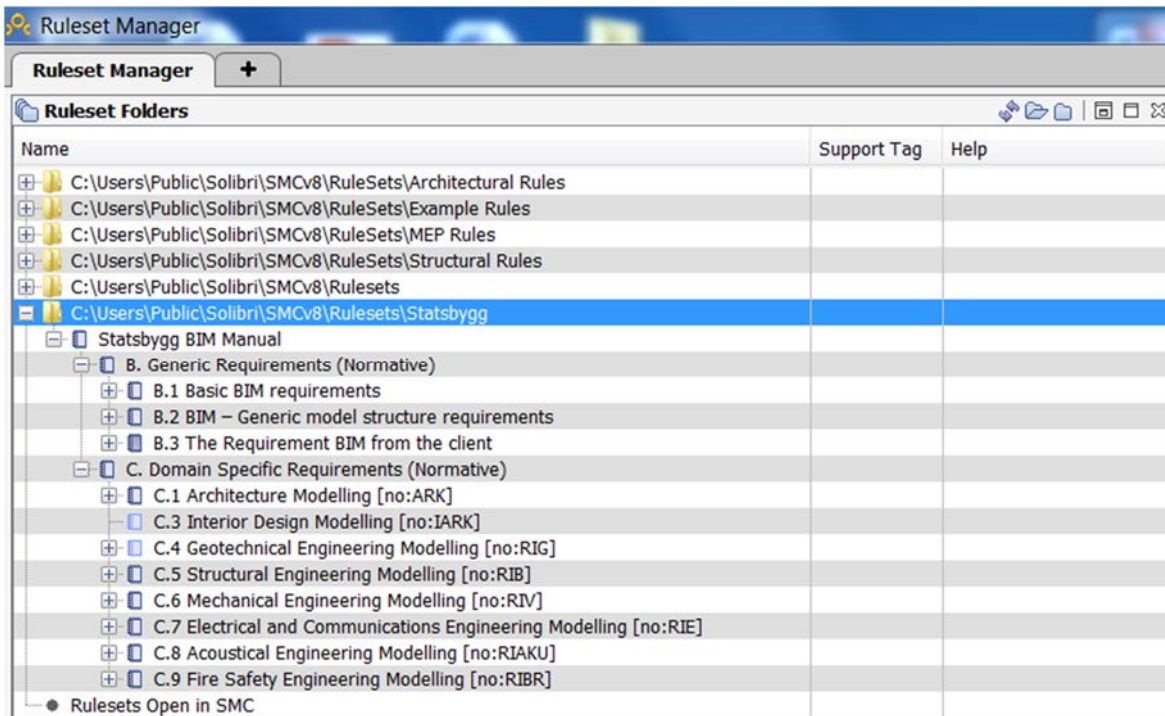

Figure 4.41. Rulesets of Statsbygg BIM Manual in Solibri Model Checker.

In SBM1.2 these two chapters contain mandatory, recommended, optional requirements and discouraged and prohibitive actions, in addition to any information that should be taken into consideration. Most of the rulesets in SMC are related to mandatory requirements. Chapter B. contains generic requirements and is subdivided in three parts:

- B.1 Basic BIM requirements;
- B.2 BIM – Generic model structure requirements;
- B.3 The Requirement BIM from the client.

In SMC all the requirements in paragraph *B.1* require manual checking because they are mostly related to the utilisation of BIM tools or file formats and not to properties of the models. Only *Ref. #8. BIM file naming conventions* has an equivalent ruleset which checks if BIM file names conform to a required naming scheme (Figure 4.42).

Reference	Description	Status	Help
Ref. #1.	Open BIM deliverable		
Ref. #2.	BIM objective(s)		
Ref. #3.	Open digital storage format for BIM to be submitted to client		
Ref. #4.	IFC release to be used		
Ref. #6.	BIM authoring tool information		
Ref. #7.	Original digital storage format for BIM to be submitted to client		
§ Ref. #8.	BIM file naming conventions - TBD	SOL/9/2.2	?
Ref. #9.	Project units		
Ref. #10.	Defining and geo-referencing the project zero		
B.2	BIM – Generic model structure requirements		
B.3	The Requirement BIM from the client		
C.	Domain Specific Requirements (Normative)		

Figure 4.42. Rulesets of Statsbygg BIM Manual in Solibri Model Checker, B.1 Basic BIM requirements.

Other rulesets are included in paragraph *B.2*. Indeed, *Ref. #11. Project* is validated using two rulesets: § *Only one Project object* and § *Project Name*. The former checks that one and only one project object is present for each project and the second, instead, controls if the project name contains the Client's project Number or other Project reference IDs. There are tree rulesets to validate *Ref. #12. Site*: it is possible to check if one and only one site object is present for each project (§ *Only one Site object*), if the Site Name has a value (§ *Site name*) and if the site has geometry (§ *Site Should Have Geometry*). On the other hand manual checking is required to control if the site name contains the official ID of the Cadastre. In addition, if partial models have been created (e.g. for separate buildings) and submitted as separate model files, manual checking or the Information Take-off tool 'Floor GUIDs' should be used to check if there are multiple floor instances with the same GUID (Global Unique Identifier) and the same name for the Site. *Ref. #13. Buildings* can be validated using § *Building ID* and § *Building Name* rulesets to check if the ID and names have been modelled in the right way. Also the name and the number of Storeys can be checked with similar rulesets (§ *Storey Number* and § *Storey Name*). A manual control, using for example the Model Tree View tool, is required to verify if one or more storey objects are included for each building, reflecting the number of floor levels in the building. In SMC there are different rulesets to validate the properties of spaces (*Ref. # 15, 16, 17, 18, 19, 20, 22*), for example it is possible to check if spaces have been modelled with 3D space objects (§ *Model Should Have Spaces*) and if they exist for all areas that represent a defined function (§ *Unallocated Areas*). Moreover, there are two rulesets to check if space geometry follows the walls around the space and if spaces are located on top of slabs (§ *Space Validation*) and if there are intersections between spaces (§ *Space Intersections*). However, it is also possible to check if spaces are touching, but not intersecting, a suspended ceiling or a slab above them (*Ref. #22. Spaces – Functional space heights*). A manual checking, instead, is required to control if outdoor space functions have been modelled in the BIM as spaces even though they may not be physically delimited by walls. § *Space Numbers Must Be In Correct Format* is useful to examine if the spatial programme has been set accurately and § *Spaces Must Have Name* to validate names of spaces. According to the Norwegian standard way to calculate the total gross area of each storey, two rulesets give the possibility to control if this information is included in

the total gross area ('BTA' in Norwegian) space (§ *Every Floor Should Have BTA Space Object* and § *Spaces Must Be Included in BTA*). If some space functions in the client's spatial programme have been listed without a programmed area and no specific space area requirement has been set for the function, the rulesets § *Zero Gross Area Spaces* and § *Zero Net Area Space* can be used to control if their gross and net area are zero. The SBM1.2 recommends to express a gross volume in the Building Information Model adding an attribute (*Ref. #23. Volumes*), but a ruleset is not yet available in SMC to fulfil this requirement. Moreover, a manual check is required to analyse the height of the roof cornice and roof ridge. If the model contains zones (aggregations of spaces), it is possible to analyse them manually using the Model Tree View and the same tool could be used to validate the presence of systems (*Ref. #27. Systems*). In the Building Information Model all entities must be modelled as occurrences (instances) of the 'thing' they represent (e.g. doors, ducts) and entities should also contain a type. 'Occurrence' properties contain information about each individual entity (e.g. a ventilation duct), like location and relation to space; on the other hand 'type' properties contain information about the type of the entity, such as the manufacturer and product type number. In SMC it is possible to check if for each occurrence the GUID for its defined type object is identical and if all entities follow naming conventions according to the Norwegian Standards (§ *Component Names Must Be According to Standard*). Both spatial structure elements and building elements contain basic information on quantities (e.g. area, volume, etc.) and two different rules can validate it (§ *Quantities for Building Components* and § *Gross Area for Spaces*). Finally, it is possible to utilise a ruleset which controls if the layers in the Building Information Model are in compliance with the Norwegian Standards (§ *Layer of Component Must Be According to Standard*) (Figure 4.43).

4. Possible Implementation of BIM in Tendering

B.2 BIM – Generic model structure requirements			
Ref. #11. Project			
§ Only one Project object	SOL/176/1.5		?
§ Project Name	SOL/9/2.2		?
Ref. #12. Site			
§ Only one Site object	SOL/176/1.5		?
§ Site Land Title Number			
§ Site name	SOL/9/2.2		?
§ Site Should Have Geometry	SOL/176/1.5		?
§ Site Object of Partial Models Should Have the Same GUID			
Ref. #13. Buildings			
§ Building ID	SOL/9/2.2		?
§ Building Name	SOL/9/2.2		?
Ref. #14. Storeys			
§ Each Building Must have Storeys			
§ Storey Number	SOL/9/2.2		?
§ Storey Name	SOL/9/2.2		?
Ref. #15. Spaces - In general			
§ Model Should Have Spaces	SOL/11/2.3		?
§ Unallocated Areas	SOL/202/1.2		?
§ Space Height	SOL/202/1.2		?
§ Space Geometry			
§ Space Validation	SOL/202/1.2		?
§ Space Intersections	SOL/1/3.0		?
Ref. #16. Spaces - Functional			
§ Space Numbers Must Be In Correct Format	SOL/21/2.0		?
Ref. #18. Spaces - The Gross Area Object			
§ Every Floor Should Have BTA Space Object	SOL/38/1.5		?
§ Spaces Must Be Included in BTA	SOL/162/1.3		?
Ref. #17. Spaces - Technical			
§ Spaces Must Have Name	SOL/20/1.3		?
Ref. #19. Spaces - External			
§ External Spaces Must Exist			
Ref. #20. Spaces - Without a programmed area			
§ Zero Gross Area Spaces	SOL/230/1.0		?
§ Zero Net Area Space	SOL/230/1.0		?
Ref. #22. Spaces - Functional space heights			
§ Spaces Must Touch Suspended Ceilings or Slab above	SOL/23/5.0		?
§ Spaces Should Not Intersect with Suspended Ceilings	SOL/1/3.0		?
Ref. #23. Volumes			
§ Value for Gross Volume - TBD			
§ Gross Volume for Buildings Storeys Above Ground - TBD			
Ref. #24. Roof cornice and roof ridge			
Ref. #25. Physical building elements			
Ref. #26. Zones			
§ Model Should have Zones			
Ref. #27. Systems			
§ Model Should have Systems			
Ref. #29. Modeling with both Occurance and Type objects			
§ Components must Have Type	SOL/11/2.3		?
Ref. #30. Naming if entities in general			
§ Component Names Must Be According to Standard	SOL/9/2.2		?
Ref. #31. Base quantities of spatial structure elements and building elements			
§ Quantities for Building Components	SOL/203/2.2		?
§ Gross Area for Spaces	SOL/203/2.2		?
Ref. #32. CAD Layers			
§ Layer of Component Must Be According to Standard	SOL/17/1.5		?

Figure 4.43. Rulesets of Statsbygg BIM Manual in Solibri Model Checker, B.2 BIM – Generic model structure requirements.

The last paragraph of Chapter B. (Figure 4.44) defines the Client's BIM requirements which are provided in most cases. They include the spatial programme's required spaces, functional grouping of the spaces and any requirements that are defined for each space, group, or accompanying Furniture, Fittings & Equipment. Statsbygg currently utilises the software dRofus (for more information see paragraph 4.4.2) for expressing these BIM Requirements. Using SMC, instead, it is possible to check:

- the presence of only one Project;
- the compliance of its name with the Client's project number and reference ID (*Ref. #33. Project* which is similar to *Ref. #11*);
- if there is at least one site object and the accuracy of its name (*Ref. #34. Site* which is similar to *Ref. #12*);
- the accuracy of names and numbers of functional zones (*Ref. #35. Functional Zones*);
- the accuracy of spaces (§ Model Should Have Spaces, § Space Function Name Format, § Spaces Must Have Name);
- the value of the programmed area in the client's spatial programme (§ *Spaces Must Have Required Functional Area*).

Statsbygg's requirement database can export 'dummy' geometry for the space objects. This implies that a simple geometric 'Lego block' represents each space's programmed area, and it is easier for BIM Authoring tools (CAD systems) to 'select and drag' the required spaces to the correct location in the model. The space names will then be preserved in the architectural design model giving the possibility to check compliance with the area programme (*Ref. #37. 'Dummy' geometry of spaces*). In SMC the ruleset § *'Dummy' Geometry Area Must be Same as Required Area* can be used to validate if the area of 'Lego block' spaces is the same as the programmed one.

B.3 The Requirement BIM from the client			
Ref. #33. Project			
§ Only one Project object	SOL/176/1.5		?
§ Project Name	SOL/9/2.2		?
Ref. #34. Site			
§ Site objects	SOL/176/1.5		?
§ Site name	SOL/9/2.2		?
Ref. #35. Functional Zones			
§ Functional Zone Name	SOL/9/2.2		?
§ Functional Zone Description	SOL/9/2.2		?
Ref. #36. Spaces			
§ Model Should Have Spaces	SOL/11/2.3		?
§ Space Function Name Format	SOL/21/2.0		?
§ Spaces Must Have Name	SOL/20/1.3		?
§ Spaces Must Have Required Functional Area	SOL/203/2.2		?
Ref. #37. "Dummy" geometry of spaces			
§ "Dummy" Geometry Area Must be Same as Required Area	SOL/231/1.0		?

Figure 4.44. Rulesets of Statsbygg BIM Manual in Solibri Model Checker, B.3 The Requirement BIM from the client.

Chapter C. concerns specific requirements and is divided in thirteen paragraphs:

- C.1 Architecture Modelling;
- C.2 Landscape Architecture Modelling;
- C.3 Interior Design Modelling;
- C.4 Geotechnical Engineering Modelling;

- C.5 Structural Engineering Modelling;
- C.6 Mechanical Engineering Modelling;
- C.7 Electrical and Communications Engineering Modelling;
- C.8 Acoustical Engineering Modelling;
- C.9 Fire Safety Engineering Modelling;
- C.10 Other Design and Engineering Modelling;
- C.11 BIM Construction and As Built Requirements;
- C.12 BIM for Facility Management and Operations;
- C.13 BIM for Decommissioning and Disposal.

In SMC there are only C.1, C.3, C.4, C.5, C.6, C.7, C.8 and C.9.

Paragraph C.1 concerns the architectural modelling and it is further divided in three parts (Figure 4.45):

- Outline conceptual design – Default modelling requirements;
- Full Conceptual Design – Default modelling requirements;
- Coordinates design, procurement and full financial authority – Default modelling requirements.

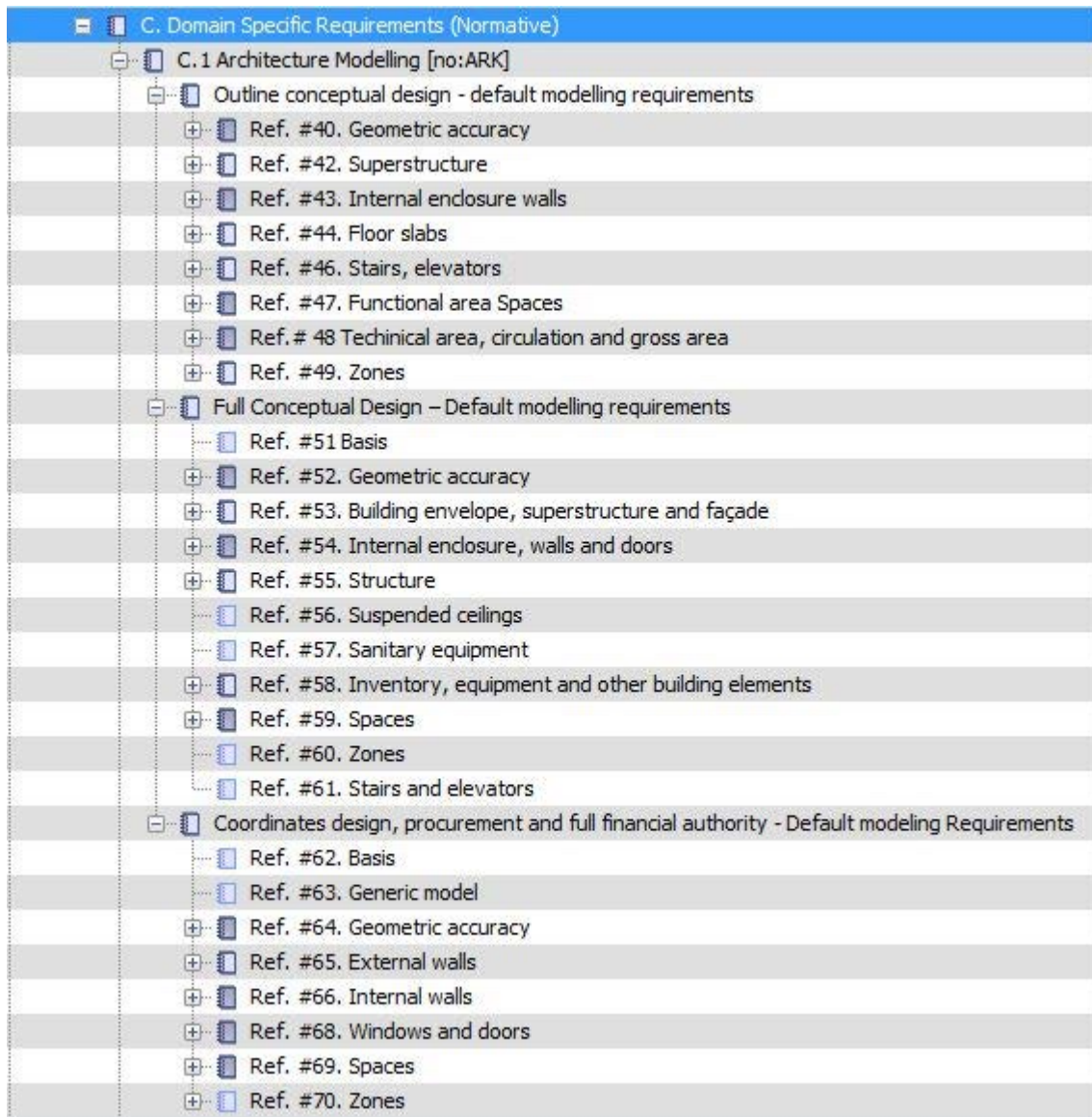

Figure 4.45. Rulesets of Statsbygg BIM Manual in Solibri Model Checker, C.1 Architecture Modelling.

The first part is related to requirements for Geometric Accuracy (Ref. #40.), External enclosure/building envelope (Ref. #41.), Superstructure (Ref. #42.), Internal enclosure walls (Ref. #43.), Floor slabs (Ref. #44.), Major equipment/inventory objects (Ref. #45.), Stairs, elevators (Ref. #46.), Functional area Spaces (Ref. #47.), Technical area, circulation and gross area (Ref.# 48.) and Zones (Ref. #49.). In SMC there are all these requirements except the recommended one concerning the equipment or inventory which could have potential structural consequences (Ref. #45.). The Geometric accuracy is validated using intersections rulesets between same or different kinds of components and also between furniture and other objects. After the parameterisation of two rules, according to the current project, it is possible to check the compliance of name and types of external walls and if objects in the building envelope (such as roof, external walls, windows and doors), have been identified as external elements. The SBM1.2 demands that the properties of thickness and material of walls do not have to differ

within the same wall type; in SMC there is a ruleset to validate the former requirement (§ Wall Thickness Must Be Consistent) but not the second. A manual check is also required to control if all spaces with climate/comfort requirements have been encircled by the building envelope (anyway the Compartmentation View tool can be used to visualise walls in the Building Envelope compartment). Finally, the ruleset § Wall Height can check if the height of walls is in accordance to the planned floor height, and modelled from the top surface floor slab in storey n , to the bottom surface in storey $n+1$. Referring to Superstructure (Ref. #42.), there is ruleset to control the conventional names of load bearing elements (§ Naming Convention of Load Bearing Building Elements) which must be checked though if modelled in the early stage. If the model contains internal walls, it is possible to utilise similar rulesets of Ref. #41. External enclosure/building envelope and other rulesets to validate the name and types of doors. The SBM1.2 requires the presence of at least one floor slab for each storey according to the structural engineer, and a different classification (base slab for slab on ground, floor for slab(s) between storeys and roof for top or roof slabs) but there is not a ruleset to automatise this check. Moreover, in SMC there is a ruleset to validate the compliance of the thickness of slabs but not for their material (as for the walls in Ref. #41.). Both Stairs and Elevators should be modelled and a ruleset checks their presence in SMC (§ Model Should Have Stairs and Elevators), it is possible to validate also the stair name and type but not the stair tag. Moreover, Ref. #46. requires the presence of elevator shafts, a space object within the shaft walls and a specific type enumeration, but in SMC there are no rulesets for these issues. Ref. #47. can be validated using the rulesets § Space Numbers Must Be In Correct Format and § Spaces Must Have Name (similar to Ref. #16. and Ref. #17.). It is possible to control if the model contains technical room for ventilation (§ Model Should Have Technical Spaces), vertical ducts (§ Model Should Have Vertical Ducts), circulation area (§ Model Should Have Circulation Spaces) and if there is the gross area for each storey (§ Every Floor Should Have BTA Space Object). The existence of zones, instead, requires a manual check.

The second part of paragraph C.1, Full Conceptual Design – Default modelling requirements, consists of Basic requirements (Ref. #51.) and requirements for Geometric accuracy (Ref. #52.), Building envelope, superstructure and façade (Ref. #53.), Internal enclosure, walls and doors (Ref. #54.), Structure (Ref. #55.), Suspended ceilings (Ref. #56.), Sanitary equipment (Ref. #57.), Inventory, equipment and other building elements (Ref. #58.), Spaces (Ref. #59.), Zones (Ref. #60.) and Stairs and elevators (Ref. #61.).

All the architectural requirements from the previous part are the basis for this phase. However, in SMC there is not a ruleset to check compliance with this requirement. The Geometric accuracy can be controlled using the same kind of rulesets included in the first part (Ref. #40. *Intersection Checking*). It is possible to check if all building elements have been modelled with relevant object entities for occurrences and type objects (§ *Components must have type*) but a manual check is required to control the presence of cost-demanding coverings and special equipment in the façade such as an external sun shield. Ref. #54. requires all internal walls and doors to be modelled with specific attribute properties (e.g. value of fire and acoustic rating, if the walls are or not load bearing, external or compartmentalization, if doors are or not fire exits). This requirement can be checked using rulesets which find out if walls and doors have values for different properties. To control the accuracy of the columns (Ref. #55.) there are several rulesets which check their dimension, the connection with other components

above and below them and the overlapping of the same parts in the architectural and structural models. A manual check is required to control the front cover of the wall types. Moreover, the Suspended ceilings (*Ref. #56.*) and the Sanitary Equipment (*Ref. #57.*) have no equivalent rulesets in SMC. Instead the names of the Inventory, Equipment and other building elements (*Ref. #58.*) can be controlled. In SMC there are rules useful to validate the names of spaces and their presence in the model (*Ref. #59.*). Finally, *Ref. #60.* dealing with Zones and *Ref. #61.* dealing with Stairs and elevators need manual check as in the first part (*Ref. #46.* and *Ref. #49.*).

The last part of C1, Coordinated design, procurement and full financial authority – Default modelling requirements, includes Basic (*Ref. #62.*) and Generic model requirements (*Ref. #63.*) and requirements for Geometric accuracy (*Ref. #64.*), External (*Ref. #65.*) and Internal (*Ref. #66.*) walls, Suspended ceilings (*Ref. #67.*), Windows and doors (*Ref. #68.*), Spaces (*Ref. #69.*) and Zones (*Ref. #70.*).

Also in this case the previous part is requested as a basis (*Ref. #62.*) but SMC cannot control it automatically. A manual check is required also to check that complete assemblies of all components are modelled at a detailed generic (non-product specific) level, suitable for tendering purposes (*Ref. #63.*). There are rulesets for the Geometric accuracy (*Ref. #64.*) similar to the ones of the previous part to check the intersections and if components have other components above and below them. The rule § *Wall objects shall contain material layers* controls that both External (*Ref. #65.*) and Internal (*Ref. #66.*) walls have at least two material layers defined. Also in this case there is not a rule for check the requirements for the Suspended ceilings (*Ref. #67.*). The ruleset § *Model must have windows and doors* can be used to validate the presence of internal and external doors (*Ref. #68.*). Finally, there are similar rulesets for the Space validation (*Ref. #69.*) but there are no rules for the Zones one (*Ref. #70.*).

Landscape Architectural Modelling requirements (C.2) are not available in SMC because they are not mandatory. Moreover, there are no rulesets for the next paragraph C.3 dealing with the Interior Design Modelling but there is only the title, even if *Ref. #74.* requires to check the name conventions of objects and in SMC there are already rules useful for this task. Geotechnical Engineering Modelling requirements (C.4), instead, are not developed by Statsbygg and there is limited experience, for this reason at present a manual check is required.

Section C.5 dealing with Structural Engineering Modelling is divided in the same tree parts as C.1.

The first part, Outline Conceptual Design – Default modelling requirements, contains *Ref. #76.* Preliminary investigations and external conditions, *Ref. #77.* Process, *Ref. #78.* Model structure and consistency and *Ref. #79.* Foundations, ground floor slabs, slabs, columns, beams and structural frame (Figure 4.46).

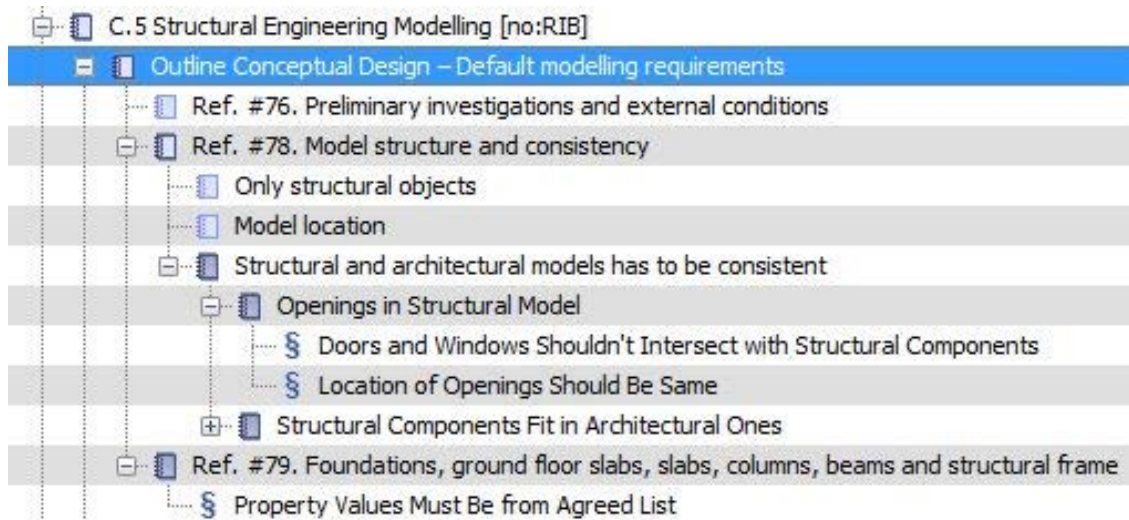

Figure 4.46. Rulesets of Statsbygg BIM Manual in Solibri Model Checker, C.5 Structural Engineering Modelling, Outline Conceptual Design – Default modelling requirements.

The first two requirements have not been translated in SMC because the former deals with geotechnical controls and the latter is not mandatory. Manual checks are required also to control if the Structural BIMs contain only structural objects and the accuracy of the position of the origin in the model. However, SMC gives the possibility to control the uniformity of Structural and Architectural models, required by *Ref. #78.*, thanks to the rulesets § *Doors and Windows Shouldn't Intersect with Structural Components*, § *Location of Openings Should Be Same* and § *Structural Components Fit in Architectural Ones*. Finally, rule § *Property Values Must Be from Agreed List* can be used to check the naming conventions for Foundations, ground floor slabs, slabs, columns, beams and structural frame (*Ref. #79.*).

The second part, Full Conceptual Design – Default modelling requirements, includes *Ref. #80.* Structural requirements, *Ref. #81.* Objective, *Ref. #82.* Model structure and consistency, *Ref. #83.* Component identification, *Ref. #84.* Foundations and *Ref. #85.* Ground floor slabs, slabs, columns, beams, structural frame and all other load-bearing elements (Figure 4.47).

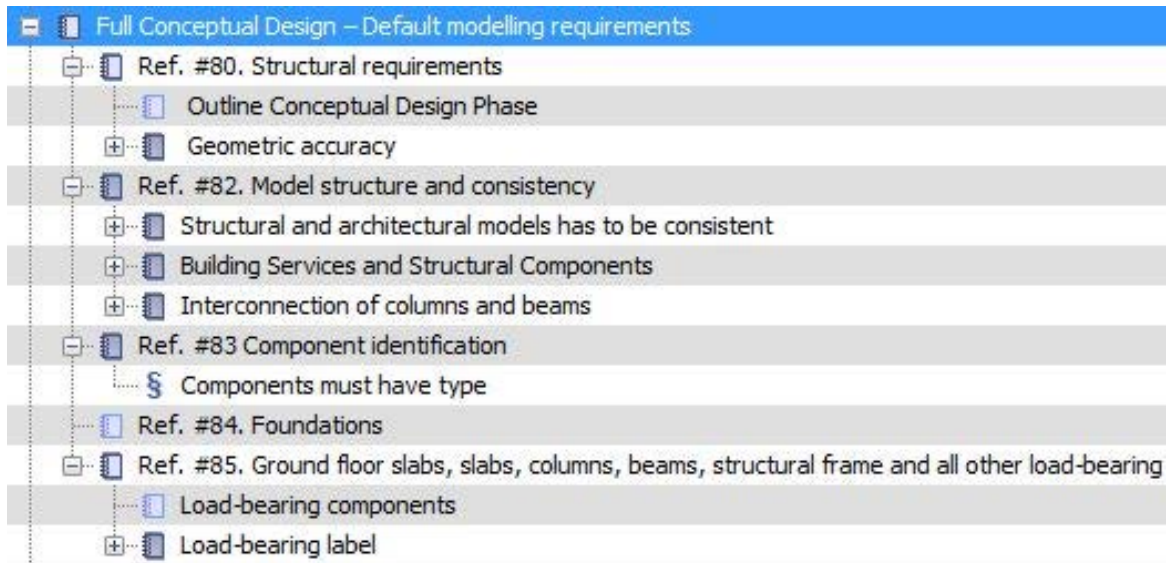

Figure 4.47. Rulesets of Statsbygg BIM Manual in Solibri Model Checker, C.5 Structural Engineering Modelling, Full Conceptual Design – Default modelling requirements.

Also in this case the previous part is basic and a manual check is needed (*Ref. #80.*); however, there are several rulesets to control the geometry accuracy. There is not *Ref. #81.* in SMC because it is only an information. *Ref. #82.* Model structure and consistency, instead, is validated thanks to rulesets which control the uniformity of the architectural and structural models (such as *Ref. #78.*), the intersection between building services and structural components and interconnections between beams and columns. Moreover, the rule § *Components must have type* is useful for checking the *Ref. #83.* Component identification requirement. *Ref. #84.* dealing with Foundations requires a manual check. Finally, it is not possible to control if all load-bearing vertical and horizontal structures have been modelled holding type, material, geometry, location and preliminary structural dimensioning data. However, there is a ruleset in SMC to validate their names (*Ref. #85.*).

The last part of paragraph C.5, Coordinated design, procurement and full financial authority – Default modelling requirements, contains *Ref. #86.* Structural requirements, *Ref. #87.* Objective, *Ref. #88.* Foundations, *Ref. #89.* All load-bearing elements and *Ref. #90.* Connection points and joinings (Figure 4.48).



Figure 4.48. Rulesets of Statsbygg BIM Manual in Solibri Model Checker, C.5 Structural Engineering Modelling, Coordinated design, procurement and full financial authority – Default modelling requirements.

All these requirements are not available in SMC, except *Ref. #88*. Foundations, where two rules check that foundations touch slabs, columns, or walls above or below them.

Paragraph C.6 deals with Mechanical Engineering Modelling and it is also divided in three parts. The first, Outline Conceptual Design – Default modelling requirements, includes *Ref. #91*. Spaces – Technical spaces, shafts, external pipe/duct traces (culverts) etc., *Ref. #92*. Entry points for technical infrastructure, *Ref. #93*. Major mechanical components and *Ref. #94*. Main ductwork and pipework at critical locations. All these requirements need a manual check, except the control of the name scheme of *Ref. #92*. (Figure 4.49).

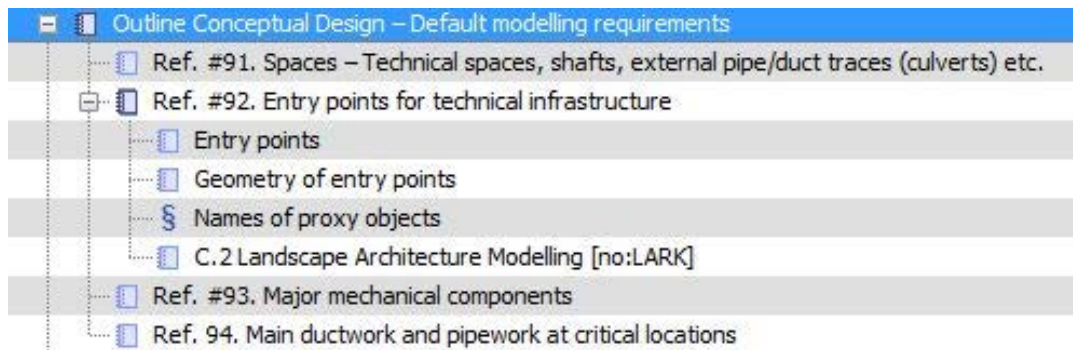

Figure 4.49. Rulesets of Statsbygg BIM Manual in Solibri Model Checker, C.6 Mechanical Engineering Modelling, Outline Conceptual Design – Default modelling requirements.

The second part, Full Conceptual Design – Default modelling requirements, comprehends *Ref. #95*. Mechanical requirements as in Outline Conceptual Design, *Ref. #96*. All mechanical components in technical spaces, shafts, external pipe/duct traces (culverts) etc., *Ref. #97*. All mechanical components in defined ‘type room’ spaces and *Ref. #98*. All mechanical components in defined ‘special’ spaces. The rules § *Intersections in mechanical models* and § *Duplicates in mechanical models* can be used to validate the accuracy of the geometry (*Ref. #95*). Moreover, there are rulesets to check if mechanical components have a type, if all objects are assigned to relevant systems and if the naming of systems is correct (*Ref. #96*). On the other hand there are no rulesets useful to validate *Ref. #97*. and *Ref. #98*. (Figure 4.50).

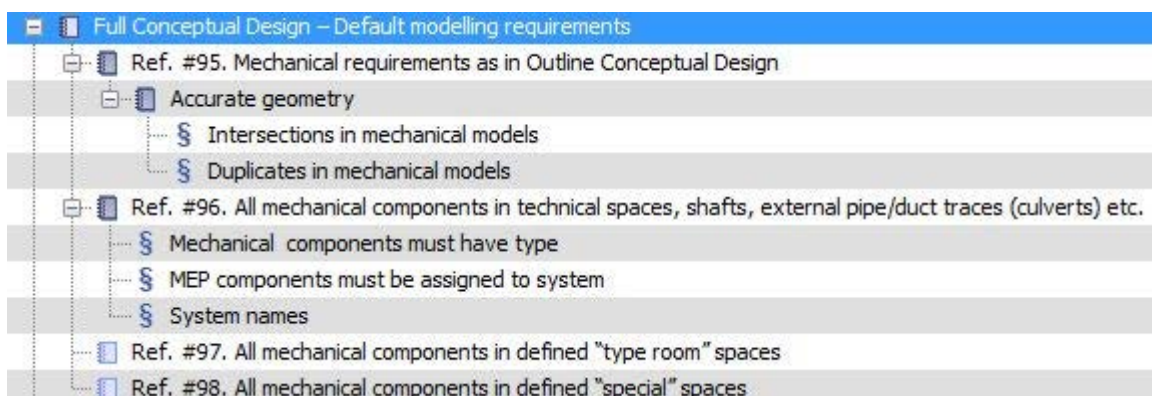

Figure 4.50. Rulesets of Statsbygg BIM Manual in Solibri Model Checker, C.6 Mechanical Engineering Modelling, Full Conceptual Design – Default modelling requirements.

The last part of paragraph C.6, Coordinated design, procurement and full financial authority – Default modelling requirements, includes *Ref. #99*. Mechanical requirements as in Full Conceptual Design, *Ref. #100*. All mechanical components in all spaces, *Ref. #101*. All mechanical route paths in all spaces and *Ref. #102*. Positioning mechanical components in suspended ceiling grids. *Ref. #99*. requires the requirements of the previous part as a basis, but it is not possible to check it automatically. Moreover, SMC does not include rulesets for checking the level of detail of components and the precise position within spaces for relevant mechanical equipment. However, there are similar rules for the accuracy of the geometry (such as for *Ref. #95*). The requirement *Ref. #100*. can be validated thanks to same rulesets as *Ref. #96*. SMC, instead, does not allow the automatic control of *Ref. #101*., but there is a rule for checking the intersections between components in HVAC models (*Ref. #102*.) (Figure 4.51).

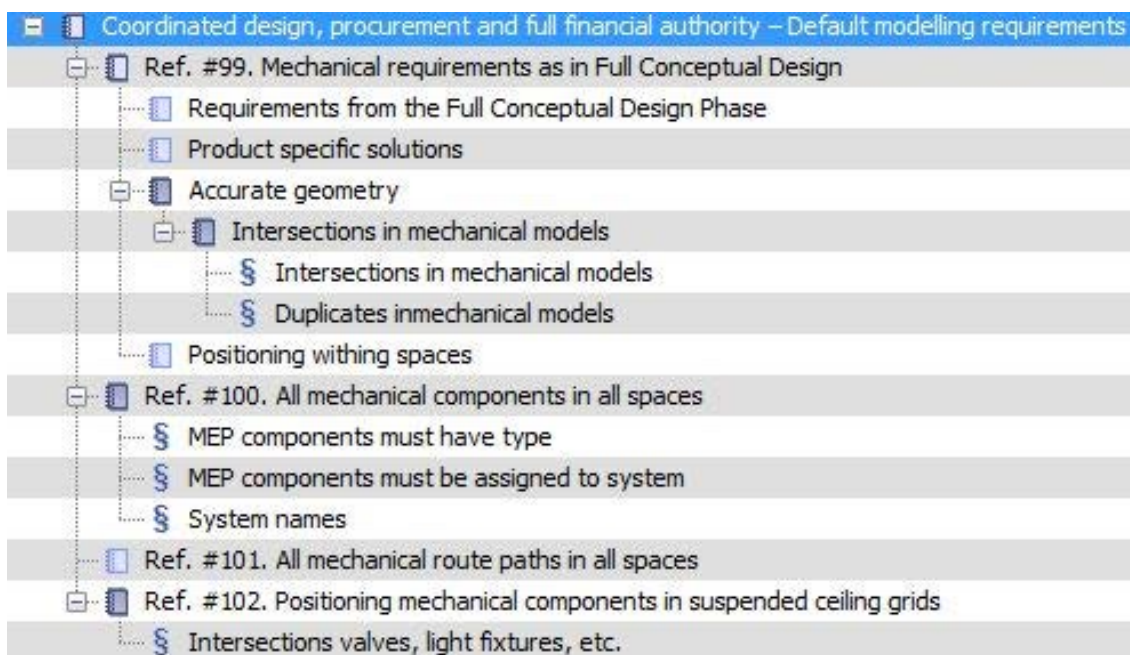

Figure 4.51. Rulesets of Statsbygg BIM Manual in Solibri Model Checker, C.6 Mechanical Engineering Modelling, Coordinated design, procurement and full financial authority – Default modelling requirements.

Paragraph C.7 deals with Electrical and Communications Engineering Modelling and it is divided in three parts. The first, Outline Conceptual Design – Default modelling requirements, includes *Ref. #103*. Spaces –technical spaces, shafts, external cable traces (culverts), etc., *Ref. #104*. Entry points for technical infrastructure, *Ref. #105*. Major electrical and communications components and *Ref. #106*. Main electrical and communications system components at critical locations (Figure 4.52).

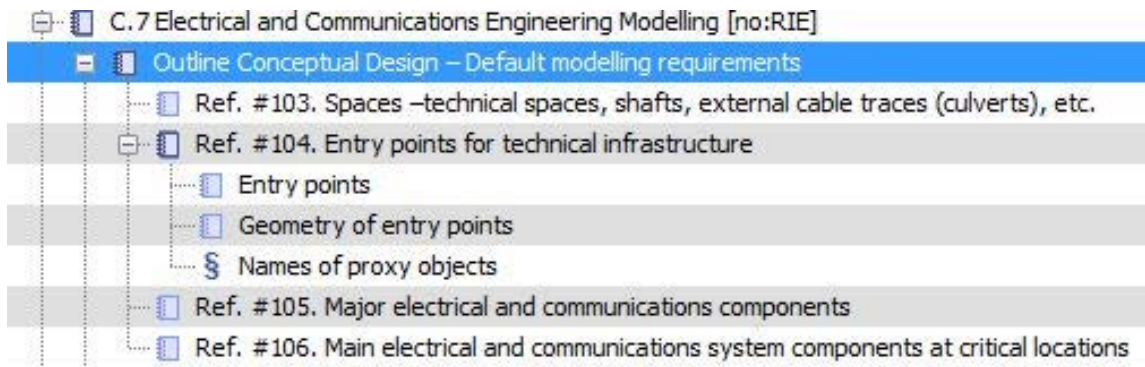

Figure 4.52. Rulesets of Statsbygg BIM Manual in Solibri Model Checker, C.7 Electrical and Communications Engineering Modelling, Outline Conceptual Design – Default modelling requirements.

All these requirements need a manual check, except the control of the name scheme of *Ref. #104*.

The second part, Full Conceptual Design – Default modelling requirements, comprehends *Ref. #107*. Electrical and communications requirements as in Outline Conceptual Design, *Ref. #108*. All electrical and communications components in technical spaces, shafts, external pipe/duct traces (culverts), etc., *Ref. #109*. All electrical and communications components in defined ‘special’ spaces and *Ref. #110*. All electrical and communications components in defined ‘type room’ spaces. There are two rules to validate the accuracy of the geometry (*Ref. #107*). Moreover, there are rulesets to check if electrical components have a type, if all objects are assigned to relevant systems and if the naming of systems is correct (*Ref. #108*). On the other hand there are no rulesets useful to validate *Ref. #109*. and *Ref. #110*. (Figure 4.53).

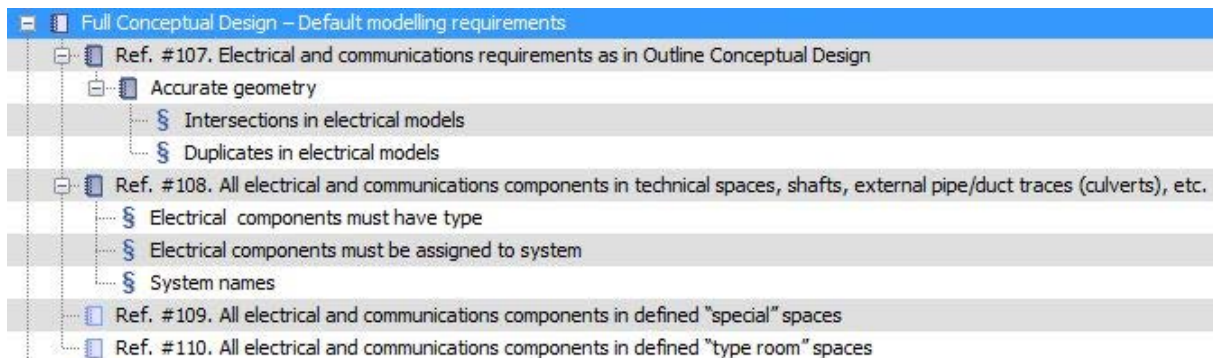

Figure 4.53. Rulesets of Statsbygg BIM Manual in Solibri Model Checker, C.7 Electrical and Communications Engineering Modelling, Full Conceptual Design – Default modelling requirements.

The last part of paragraph C.7, Coordinated design, procurement and full financial authority – Default modelling requirements, includes *Ref. #111*. Electrical and communications requirements as in Full Conceptual Design, *Ref. #112*. All electrical and communications components in all spaces, *Ref. #113*. All electrical and communications route paths in all spaces and *Ref. #114*. Positioning electrical and communications components in suspended ceiling grids. Also in this case *Ref. #111*. needs the re-

requirements of the previous part as a basis, but it is not possible to check it automatically. Moreover, SMC does not include rulesets for checking the level of detail of components and the precise position within spaces for relevant electrical and communications equipment. However, there are similar rules for the accuracy of the geometry (such as for Ref. #95. and Ref. #99). The requirement Ref. #112. can be validated thanks to a rule which checks the correct type of components. SMC, instead, does not allow the automatic control of Ref. #113., but the same rule as for Ref. #102. can be used for Ref. #114. to control the intersections between components in HVAC models (Ref. #102.) (Figure 4.54).

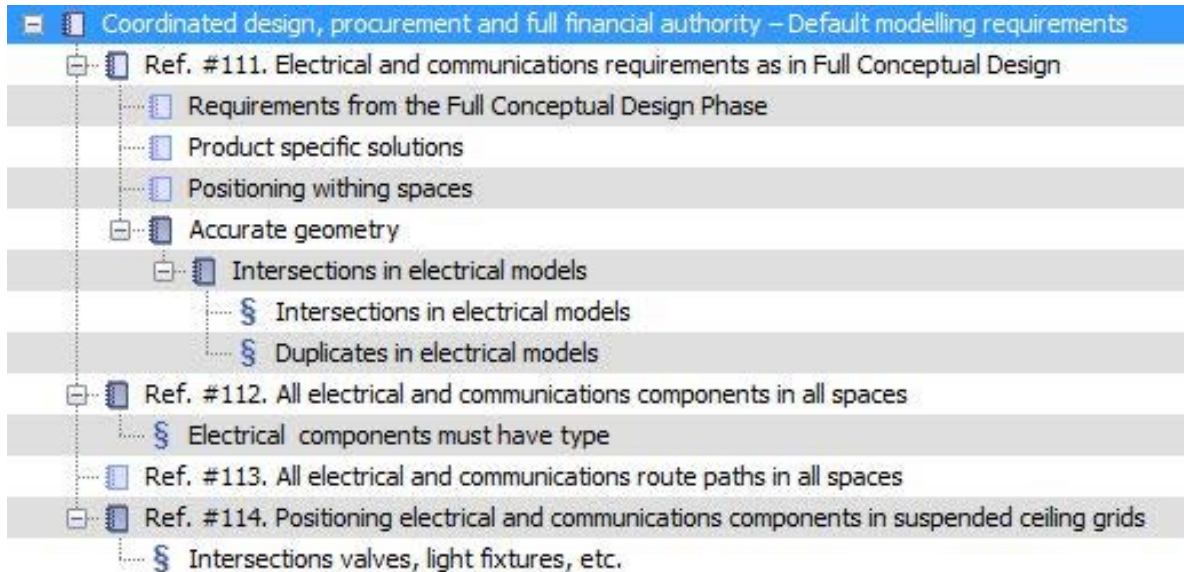

Figure 4.54. Rulesets of Statsbygg BIM Manual in Solibri Model Checker, C.7 Electrical and Communications Engineering Modelling, Coordinated design, procurement and full financial authority – Default modelling requirements.

Paragraph C.8 is related to Acoustical Engineering Modelling and it is divided in three parts (Figure 4.55).

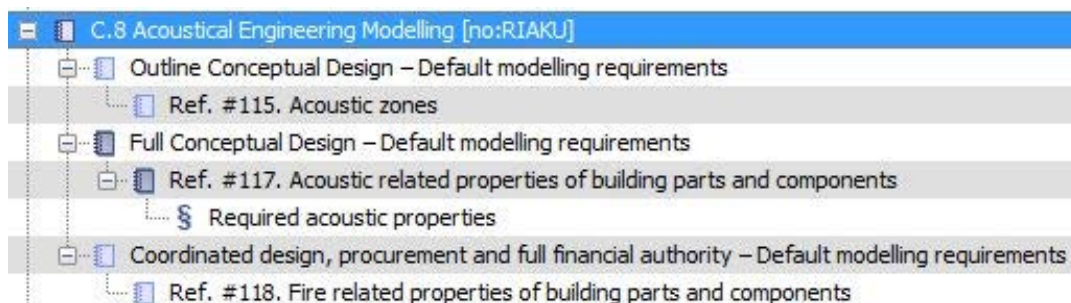

Figure 4.55. Rulesets of Statsbygg BIM Manual in Solibri Model Checker, C.8 Acoustical Engineering Modelling.

The first, Outline Conceptual Design – Default modelling requirements, includes Ref. #115. Acoustic zones and Ref. #116. Simplified geometry models for selected space areas, but both of them have not been translated in SMC. The second part, Full Con-

ceptual Design – Default modelling requirements, contains only one requirement *Ref. #117*. Acoustic related properties of building parts and components and in SMC there is the rule § *Required acoustic properties* for this aim. Finally, the last part, Coordinated design, procurement and full financial authority – Default modelling requirements, includes only *Ref. #118*. Fire related properties of building parts and components, but there is not any ruleset available.

The last paragraph of SBM1.2 in SMC is C.9 Fire Safety Engineering Modelling and it is divided in three parts (Figure 4.56).

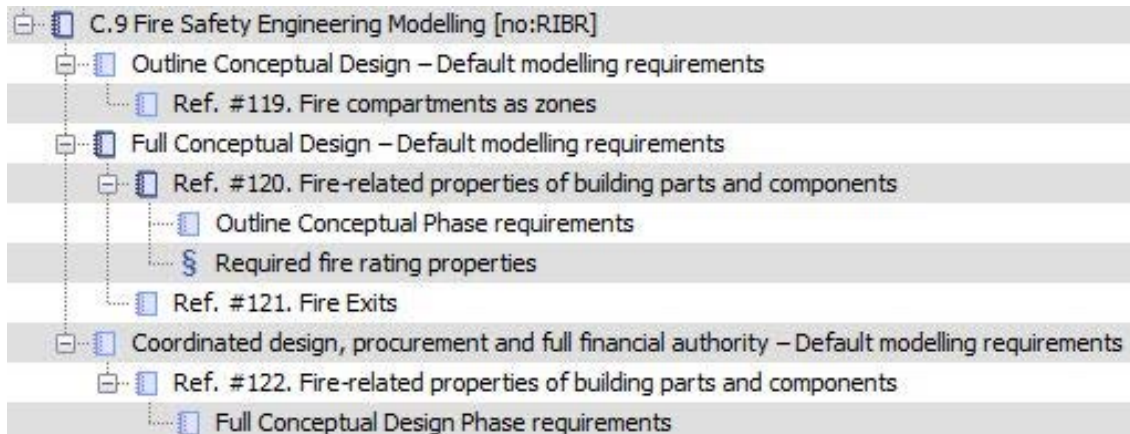

Figure 4.56. Rulesets of Statsbygg BIM Manual in Solibri Model Checker, C.9 Fire Safety Engineering Modelling.

The first, Outline Conceptual Design – Default modelling requirements, includes *Ref. #119*. Fire compartments as zones, but it has not been translated in SMC. The second part, Full Conceptual Design – Default modelling requirements, contains *Ref. #120*. Fire-related properties of building parts and components and *Ref. #121*. Fire Exits. In SMC there is the rule § *Required fire rating properties* for the first requirement but none for the second. Finally, the last part, Coordinated design, procurement and full financial authority – Default modelling requirements, includes *Ref. #122*. Fire-related properties of building parts and components and *Ref. #123*. Sprinkler protection coverage, but there is not any ruleset available.

4.4.6 Limitations and Possibilities

Currently the implementation of clash detection for assessment of model quality is common among professionals in the AEC industry (Hjelseth, 2012, p. 461); moreover, the development of automated rule checking is increasing especially for building code and accessibility criteria (Eastman, Lee, Jeong, and Lee, 2009; Greenwood, Lockley, Malsane and Matthews, 2010). The implementation of a BIM-based model checking approach could benefit in terms of faster and more reliable checking of compliance with regulations (Eastman, Lee, Jeong, and Lee, 2009). This process can be used also to evaluate design proposals when BIM is required. Some requirements included in the tender documentation are easy to be checked (e.g. dimension of spaces or properties of elements), instead others are more difficult because they are more subjective (e.g. evaluate the townscape and architectonic quality, find solutions to open out to as many

views as possible of the surrounding landscape, the access to views, provide sense of equality between different work places, the adaptability or the integration of spaces, the optimal location of different spaces, the optimal position of systems/elements in relation to efficiency and maintenance such as solar cells or solar protection solutions). For this reason, if the issues to be checked are quite simple e.g. control agreed space names, it is very easy to check if they are in compliance or not with the requirements, because the reply can be 'Yes' or 'No'. Therefore, in these cases the process can be automated, but there are still other cases in which experienced people are required to say if something is acceptable or not.

Eastman, Lee, Jeong, and Lee (2009) in their paper affirm the need to implement different rulesets for all buildings (at the national, regional or municipal level of organisation), for specific building types (e.g. based on design guides of best practice) and for specific building projects (programmatic requirements which may be developed by the client). The latter level is the one that should be included in the tender documentation of each project. The implementation of rulesets is of course a big effort because automated compliance checking requires the application of software tools which are normally generic and international, instead codes and regulations are specific and local (e.g. different way to measure in different cities) (Greenwood, Lockley, Malsane and Matthews, 2010). For this reason software, such as SMC, must be flexible enough to cover all the possibilities, but at the same time the rules are so rich in parameters that the users have more difficulties managing them. Another obstacle in the rule based approach is the interpretation of rules and regulations, which have been written by people and for a long time, have been read and applied only by people (Eastman, Lee, Jeong, and Lee, 2009, p. 1013). As a result, usually they are contradictory and cryptic and their interpretation is not always univocal; this fact is a problem for the rule based implementation which is for its nature a transparent and objective process.

In paragraph 4.4.4 an illustration of the main client's requirement which can be checked from a BIM, has been provided. It is clear that nowadays the majority of the client's BIM requirements presented in the paragraph 4.4.2 are possible to be checked using SMC and other commercial software. However, SMC does not allow the possibility to compare two different models, for this reason it is better to give points outside SMC (e.g. in excel) to obtain a final calculation. It is possible to automatically receive reports of the results of the checks, paying attention to the origin of the data. For example SMC can generate reports of how many accepted/critical issues there are, how many components have been checked, how many have been passed/failed and outside SMC it is possible to compare different reports manually (e.g. in excel the jury can compare the amount of critical issues to the total volume of the model or of the gross area or the failed components to the total checked ones. It is also possible to edit the excel sheet adding a column for specific coefficients).

Moreover, the example presented in paragraph 4.4.5, shows that most of the written requirements can be controlled using Model Checking software, such as SMC. However, for increased efficiency, all the mandatory requirements should be included in SMC and the requirements should be published taking into account an effective way to check them.

Future developments should incorporate model checking means within design software in order to immediately find conflicts and incoherencies, like the project under developing by the MIT Design and Computation Group of Massachusetts (Soto and

Carlsson, 2013). It would be useful if clients will provide rulesets to tenders and they will include them in the design software (such as Revit) to receive an immediate feedback about their work without export it in other software. For example if a ruleset mandates that there must be a precise quantity of free area in front of doors, the software will allow only to insert other components far from the doors of the quantity specified in the rule. This approach will help to transfer the 'knowledge', usually attributes to experts, to a software.

4.5 Examples of BIM adoption in Tendering

4.5.1 Introduction

In this paragraph five case studies presented in literature are shown in order to investigate the possible implementation of BIM in the Tender phase. The first three case studies are architectural design competitions where IFC files were required. The first case study deals with the modernisation of a cluster of University Buildings in Denmark (2005), the second with a National Museum at Vestbanen in Oslo (2009) and the third with a Synergy Building in Helsinki (2010). Later an innovate Canadian case study, concerning an Office and Shopping Space (2010), is shown and it presents the possible adoption of a new procurement method, the Early BIM Partnering, within public works (see paragraph 2.3.3 for more details). Also in the last case study of a prison in Rochester a new procurement method, Two Stage Open Book, is adopted. This paragraph concludes by discussing the main benefits and weak aspects of the case studies.

4.5.2 Architectural Competition: Aalborg University (Aalborg, Denmark)

Starting from 2007 the Danish government has decided to introduce a set of requirements for electronic communication and tendering through a web based document management system, adoption of 3D models and digitalization of operation and maintenance information. Requirements and guidelines were prepared to describe contents and levels of detail of 3D models. These requirements were tested for the first time in 2005 in an architectural competition for an overall plan to modernise a cluster of university buildings 30 years old (Svidt and Christiansson, 2008). The architectural competition was for only four pre-qualified competitors selected by the client, the public owner of Danish university buildings (Figure 4.57). The architects were asked to present a 3D model in IFC format and 3D visualisations, moreover, the client decided to avoid all paper based communications. For this reason the competitors received the tender documentation (including an IFC 3D model of the site and of all existent buildings) electronically and they were required to submit their proposal using the same document management system. To comply with the decision to eliminate the utilisation of papers, the jury decided to evaluate the proposals using a computer projector, without printing any posters. At the end of the competition all the parties involved were interviewed to identify the main benefits and problems encountered during the process.

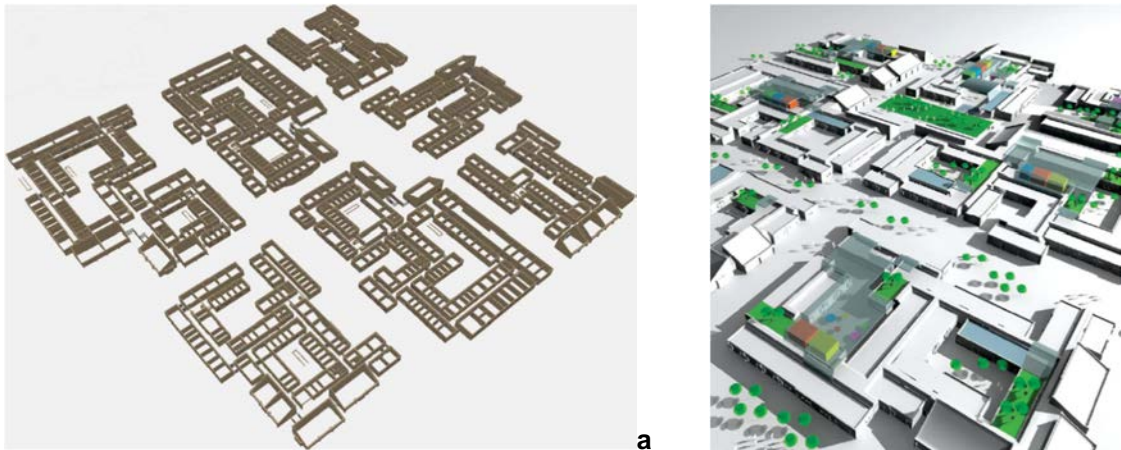

Figure 4.57. (a) 3D model of the cluster of university buildings (Svidt and Karlshøj, 2005) and (b) A proposal for modernising the cluster of university buildings (Svidt and Karlshøj, 2005).

The architects expressed that (Svidt and Christiansson, 2008):

- The requirements publications contained too many pages, they would prefer a shorter introduction;
- The 3D building model from the client helped them in the visualisation of the project;
- The 3D model they received had a lot of errors and a higher level of detail than they were supposed to provide for their proposal. For this reason they had some problems (e.g. complex wall objects made it complicated to manage simple operations such as inserting windows and doors);
- They had some initial difficulties in delivering IFC files and in importing 3D objects from other software;
- They found immediate advantages in using models, in particular for quantity take off even if they admitted that it required training to become competent to implement this technology;
- Working with 3D models in the sketching phase was more challenging than traditional 2D, and forced them to solve some issues, which would not have arisen using traditional sketching;
- It was their first pure digital delivery;
- It was not simple to change the working methods for someone who preferred to prepare the proposal in a traditional way making the 3D model only at the end.

The client, instead, admitted that (Svidt and Christiansson, 2008):

- The jury was able to focus on the same picture during the electronic presentation using a projector;
- Also the client's system needs new competences when 3D models are required;

- Thanks to the electronic delivery, it was possible to study the proposal before the first jury meeting;
- The jury was not able to navigate freely in the models because this was only an option and not a mandatory requirement;
- There were some viewing problems due to insufficient capacity of the computer adopted and insufficient quality level of the proposals for a project presentation.

4.5.3 Architectural Competition: National Museum (Oslo, Norway)

In 2009 the Ministry of Administration, Reform and Church Affairs commissioned Statsbygg to plan a new National Museum in the old Oslo West Railway Station called 'Vestbanen' and an Architectural competition in two phases was set up. Phase 1 was an open international competition, where nearly 1300 registrations were submitted on the competition web and 237 proposals were finally delivered to the model server (Figure 4.58a). Only six competitors were selected for Phase 2 and, at the end, the jury selected three winners, who were invited to participate in a negotiated design contract competition. This case study is relevant because the implementation of BIM was at the centre of the competition and it was used for an efficient evaluation and decision support to 'compare models in respect of their environmental and building in use solutions' (Kvarsvik, 2010b).

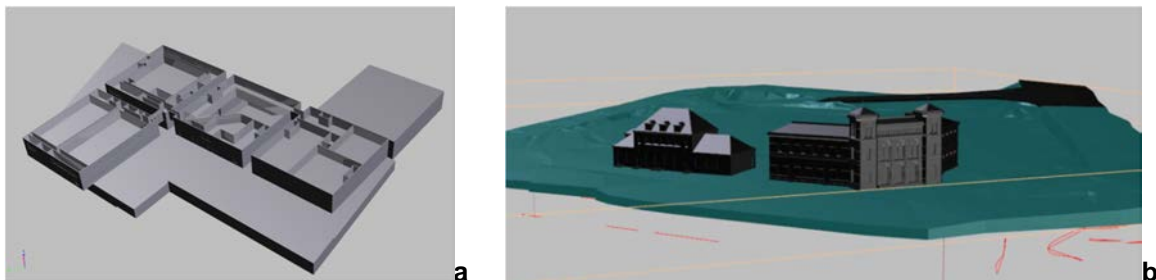

Figure 4.58. (a) Urban Transition's BIM model for Phase 1 and (b) BIM model of the competition area (Kvarsvik, 2010a). Available at <http://statsbygg.no/Utviklingsprosjekter/Nasjonalmuseet/Konkurransen/Fase-1/> (last visit 7 February 2013).

The first steps to prepare the tender documentation were the set of a simple BIM manual, later attached to the competition programme, the Appendix 5.6 Digital 3D model and BIM requirements (Statsbygg, 2010a), the test of the most likely architect CAD systems to check if they could be in compliance with the requirements, the preparation of guidelines for these CAD systems and the development of a Model Server Manager for receiving and analysing models (e.g. implementation of IFC in the Geographic Information System (GIS) viewer). Moreover, the competitors received a site object (Figure 4.58b), included existing buildings, in an openBIM format to set the local origin and orient models correctly (Kvarsvik, 2010a) and an IFC file of the functional zones with spaces representing sub functions (Figure 4.59).

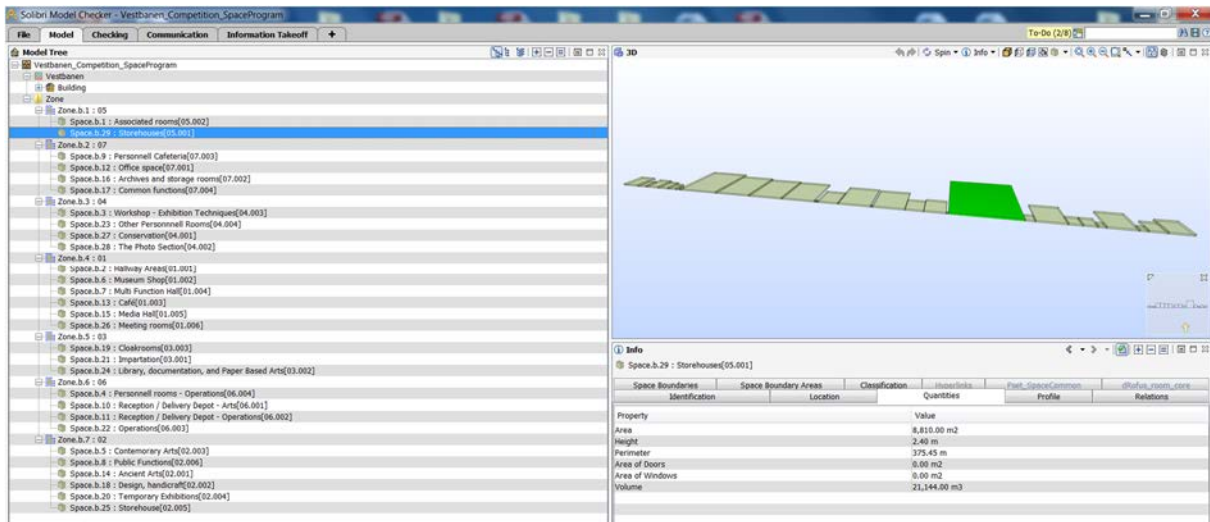

Figure 4.59. Space Programme of the Architectural Competition of the National Museum at Vestbanen.

BIM was especially used for visualisation, area quantities measurements and energy performance analysis. The main BIM tools used by the jury to select the six finalists in Phase 2 were (Kvarsvik, 2010b):

- *Model Server Manager* used to georeference the model and ensure its anonymity;
- *Solibri Model Checker* used to validate the building information models, area and volume quantity measurements, space heights and extraction of different Quantity Take Off (QTO) (related to Architectural components, security, costing and environment);
- *dRofus* used to compare requirements against the designed net functional area;
- *Calculus* used for cost calculations;
- *Riuska* used for energy analyses;
- *Xf+* used to import the model to GIS and display it in the terrain;
- *3DStudio* used to create videos of the models displayed in the terrain.

A customised version of the Jotne EPM Model Server Manager, the Vestbanen BIM Manager, was created and given to help the management of integrated database in an openBIM format during the architectural competition (Jonte EPM Tecnology, 2009). This tool made it possible to:

- Load and manage the IFC model files in Statsbygg's local database and competition store;
- Provide a validation function that:
 - Checked IFC format
 - Checked the correct geographical placement of buildings
 - Checked building objects classifications as internal or external
 - Audited building elements and spaces for clashes
 - Ensured all space names conform to the competition rules

- Checked if the external wall, door and window elements were correctly located and forming a consistent building envelope
- Calculated the area based on geometry, compared to the space programme
- Checked anonymity
- Generate the required reports for:
 - Space programme
 - Energy performance
- Generate visualisations from the three reference points;
- Provide a checklist prior to submitting models to ensure all tasks have passed the auditing;
- Allow the final submission (Jotne EPM Tecnology, 2009).

Moreover, Statsbygg used Proarc software, the 'BID Room' and the 'Evaluation Room' to manage the tender phase. This tool allows to track all the information related to the bid process (e.g. control who uploads and downloads documents, publish news, information, questions and answers, communicate with one or more bidders, receive bids). It was directly integrated with the BIM Platform EDM model Sever, so for the jury the evaluation of each proposal was easier thanks to advantaged 3D visualisation into area, volume, cost an energy performance reports (http://www.software-innovation.com/dk/produkter/ProArc/Documents/BID%20Room_PA_final_v2_dk.pdf. Last visit 24 July 2013).

Thanks to BIM, the jury was able to check and report the results better, furthermore the openBIM and Model Server technology gave added value for visualisation, area checks (net functional areas and volumes) and anonymity (e.g. to remove lfcOwnerHistory information) in Phase 1. In addition to these benefits, Statsbygg noted other potentialities in Phase 2 (Kvarsvik, 2010a):

- there were no limitations to allowed entities/object types;
- required naming conventions for identifying construction types (followed by a list with construction type details). This cataloguing was particularly useful for QTO, Costing and CO₂ emission calculation;
- energy analysis;
- analyse the organisation of the five different security zones in the project;
- net space height and occupancy state (regulations in Oslo municipality). In particular to check if one story was in accordance with the regulations maximum 4,9 m;
- MEP/technical spaces (and bounding box).

The jury was very surprised of the high-quality results using these BIM tools apart from Riuska, whose models were not detailed enough to yield significant reports (Kvarsvik, 2010b). In particular, the jury mentioned in its final report that 'models have been very useful in Phase 2 with regard to visualisation of the project and data extraction for calculations and controls in respect of the environment and economic considerations' (Statsbygg, 2010b, p. 8). Moreover, the jury declared it was simpler to compare the different design proposals imported in the same terrain, instead of evaluating photo-montages created by the architects, which can be manipulated and so the comparison becomes less objective. Ole Kristian Kvarsvik (2010b), Senior Engineer at Statsbygg at

that time, said that ‘without the use of BIM, it would simply not have been possible to review so many submissions at such professional levels’. The jury understood that requiring openBIM deliveries gives added value to the design evaluation and it realised the necessity of improving BIM requirements in subsequent architectural competitions because the Client was not completely aware of BIM potential (Kvarsvik, 2010b). Furthermore Kvarsvik (2010b) identified other obstacles related to the limitation in IFC export setup options, duplication occurs due to the complexity of the projects, the lack of experience in generating good models (the designers were still focused on producing good drawings) and lack of guidelines or manuals to support the interactions between software and designers.

4.5.4 Design Competition: Viikki Synergy Building (Helsinki, Finland)

In 2010 Senate Properties and the Finnish Environment Institute (SYKE) organized a competition for the design of the Finnish Environment Institute’s office building in the Viikki Science Park area of Helsinki, the most extensive and internationally significant concentration of research and expertise in the bioscience, environmental, and natural resource sciences sectors in Finland. Six design consultant companies, qualified not only in architecture but also in energy efficiency and ecological sustainability, were selected to be invited. They had to find an innovative solution to concentrate all the Institute’s operations under one roof, containing office premises for approximately 625 people as well as laboratory facilities. The aim of the competition was to develop ecologically sustainable building methods, paying attention to the building’s energy consumption and modifiability, to the indoor air quality, the healthiness of building materials, the local renewable energy production, as well as building serviceability and reparability. In fact the main goals were:

- Ecological sustainability (in order of importance):
 - Energy efficiency
 - Material efficiency and ecological sustainability
 - Local renewable energy production
 - Other (possible) solutions supporting ecological sustainability
- Townscape and architectonic quality:
 - Integration with the Viikki Science Park
 - Overall architectonic solution
 - Originality (interesting expression of environmental favourability)
- Usability:
 - Functional characteristics
 - Quality of working environment
- Feasibility:
 - Investment and life cycle costs
 - Quality of technical solutions.

More importance was given to the overall solution and the entry’s development potential than the flawlessness of details.

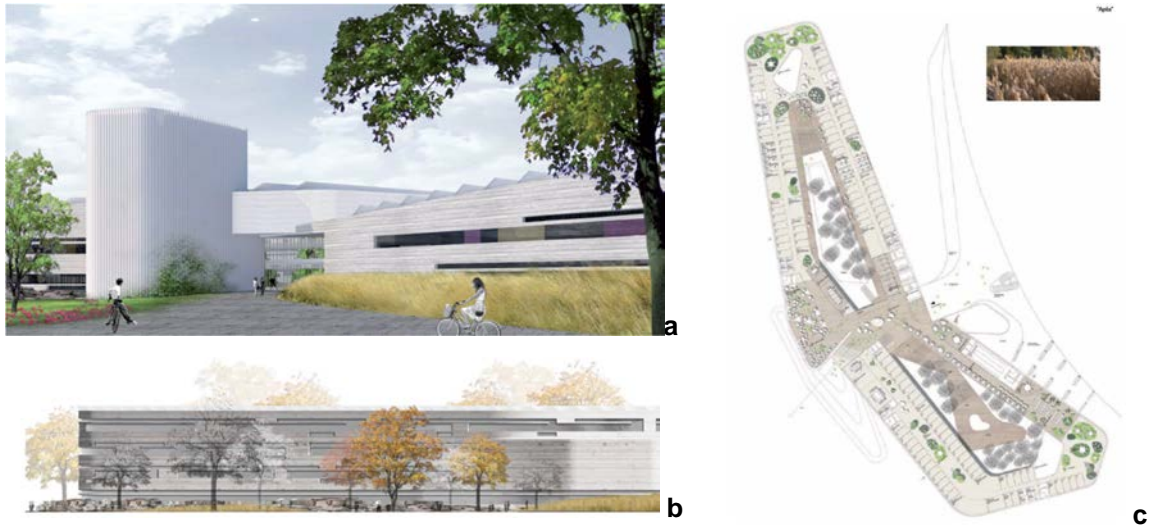

Figure 4.60. (a) Exterior perspective view (Senaatti and SYKE, 2010d), (b) Façade to the West (Senaatti and SYKE, 2010d) and (c) Plan of the competition winner 'Apila' (Senaatti and SYKE, 2010d).

Minimum requirements were presented in the contract notice of the competition and particular importance was given to the ability to adopt IFC files:

'The working group organized by the contracting party has the preparedness to function as part of a team exploiting data modelling in the competition stage as well as in the subsequent design stage. Compliance with Senate Properties data modelling requirements, found at the address: <http://www.senaatti.fi/document.asp?siteID=1&docID=546>, is mandatory. (Compliance with the instructions will ensure that the IFC file generated during the competition stage will be useable in energy and condition simulations, quantity calculations, and scope assessments)' (Senaatti and SYKE, 2010c).

Traditional tender documentation in .dwg and .pdf formats was provided to the competitors, indeed, contrary to the Architectural Competition for the National Museum at Vestbanen, only 2D drawings and a room programme in a .pdf version were published in the website of the competition.

The competitors were asked to present traditional documents in paper version, in addition to the .pdf or .jpg formats (e.g. 2D drawings of the site plan, floor plans, floor plan detail, façades and sections); however, a 'Building object's location's IFC model (IFC 2x3 version), indicating all of the building's external envelope structure, glazed construction, as well as the placement of room spaces / facilities' (Senaatti and SYKE, 2010a, p. 23) was also required. The IFC-model was used for checking simulations and calculations carried out by the organizer in connection with the assessment of the competition entries. During the entries assessment period, a representative of the competition's organizers was allowed to ask the competitors for corrections and adjustments to the models. Moreover, a 'quantity survey of construction (m² and kg) based on IFC model or other calculation method' was demanded (Senaatti and SYKE, 2010a, p. 24); this means that it was possible to utilise IFC models to calculate quantities but this method was not mandatory.

During the tender competitors had the opportunity to present in two instalments questions to the assessment group regarding the competition. During the first instalment a competitor asked more information about the level of detail of the IFC model, the required parameters for building elements and the possibility to utilise a data transfer to check the compatibility of the model. The Client replied that the requirements for the IFC model would have been obvious for the specialists of dimensional energy and condition simulation; however, they indicated the follow minimum requirements:

- The building envelope including:
 - Ground floor (types)
 - External wall (types)
 - Windows and glass walls (types)
 - Roof (types).
- Spaces (coded as in the room programme); it is important, that all the spaces are modelled as spaces
- Intermediate floors (types)
- Principal loadbearing structures (types)
- Principal channels and shafts.

In addition, only IFC models in version 2x3 were accepted in order to compare the proposals equally as already expressed in the competition programme. Finally, the Client gave the possibility to send models to be tested before the final submission by email (Senaatti and SYKE, 2010b, p. 10).

The competitors were not asked to provide model specifications, however, only the winner, the entry 'Apila' (Figure 4.60), whose authors were JKMM Architects and ECAD (East China Architectural Design & Research Institute Co., Ltd), presented a short description of the modelled parts of the building. Furthermore they declared the utility of the IFC model for the quantity take-off of some elements (e.g. façades, windows, roof), even if a traditional method was still adopted to calculate quantities of load bearing structures (e.g. columns, beams, foundations and piles) (Apila, 2010).

4.5.5 Early BIM Partnering: Office and Shopping Space (Canada)

In 2013 two Canadian researchers published a report (Porwal and Hewage, 2013) about a case study where the feasibility of the Early BIM partnering project delivery approach was explored. The public project was originally planned to utilise traditional Design-Bid-Build with low bid procurement. As already presented in paragraph 2.3.3, this delivery method consists of five phases:

1. Planning phase
2. Modelling phase
3. Partnering award phase
4. Early BIM partnering phase
5. Construction award.

The case study was applied on an Office and Shop Space project of a new building (five storeys totalling around 14,000 m² floor areas) and it started in October 2010. The architectural design firm involved had a previous basic experience of using BIM mainly

for 3D visualisations. A standard 'Submission of Qualification' was used to select the general contractor, without limiting the number of bidders. The principal evaluation criteria regarded the ability to deliver the construction project and focused on elements such as specialized expertise, technical staff resources and relevant work experience subjected to reference checks; finally the winner was qualified on the lowest offer.

An integrated 3D model (using Revit Architecture) was provided to the tenderers for a better visualisation of the project and for pricing purposes. Unfortunately it was not included in the contract form, although the authors hope for a future official inclusion of the model in the contract document. Due to lack of trust on completeness and accuracy of BIM tools, there was not a total BIM approach to the project because the Architect provided 2D drawings using AutoCAD and later the design team coordinated the documentation into the Building Information Model. The following modelling tools from Autodesk were taken into use to facilitate the exchange of data and the transition from CAD to BIM process, because nowadays the construction industry mostly utilises the AutoCAD platform with .dwg file format:

Architecture	Revit Architecture
Structural	Revit Structure
Mech/Elect/Plum	Revit MEP
Costing	Quantity Takeoff
Clash Detection	Navisworks
Performance Analysis	Ecotect Analysis

A level of detail (LOD) variable from 200 to 300 was used to keep the file size smaller and the modelling workflow faster. In addition to fulfil this aim only typical floors were detailed, it relied on 2D line work for detailing anything over 1:40 scale drawing and different LOD were used for different purposes (e.g. Architectural detailing was done up to LOD 300). There was not only a unique model but the main one was used to generate accurate and integrated 2D documentation, for clash detection and for collaboration between different parts, in addition, other models were generated for high-end rendering. Parts of the main model were extracted in 2D drawings to create details in smaller scales. The Architectural Model was used to evaluate different options in the early design concept by performing analysis and daylight simulations (Figure 4.61).

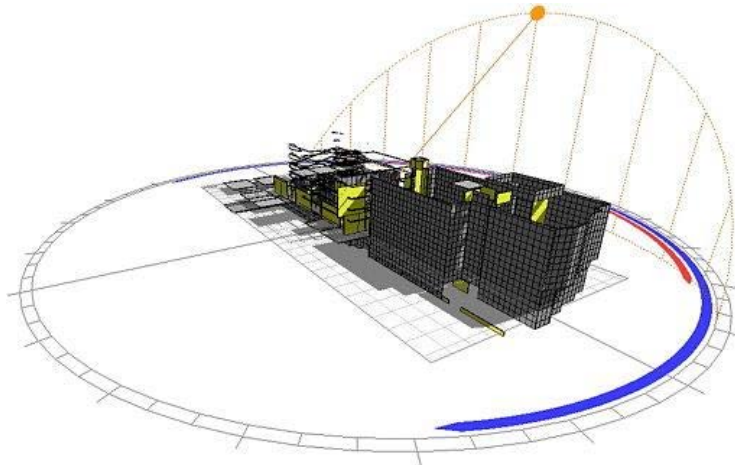

Figure 4.61. Monthly average solar irradiance on the different surfaces using IFC data. (Porwal and Hewage, 2013, p. 212).

The model created by the general consultant was adjusted in a later phase, but not re-created. It was useful for the structural and MEP engineers. MEP information was first documented in 2D CAD and then modelled in 3D using the 2D drawings as an underlay. Finally, the architect linked both the Structural and the MEP models into the architectural one to create a 'Full Design Model' and clashes were identified using Navisworks (e.g. the floor height was increased due to lack of space to accommodate HVAC systems). At the end of the simulation, the efficiency of the BIM partnering process was measured taking into account the hours spent by the design team to prepare BIM models and to coordinate, the ability of the staff to handle new technology implementations, the requirements of new hardware and software and the accuracy of 2D documents extracted from the Building Information Model.

The main results identified by the authors were (Porwal and Hewage, 2013, p. 212):

- The cost planners indicated that they require much more details in the Schematic Design Stage, if they are to fully benefit from the Building Information Model. Cost planners could not rely heavily on the model. There is a risk that some building objects may not completely be modelled and so not counted.
- It was noted that BIM-Partnering minimised the role traditionally played by the structural engineer on such projects, and brought the steel detailers closer to being part of the project's design team.
- The 2D documents, exported from 'Full Design Model', were of equivalent quality to that of the traditional CAD working drawings.
- BIM-Partnering provided a forum to bring the different players of the AEC industry together to address project-wide collaboration.
- BIM-Partnering helped the project team to manage client involvement by creating a coordination platform. It was aligned with the government procedures and rules.
- Owner, owner's designer, and the general contractor could contribute to the need of hardware and software requirements. One high capacity computer as 'server' with four moderate configuration computers was found sufficient as most of the design team members were equipped with their own desktops and laptops.

Moreover, contract administration members and team staff involved in the process were interviewed and the feedback suggested that the proposed BIM-Partnering procurement framework is appropriate for the public sector since the selection process is just as open, fair, objective, cost-effective and free of political influence, as the traditional competitive bid method. It provides equal opportunity to every qualified firm to compete for work with innovation and flexibility.

Thanks to model analysis a significant improvement in the cost, value, and carbon performance can be achieved in public construction projects with early contractor involvement in the design phase. Another positive aspect is that no additional design risks are assumed by the general contractor or subcontractor and this method establishes a balance between the complete control of the owner to choose the most favoured contractor and the owner's complete lack of control in the lowest tender price approach.

The following image shows the main differences between the DBB and the BIM Partnering project delivery methods (Figure 4.62).

BIM partnering v/s traditional procurement.

	Traditional D-B-B	BIM-Partnering
<i>1) Hiring of design consultant:</i>		
Selection method	<ul style="list-style-type: none"> • Direct selection • Qualification based selection 	<ul style="list-style-type: none"> • Qualification based selection
Design approach	<ul style="list-style-type: none"> • 2D CAD 	<ul style="list-style-type: none"> • 2D-3D, BIM
<i>2) Preparation of tender documents:</i>		
Drawings	<ul style="list-style-type: none"> • 2D designs 	<ul style="list-style-type: none"> • 2D designs • BIM
Cost estimation	<ul style="list-style-type: none"> • Substantive (class B) using 2D drawings 	<ul style="list-style-type: none"> • Substantive (class B) using 2D design/BIM
Level of designs	<ul style="list-style-type: none"> • 2D detailed design 	<ul style="list-style-type: none"> • Tender: 2D detailed design & BIM (level 200) • Construction: BIM (level 300+)
<i>3) Contractor selection:</i>		
Method	<ul style="list-style-type: none"> • Open tender/pre-qualified • Lowest bidder 	<ul style="list-style-type: none"> • Pre-qualified • Lowest bidder
Evaluation criteria	<ul style="list-style-type: none"> • Qualified A/E 	<ul style="list-style-type: none"> • BIM capable A/E/sub-contractors
Contract award	<ul style="list-style-type: none"> • One step – construction award 	<ul style="list-style-type: none"> • Step 1 – partnering award • Step 2 – construction award
<i>4) Contractor's involvement</i>		
	<ul style="list-style-type: none"> • During construction 	<ul style="list-style-type: none"> • During design and create BIM (level 300+) • During construction

Figure 4.62. Comparison between traditional DBB and BIM Partnering methods (Porwal and Hewage, 2013, p. 212).

4.5.6 Two Stage Open Book: Cookham Wood (Rochester, UK)

In March 2011 the UK Ministry of Justice started the project of a new build (Figure 4.63) 178-person Housing Block and an Education Block for the Youth Justice Board within the existing HM Young Offenders Institution Cookham Wood in Rochester (HM Government, 2013, p. 2). This project is one of the six projects of the Trial Projects Programme of the Government Construction Strategy (Cabinet Office, 2012, pp. 7–8), which wants to change the relationships between clients and the entire supply chain (HM Government, 2013, p. 5). The Ministry of Justice adopted one of the three new procurement methods, the Two Stage Open Book (see paragraph 2.4.5), which creates a collaborative culture so as to involve the consultants, Tier 1 and Tier 2 contractors at the earlier stage to develop together the project. In this way cost savings and efficiency are reached prior to start the construction on site. Another important innovation is the adoption of BIM, Government Soft Landings (see the UK presentation in paragraph 3.5.2) and Project Bank Accounts (HM Government, 2013, p. 1). Project Bank Accounts is also part of the Government Construction Strategy and it deals with a new way of paying supply chain members. Indeed, they will receive payment in five days or less from the due date, so this method assures certainty and security of payment and that it is made promptly (Cabinet Office, 2012c).

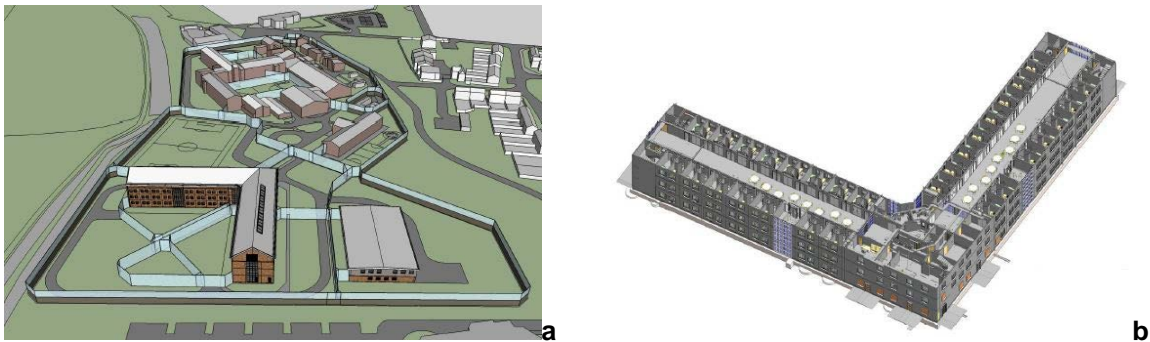

Figure 4.63. (a) 3D model of the surrounding area of Cookham Wood Youth Justice Board (BIM Task Group, 2013a) and (b) 3D model of the Cookham Wood Youth Justice Board New Build Young Offenders Institution (BIM Task Group, 2013b, p. 3).

First a BIM model was prepared from the existing 2D schemes by the Project Team for tender purposes; the tender documentation included the native BIM model, a COBie data drop and 2D drawings extracted from the model (BIM Task Group, 2013b, p. 2). The tenderers were invited to a pre tender BIM workshop at the Ministry of Justice to get familiar with the tender process adopting a BIM workflow (BIM Task Group, 2013b, p. 2).

During the tender period the client helped the bidders for example to extract COBie data, and at the end they were asked to submit their bid, a copy of the native model, a COBie data drop and 2D extracted from the model in PDF format (BIM Task Group, 2013b, p. 2). After that the client selected the main contractor, Interserve (HM Government, 2013, p. 2). The PPC2000 Project Partnering Agreement (with minimum amendments) was adopted to govern agreed timetabled preconstruction activities and the integrated team worked in preconstruction phase. Later they agreed on the maximum price and the contract was awarded (HM Government, 2013, p. 2). The construction started in November 2012 and the estimated completion is by November 2013

(BIM Task Group, 2013b). Thanks to a collaborative workflow, the client was able to control if the proposed solutions were in compliance with their specification. The PPC2000 standard form of contract, a single multiparty contract with two stages structure, fixed the Early Contractor Involvement of the Two Stage Open Book process. Moreover, Two Stage Open Book under PPC2000 generated a culture of collaboration throughout the integrated team not only during the preconstruction phase but also during the construction in order to improve both project delivery and prospective asset performance (HM Government, 2013, p. 3).

Some of the main benefits were (HM Government, 2013, pp. 2–3):

- Cost savings achieved to date are approximately 20%;
- Time savings;
- Programme certainty innovation and reduced prospective operating costs;
- Cost Collaborative working by integrated team.

Indeed, the Ministry of Justice set ‘a cost saving of 20% from the rate of £2,910 per square metre anticipated for a comparable project and the rate of £2,332 per square metre achieved in relation to Cookham Wood by the time of establishing the agreed maximum price’ (HM Government, 2013, p. 3). This result was reached thanks to innovation through collaborative engagement by all parties involved in the project and thanks to the BIM adoption (HM Government, 2013, pp. 3–4). 3D helped to demonstrate the impact of the proposal on the public realm surrounding the site, especially to local residents and the Planning Authority (BIM Task Group, 2013a). BIM improved the design coordination, it gave the possibility to walk through the building and find potential defects and clashes. It also facilitates the design review meeting. Additionally 4D and 5D simulations were helpful and COBie will provide useful data for the FM (HM Government, 2013, p. 3).

Interesting feedbacks related to the pre tender stage were (BIM Task Group, 2013a, pp. 4–7):

- In order to incorporate BIM, the client’s requirements and processes have to be carefully understood. Indeed, the client needs to define what level of information is required at each stage of the procurement process in general, but particularly during the tender phase to include BIM requirements.
- There is huge benefit to be gained from the Building Information Model for visualisation and client understanding, for this reason the Clients Information Requirements must be reviewed to more efficiently fit the BIM process.
- The BIM adoption is hampered by Ministry of Justice’s security requirements, so a security strategy for working with BIM must be defined.
- Software specification needs to be defined well in advance of production information being required. Indeed, the client should define design Team and Consultant Brief concerning BIM inputs and outputs.
- Tendering processes need to be revised and redefined to incorporate BIM, taking into account cost and carbon data.
- To hand down the work, knowledge must be transferred into the libraries so the library technical requirement needs to be understood quickly.

- There was poor understanding of how to achieve economical utilization of the Building Information Model and change control so the procedures need to be documented.
- There was a disconnection between essential paper-based information and BIM information. For this reason a definition of how to put a performance specification into a model needs to be defined as part of the library project.
- The tolerance strategy must be drawn up for each stage of the project with regard to acceptable number of clashes highlighted in the Building Information Model.
- The creation of COBie validation tools needs to be undertaken because a text description of the COBie data file cannot be electronically tested.
- BIM changes the way that the client operates its projects so the client has to define internal governance process for BIM projects.
- Tender processes need updating to cater for BIM processes so the tender document amendments must be reviewed once evaluation and moderation are complete.
- The restrictions of the client's IT systems hampered the ability to utilise BIM data effectively so the client has to define how to manage data and what platform to be used.
- The Pre-Tender BIM engagement workshops were very useful. So they should be utilised on all BIM tenders until the process and experience is fully developed.
- Due to novelty of tendering in a BIM format, the Constructors need to manage the process differently and use different resources so there is the need to be more forward planning and adherence to dates.
- Tenders are a critical stage of the life of the project and they need to be as effective as possible. For this reason development of BIM tender process and communication amongst Constructors should be developed across all Framework Constructors.
- The Level of Detail of information to be issued at tender stage needs to be developed to suit the specific project needs.
- An Effective adoption of BIM may need a review of the procurement process. Because BIM has the potential to change how designs are managed and risk profile so this may lead to review the tender process as BIM maturity increases.
- The Design Consultants working with the Constructor advised that they had never previously picked up BIM models developed by others to be worked upon.
- As a general comment based on current BIM process, technology and experience, six weeks for the tender period was seen to be too short by the Constructors. Indeed, the short tender period does not allow a fully integrated design development. Eventually, BIM will enhance the efficiency of the tender period but at present there is a learning and development phase to go through.
- The majority of the tender was administered by the Constructors using the 2D information (particularly amongst their supply chain) but this behaviour must change.

- A specific client's BIM Protocol document would help to consolidate some of the contractual issues around design responsibility for the BIM information. For this reason it should be part of the client's Standard Contract Forms.
- Constructors are keen to engage through the adoption of pre-tender workshops and BIM Special Interest Group.

It is notable to underline that this paragraph related to the Cookham Wood case study has been revised by Bill Davis, Principal Project Sponsor at UK Ministry of Justice.

4.5.7 Discussion

Each case study shows both innovative aspects and weak points. The Danish design competition is very innovative concerning the decision to avoid all paper-based communications indeed, the delivery of the tender documentation and the final evaluation were carried out using electronic technologies. When a 3D model has been provided to the tenderers (Danish, Canadian and English cases), it helped the visualisation of the project and the quantity take-off (useful also for pricing purposes in the Canadian case). However, the implementation of BIM in the Aalborg University was not optimal due to the lack of experience in adopting BIM tools and in the preparation of the tender requirements.

The Norwegian case study is innovative concerning the set of tender documentation and the will to implement BIM tools to evaluate the proposals. However, the client was not completely aware of the BIM potentialities and additional experience is required to improve the process. In the Finnish case, instead, BIM was used mostly for evaluating the ecological sustainability and less importance was given to the tender documentation. Indeed, the competitors received only traditional materials and they were asked to present an IFC-model as well as traditional documents. Unfortunately, there is only little information related to the Canadian case but the integration of BIM seems to give value added to the process, in particular in the tender phase where the bidding principle of openness, accountability and fairness were emphasised. Also the English case is very innovative thanks to the BIM integration, the Soft Landings strategy and the early involvement of the Contractor. These new procurement methods seems to be the most suitable for the BIM implementation because all parties involved can give a contribution also during the tender stage. Even if all these case studies obtained benefits by implementing BIM, improvements would need to be made to prepare more accurate tender documentation. In fact, from the beginning the public client needs to have clearer ideas about their objectives in order to implement BIM in a more efficiently. If the aims are clear and the client is aware of what they can obtain, it is possible to achieve more benefits using BIM and, in particular, to evaluate the proposals. Finally, further work is needed in the legal framework and in the project contractual issues.

4.6 Case Study: Galli Theatre (Rimini, Italy)

4.6.1 Introduction

This paragraph presents the possible implementation of BIM in the tender phase of a public procurement of an Italian theatre in Rimini. The public contact notice deals with the reconstruction works of the historical theatre Galli, placed in one of the most important squares of the city. It is a Design-Bid-Built procurement carried out in a tradi-

tional way. Indeed, the client published the call for tender in June 2011 and they provided all the drawings and the documentation in (2D) .pdf format to the bidders, publishing them in their website (http://www.comune.rimini.it/servizi/gare_appalti/-lav_publici/pagina381.html). Last visit 18 November 2012). The client adopted the most economically advantageous tender criterion and, even if it was a DBB procurement, the bidders were allowed to present possible improvements for the mechanical, fire, electrical and special systems and for the construction site layout. The deadline to present offers was in December 2011, until now the client selected the winner contractor and the construction phase will start during autumn 2013.

This paragraph describes how BIM could have been adopted to support the selection of the contractor concerning the bidders' proposals. Moreover, a simulation of this procurement has been carried out testing the Italian i-Faber e-Procurement platform for public administration, in order to understand its benefits and barriers and the integration of BIM within e-Procurement. The interface of i-Faber platform is in Italian, so the images related to this part are in Italian and a short description of the content has been provided in English.

4.6.2 Bidders' proposals

Even if this procurement was a DBB one, the bidders were allowed to present different site layout plans and improvements for the mechanical, fire, electrical and special systems. First, two possible solution of site layout plans were modelled in Autodesk Revit and later they were checked in Solibri Model Checker (SMC) to prove the utility of this tool in the evaluation of bids. Thanks to the 3D models, the jury can better visualise and understand the proposals. However, BIM is not only a simple 3D, but it contains data which can be utilised to check the conformity of requirements.

The site layout plans show the construction site area with buildings and temporary construction site equipment, such as the crane, scaffoldings, freight elevator, fences, pedestrian and vehicular gates, garbage bins, site office and security office. The 3D visualisation efficiently helps to find risk area and to manage the site layout plan, e.g. the crane extension area identifies the connecting street area and other building which could be influenced during the construction work (COBIM, 2012, Series 13, pp. 13–14). Moreover, it shows the impact of the construction on the surrounding area (Figure 4.64 and Figure 4.65).



Figure 4.64. View of the current status of the theatre Galli in Rimini.



Figure 4.65. Rendering of the client's site layout.

The public client provided only the 2D site layout plan (Figure 4.66) which simultaneously represents two phases of development. Indeed, in the first phase the client suggests a smaller site layout (Figure 4.67a), which will increase in a second phase where there will be other equipment such as the crane and site offices (Figure 4.67b).

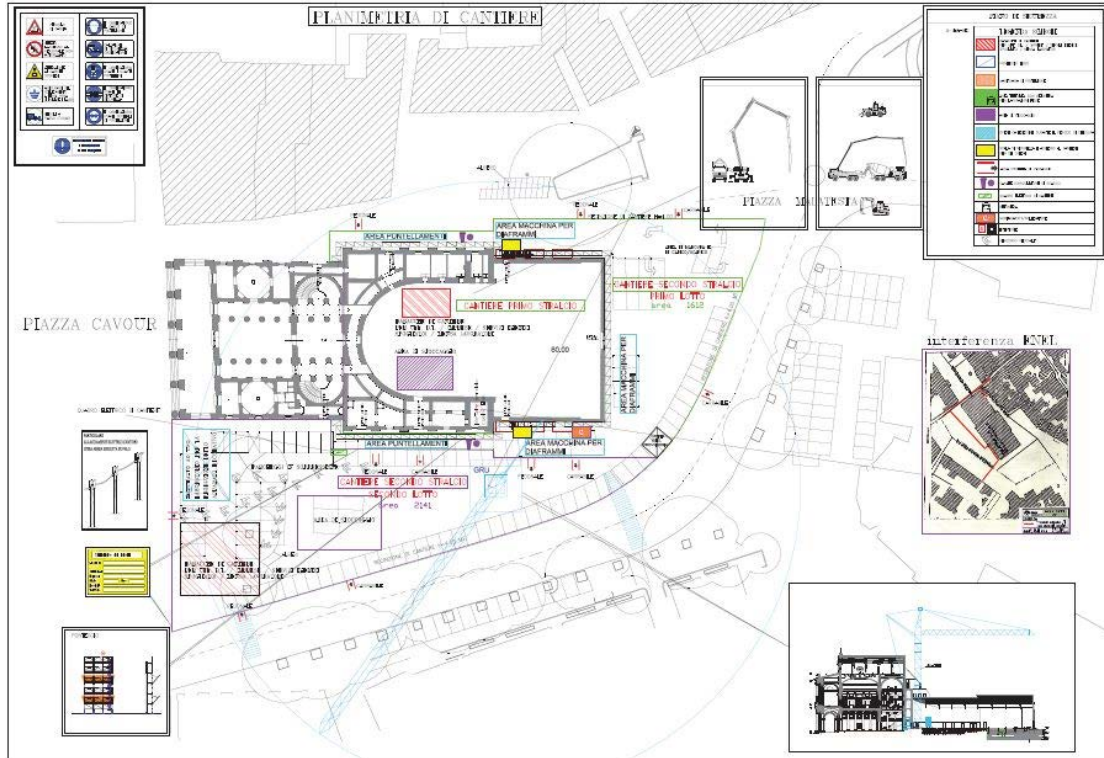

Figure 4.66. 2D client's site layout plan.

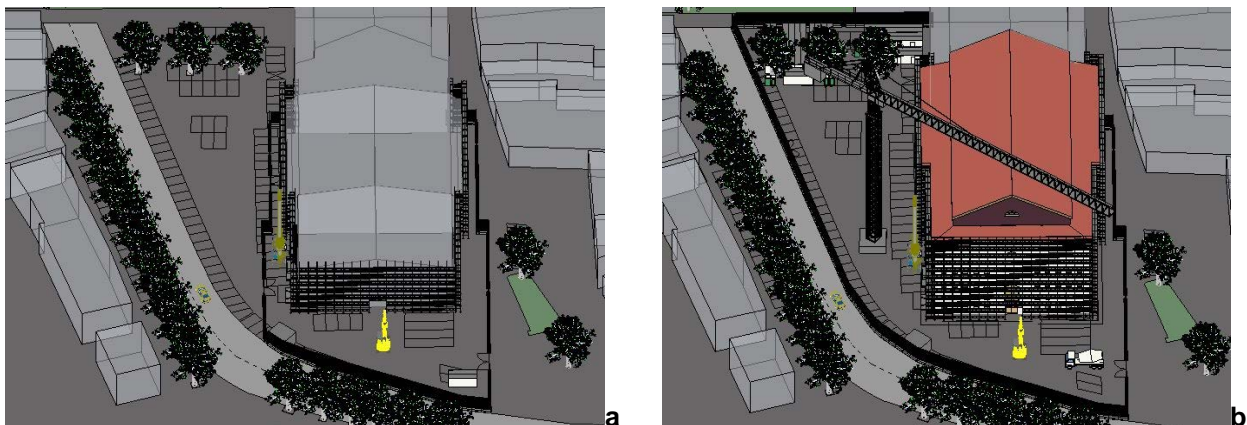

Figure 4.67. (a) Client's first phase of the site layout plan and (b) Client's second phase of the site layout plan.

Figure 4.68 and Figure 4.69 show a bidder's proposal for a different site layout plan divided in two phases (bidder A). In the first phase the fenced-in area is smaller as in the client's solution, but the pedestrian and vehicular access are different located as well as site offices. Moreover, in this case the crane is available from the beginning and the area is divided in two zones because one is dedicated only for loading and unloading of materials. In the second phase the site layout plan is bigger and it traces almost the same perimeter of the client's solution even if it is divided in two zones, because a smaller area is dedicated only for decoration works.

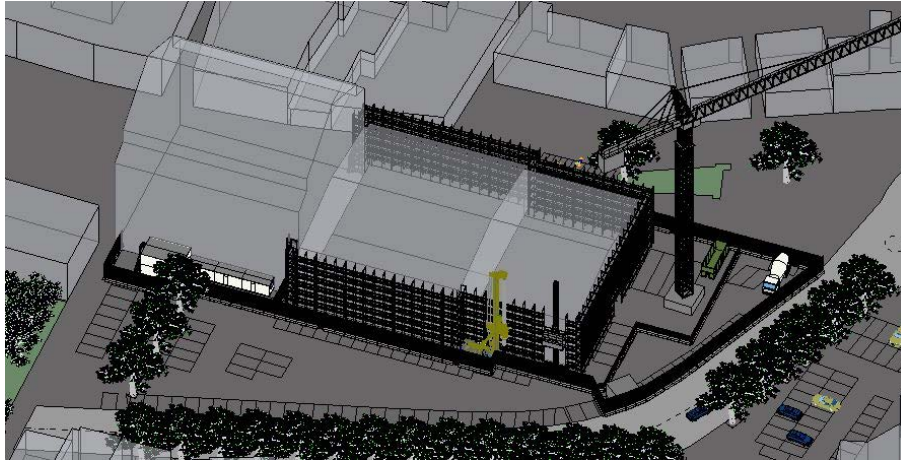

Figure 4.68. Bidder A's first phase of the site layout plan.

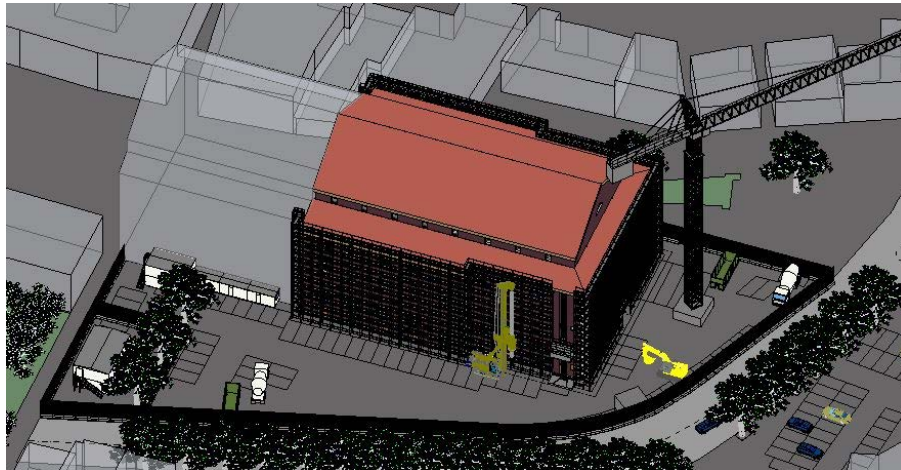

Figure 4.69. Bidder A's second phase of the site layout plan.

Figure 4.70, instead, shows a bidder's proposal for a different site layout plan in only one phase (bidder B). In this case the site layout plan traces almost the same perimeter of the client's and bidder A's solutions of their second phase. However, it is divided in two zones, where one is dedicated only to site offices and it has a private pedestrian entrance.

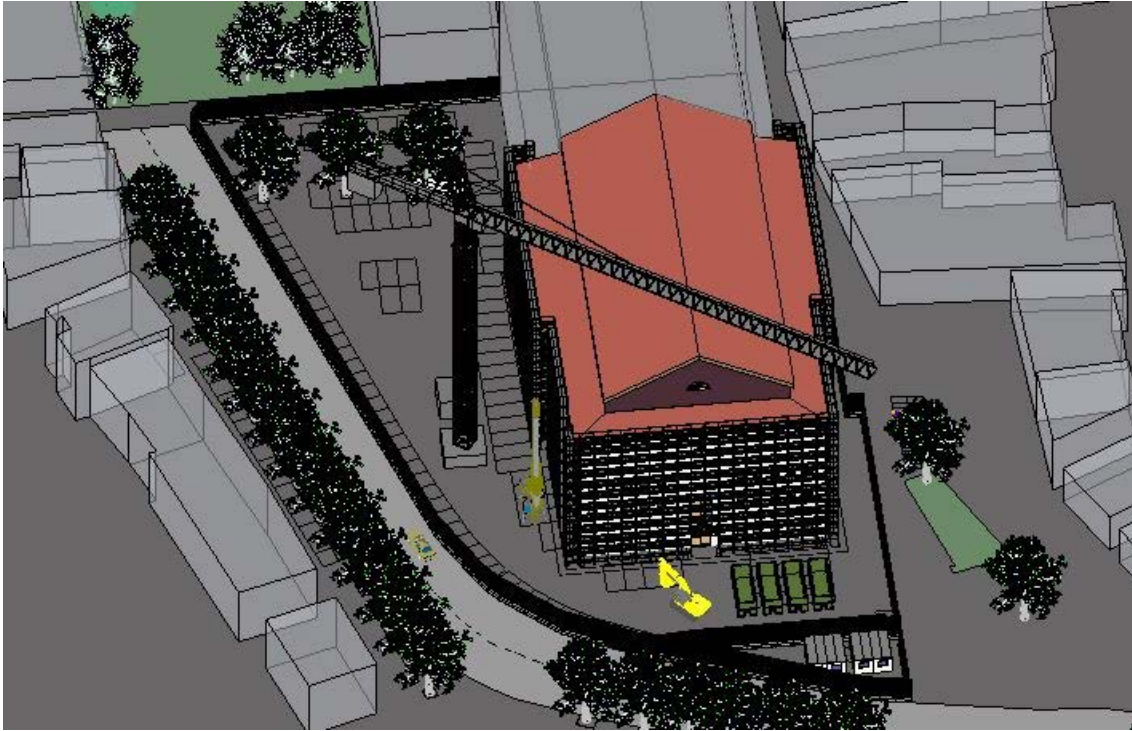

Figure 4.70. Bidder B's site layout plan.

Thanks to the software Solibri Model Checker (SMC) it is possible to control if bidders' proposals are in compliance with client's requirements. A set of rulesets was prepared in SMC, thanks to the Ruleset Manager tool, to control the presence of site equipment such as the crane, site offices, WC, garbage bins and the security office. Moreover, other rulesets were adopted to check the dimension of spaces and elements together with rules to control the distance between objects, the presence of elements in specific spaces and clearance in front of gates. The check of bidder A's proposal (Figure 4.71) shows that some components, such as the security office and the electrical cabinet, have not been modelled (Figure 4.72). Additionally, the area dedicated to the decoration works is too small (Figure 4.73) and it does not contain a WC. Some site offices are too far from gates (Figure 4.74a) and from WC (Figure 4.74b), and the height of the scaffoldings is not correct because it would have been 1.8 m or 2.1 m instead it is 2 m (Figure 4.75).

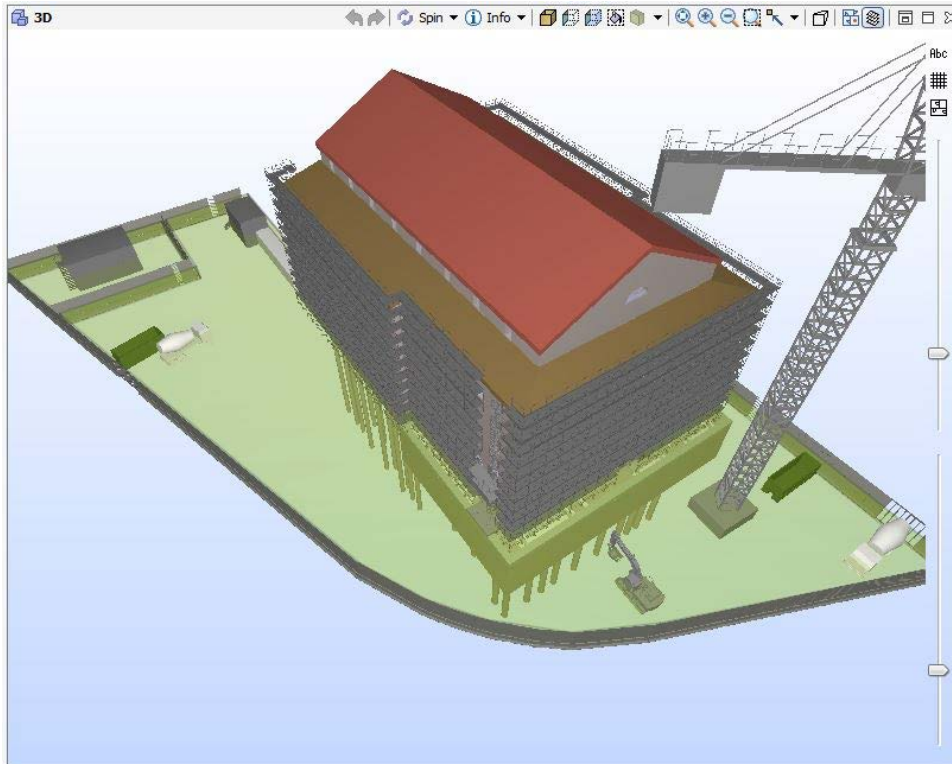

Figure 4.71. Bidder A's proposal imported in Solibri Model Checker v8.1.

Checking		Check	Report
Ruleset			
New Ruleset			
New Ruleset			
Site office Must Locate Near WC			⚠
Clearance in Front of gates			⚠ ⚠
Crane Must Be Defined			OK
Site office Must Be Defined			OK
Freight elevator Must Be Defined			OK
Fence Must Be Defined			OK
Scaffolding Must Be Defined			OK
Pedestrian and Vehicular Gates Must Be Defined			OK
WC Must Be Defined			OK
Security office Must Be Defined			⚠
Electric cabinet Must Be Defined			⚠
Site office Must Locate Near pedestrian gate			⚠
Fence Dimension Values			⚠
Scaffolding Dimension Values			⚠
Height Scaffolding			⚠
Space Area Check			⚠
Equipment in site space			⚠
Site office Must Locate Near gate			⚠

Figure 4.72. Checking results of bidder A's proposal in Solibri Model Checker v8.1.

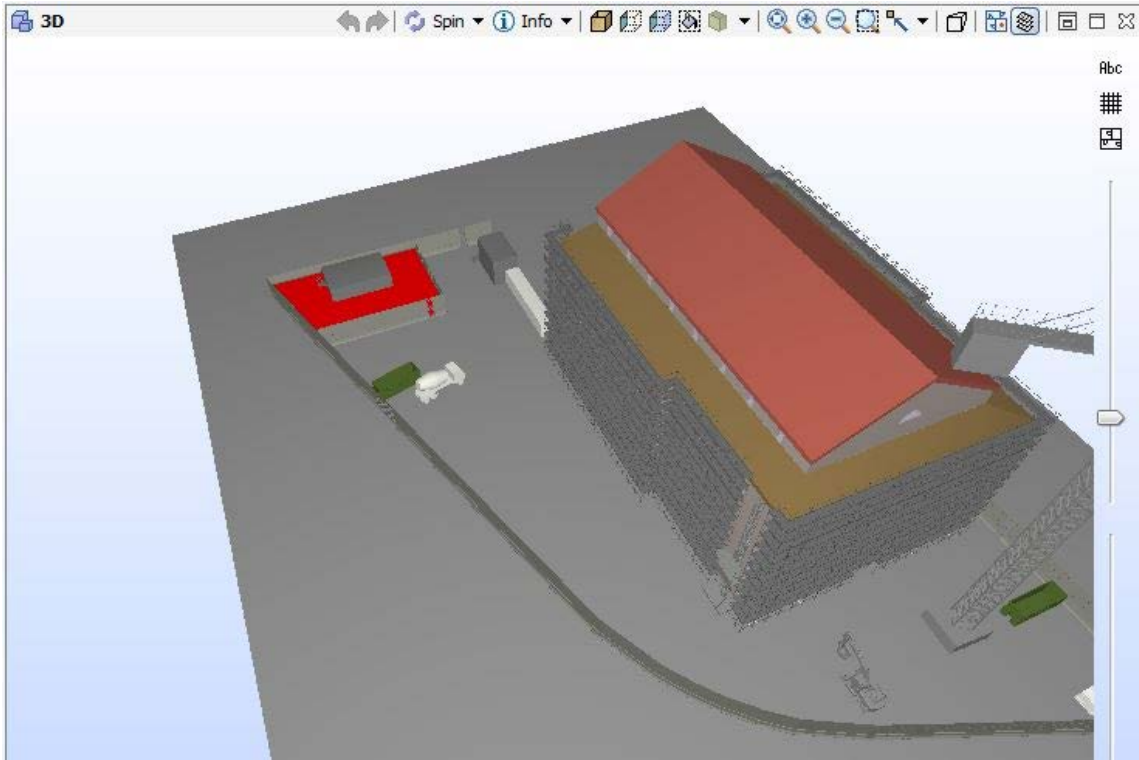

Figure 4.73. Ruleset in SMC v8.1 to check the dimension of spaces.

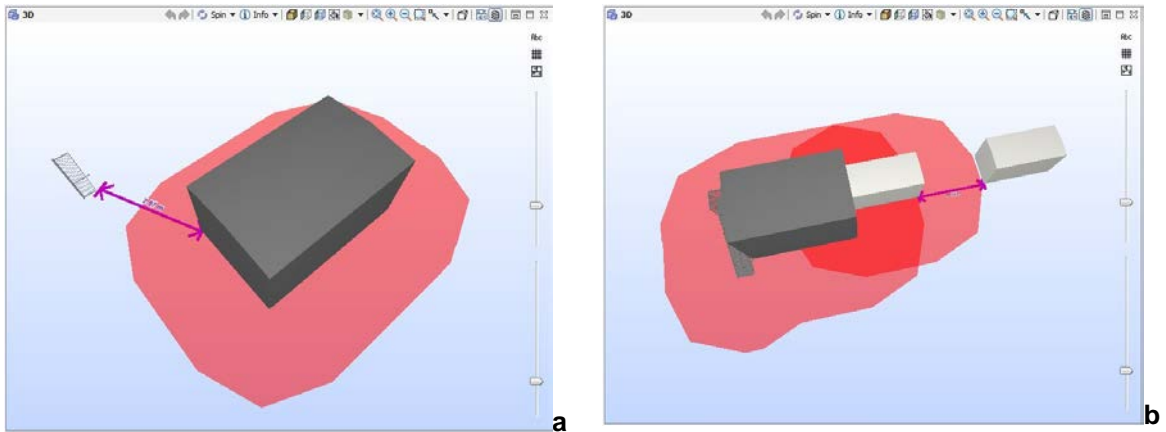

Figure 4.74. (a) Ruleset in SMC v8.1 to check distance from a site office to a pedestrian gate is not too long and (b) Ruleset in SMC v8.1 to check distance from a site office to a WC is not too long.

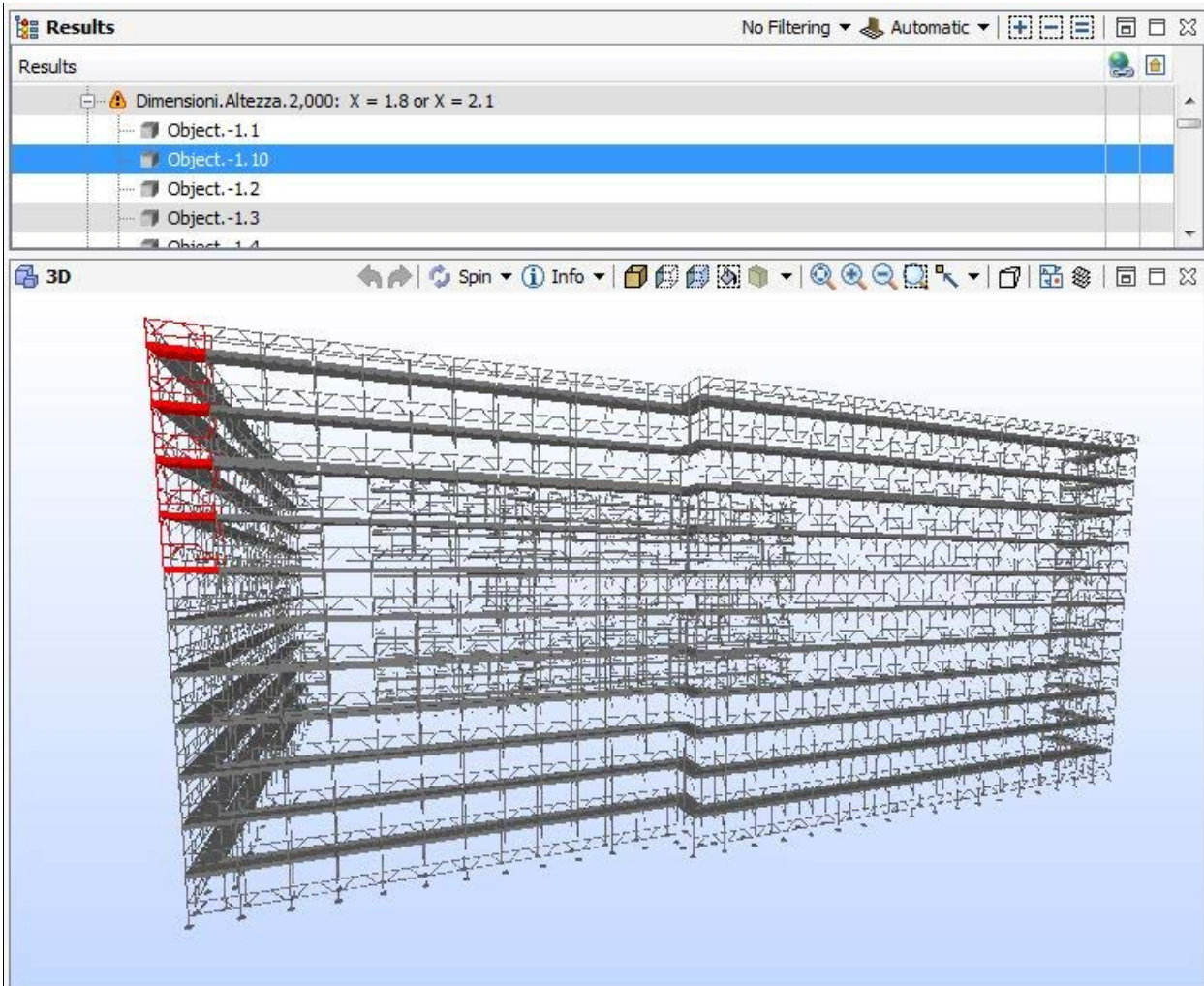

Figure 4.75. Ruleset in SMC v8.1 to check the dimension of scaffoldings.

SMC report's (Figure 4.76) indicates that some required components are not included in the bidder B's proposal (Figure 4.77), such as the security office and WC. Moreover, it shows that there is not enough space in front of some gates (Figure 4.78), that the pedestrian gate is too far from some site offices and that the height of the fences is not correct because the client has required 3 m height fences instead they are 4 m (Figure 4.79).



Figure 4.76. Bidder B's proposal imported in Solibri Model Checker v8.1.

Checking		Check	Report
Ruleset			
NEW RULESET			
New Ruleset			
§	Site office Must Locate Near WC		OK
§	Clearance in Front of gates	⚠	✖
§	Crane Must Be Defined		OK
§	Site office Must Be Defined		OK
§	Freight elevator Must Be Defined		OK
§	Fence Must Be Defined		OK
§	Scaffolding Must Be Defined		OK
§	Pedestrian and Vehicular Gates Must Be Defined		OK
§	WC Must Be Defined	⚠	
§	Security office Must Be Defined	⚠	
§	Electric cabinet Must Be Defined		OK
§	Site office Must Locate Near pedestrian gate	⚠	
§	Fence Dimension Values	⚠	
§	Scaffolding Dimension Values	⚠	
§	Height Scaffolding	⚠	

Figure 4.77. Checking results of bidder B's proposal in Solibri Model Checker v8.1.

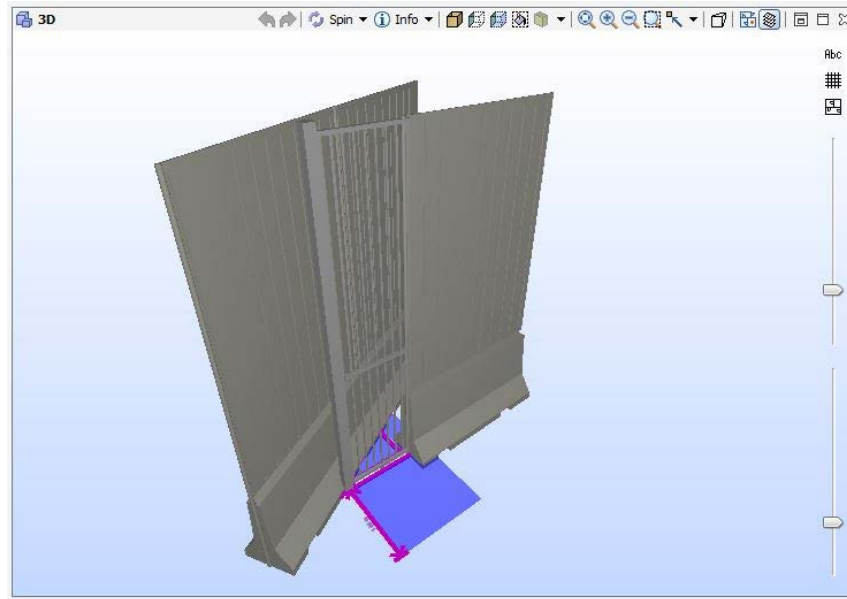

Figure 4.78. Ruleset in SMC v8.1 to check if there is enough clearance on both sides of a gate.

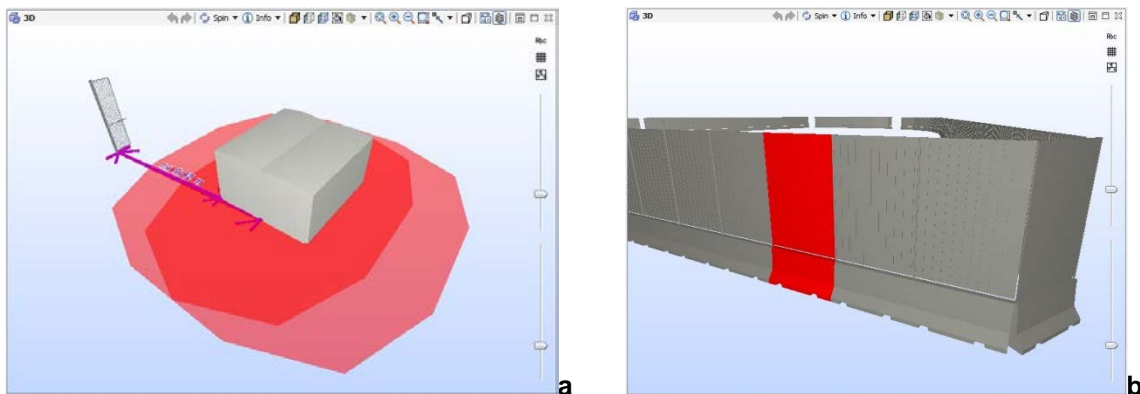

Figure 4.79. (a) Ruleset in SMC v8.1 to check distance from a site office to a pedestrian gate is not too long and (b) Ruleset in SMC v8.1 to check if the height of fences is correct.

Therefore, thanks to SMC, the client can quickly check possible omissions or errors in bidder's proposal and evaluate them. As already shown in paragraph 4.4.2, SMC generates reports of errors both in pdf and in excel formats. The jury could add a column in the excel file giving a different weight to different errors and calculate a final score. For example, an important requirement in the tender documentation was the presence of at least one security office, which instead is not present in both proposals. This fact could be relevant to exclude both bids.

Moreover, the bidders were allowed to present improvement proposals for systems. In this test a proposal concerns the moving of one air handling unit from the basement to an upper level and its splitting in two units was modelled. This solution reduces the number of canal systems and thanks to the separation of the canal systems of the or-

chestra, orchestra pit and stage, the energy consumption is reduced because it is possible to heat only one section and not the whole area. In the orchestra the bidder proposes the utilisation of the free volume under it to carry the air instead of adopting the plenum chambers and the canal systems. Therefore, this space is emptier to facilitate its maintenance (Figure 4.80).

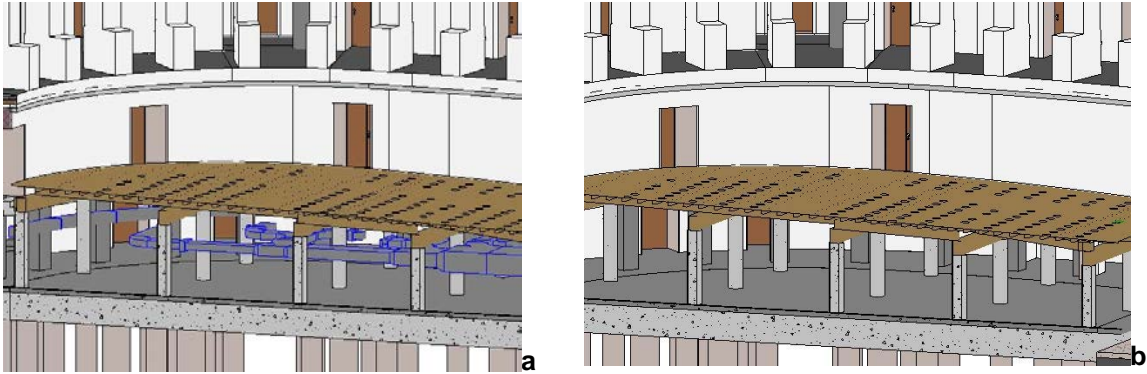

Figure 4.80. (a) Client's layout of duct systems under the stage and (b) Bidder's layout of ductsystems under the stage.

In this case study the jury compared very different systems solutions and a Model Checking software, such as SMC, would not have helped to compare different because is not simple to declare the most convenient option in general. Indeed, there is not a specific role to choose between e.g. a geotechnical and a heat pump system. The choice is very complex because several variables and parameters are involved. For example, the bidder's solution seems to be better than the client's one because there are less canals and so there will be savings for materials, the impact of the new layout is not onerous (Figure 4.81) and the maintenance will be easier. However, the position of the air handling units on an upper level probably will generate unpleasant noises, which are not welcome in a theatre. Thus, the location of these equipment in the basement remains the best solution for the lifecycle of the theatre.

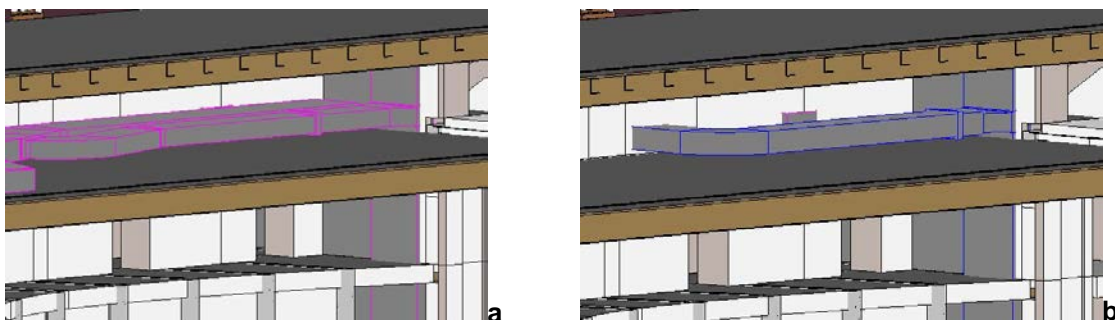

Figure 4.81. (a) Client's disposition of canal systems in an upper level and (b) Bidder's disposition of canal systems in an upper level.

Nevertheless, Model Checking software, can be utilised to check the integrity and the quality of a singular offer such as the dimension of canals, the distance between components, the presence of equipment and possible clashes. BIM remains a useful tool to

better understand the bidder's solutions thanks to the 3D visualisation (Figure 4.82 and Figure 4.83). Moreover, the client can easily comprehend the complexity of the proposals and find critical aspects due to the models integration of different disciplines.

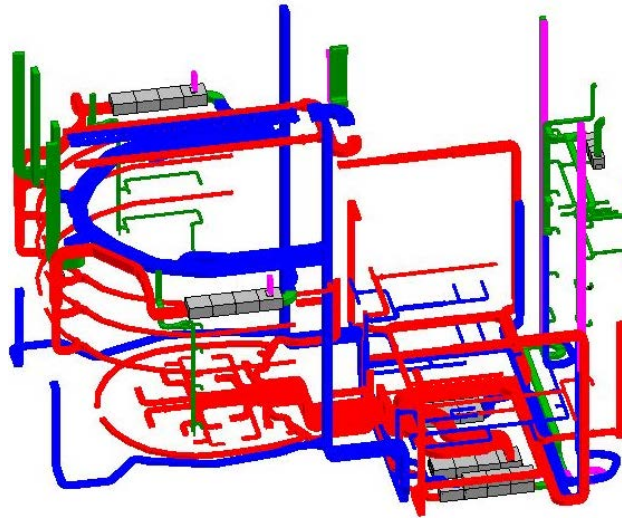

Figure 4.82. Client's layout of canal systems.

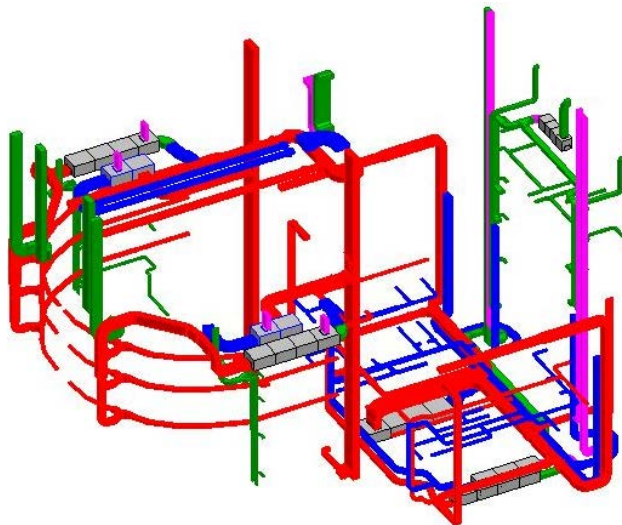

Figure 4.83. Bidder's layout of canal systems.

4.6.3 e-Procurement: i-Faber simulation

i-Faber was established in 2001 and according to Forrester Research international analysts, it is among the top global operators in the delivery of services and solutions for e-Procurement management. Indeed, i-Faber boasts operations in 20 European countries thanks to a platform and a support service available in 15 languages, along with well-established activities on over 500 purchase categories. It achieved a leading position in the field of procurement services for the Public Administration, serving 70 public administrations and companies (<http://www.i-faber.com>. Last visit 30 July 2013). Regarding only public administrations, on the other hand, i-Faber provides services that are not a customisa-

tion of a platform intended for private organisations, but rather the development of an ad-hoc service for the Italian Public Administration, in compliance with the Public Agencies Procurement regulations (D.Lgs, 12 April 2006, n. 163). i-Faber solution can manage, in a fully-secured manner, the whole purchase process, from the publication of the call for tender to the submission of supply orders for good and service contracts, to supplier qualification and pre-qualification. Up to date about 70 Agencies, including public companies, Regions, Municipalities, Provinces, Universities, Hospitals and other public entities, adopt i-Faber public administration solutions. Thanks to the Pleiade platform, i-Faber was the first in Italy to have managed a fully-online auction in the public administration (in March 2001, on behalf of Siena Municipality), a descending-price negotiation for the public administration (in March 2001, still on behalf of Siena Municipality), an online auction for public works (in 2003, on behalf of Livorno Municipality), the implementation of an e-Procurement solution on a territorial model (in 2002, on behalf of Mantua Municipality as a group of around 30 independent Entities). Moreover in 2008 Consip, joint-stock company of the Ministry of Economy and Finance, chose i-Faber platform as technological solution for its e-Procurement activity. Consip drew up and awarded for the first time in Italy a fully-online renegotiable Long Term Agreement, one of the innovative purchase tools provided for in the Public Contract Code which Consip itself signs with the economic operators in its capacity as National Procurement Agency. Moreover, also Region of Tuscany and Province of Bolzano adopt i-Faber platform and in the Province of Bolzano it is mandatory to use e-Procurement form 2009, instead in the city of Bolzano it is only recommended. In the Province of Bolzano the three years plan for the public expenditure is directly linked to the platform so it is easy to review how the public administration manage the public money since the data are available for everyone.

i-Faber platform for public administrations allows the management of tenders for goods, services and works, even if the last one is less popular due to the fragmentation and the greater complexity of the construction sector. A simulation of the Italian case has been carried out to investigate the benefits and the limits of the i-Faber platform. i-Faber supports the whole procurement from the published of the call for tender to the final test, even if not all the processes have been included and automated. For this reason some actions have to be done outside the platform and documents have to be attached (e.g. in .pdf format) because it is not possible to automatically generate them.

The public client/contracting authority must follow the login (guided) process for the first time, after which they can customise the platform and publish a call for tender. i-Faber platform is integrated to the Italian Vigilance Committee of Public Procurement (AVCP), to which the contracting authority has to send all the information related to the tender and from which they receive a tender identification code (CIG). If the contracting authority inserts the CIG in the i-Faber platform, all the information are automatically imported from the SIMOG system, a tool to monitor the public tender by AVCP (Figure 4.84).

Importa dati da SIMOG

 Se hai già acquisito il CIG di un lotto dall'Autorità di Vigilanza, puoi recuperare le informazioni in modo automatico per precompilare i campi principali del processo di creazione gara.
Se non disponi di CIG puoi proseguire nel processo ed eventualmente aggiungerlo successivamente.

Inserisci CIG

[Prosegui senza importare dati](#)

Figure 4.84. i-Faber platform: import of information from the SIMOG system.

Here we see how to import data from SIMOG ('Importa dati da SIMOG'). The information box explains that if the contracting authority already has the CIG, it is possible to automatically get the essential information to prepare a tender putting it in the box 'Inserisci CIG'. Otherwise, it is possible to continue the process and add the CIG at a later stage.

i-Faber platform helps the contracting authority to fill the form to prepare the call for tender step by step including all the needed information, such as the object, type of procurement, sector, type of procedure and amount of the tender (Figure 4.85 and Figure 4.86). Moreover, the contracting authority can specify the award criteria and ask to be informed in presence of irregular bids (Figure 4.87).

If the tender is over the EU threshold, the tender has to be published on the Official Journal of the European Union (OJEU). i-Faber platform automatically identifies the needed information and publishes the tender on the OJEU. If the publication on the OJEU is not required, instead, it is possible to fill the information adopting the platform or attaching the call for tender in a .pdf format, which has been previously generated outside the system by the contracting authority (the maximum size for each file is 10 MB) (Figure 4.88).

Usually all the additional documents related to the tender, such as terms of contract and technical specifications, are generated outside the platform and attached in a non-editable format because it is not possible to create them from i-Faber platform (Figure 4.89). The contracting authority can select a deadline for the download of the documentation (Figure 4.90) and at the end of the tender period is not possible to consult the tender materials anymore. If some information changes during the tender phase, the bidders are informed by email so they are always aware about the updated documentation.

Regarding the planning phase, which is carried out before the publication of the call for tender, i-Faber allows only to link the plans of the public expenditure to the object of the tender, but all the other documents must be generated outside the platform, and if needed attached in a non-editable format. The same procedure is conducted for the design phase and all the documentation can only be attached, as it happened in the Rimini case study, where all the 2D drawings and specifications were provided in a .pdf format. Moreover, the contracting authority (awarding organisation) can also create technical sheets in order to support the awarding phase, describing the object of the procurement and giving different weights to different parameters (Figure 4.91 and Figure 4.92). Example sheets are available to be customised by the contracting authority and an automatic classification is made at the end of the tender period to help the final award. This method is more suitable for the purchase of goods and service rather than for works because it is more difficult to describe the object of works with parameters due to its higher complexity. However, it would be developed to support also the procurement of work, e.g. creating a template for the curricula. In this way the evaluation of curricula can be more objective because different weights/points are given to different characteristics e.g. if one bidder has been working for a longer period in the same area of the current tender, they will receive an higher score, rather than another bidder with a longer experience in another sector.

If one contractor is included in the 'contractor list', when tenders are published, they will automatically receive the notice of tender dealing with their sector by email, if not they can find the call for tender checking the contracting authority's website page. Contractors must login themselves before being able to submit their proposal, this operation is needed only once, after that contractors can access the reserved area adopting a password. There are two ways to request information; the first allows everyone to ask questions whereas the second is only for registered users. Later the contracting authority can de-

side to publish an answer available for everyone or to send a private message to the sender. The bidders can submit their proposals and edit them by the deadline following a step by step procedure (Figure 4.93 and Figure 4.94). Before the final submission the bidder can control all the information and download a .pdf version of the offer, which they must sign and re-attach; after the final submission the bidders receive the code track of their bid. The electronic signature can be utilised by both the client and the bidders.

The contracting authority cannot see the offers until the end of the tender period, after that they must follow a specific order indicated by the Italian law to evaluate the bids: administrative, technical and economic offers. i-Faber does not support the evaluation process but only generates a classification of the economic bids. For this reason the awarding phase is carried out offline, even if i-Faber is developing an automatic system linked to AVCP to control the bidders' administrative requirements. The contracting authority can see the bids and evaluate if they are in compliance with the tender requirements and send them to the jury. If one bids does not respect the tender requirements, it is removed and the other parts of the bid are not available anymore e.g. if the administration documentation is not in compliance with the requirements, the contracting authority deletes the offer and they cannot evaluate the technical and economic bids. Each member of the jury can give a score to the bids for the technical offer and the platform automatically generates a classification at the end. If needed, the contracting authority can always revoke or delete the tender. At the end of this phase, the contracting authority can publish the classification and award the tender. The evaluation process can be carried out in a public session with the support of the platform. Once the contracting authority defines the winner, only they can access the platform even if the execution phase and the final tests are carried out offline and i-Faber only supports the contracting authority in order to provide some information required by AVCP.

i-Faber offers two business models. The first is based on an annual fee which the contracting authority must pay for the service. The second, on the other hand, is a sort of 'market payment', where the winner has to pay a specific percentage of the profit to i-Faber. The latter method is adopted by the Province of Bolzano, but it is not common because usually public payments take a lot of time and contractors have difficulty anticipating the money.

The integrity of data, their confidentiality, authenticity and availability, the security and reliability are guaranteed by the technological solutions of the platform. Moreover, i-Faber maintains the service in order to always assure the principles earlier illustrated.

Figure 4.85 shows essential information needed to prepare a tender, marked with the asterisk (*), and additional data. The main information is related to the object, description, type of procurement (work, services or goods), sector (ordinary or special), type of procedure (open, restricted or negotiated), operating method (tender with secret offers or not), execution method (telematic or traditional) and if the contracting authority is working for other public bodies or not. The additional information deals with the amount of the tender and the tender identification code. The information box explains that pushing the button 'Save and Next' ('Salva e Procedi') data are saved. However, it is possible to complete the process at a later stage selecting the button 'Making the tenders' ('Gare in composizione') if needed.

Figure 4.86 summarises the previous data which can be modified and it is possible to add new information such as type of execution (only works or also design planning) and if work are extremely urgent or not. Further data are related to associated categories, award criteria, lots, attached documentations and date of the tender. The information box explains that it is mandatory to fill all the required information.

4. Possible Implementation of BIM in Tendering

Modifica gara

Attenzione: Premendo 'Salva e Procedi', le informazioni inserite, se corrette, vengono immediatamente salvate. E' possibile completare il processo di pubblicazione della gara anche in un secondo momento, recuperando le informazioni salvate attraverso la funzione 'Gare in composizione' accessibile in spalla sinistra.

Oggetto (Italiano) *

Oggetto (Tedesco) *

Descrizione (Italiano) *

Descrizione (Tedesco) *

Tipo di appalto *

Settore *
 Ordinario Speciale

Modalità di realizzazione *

Settore *
 Ordinario Speciale

Modalità di realizzazione *

Contratto escluso *

Tipo di procedura *
 Aperta Ristretta Negoziata

Procedura di scelta del contraente *

Svolgimento *

Modalità di esecuzione *
 Telematica Tradizionale

L'amministrazione aggiudicatrice/ente aggiudicatore acquista per conto di altre amministrazioni aggiudicatrici/enti aggiudicatori? *
 Si No

Importo di gara (comprensivo di oneri di sicurezza)

Codice gara AVCP

[Torna al dettaglio gara](#)

I campi segnati con * sono obbligatori

Figure 4.85. i-Faber platform: initial tender information.

Dettaglio gara

 Per pubblicare la gara è necessario completare tutte le sezioni sottostanti. Per ciascuna sezione sono indicate le informazioni obbligatorie mancanti.

Comune di Barbiano

 **TEST LAVORI PUBBLICI** (In composizione)

Test lavori pubblici

Responsabile attuale: Rossetti Giancarlo (Comune di Barbiano), pab-sa-distribution@pleiade.it

Tipo di appalto: Lavori

Settore: Ordinario

Modalità di realizzazione: Contratto d'appalto

Tipo di procedura: Procedura aperta

Modalità di esecuzione: Telematica (online)

Svolgimento della gara: Gara in Busta Chiusa

Soglia di rilevanza comunitaria: Sopra soglia

Contratto escluso: No

Procedura di scelta del contraente: Procedura aperta

Importo di gara (comprensivo di oneri di sicurezza): € 19.770.000,00

[Modifica](#)

Informazioni aggiuntive

Tipo di prestazione: Sola esecuzione

Esecuzione di lavori di somma urgenza: No

[Modifica](#)

Categorie

Nessuna categoria associata.

Categorie

Nessuna categoria associata.

Associare almeno una categoria

[Aggiungi](#)

Criteri di partecipazione ed economici

Nessun criterio di partecipazione ed economico inserito

[Modifica](#)

Lotti

Nessun lotto inserito

Aggiungere almeno un lotto

Per aggiungere lotti impostare prima i criteri di partecipazione ed economici

Richieste d'invio documentazione

Nessuna richiesta inserita

[Aggiungi](#)

Documentazione allegata

Nessun documento inserito

[Aggiungi](#)

Date

Inserire le date di gara

[Aggiungi](#)

Attenzione! Selezionare un'opera nella sezione 'Informazioni aggiuntive'

[Elenco gare in composizione](#) Elimina

Figure 4.86. i-Faber platform: tender information.

4. Possible Implementation of BIM in Tendering

Criteri di partecipazione ed economici

i Selezionare il “Criterio di aggiudicazione” fra “Prezzo più basso” e “Offerta economicamente più vantaggiosa”.

In caso di “Offerta economicamente più vantaggiosa”, scegliere l’algoritmo utilizzato per la conversione dell’offerta economica in punteggio.

Indicare poi se si desidera accettare e/o aggiudicare offerte parziali (solo per alcuni lotti).

Indicare se richiedete la segnalazione delle offerte anomale.

Attenzione: Premendo 'Salva e Procedi', le informazioni inserite, se corrette, vengono immediatamente salvate. E' possibile completare il processo di pubblicazione della gara anche in un secondo momento, recuperando le informazioni salvate attraverso la funzione 'Gare in composizione' accessibile in spalla sinistra.

Dinamica *

Descrizione valuta *

Cifre decimali *

Presentazione delle offerte al netto di IVA * Sì No

Criterio di aggiudicazione * Prezzo più basso Offerta economicamente più vantaggiosa

Funzione di calcolo del punteggio

Obbligo a partecipare a tutti i lotti * Sì No

Segnalazione delle offerte anomale * Sì No

[Torna al dettaglio della gara](#)

Segnalazione delle offerte anomale * Sì No

[Torna al dettaglio della gara](#)

Figure 4.87. i-Faber platform: award criteria.

Here we see the set of award criteria. The information box explains that the contracting authority must select the award criteria between the lowest price or the most economically advantageous tender. In case of most economically advantageous tender, they have to define the algorithm to be used to transfer the economic offer in score. Additionally they must select if partial offers, related only to some lots, are accepted or not and if irregular tenders have to be pointed out. Also in this case, pushing the button ‘Save and Next’ (‘Salva e Procedi’), data are saved and it is possible to complete the process at a later stage selecting the button ‘Making the tenders’ (‘Gare in composizione’) if needed.

Documentazione allegata

Istruzioni

 **Negoziazione: Test lavori pubblici/Test lavori pubblici.**

Per allegare della nuova documentazione alla gara fate riferimento al riquadro "Inserimento nuovo documento"; è necessario specificare una descrizione e selezionare il documento da allegare cercandolo tramite il tasto "Sfoglia" sul proprio computer.

Sono ammessi più documenti e di formato differente (ad es. pdf, doc, rtf); la dimensione massima per ciascun documento è di **10MB**

Il file verrà rinominato per garantire la compatibilità in lettura fra i diversi sistemi operativi; il documento sarà comunque identificabile tramite la sua descrizione.



I documenti così allegati saranno visualizzati nel riquadro "Documenti allegati alla gara" e potranno essere eliminati tramite il tasto "Canc".

Il fornitore potrà accedere alla documentazione dalla pagina di dettaglio della gara stessa e scaricarla sul proprio disco fisso.

Figure 4.88. i-Faber platform: dimension of the attached documents.

Here we see the information box related to the attached data. It is possible to attach data pushing the button 'Add new document' ('Inserisci nuovo documento') and a description is needed. Several documents with different formats (such as pdf, doc or rtf) are accepted and the maximum dimension for each file is 10 MB. The file will be re-named to guarantee the compatibility between systems but it will be identified thanks to its description. The window 'Attached tender documents' ('Documenti allegati alla gara') shows the documents and the contractor authority can delete them pushing the button 'Delete' ('Canc'). Finally, the tenderer will be able to this window and download the documentation.

Documentazione allegata generica

#	Fase	Documento	Azioni
1	Generica	 Disciplinare (936.56KB)	<input type="button" value="Elimina"/>
2	Generica	 Bando di gara	<input type="button" value="Elimina"/>
3	Generica	 Auftragsbekanntmachung	<input type="button" value="Elimina"/>

[Aggiungi](#)

Figure 4.89. i-Faber platform: attached documentation.

Here we see the names of attached documents related to a generic phase such as the tender notice. Pushing the button on the right side 'Delete' ('Elimina'), it is possible to delete the file.

4. Possible Implementation of BIM in Tendering

Presentazione delle offerte

Data inizio:	Giorno inizio	24	Mese inizio	Maggio	Anno inizio	2013	Ora inizio	12	Minuto inizio	32
Data scadenza:	Giorno scadenza	24	Mese scadenza	Maggio	Anno scadenza	2013	Ora scadenza	13	Minuto scadenza	29

Documentazione disponibile fino a

24/05/2013 13:00

[Torna al dettaglio gara](#) [Salva e Procedi](#)

Figure 4.90. i-Faber platform: deadline of the tender period.

Here we see the time information related to the tender such as opening and close periods (day, month, year, hour and minute) and the deadline to consult the tender information.

Dettaglio questionario 24/05/2013 12:09:26

Computer

Stato: Bozza
 Descrizione per il fornitore: Computer
 Descrizione interna:
 Data creazione: 24/mag/2013 11.57.36
 Proprietario: Silvia Silvia

[Modifica](#)
[Configura documento \(Obbligatorio\)](#)

Elenco dei requisiti / gruppi

Tutti

N.	Ordine	Nome	Tipo	Descrizione interna	Data creazione	Azioni
1		Monitor	Gruppo		24/mag/2013 11.58.02	Modifica Elimina Anteprima
2		Desktop	Gruppo		24/mag/2013 11.58.27	Modifica Elimina Anteprima
3		Tastiera	Gruppo		24/mag/2013 11.58.41	Modifica Elimina Anteprima

[Aggiungi un nuovo requisito](#)
[Aggiungi un nuovo gruppo](#)
[Aggiungi un requisito dalla libreria](#)
[Aggiungi un gruppo dalla libreria](#)

[Torna alla gara](#) [Elimina](#) [Anteprima](#)

Figure 4.91. i-Faber platform: example of a technical sheet.

Here we see the technical sheet of a computer. There is a summary of the main information such as state of the process (draft or completed), description for the supplier, private description, date of creation and owner. The chart shows the components of the computer such as monitor, desktop and keyboard. It is possible to move the order of

the characteristics and modify, delete or see the preview. Moreover, the contracting authority can add a new requirement, group or select them from a library.

Modifica valutazione

24/05/2013 12:13:02

Computer

Nome	Tipo	Punteggio	Punteggio opzioni	Formula	Azioni
Diagonale	Opzioni (lista)	12,00	<ul style="list-style-type: none"> '13': 12 '15': 0 	Opzioni con singola scelta	Modifica  Test  Elimina
Colore	Opzioni (radio)	13,00	<ul style="list-style-type: none"> 'grigio': 13 'trasparente': 2 	Opzioni con singola scelta	Modifica  Test  Elimina
CPU	Testo	0,00			

Torna alla gara



Figure 4.92. i-Faber platform: example of a technical sheet with different weights for different parameters.

Here we see the two parameters of a computer: the dimension of the screen and the color. For each parameter it is possible to give a maximum score (12 for the dimension of the screen and 13 for the color) and give different weights (12 points for 13' or 0 for 15' and 13 points if the computer will be grey or 2 if transparent).

#	Passi della procedura	Stato	Documentazione richiesta
1	Forma di partecipazione / Dati identificativi	Da completare	
2	Documentazione amministrativa aggiuntiva	Non accessibile	
3	Modelli dinamici: inserimento dati	Non accessibile	
4	Documentazione amministrativa	Non accessibile	0 di 1
5.1	Offerta e documentazione per il lotto 1: Test lavori pubblici	Non accessibile	0 di 2
6	Conferma e invio	Non accessibile	

Figure 4.93. i-Faber platform: step by step procedure to submit a bid.

Here we see the condition ('Stato') of the procedure to submit a bid. There are consequential steps: 1) add the identification data; 2) further administration documentation; 3) dynamic models: add data; 4) administration documents; 5.1) Bid and documentation related to lot1; 6) Confirm and submit. The condition column shows if one step has been completed or not. The next column, instead, shows if documents are required ('Documentazione richiesta').

Invio documentazione.			
#	Descrizione	Modello	Valore / Documenti
1	Modalità assolvimento imposta di bollo:		Mediante marca da bollo <input type="button" value="Inserisci"/>
2	Pagamento mediante marca da bollo:		L'operatore economico dovrà stampare l'offerta economica e applicare una marca da bollo da 14,62 euro (una per ogni quattro facciate o cento righe) con annullo chiaro ed inequivocabile della stessa. L'operatore economico successivamente dovrà scansionare il documento così preparato, firmarlo digitalmente e ricaricarlo a sistema..
3	Offerta economica (E)		Ribasso percentuale: <input type="text" value="12"/> , <input type="text" value="00"/> <input type="button" value="Modifica"/> Valuta: €, 2 decimali Importo a base di gara: Euro 18.970.000,00 Oneri di sicurezza: Euro 800.000,00
2	Pagamento mediante marca da bollo:		annullo chiaro ed inequivocabile della stessa. L'operatore economico successivamente dovrà scansionare il documento così preparato, firmarlo digitalmente e ricaricarlo a sistema..
3	Offerta economica (E)		Ribasso percentuale: <input type="text" value="12"/> , <input type="text" value="00"/> <input type="button" value="Modifica"/> Valuta: €, 2 decimali Importo a base di gara: Euro 18.970.000,00 Oneri di sicurezza: Euro 800.000,00 L'offerta inserita si intende comprensiva del corrispettivo spettante al gestore del sistema in caso di aggiudicazione
4	Progetto operativo (T,2,6)	Modello	 t8776i469p4232l1f2nc21034ris11202.txt (198) <input type="button" value="Canc"/>
5	Offerta economica (E,3,6)	 Modello	 t8776i469p4232l1f2nc21038ris11201.txt (198) <input type="button" value="Canc"/>

(1) documento da inviare tradizionalmente,
 (2) documento da inviare telematicamente,
 (3) documento da inviare telematicamente e **Firmato Digitalmente**,
 (4) documento da inviare telematicamente o tradizionalmente a scelta dell'utente,
 (5) documento da inviare telematicamente **Firmato Digitalmente** o tradizionalmente (supporto cartaceo) a scelta dell'utente,
 (6) invio obbligatorio del documento,
 (7) invio obbligatorio: per la stessa richiesta sono ammessi uno o più documenti,
 (8) invio facoltativo del documento,
 (9) invio facoltativo: per la stessa richiesta sono ammessi nessuno, uno o più documenti,
 (A) richiesta Amministrativa,
 (T) richiesta Tecnica,
 (E) richiesta Economica.

Figure 4.94. i-Faber platform: set up of a bid.

Here we see the information related to the bid such as how to carry out the stamp duty, the percentage of decline (in this case 12,00%) and the attach documents of the construction project and of the economic offer. The footnotes indicate which information must be sent in a traditional way or electronically with a digital signature, which documents are mandatory or optional and if requirements deal with administration, technical or economic issues.

4.6.4 Discussion

First, tests that have been carried out on this case study show that BIM and Model Checking can be a useful tool to evaluate bidders' proposals. Indeed, they allow a better comprehension thanks to 3D visualisation and it is possible to quickly find omissions and errors adopting software such as SMC, which makes the comparison of proposals easier and more objective. However, these tools do not replace the experts' competence because the evaluation could be complex, such as the one related to the best system solution. Therefore, nowadays there are still some limitations to a fully automat-

ic tender evaluation process. The software should be developed to incorporate actions, which today are part of the human experience and best practice.

Secondly, there are several benefits related to the adoption of i-Faber platform. Indeed, the process is streamlined and it is possible to consult data whenever and wherever visiting the platform. Moreover, the integrity of the process is guaranteed, so all the information related to one project is archived in the same database and it is easier to check and manage the information. i-Faber offers a service in compliance with the normative framework. Some Italian Regions have decided to develop their own e-Procurement platform without adopting services available in the market. This choice, however, was not successful because updating and developing the service require a big effort and a complicated procedure.

Moreover, some bureaucratic obligations are automatically executed by i-Faber so the client does not need to worry about them. The process is more transparent and objective because the bidders have access to the same documents and the platform forces the contracting authority to follow specific steps included in the law.

However, there are still several challenges related to e-Procurement development, because the current procedure does not cover all the process and several phases have to be done offline outside the platform. For this reason much effort is required to integrate the process in order to generate and manage all the information within i-Faber platform.

Nowadays i-Faber does not implement BIM. i-Faber platform supports attached files of maximum 10 MB each, this dimension very often is not sufficient to load BIM files. For this reason i-Faber platform should develop a new technology to manage bigger files. Moreover, if BIM will be included in the platform, some changes will be required to take advantage of its potential. Indeed, BIM can be managed as an attached file, but it can also be adopted for several scopes, especially to support the evaluation phase. If i-Faber platform will be linked to Model Checking tools, such as Solibri Model Checker, the client will be able to better control the offers and declare the final winner. A report of errors or non-conformities should be automatically generated from the model checking software and sent to the jury to support decisions. Thanks to BIM, it would be useful to link all the information included in the tender phase to a database in order to utilise them during the following steps reducing time usually spent to re-insert these data. Therefore, BIM platforms, such as Aconex, 4Projects, Asite and Conject (more information is available at paragraph 3.5.4), should be incorporated to successfully manage not only large BIM files, but the whole BIM process in general.

However, the development of e-Procurement in Italy is still limited (around 8%) so the room of improvement is wide. There are barriers related to the availability of new technological systems but the biggest limitation is related to culture. For this reason a lot of effort is required to change the current approach and a Government's e-Procurement strategy is needed to speed up its widespread adoption.

5. Conclusions and Future Works

The aim of this thesis was to identify the main problems related to the bidding phase of different Public Procurement routes and to study how BIM could be utilised in Tendering to improve the current weak points, especially adopting Model Checking tools to select the best contractor.

This thesis showed that the BIM adoption for Tendering is still in its infancy and it is rarely utilised to evaluate bidder's proposals. Even if Model Checking tools are already available to help the jury, Public Clients seem to be not ready for a big change, both cultural and technological. Before requiring BIM in Tendering, the Client should have a clear idea of how to manage a BIM process together with its potential and bottlenecks. The Public Client's awareness is crucial in order to achieve a successful BIM-based tender. For this reason conferences and workshops should be held to disseminate the implementation of BIM. Moreover, national research projects should be financed to acquire a grounded knowledge. Only after these gradual steps, the Public Client can mandate BIM and include it as an official part of the procedure. In addition, BIM is a revolutionary process which demands novel technologies and changes in the way the procedures are conducted. Indeed, BIM can be implemented in different procedures, but it generates more advantages if there is a collaborative and integrated behaviour. New procurements methods, such as IPD, are emerging to support an innovative approach, based on sharing and communication since the earlier phases of the process. These methods are more suitable for BIM and they make the counterpart co-responsible, reducing claims. For this reason the Public Client should develop an integrated and collaborative behaviour together with new contracts and insurance forms, cutting down cultural and technical barriers. Moreover, the Public Client should utilise an appropriate Electronic Document Management Systems (EDMS) to exchange, track and store electronic documents.

One of the peculiarities of the Public Sector is the obligation to assure a transparent and neutral approach without favouring one part over another. For this reason Public Clients should encourage open standards, such as IFC, and Open BIM solutions in general.

The role of Public Bodies is crucial because Government as a client can be a driving force for improvements. The BIM development around the world is much differentiated. Its spread is advanced in the countries where the Government has adopted a BIM strategy, such as UK, or where Public Clients or construction authorities have required BIM such as in USA, Finland, Norway and Denmark.

For this reason Public Bodies should embrace BIM and start adopting it also during the Tendering. This thesis demonstrated that Model Checking technology is already available to support the Public Bodies' decision. Nowadays it does not replace the human's work and much effort is needed to develop this approach because it does not

cover all the aspects of the tendering. However, it can be a useful tool to evaluate the bidder's proposals and find possible contradictory information, omissions or errors, which usually generate delays, claims and increase costs. Thanks to Model Checking tools, the Public Client can easily set requirements and control if the bidders' proposals are in compliance with them. Rule-based software are powerful means because they enable the clients to customise rules and frequently they verify not only geometrical requirements but also conceptual ones. Thus, the Public Client can prepare a set of rulesets to be adopted in several tenders and modify them if necessary. At the same time, such approach would produce benefits also for the bidders, who would utilise these tools for self-assessment. In this way bidders cannot hope to bid low and make a profit later from weaknesses in tender information, but they can focus their efforts to produce more competitive bids.

Additionally, the Public Client's 'Knowledge Management' should be improved to avoid systematic errors and BIM can help to fulfil this goal because it can archive best practice solutions which can be adopted in several tenders.

Even if the Europe public authorities spend around 19% of GDP on works, goods and services, Public Procurement Directives cover only a small percentage of such expenditure. For this reason there is the need to find new solutions to create an effective internal market for EU Public Procurements and increase competitiveness. IT solutions, such as e-Procurement, seem to become strategic to better enforce non-discrimination and transparency principles to favour also cross border participation.

However, by now the development of e-Procurement in public works has been mostly related to goods and services and e-Auctions have been utilised. e-Procurement of works, instead, is still low implemented due to its greater complexity. Even though it is more difficult to be developed, it can offer a valuable support for Public Clients to manage and control the procedure. However, further researches should be done to investigate the degree of integration between Public Procurement works and e-Procurement platforms to better understand how to computerise the information during the process making it re-usable several times. Moreover, the integration between BIM and e-Procurement is still limited and further research is required also in this field in order to achieve optimal results.

All in all, there is room for improvement in the public construction tender phase. BIM has a huge potential in the construction industry to improve the overall process, especially the bidding one. Public Bodies just have to be more determined to explore all the advantages of this new approach and implement it as soon as possible to step into the future.

References

- ACA, 2008. Project Partnering Contract, PPC2000 (Amended 2008), Building Information Modelling (BIM) Supplement. Available at <<http://www.ppc2000.co.uk/documents/BIMsuppliment.pdf>> (last visit 22 April 2013).
- AIA, 2007a. Integrated Project Delivery. A Working Definition, Version 2 Updated 06.13.2007. Available at <<http://aiacc.org/wp-content/uploads/2010/07/A-Working-Definition-V2-final.pdf>> (last visit 26 October 2012).
- AIA, 2007b. Integrated project delivery: a Guide, Version 1. Available at <<http://www.aia.org/groups/aia/documents/pdf/aiab083423.pdf>> (last visit 25 January 2013).
- AIA, 2008. AIA Document E202 – 2008. Building Information Modeling Protocol Exhibit. Available at <<http://www.fm.virginia.edu/fpc/ContractAdmin/ProfSvcs/BIMAIASample.pdf>> (last visit 22 February 2013).
- AIA, 2013. AIA Document E203 – 2013. Building Information Modeling and Digital Data Exhibit. Available at <http://www.aia.org/aiacmp/groups/aia/documents/pdf/aia_b099084.pdf> (last visit 24 August 2013).
- Alt, A. 2011. The Current situation with BIM in Estonia and plans for future. Available at <http://www.skaitmeninestatyba.lt/files/Konferencija/Prezentacijos/6_Aivars%20Alt_The%20Current%20situation%20with%20BIM%20in%20Estonia.pdf> (last visit 18 June 2013).
- Apila, 2010. Apila design summary & technical data. Viikki Synergy Building, Finnish Environment Institute's Eco-Efficient Office Building. Available at <http://www.senaatti.com/tiedostot/Apila_design_summary-technical_data_web.pdf> (last visit 15 March 2013).
- Associated General Contractors of America, 2009. Contractor's Guide to BIM. Version 2.
- Azhar, S., Hein, M. and Sketo, B., 2008. Building Information Modeling (BIM): Benefits, Risks and Challenges. Proceedings of the 44th ASC National Conference, Auburn, Alabama, USA. Available at <<http://ascpro.ascweb.org/chair/paper/CPGT182002008.pdf>> (last visit 17 May 2013).
- Azzone, G., Buzzetti, P., Squinzi, G. and Torretta, P., 2012. Edilizia smart, il Governo agisca. Il Sole 24 Ore, 6 October. Available at <<http://www.ilsole24ore.com/art/commenti-e-idee/2012-10-06/edilizia-smart-governo-agisca-081455.shtml?uid=Ab967HpG&fromSearch>> (last visit 14 October 2012). In Italian.
- Barker, P., 2011. Ryder Architecture and BIM, [online] August 2011. NBS. Available at <<http://www.thenbs.com/topics/bim/articles/RyderArchitectureAndBIM.asp>> (last visit 17 January 2013).
- BCA, 2012. Singapore BIM Guide Version 1.0. Available at <http://www.corenet.gov.sg/integrated_submission/bim/BIM/Singapore_BIM_Guide_Version_1.pdf> (last visit 17 January 2013).

- BCA, 2013. Singapore BIM Guide Version 2.0. Available at <http://www.corenet.gov.sg/integrated_submission/bim/BIM/Singapore%20BIM%20Guide_V2.pdf> (last visit 23 August 2013).
- Bedrick, J., 2013a. A Level of Development Specification for BIM Processes. AEC-bytes. Available at <http://www.aecbytes.com/viewpoint/2013/issue_68.html> (last visit 24 June 2013).
- Bedrick, J., 2013b. The Model Development Specification (MDS). AEC Process Engineering. Available at <<http://aecpe.com/Model%20Development%20Specification.pdf>> (last visit 11 July 2013).
- Bell, H., Bjørkhaug, L. and Hjelseth, E., 2009. Standardized Computable Rules. Standards Norway. December 2009. Available at <http://www.standard.no/Global/PDF/Bygg,%20anlegg%20og%20eiendom/Rule_Checking_Report%20web%20stor%20fil.pdf> (last visit 23 April 2013).
- Bellomo, G., 2012. BIM and Model Checking Serving People with Disabilities. In: Solibri Magazine 1/2012. Available at <<http://www.solibri.com/magazine/solibri-magazine-1-2012-published.html>> (last visit 25 April 2013).
- BIMForum, 2013. Level of Development Specification. Draft 1 April 19 2013. Available at <<http://bimforum.org/wp-content/uploads/2013/05/DRAFT-LOD-Spec-2.pdf>> (last visit 14 July 2013).
- BIM Task Group, 2013a. HMYOI Cookham Wood. Houseblock and Education Building. [online] Available at <<http://www.bimtaskgroup.org/wp-content/uploads/2013/07/HMYOI-Cookham-Wood.pdf>> (last visit 19 July 2013).
- BIM Task Group, 2013b. Early Adopter Project – Ministry of Justice – HMYOI Cookham Woo. New House Block and Education Building. BIM Lessons Learnt. Report Version 3 – February 2013. [online] Available at <<http://www.bimtaskgroup.org/wp-content/uploads/2012/03/Cookham-Wood-Consolidated-Lessons-Learned-version3-with-intro.pdf>> (last visit 19 July 2013).
- BIM Task Group, 2013c. Client Guide to 3D Scanning and Data Capture. [online] Available at <<http://www.bimtaskgroup.org/wp-content/uploads/2013/07/Client-Guide-to-3D-Scanning-and-Data-Capture.pdf>> (last visit 30 July 2013).
- BIPS, 2007. 3D Working Method 2006. Digital Construction. Available at <http://changeagents.blogs.com/Linked_Documents/BIPS%203D%20Working%20Method.pdf> (last visit 6 June 2013).
- Bloor, M. and Owen, J. 1995. Product data exchange. UCL Press, London.
- Board of Regents University System of Georgia, 2013. Architecture and Engineering Design Standards For Building Technology (GT-Yellow Book). Georgia Tech. Design & Construction. Facilities Management Available at <<http://www.facilities.gatech.edu/dc/standards/GTSpec.pdf>> (last visit 20 July 2013).

- Bof, F. and Previtali, P., 2011. National models of public (e)-procurement in Europe. *Journal of e-Government Studies and Best Practices*. Vol. 2010 (2010). IBIMA Publishing. Available at <<http://www.ibimapublishing.com/journals/JEGSBP/2010/315295/315295.pdf>> (last visit 3 December 2012).
- Both, P. v., 2012. Potentials and Barriers for Implementing BIM in the German AEC Market: Results of a Current Market Analysis. In: *Proceedings of the 30th eCAADe Conference, Prague, Czech Republic, 12-14 September 2012*. Available at <http://www.irbnet.de/daten/kbf/kbf_e_F_2844.pdf> (last visit 27 July 2013).
- Build Smart, 2011. Public Sector leads the way in BIM. Issue 09. December 2011. [online] Available at <http://www.bca.gov.sg/publications/BuildSmart/others/buildsmart_11issue9.pdf> (last visit 22 June 2013).
- BuildingSMART, 2011a. A National Strategy for the Adoption & Implementation of BIM. In: *MESH Conference Series 2011*. [online] Available at <<http://buildingsmart.org.au/MESH%20Conference%20Manifesto-Final.pdf>> (last visit 12 November 2012).
- BuildingSMART, 2011b. Public Sector demand for BIM. In: *Newsletter No 6 November 2011*. [online] Available at <<http://www.buildingsmart.org/resources/publications/newsletters-magazines/No%206%20SI%20newsletter.pdf>> (last visit 17 March 2013).
- BuildingSMART, 2013a. IFC4-the new buildingSMART Standard. [online] Available at <http://www.buildingsmart-tech.org/specifications/ifc-releases/ifc4-release/buildingSMART_IFC4_WhatisNew.pdf> (last visit 3 June 2013).
- BuildingSMART, 2013b. Annual Report 2012. [online] Available at <<http://www.buildingsmart.org/resources/publications/buildingsmart-international-annual-reports/annual-report-2012>> (last visit 3 June 2013).
- BuildingSMART Australasia, 2012. National Building Information Modelling Initiative. Volume 1: Strategy. Available at <http://buildingsmart.org.au/nbi-folder/NationalIBIMInitiativeReport_6June2012.pdf> (last visit 25 June 2013).
- Building Information Modelling (BIM) Task Group, 2013. Employer's Information Requirements, Version 07: 28.02.13, Core Content and Guidance Notes. Available at <<http://www.bimtaskgroup.org/bim-eir-faqs/>> (last visit 23 April 2013).
- British Standards Institution, 2013a. PAS 91:2003. Construction prequalification questionnaires. Available at <<http://shop.bsigroup.com/en/forms/PASs/PAS-91-2013/>> (last visit 25 May 2013).
- British Standards Institution, 2013b. PAS 1192-2:2003. Specification for information management for the capital/delivery phase of construction projects using building information modelling. Available at <<http://shop.bsigroup.com/en/forms/PASs/PAS-1192-2/>> (last visit 25 May 2013).
- Cabinet Office, 2011. Government Construction Strategy. Available at <http://www.cabinetoffice.gov.uk/sites/default/files/resources/Government-Construction-Strategy_0.pdf> (last visit 12 October 2012).

- Cabinet Office, 2012. Government Construction, Construction Trial projects. Available at <<http://www.cabinetoffice.gov.uk/sites/default/files/resources/Trial-Projects-July-2012.pdf>> (last visit 12 October 2012).
- Cabinet Office, 2012c. Government Construction, Project Bank Accounts – Briefing document. 10th February 2012 Available at <https://www.gov.uk/government/uploads/system/uploads/attachment_data/file/62117/Project-Bank-Accounts-briefing.pdf> (last visit 17 May 2013).
- Chawla, R., 2012. BIM legal issues from a practical perspective, [online] November 2012. NBS. Available at <<http://www.thenbs.com/topics/BIM/articles/bimLegalIssuesFromPracticalPerspective.asp>> (last visit 7 January 2013).
- Ciribini, A., 2011a. L'Infrastruttura e il Building Information Modelling nell'ottica dell'e-Government per la gestione dei Processi Autorizzativi e degli Appalti Pubblici. Brescia: DICATAM, Università degli Studi di Brescia. In Italian.
- COBIM, 2012. Finnish Common BIM Requirements v 1.0. Series 1: General part, Series 2: Modeling of the Starting Situation, Series 3: Architectural Design, Series 4: MEP Design, Series 5: Structural Design, Series 6: Quality Assurance, Series 7: Quantity Take-off, Series 8: Use of Models for Visualization, Series 9: Use of Models in MED Analyses, Series 10: Energy Analysis, Series 11: Management of a BIM Project, Series 12: Use of Models in Facility Management, Series 13: Use of Models in Construction. Available at <<http://www.en.buildingsmart.kotisivukone.com/3>> (last visit 28 June 2012).
- Construction Manager, 2012a. We need to talk about BIM. April 2012, pp. 16–21. Available at <<http://headley.co.uk/headturner/CM0412>> (last visit 19 June 2013).
- Construction Manager, 2012b. Taking an integrated approach to insurance. May 2012, pp. 24–25. Available at <<http://headley.co.uk/headturner/CM0512>> (last visit 15 March 2013).
- Construction Manager, 2013. Brussels set to enshrine BIM in EU-wide Procurement directive. 24 July 2013. Available at <http://www.construction-manager.co.uk/news/brussels-set-enshrine-bim-eu-wide-procurement-dire/?utm_campaign=19+July+CM+WEEKLY+ROUNDUP&utm_source=emailCampaign&utm_medium=email&utm_content> (last visit 27 July 2013).
- Costa, A. A., Arantes, A. and Valadares Tavares, L., 2013. Evidence of the impacts of public e-procurement: The Portuguese experience. *Journal of Purchasing & Supply Management*, 19(4), pp. 238–246. Available at <<http://www.sciencedirect.com/science/article/pii/S1478409213000757>> (last visit 22 August 2013).
- Daniotti, B., Re Cecconi, F. and Pavan, A., 2012. INNOVANCE: The Italian performance based construction database. In: G. Alaimo, A. Carbonari, A. Ciribini, B. Daniotti, G. Dell'Osso and M. A. Esposito, 2012. *The Missing Brick: Towards a 21st-century Built Environment Industry*. Maggioli Editore, pp. 275–293.

- D.Lgs, 12 April 2006, n. 163, Codice dei contratti pubblici relative a lavori, servizi e forniture in attuazione delle direttive 2004/17/CE e 2004/18/CE. Available at <<http://www.camera.it/parlam/leggi/deleghe/06163dl.htm>> (last visit 3 March 2013). In Italian.
- Department of Business, Innovations and Skills, 2011. A report for the Government Construction Client Group. Building Information Modelling (BIM) Working Party. Strategy Paper. UK: Department of Business, Innovations and Skills. Available at <<http://www.bimtaskgroup.org/wp-content/uploads/2012/03/BIS-BIM-strategy-Report.pdf>> (last visit 22 February 2013).
- Dimyadi, J. and Amor, R., 2013. Automated Building Code Compliance Checking – Where is it at? In Proceeding of 19th International CIB World Building Congress, Brisbane, Australia, 6–9 May 2013. Available at <http://www.researchgate.net/publication/236681238_Automated_Building_Code_Compliance_Checking_-_Where_is_it_at?ev=prf_pub> (last visit 20 July 2013).
- Ding, L., Drogemuller, R., Jupp, J., Rosenman, M. A. and Gero, J. S., 2004. Automated code checking. In: CRC for Construction Innovation, Clients Driving Innovation International Conference. Surfers Paradise, Qld, 25-27 October 2004. Available at <<http://cs.gmu.edu/~jgero/publications/2004/04DingetalCRCCode.pdf>> (last visit 1 November 2012).
- Dorsey, R. W., 1997. Project delivery systems for building construction. Washington: Associated general contractors of America.
- D.P.C.M., 1997. Determinazione dei requisiti acustici passivi degli edifici. 5/12/97. In Italian.
- Eadie, R., Perera, S., Heaney, G. and Carlisle, J., 2007. Drivers and Barriers to Public Sector e-procurement within Northern Ireland's Construction Industry. In: ITcon Journal, Vol. 12, pp. 103–120. Available at <<http://www.itcon.org/2007/6>> (last visit 15 November 2012).
- Eadie, R., Perera, S. and Heaney, G., 2010a. Identification of E-Procurement Drivers and Barriers for UK Construction Organisations and Ranking of these from the Perspective of Quantity Surveyors. In: ITcon, Vol. 15, pp. 23–43. Available at <<http://www.itcon.org/2010/2>> (last visit 15 November 2012).
- Eadie, R., Perera, S. and Heaney, G., 2010b. A Cross Discipline Comparison of Rankings of E-Procurement Drivers and Barriers for UK Construction Organisations. In: ITcon, Vol. 15, pp. 217–233. Available at <<http://www.itcon.org/2010/17>> (last visit 15 November 2012).
- Eadie, R., Perera, S. and Heaney, G., 2011. Analysis of the Use of e-procurement in the Public and Private Sectors of the UK Construction Industry. In: ITcon, Vol. 16, Special Issue Innovation in Construction e-Business, pp. 668–686. Available at <<http://www.itcon.org/2011/39>> (last visit 15 November 2012).
- Eadie, R., Perera, S., Millar, P., Perera, S., Heaney, G. and Barton, G., 2012. E-readiness of construction contract forms and e-tendering software. In: International

- Journal of Procurement Management, Volume 5, Number 1/2012, pp. 1–26. Available at <<http://www.inderscience.com/storage/f108125429161137.pdf>> (last visit 15 November 2012).
- East, E. W., 2013. Construction Operations Building Information Exchange (COBie). [online] Whole Building Design Guide (WBDG). Last updated 04-22-2013. Available at <<http://www.wbdg.org/resources/cobie.php>> (last visit 4 June 2013).
- Eastman, C., Lee, J., Jeong, Y. and Lee, J., 2009. Automatic rule-based checking of building designs. *Automation in Construction*, 18(8), pp. 1011–1033. Available at <<http://www.sciencedirect.com/science/article/pii/S0926580509001198>> (last visit 3 December 2012).
- Eastman, C., Teicholz, P., Sacks, R., and Liston K., 2011. *BIM Handbook: A guide to Building Information Modeling for Owners, Managers, Designers, Engineers and Contractors*. 2nd ed. USA: John Wiley & Sons, Inc.
- European Commission, 2012. Communication from the Commission to the European Parliament, the Council, the European Economic and Social Committee and the Committee of the Regions COM (2012) 179 final of 20 April 2012, A strategy for e-procurement. Available at <http://ec.europa.eu/internal_market/publicprocurement/docs/eprocurement/strategy/COM_2012_en.pdf> (last visit 30 May 2012).
- European Commission, 2011. Evaluation Report Impact and Effectiveness of EU Public Procurement Legislation. Part 1. SEC (2011) 853 final, Brussels, 27 June 2011, A strategy for e-procurement. Available at <http://ec.europa.eu/internal_market/publicprocurement/docs/modernising_rules/er853_1_en.pdf> (last visit 30 May 2012).
- European Parliament, 2013. Report on the on the proposal for a directive of the European Parliament and of the Council on public procurement. Proposal for a directive (COM (2011) 0896 – C7-0006/2012 – 2011/0438 (COD)). Draft report by Marc Tarabella (PE483.468v02-00). 9.1.2013. Available at <<http://www.europarl.europa.eu/document/activities/cont/201301/20130110ATT58822/20130110ATT58822EN.pdf>> (last visit 21 April 2013).
- European Parliament, 2004. Directive 2004/18/EC of the European Parliament and of the Council of 31 March 2004 on the coordination of procedures for the award of public works contracts, public supply contracts and public service contracts. Available at <<http://eur-lex.europa.eu/LexUriServ/LexUriServ.do?uri=OJ:L:2004:134:0114:0240:EN:PDF>> (last visit 13 December 2013).
- Foulkes, J., 2012. Design and Build Procurement in the context of BIM and the Government Construction Strategy. [online] Available at <<http://www.fgould.com/uk/articles/design-and-build-procurement-context-bim-and-gover/>> (last visit 17 January 2013).
- Furneaux, C. and Kivvits, R., 2008. *BIM – Implications for Government*. CRC for Construction Innovation, Brisbane. Available at <<http://eprints.qut.edu.au/26997/1/26997.pdf>> (last visit 12 June 2013).

- Gibbs, D. J., Emmitt, S., Ruikar, K. and Lord, W., 2012. An investigation into whether Building Information Modelling (BIM) can assist with construction delay claims. In: Conference Proceedings. First UK Academic Conference on BIM. Newcastle Business School & School of Law Building, City Campus East, Northumbria University, 5–9 September 2012, pp. 36–44. Available at <<http://collab.northumbria.ac.uk/bim2/wp-content/uploads/2012/09/Proceedings-for-the-First-UK-Academic-Conference-on-BIM.pdf>> (last visit 26 August 2013).
- Greenwood, D., Lockley, S., Malsane, S. and Matthews, J., 2010. Automated compliance checking using building information models. In: The Construction, Building and Real Estate Research Conference of the Royal Institution of Chartered Surveyors. Dauphine Université, Paris, 2–3 September 2010. London: RICS. Available at <http://nrl.northumbria.ac.uk/6955/1/Automated_compliance_checking_using_building_information.pdf> (last visit 1 November 2012).
- Grilo, A. and Jardim-Goncalves, R., 2011. Challenging electronic procurement in AEC sector: A BIM-based integrated perspective. *Automation in Construction*, 20(2), pp. 107–114. Available at <<http://www.sciencedirect.com/science/article/pii/S0926580510001378>> (last visit 28 December 2012).
- Grilo, A. and Jardim-Goncalves, R., 2013. Cloud-Marketplaces: Distributed e-procurement for the AEC sector. *Advanced Engineering Informatics*, 27(2), pp. 160–172. Available at <<http://www.sciencedirect.com/science/article/pii/S1474034612000973#>> (last visit 20 December 2012).
- Grilo, A. and Jardim-Goncalves, R., 2010. Electronic Public Procurement of Construction and Public Works: towards a new reality. In: 4th International Public Procurement Conference, Part 5(2). Available at <<http://www.ippa.org/IPPC4/Proceedings/05e-Procurement/Paper5-2.pdf>> (last visit 7 January 2013).
- Guttormsson, S., 2011. Implementation of BIM in Iceland. 7th semester dissertation. Bachelor of Architectural Technology and Construction Management. VIA University College. Available at <<http://revit.is/wp-content/uploads/2012/08/Implementation-of-BIM-in-Iceland-.pdf>> (last visit 9 June 2013).
- Hamil, S., 2013. BIM and Automation. [online] Available at <<http://bimcrunch.com/component/k2/item/598-bim-and-automation>> (last visit 30 July 2013).
- Hampson, K. and Kraatz, J., 2013. Modelling, Collaboration and Integration: A Case Study for the Delivery of Public Buildings. In: Proceedings of the 19th CIB World Building Congress, Brisbane, Australia, 6–9 May 2013. Available at <<http://eprints.qut.edu.au/59659/>> (last visit 24 July 2013).
- Harty, J. and Laing, R., 2009. Drivers for Change in Construction Procurement and its Impact on Management. In: 2009 Second International Conference in Visualisation. Barcelona, Spain, 15–17 July 2009. Los Alamitos: IEEE Computer Society. Pp. 138–143. Available at <<http://ieeexplore.ieee.org/stamp/stamp.jsp?tp=&arnumber=5230730>> (last visit 5 November 2012).

- Hjelseth, E. and Nisbet, N., 2010. Overview of concepts for model checking, In: CIB W78 2010, 27th International Conference – Applications of IT in the AEC Industry. Cairo, 16–18 November 2010. Available at <http://www.academia.edu/873824/Overview_of_concepts_for_model_checking> (last visit 18 April 2012).
- Hjelseth, E., 2012. Converting performance based regulations into computable rules in BIM based model checking software. In: G. Gudnason and R. Scherer eds. 2012. eWork and eBusiness in Architecture, Engineering and Construction. London: Taylor & Francis Group. Ch.60, pp. 461–469. Available at <<http://www.crcnetbase.com/doi/abs/10.1201/b12516-73>> (last visit 23 October 2012).
- HM Government, 2013. Trial Project Cockham Wood. [online] Available at <https://www.gov.uk/government/uploads/system/uploads/attachment_data/file/210120/Procurement-Trial-Project-Case-Study-MoJ-Cookham-Wood.pdf> (last visit 19 July 2013).
- Hopper, M., 2012. BIM Anatomy. An investigation into implementation prerequisites. Design Metodology, Department of Construction Science, Lund University, Faculty of Engineering. Available at <<http://www.sbuf.se/ProjectArea/Documents/ProjectDocuments/6d491864-cc7b-41bd-bfe0-703c9218e537%5CFinalReport%5CSBU%20F%202012187%20Licentiatavhandling%20Martin%20Hooper%20BIM%20Anatomy.pdf>> (last visit 20 June 2013).
- Ilozor, B. D. and Kelly, D. J., 2012. Building Information Modeling and Integrated Project Delivery in the Commercial Construction Industry: A Conceptual Study. Journal of Engineering, Project, and Production Management, 2(1), pp. 23–36. Available at <http://www.ppml.url.tw/EPPM_Journal/volumns/02_01_January_2012/ID_013_2_1_23_36.pdf> (last visit 22 February 2013).
- Jardim-Goncalves, R. and Grilo, A., 2010a. SOA4BIM: Putting the building and construction industry in the Single European Information Space. Automation in Construction, 19(4), pp. 388–397. Available at <<http://www.sciencedirect.com/science/article/pii/S0926580509001794>> (last visit 28 December 2012).
- Jardim-Goncalves, R. and Grilo, A., 2010b. Building information modelling and interoperability. Automation in Construction, 19(4), p. 387. Available at <<http://www.sciencedirect.com/science/article/pii/S0926580509001782>> (last visit 28 December 2012).
- JCT, 2013. BIM The Focus at JCT Parliamentary Reception, [online] 3 May 2013. Available at <<http://www.jctltd.co.uk/news.aspx?NewsArticleId=37>> (last visit 23 July 2013).
- Jonte EPM Tecnology, 2009. Vestbanen BIM Manager. User Guide v0.7. Oslo: Jonte EPM Tecnology As. Available at <<http://www2.epmtech.jotne.com/download/EDMmodelServerIFC/InstModelServerManager/Vestbanen%20BIM%20Manager%20Guide.pdf>> (last visit 13 December 2012).
- Kairos Future, 2011. 10 truths about BIM. Available at <<http://www.wspgroup.com/en/wsp-group-bim/10-truth-bim/>> (last visit 20 July 2013).

- Khemlani, L., 2012a. Around the World with BIM. AECbytes. Available at <<http://www.aecbytes.com/feature/2012/Global-BIM.html>> (last visit 14 April 2013).
- Khemlani, L., 2012b. AEC Exhibitor Highlights from Autodesk University 2012. AECbytes. Available at <http://www.aecbytes.com/feature/2012/AU2012_Exhibitors.html> (last visit 23 April 2013).
- Khemlani, L., 2012c. Exploring the National BIM standard. AECbytes. Available at <<http://www.aecbytes.com/buildingthefuture/2012/NBIMS.html>> (last visit 25 June 2013).
- Khemlani, L., 2008. Autodesk NavisWorks 2009. AECbytes. Available at <<http://www.aecbytes.com/review/2008/NavisWorks2009.html>> (last visit 11 May 2013).
- Kiviniemi, A., 2010. How to Define Design and Life Cycle Information Requirements for BIM based processes. In: N. Gilkinson, 2010. Clients and BIM: how to realise the benefits. The Salford Centre for Research & Innovation (SCRI) Forum. Available at <http://www.scri.salford.ac.uk/resources/uploads/File/Summary_Report_BIMandClients_Oct2010.pdf> (last visit 28 December 2012).
- Kiviniemi, A., 2013. Public clients as the driver for open BIM adoption-how and why UK government wants to change the construction industry? Conference at Clareon Hotel Airlanda airport, Open BIM. Stockholm, Sweden 22 April 2013. Available at <http://www.openbim.se/Aktuellt/Nyheter/~-/media/Files_OpenBIM/Event/130422/130422_Arto_Kiviniemi_presentation.ashx> (last visit 13 July 2013).
- Kiviniemi, M., Sulankivi, K., Kähkönen, K., Mäkelä, T. and Merivirta, M. L., 2011. BIM-based Safety Management and Communication for Building Construction. VTT Research Notes 2597. Available at <<http://www.vtt.fi/inf/pdf/tiedotteet/2011/T2597.pdf>> (last visit 16 May 2013).
- Koppinen, T. and Lahdenperä, P., 2004. The current and future performance of road project delivery methods. Espoo: VTT Publications 549. VTT. Available at <<http://www.vtt.fi/inf/pdf/publications/2004/P549.pdf>> (last visit 26 October 2012).
- Kulusjärvi, H. and Widney, J., 2012. Solibri Introduces Solibri Model Checker v7.1, delivering enhanced features for BIM QA/QC usage, expanded support for selected Building Codes and Public BIM Requirements. [online] Solibri. Available at <<http://www.solibri.com/press-releases/solibri-model-checker-v7-1-is-available.html>> (last visit 1 March 2013).
- Kvarsvik, O. K., 2010a. Architect competition. New National Museum at Vestbanen. BIM requirements – and results.... [online] BuildingSmart. Available at <http://www.buildingsmart.no/filedepot_download/2936/94> (last visit 4 January 2013).
- Kvarsvik, O. K., 2010b. Statsbygg BIM policy and BIM requirements for the International Architectural Competition for a new National Museum in Oslo. In: N. Gilkinson, 2010. Clients and BIM: how to realise the benefits. The Salford Centre for Research & Innovation (SCRI) Forum. Available at <<http://www.scri.salford.ac.uk>>

- resources/uploads/File/SummaryReport_BIMandClients_Oct2010.pdf> (last visit 28 December 2012).
- Laakso, M. and Kiviniemi, A., 2012. The IFC standard – A review of history, development and standardization, *ITcon*, 17, pp. 134–161. Available at <<http://www.itcon.org/2012/9>> (last visit 17 January 2013).
- Laakso, M., 2012a. Public Procurement Influence on IT Standardisation: A Case from the Construction Industry. In: *UNDERPINN, Demand, Innovation and Policy: Underpinning Policy Trends with Academic Analysis*. Abstract Booklet. Manchester 22–23 March 2012. Available at <<https://underpinn.portals.mbs.ac.uk/Portals/70/docs/120410%20MloIR%20Conference%20Abstract%20Booklet%20v7.0.pdf>> (last visit 17 January 2013).
- Laakso, M., 2012b. Public Procurement Influence on IT Standardisation: A Case from the Construction Industry. In: *UNDERPINN, Demand, Innovation and Policy: Underpinning Policy Trends with Academic Analysis*. Manchester 22–23 March 2012. Available at <https://underpinn.portals.mbs.ac.uk/Portals/70/docs/Laakso_Presentation.pdf> (last visit 17 January 2013).
- LACCD, 2001. LACCD Building Information Modeling Standards For Design-Bid Build Projects. Version 3.0. Los Angeles: LACCD BIMS. [online] Available at <https://docs.google.com/file/d/0B-AI8bWrZtw_YmFkNDZkZGltZjhiNy00MzkwLTg3MTgtZDczMDNmNzAxY2Y0/edit?hl=en_US&pli=1> (last visit 4 January 2013).
- Lahdenperä, P., 2001. Design-Build Procedures. Introduction, illustration and comparison of U.S. modes. Espoo: VTT Publications 452. VTT. Available at <<http://www.vtt.fi/inf/pdf/publications/2001/P452.pdf>> (last visit 26 October 2012).
- Lahdenperä, P., 2008. Financial analysis of project delivery systems. Road projects' operational performance data revisited. Helsinki: VTT Research Notes 2445. VTT. Available at <<http://www.vtt.fi/inf/pdf/tiedotteet/2008/T2445.pdf>> (last visit 26 October 2012).
- Lahdenperä, P., 2012. Making sense of the multi-party contractual arrangements of project partnering, project alliancing and integrated project delivery. *Construction Management and Economics*, 30, pp. 57–79.
- Lindblad, H., 2013. Study of the implementation process of BIM in construction projects. Analysis of the barriers limiting BIM adoption in the AEC-industry. Master Thesis. Royal Institute of Technology (KTH), School of Architecture and the Built Environment (ABE), Real Estate and Construction Management. Stockholm. Available at <<http://kth.diva-portal.org/smash/get/diva2:633132/FULLTEXT01>> (last visit 11 July 2013).
- Liu, T. and Hsieh, T., 2011. BIM-based Government Procurement System- The Likely Development in Taiwan. In: *IAARC Publications, Proceedings of the 28th ISARC*. Seoul, Korea 29 June – 2 July 2011. pp. 758–763. Available at <<http://www.iaarc.org/publications/fulltext/S22-6.pdf>> (last visit 13 November 2012).

- Lowe, R. H. and Muncey, J. M., 2009. ConsensusDOCS 301 BIM Addendum, Construction Lawyer, 29(1). American Bar Association. Available at <<http://www.agc.org/galleries/contracts/ConsensusDOCS%20301%20BIM%20Addendum%20Article.pdf>> (last visit 25 January 2013).
- Masterspec, 2012. New Zealand National BIM Survey 2012. Construction Information Ltd. Available at <<http://www.masterspec.co.nz/news-reports/p1/new-zealand-national-bim-survey-report-2012-i748c31a1-a451-40c9-bd1c-2aba8e621916-1243.htm>> (last visit 14 June 2013).
- McAuley, B., Hore, A., West, R. and Kehily, D., 2012. Addressing the Need to Reform Construction Public Procurement in Ireland through the Implementation of Building Information Modelling, Proceedings of the 1st ASEA-SEC International Conference on Research, Development and Practice in Structural Engineering and Construction. Perth Western Australia, 28th November - 2nd December 2012. Available at <<http://arrow.dit.ie/cgi/viewcontent.cgi?article=1035&context=beschrecon>> (last visit 26 November 2012).
- Mohamad, R., Hamdan, A. R., Othman, Z., A. and Noor, N. M. M., 2011. Modelling Ontology for Supporting Construction Tender Evaluation Process, 2011 International Conference on Semantic Technology and Information Retrieval, Putrajaya, Malaysia, 28–29 June 2011, pp. 285–288. Available at <<http://ieeexplore.ieee.org/stamp/stamp.jsp?tp=&arnumber=5995803>> (last visit 26 November 2012).
- National Institute of Building Science, 2007. United States National Building Information Modeling Standard. Version1 – Part 1: Overview, Principles, and Methodologies. Available at <http://www.wbdg.org/pdfs/NBIMSv1_p1.pdf> (last visit 15 June 2013).
- NASA, 2011. Building Information Modeling scope of services and requirements for construction contractor in a Design-Bid-Build process. 16 March 2011. Available at <<http://www.hq.nasa.gov/office/codej/codejx/Assets/Docs/2-2011-0316%20Final%20DBB%20Construction%20BIM%20RFP.pdf>> (last visit 2 June 2013).
- Nguyen, T. and Kim, J., 2011. Building Code Compliance Checking using BIM Technology. Proceedings of the 2011 Winter Simulation Conference. Phoenix, AZ, USA 11–14 December 2011. Pp. 3400–3405. Available at <http://delivery.acm.org/10.1145/2440000/2431922/p3400-nguyen.pdf?ip=130.188.8.27&acc=ACTIVE%20SERVICE&CFID=180565531&CFTOKEN=23994100&__acm__=1360928364_28ec7ece45bca072624d795040fac599> (last visit 15 February 2013).
- Page, I. C. and Curtis, M. D., 2012. Building Industry Performance Measures – Part One. Study Report SR 267 (2012). Wellington, New Zealand: Building Research Association of New Zealand. Available at <http://www.branz.co.nz/cms_show_download.php?id=2be18e9778375eab939ff3c96a520b5ff9dabfc9> (last visit 13 June 2013).
- Petäjänieniemi, P. and Lahdenperä, P., 2012a. Alliance contracting –one for all and all for one (Finland). In: European Infrastructure Procurement Symposium, Conflict between Institutional Frameworks and Managerial Project Practice. Copenhagen,

- Denmark, 8 May 2012, pp. 12–15. Available at <<http://www.netlipse.eu/media/53848/EIPS.pdf>> (last visit 26 March 2013).
- Petäjämäki, P. and Lahdenperä, P., 2012b. Alliance contracting: How we make it in Finland. In: European Infrastructure Procurement Symposium, Conflict between Institutional Frameworks and Managerial Project Practice. Copenhagen, Denmark, 8 May 2012. Available at <<http://www.netlipse.eu/media/49218/eips%202012%2005%2008%20alliance%20contracting.pdf>> (last visit 26 March 2013).
- Philp, D., 2012. BIM and the UK Construction Strategy, National BIM Report 2012. Available at <<http://www.thenbs.com/pdfs/NBS-NationalBIMReport12.pdf>> (last visit 26 November 2012).
- Porwal, A. and Hewage, K. N., 2013. Building Information Modeling (BIM) partnering framework for public construction projects. *Automation in Construction*, 31, pp. 204–214. Available at <<http://www.sciencedirect.com/science/article/pii/S0926580512002439>> (last visit 25 January 2013).
- Public Statement, 2008. Statement of intention to support Building Information Modeling with open standards. Washington, 17 January 2008. Available at <http://www.gsa.gov/graphics/pbs/Statement_of_Intention-BIM_FINAL.pdf> (last visit 14 November 2012).
- Public Statement, 2011. First Amendment to Statement of intention to support Building Information Modeling with open standards. Washington, 19 September 2011. Available at <http://www.gsa.gov/graphics/pbs/Statement_of_Intention_to_support_Open_Standards_2011.pdf> (last visit 14 November 2012).
- Quirk, V., 2012. A Brief History of BIM/ Michael S. Bergin. *Archdaily* [online] 7 December 2012. Available at <<http://www.archdaily.com/302490/a-brief-history-of-bim/>> (last visit 17 August 2013).
- Racca, G., 2012. The Electronic Award and Execution of Public Procurement. *IUS Publicum Network Review*. Available at <http://papers.ssrn.com/sol3/papers.cfm?abstract_id=2229253> (last visit 13 August 2013).
- Racca, G. and Cavallo Perin, R., 2012. Integrity and efficiency in sustainable public contracts. In: Y. Marique, Integrity and efficiency in sustainable public contracts. Corruption, conflicts of interest, favouritism and inclusion of non-economic criteria in the award and execution of public contracts. Workshop. Paris, 19 December 2012. Available at <http://www.public-contracts.net/inhalte/Report_Paris_2012.pdf> (last visit 13 August 2013).
- Raisbeck, P., Millie, R. and Maher, A., 2010. Assessing integrated project delivery: a comparative analysis of IPD and alliance contracting procurement routes. In: Egbu, C. (Ed), Proceedings 26th Annual ARCOM Conference, 6–8 September 2010, Leeds, UK, Association of Researchers in Construction Management. Vol. 2, pp. 1019–1028. Available at <http://www.arcom.ac.uk/-docs/proceedings/ar2010-1019-1028_Taisbeck_Millie_and_Maher.pdf> (last visit 19 May 2013).

- RIBA, 2012. Building Ladders of Opportunity. How reforming construction procurement can drive growth in the UK economy. Available at <<http://www.architecture.com/Files/RIBAHoldings/PolicyAndInternationalRelations/Policy/PublicAffairs/2012/BuildingLaddersofOpportunity.pdf>> (last visit 30 July 2013).
- Rijksgebouwendienst, 2012. Rgd BIM Standard. Version 1.0.1. 1 July 2012. Available at <http://www.rgd.nl/fileadmin/redactie/Onderwerpen/Diensten/BIM/Rgd_BIM_Standard_v1_0_1_EN_v1_0_2_.pdf> (last visit 22 June 2013).
- Roginski, D., 2011. Quantity Takeoff process for bidding stage using BIM tools in Danish Construction Industry. Master Thesis. Technical University of Denmark. Available at <<http://www.bim.byg.dtu.dk/upload/subsites/bim/04%20uddannelse/eksamensprojekter/master%20thesis%20quantity%20takeoff%20process%20for%20bidding%20stage%20using%20bim%20tools%20in%20danish%20construction%20industry.%20daniel%20roginski%20s091.pdf>> (last visit 15 February 2013).
- Salminen, K., 2013a. Projektipankisakin tarvitaan logistiikkaa. Rakennuslehti, 7 Feb. p. 11. In Finnish.
- Salminen, K., 2013b. Lähtötietoihin ei aina luoteta. Rakennuslehti, 7 Feb. p. 11. In Finnish.
- Salmon, J. L., 2012. Wicked IPD Procurement Programs: IPD & BIM Solutions Unleashed. [online] 5 June 2012, Autodesk User Group International (AUGI). Available at <<http://www.augi.com/library/wicked-ipd-procurement-programs-ipd-bim-solutions-unleashed>> (last visit 20 October 2012).
- Sanguinetti, P., Abdelmohsen, S., Lee, J., Lee, J., Sheward, H. and Eastman, C., 2012. General system architecture for BIM: An integrated approach for design and analysis. *Advanced Engineering Informatics*, 26(2), pp. 317–333. Available at <<http://www.sciencedirect.com/science/article/pii/S1474034611001108>> (last visit 1 November 2012).
- Saxon, R. G., 2013. Growth through BIM. London: Construction Industry Council. Available at <<http://www.cic.org.uk/admin/resources/publications/growth-through-bim-final-1.pdf>> (last visit 18 May 2013).
- SCA, 2013. Building Information Modeling Guidelines and Standards for Architects and Engineers. Version 1.0 dated 01/11/2013. New York School Construction Authority. Available at <http://www.nycsca.org/Business/WorkingWithTheSCA/Design/Manuals/SCA_BIM_Standards_Manual.pdf> (last visit 30 July 2013).
- Senaatti and SYKE, 2010a. Viikki Synergy Building. Finnish Environment Institute's Eco-Efficient Office Building, Competition programme. Available at <http://www.senaatti.com/tiedostot/Competition_programme_revB_namecorr.pdf> (last visit 12 March 2013).
- Senaatti and SYKE, 2010b. Viikki Synergy Building Competition. Questions and answers 1 20120.06.22. Available at <http://www.senaatti.com/tiedostot/Synergy_questions_and_answers_2010-06-21.pdf> (last visit 13 March 2013).

- Senaatti and SYKE, 2010c. Viikki Synergy Building Competition. Contract notice of Synergy building. Available at <<http://www.ymparisto.fi/download.asp?contentid=123376&lan=en>> (last visit 15 March 2013).
- Senaatti and SYKE, 2010d. Viikki Synergy Building Competition. Appendix to minutes of the Competition jury, competition entries. Competition winner: Apila. Available at <https://usercontent.gripworkfiles.com/88238/fi/file/Kilpailuehdotukset_Synergiatalo_Apila.pdf> (last visit 15 March 2013).
- Skandhakumar, N., Reid, J., Dawson, E., Drogemuller, R. and Salim, F., 2012. An Authorization Framework using Building Information Models. *The Computer Journal*, 55(10), pp. 1244–1264.
- Soto, C. and Carlsson, M., 2013. Object Interaction Query: A context awareness tool for evaluating BIM components' interactions. Available at <http://bimforum.org/wp-content/uploads/2013/01/2013-01-11Tp_-_Soto.pdf> (last visit 21 August 2013).
- Statsbygg, 2010a. National Museum at Vestbanen – Competition programme. Available at <http://statsbygg.no/FilSystem/files/prosjekter/nasjonalmuseet/Program_fase2_engelsk.pdf> (last visit 1 November 2012).
- Statsbygg, 2010b. Open Planning and design competition, The National Museum of art, architecture and design – Jury report. Available at <<http://statsbygg.no/FilSystem/files/konkurransen/fase2/NasjmusJuryReportEng.pdf>> (last visit 1 November 2012).
- Statsbygg, 2011. Statsbygg Building Information Modelling Manual Version 1.2 (SBM1.2). Oslo, Norway. Available at <<http://www.statsbygg.no/FilSystem/files/prosjekter/BIM/StatsbyggBIMmanualV1-2Eng2011-10-24.pdf>> (last visit 1 March 2013).
- Steffensen, M., 2012. The Danish Digital Construction Initiative. Danish Building and Property Agency. Available at <http://www.statybininkai.lt/Files/conf/3_dk%20agency%20digital%20construction-morten%20steffensen.pdf> (last visit 4 June 2013).
- Succar, B., 2009. Building information modelling framework: A research and delivery foundation for industry stakeholders. *Automation in Construction*, 18(3), pp. 357–375. Available at <<http://www.sciencedirect.com/science/article/pii/S0926580508001568#>> (last visit 22 February 2013).
- Sulankivi, K., Mäkelä, T. and Kiviniemi, M., 2009. Tietomalli ja työmaan turvallisuus. Tutkimusraportti, VTT-R-01003-09. VTT's TurvaBIM. Research report. Available at <http://www.vtt.fi/files/projects/turvabim/turvabim_loppuraportti_090312.pdf> (last visit 16 May 2013). In Finnish.
- Sulankivi, K. and Kiviniemi, M., 2011. BIM-based falling prevention planning. BIM Safety research project, Pilot 1. VTT's BIM Safety research project (<http://www.vtt.fi/sites/bimsafety/index.jsp>). Last visit 16 May 2013. In Finnish. Available at <http://www.vtt.fi/files/sites/bimsafety/bim_safety_falling_prevention_planning_pilot1.pdf> (last visit 16 May 2013).
- Sulankivi, K., Zhang, S., Teizer, J., Eastman, C. M., Kiviniemi, M., Romo, I. and Granholm, L., 2013. Utilisation of BIM-based Automated Safety Checking in

- Construction Planning. In: Proceeding of 19th World Building Conference 2013, Brisbane, Australia, 5–9 May 2013. Construction and Society. Queensland University of Technology.
- Svidt, K. and Christiansson, P., 2008. Requirements on 3D building information models and electronic communication – experiences from an architectural competition. In: Leonardo Rischmoller, 25th International Conference on Information Technology in Construction. Santiago de Chile, July 15–17 2008. Pp. 231–238. Available at <<http://itc.scix.net/data/works/att/w78-2008-4-04.pdf>> (last visit 1 November 2012).
- Svidt, K. and Karlshøj, J., 2005. Bygherrekrav vedrørende 3D-modeller, visualisering og simulering: Erfaringer fra første afprøvningsprojekt, Idékonkurrence for Fibigerområdet. Aalborg Universitet. Det Digitale Byggeri. Erhvervs- og Byggestyrelsen, København, 2005. Available at <http://www.it.civil.aau.dk/it/reports/2005_b3d_afprovning.pdf> (last visit 8 February 2013). In Danish.
- Tietomallihankkeen tilaajaohje 1.0. (unpublished draft, May 7 2013, in Finnish).
- Turner, A. E., 1990. Building procurement. London: Macmillan Building and Surveying Series.
- Udom, K., 2012a. BIM: mapping out the legal issues, [online] February 2012. NBS. Available at <<http://www.thenbs.com/topics/BIM/articles/bimMappingOutTheLegalIssues.asp>> (last visit 7 January 2013).
- Udom, K., 2012b. NBS and Kennedy LLP legal counsels' breakfast meeting on BIM legal issues, [online] July 2012. NBS. Available at <<http://www.thenbs.com/topics/BIM/articles/legalCounselsBreakfastMeeting.asp>> (last visit 9 January 2013).
- Udom, K., 2012c. New procurement methods coming to a project near you, [online] April 2012. NBS. Available at <<http://www.thenbs.com/topics/contractsLaw/articles/newProcurementMethods.asp>> (last visit 19 March 2013).
- US Army Corps of Engineers, 2011. Building Information Modeling (BIM) Roadmap. Supplement 2 – BIM Implementation Plan for Military Construction Projects, Bentley Platform. Available at <<http://acwc.sdp.sirsi.net/client/search/asset/1002733>> (last visit 22 June 2013).
- Valadares Tavares, L., 2013. E-Public Procurement in Europe: Public Management, Technologies and Processes of Change, Proceedings of the 1st European Conference on e-Public Procurement (ECP), Barcelona, Spain, 20 March 2013. Available at <<http://www.scribd.com/doc/153124090/E-Public-Procurement-in-Europe-Public-Management-Technologies-and-Processes-of-Change>> (last visit 30 July 2013).
- Várkonyi, V., 2010. Next Evolution of BIM: Open Collaborative Design Across the Board. AECbytes Viewpoint #53. Available at <http://www.aecbytes.com/viewpoint/2010/issue_53.html> (last visit 22 February 2013).
- Vasu, K., 2011. An investigation into the potential level of implementation of Building Information Modelling (BIM) approach to enhance procurement process within construction industry in UK. Postgraduate Dissertation. School of Technology,

- University of Wolverhampton. Available at <<http://www.scribd.com/doc/79451394/Building-Information-Modelling-Dissertation>> (last visit 28 December 2012).
- Venugopal, M., Eastman, C. M., Sacks, R. and Teizer, J., 2012. Semantics of model views for information exchanges using the industry foundation class schema. *Advanced Engineering Informatics*, 26(2), pp. 411–428. Available at <<http://www.sciencedirect.com/science/article/pii/S1474034612000067>> (last visit 3 December 2012).
- Vianova Systems, 2013. Improved tenders using BIM. [online] 29 April 2013. Vianova Systems. Available at <http://www.vianovasystems.com/News/Improved-tenders-using-BIM#.UdKJI_mGHRm> (last visit 27 June 2013).
- Wong, A. K. D., Wong, F. K. W. and Nadeem, A., 2009. Comparative Roles of Major Stakeholders for the Implementation of BIM in Various Countries. Available at <<http://www.changingroles09.nl/uploads/File/Final.KD.Wong-KW.Wong-Nadeem.pdf>> (last visit 16 June 2013).
- Yan, H. and Damian, P., 2008. Benefits and Barriers of Building Information Modelling, 12th International Conference on Computing in Civil and Building Engineering. Beijing, China 16–18 October 2008. Available at <http://homepages.lboro.ac.uk/~cvpd2/PDFs/294_Benefits%20and%20Barriers%20of%20Building%20Information%20Modelling.pdf> (last visit 15 February 2013).

Title	The implementation of BIM within the public procurement A model-based approach for the construction industry
Author(s)	Marzia Bolpagni
Abstract	<p>Recently more and more Public Sectors have been paying close attention to save cost and, at the same time, improve efficiency. Usually, the Construction Industry has a relevant annual turnover, which represents an important part of the GDP for most of the EU countries and concerns in a large part the Public Sector. Thus, some Public Clients, such as UK, are adopting new strategies in order to improve the current situation. One of these strategies is Building Information Modelling (BIM), which forces all the parties involved in the process to adopt a collaborative approach reducing inefficiencies. Moreover, also the European Parliament is going to encourage the BIM adoption to 'modernise the procurement process and ensure greater efficiencies'. The EU Directive will be an important push to reform the EU Members' Public Construction Procurement.</p> <p>The aim of this M. Sc. Thesis is to analyse the possible implementation of BIM within the Public Procurement, especially how Model Checking can be applied within Tendering to verify the compliance between the Client's requirements and the bid's contents.</p> <p>The first part presents both the most widespread Public Procurement Methods, such as Design-Bid-Build (DBB), Design-Build (DB), Construction Management (CM), Design-Build-Operate (DBO) and Design-Build-Finance-Operate (DBFO), as well as innovative kinds of Procurement Procedures, such as Integrated Project Delivery (IPD), Project Alliancing (PA), Cost Led Procurement (CLP), Integrated Project Insurance (IPI), Two Stage Open Book and Early BIM Partnering (EBP). A paragraph is dedicated to the drivers and the barriers of e-Procurement, which should be part of the Public Procurement strategy. Later, the main issues related to BIM are shown, such as current BIM Authorised Uses and Permitted Purposes, Interoperability and OpenBIM, along with BIM implementation in Public Sector of several countries (Singapore, USA, Finland, UK, Norway, Denmark, Netherlands, South Korea, Hong Kong, Australia, New Zealand, Iceland, Estonia, Sweden, Germany, China, Ireland, Taiwan and Italy) and the relation between e-Procurement and BIM. Additionally, the principal possibilities and challenges dealing with BIM adoption are presented. The following chapter is dedicated to the investigation of the possible BIM implementation in Tendering. Even if integrated procedures, such as IPD, seem to be the most suitable with BIM, a discussion of the BIM role in DBB and DB or Design Competitions is carried out, showing the main Client's requirements, benefits for Bidders and Clients, together with limitations and possibilities. Thereafter, a paragraph illustrates Model Checking in the evaluation of design proposals. First, a short description of the main commercial software, which can support BIM-based tendering (such as Solibri Model Checker (SMC), EDM Model Server, dRofus, Affinity, dProfiler, Autodesk NavisWorks, Tekla BIMsight, Bentley Projectwise Navigator, Riuska, Autodesk Ecotect, EasyBIM, Vico Cost Planner and Mitchell Brandtman) is provided. Later, a list of the most common operations, which nowadays a Client could check in a BIM tender together with the main commercial software available, is shown. More emphasis has been given to the software SMC, since this study was mostly carried out testing it and some new rules have been created. Moreover, a comparison between the published version of Statsbygg Building Information Modelling Manual and the translated rule-sets in SMC is carried out to understand the possibilities and limitations of the software in order to check Client's requirements. Another paragraph describes five case studies presented in literature to investigate the possible implementation of BIM in Tendering (cluster of University Buildings in Denmark, National Museum at Vestbanen in Oslo, Synergy Building in Helsinki, Office and Shopping Space in Canada and prison Cookham Wood in Rochester). Finally, the possible implementation of BIM in Tendering is tested on an Italian case study, a Theatre in Rimini, and a simulation of e-Tendering, adopting i-Faber e-Procurement platform, is investigated.</p> <p>This study shows that nowadays BIM, and especially Model Checking, can be a useful support for Public Construction Procurement only if the Public Clients hold the control of the process and they are able to define clear requirements.</p>
ISBN, ISSN	ISBN 978-951-38-8058-3 (URL: http://www.vtt.fi/publications/index.jsp) ISSN-L 2242-1211 ISSN 2242-122X (Online)
Date	October 2013
Language	English, Italian and Finnish abstract
Pages	233 p.
Keywords	Building Information Modelling (BIM), Public Procurement Methods, Tendering, Model Checking, e-Procurement
Publisher	VTT Technical Research Centre of Finland P.O. Box 1000, FI-02044 VTT, Finland, Tel. 020 722 111

Titolo	L'utilizzo del BIM negli Appalti Pubblici Un Approccio basato sulla Modellazione Digitale per il Settore Edile
Autore	Marzia Bolpagni
Abstract	<p>Ultimamente nel Settore Pubblico si assiste a un'attenzione sempre più accesa nel contenere le spese così come nella ricerca di processi più efficienti. Ogni anno il Settore delle Costruzioni, e in particolar modo il Settore Pubblico, registra un importante giro d'affari che costituisce buona parte del PIL di molte stati europei. Per questo motivo alcuni Governi, come quello britannico, stanno sviluppando nuove strategie per migliorare i processi tradizionali. Una di queste strategie è il Building Information Modelling (BIM), che spinge tutte le parti coinvolte nel processo ad adottare un atteggiamento collaborativo riducendo le inefficienze. Il Parlamento Europeo, inoltre, ha intenzione di incoraggiarne l'utilizzo per modernizzare l'iter degli appalti e garantire una maggiore efficienza. La direttiva europea sarà un importante stimolo per rinnovare gli Appalti Pubblici degli Stati Membri.</p> <p>Lo scopo di questa Tesi è analizzare l'utilizzo del BIM negli Appalti Pubblici e, in particolare, studiare come il Model Checking, cioè la verifica di modelli BIM, possa essere applicato in fase di gara per verificare la conformità delle proposte dei concorrenti rispetto alle richieste della committenza.</p> <p>Un primo capitolo è dedicato agli appalti pubblici di lavori più diffusi come l'appalto di sola esecuzione (DBB), appalti integrati (DB), contratti di concessione (DBO e DBFO) e Construction Management. Accanto a queste tipologie sono presentati anche alcuni approcci innovativi come l'Integrated Project Delivery (IPD), Project Alliancing (PA), Cost Led Procurement (CLP), Integrated Project Insurance (IPI), Two Stage Open Book ed Early BIM Partnering (EBP). Un paragrafo presenta i principali aspetti legati agli Appalti Elettronici (e-Procurement), che dovrebbero rientrare nelle strategie delle stazioni appaltanti. Il capitolo successivo descrive le principali caratteristiche del BIM come la sua storia, i campi di applicazione, l'interoperabilità e l'OpenBIM, oltre al suo sviluppo in diversi paesi (Singapore, USA, Finlandia, Regno Unito, Norvegia, Danimarca, Olanda, Corea del Sud, Hong Kong, Australia, Nuova Zelanda, Islanda, Estonia, Svezia, Germania, Cina, Irlanda, Taiwan e Italia) e al legame tra e-Procurement e BIM. Inoltre, sono discussi le principali potenzialità e limiti legati all'implementazione del BIM. Il capitolo seguente studia come il BIM potrebbe essere utilizzato in fase di gara. Sebbene approcci integrati, come l'IPD, siano più vantaggiosi in presenza di un processo BIM, in questa sede sono analizzati i casi più tradizionali di appalti di sola esecuzione (DBB), appalti integrati (DBB) e concorsi di architettura. Particolare attenzione è data alle esigenze dei committenti, ai vantaggi per i concorrenti e i committenti e alle potenzialità e limitazioni di questo approccio. In seguito, un paragrafo illustra il ruolo del Model Checking all'interno della valutazione delle offerte presentando i principali software disponibili sul mercato (come Solibri Model Checker (SMC), EDM Model Server, dRofus, Affinity, dProfiler, Autodesk NavisWorks, Tekla BIMsight, Bentley Projectwise Navigator, Riuska, Autodesk Ecotect, EasyBIM, Vico Cost Planner e Mitchell Brandtman). Inoltre, sono studiate le principali operazioni che una stazione appaltante può compiere per verificare la conformità delle offerte e i principali software disponibili, soffermandosi principalmente su SMC, con il quale sono stati eseguiti dei test e create nuove regole. Per meglio comprendere le potenzialità e criticità di SMC nel tradurre in rulesets regole scritte, si è comparata la versione cartacea del manuale BIM di Statsbygg con il relativo set di regole (rulesets) presente SMC. Il paragrafo successivo illustra cinque casi di studio presenti in letteratura dove il BIM è stato utilizzato in fase di gara (Stabili Universitari in Danimarca, Museo Nazionale a Oslo, Edificio a Helsinki, Uffici e Spazi commerciali in Canada e prigione Cookham Wood a Rochester). Infine, l'utilizzo del BIM in fase di gara è stato implementato su un progetto italiano, il teatro Galli di Rimini, e si è utilizzata la piattaforma di e-Procurement per la pubblica amministrazione di i-Faber.</p> <p>Questo studio rivela che il BIM, e in particolar modo gli strumenti di Model Checking, possono essere fin da ora un valido supporto per gli Appalti Pubblici di lavori solo se le stazioni appaltanti detengono il controllo del processo e impostano la gara in modo chiaro e dettagliato.</p>
ISBN, ISSN	ISBN 978-951-38-8058-3 (URL: http://www.vtt.fi/publications/index.jsp) ISSN-L 2242-1211 ISSN 2242-122X (Online)
Anno	Ottobre 2013
Lingua	Inglese, abstract in italiano e finlandese
Numero di pagine	233 p.
Parole chiave	Building Information Modelling (BIM), Appalti Pubblici di lavori, Fase di gara, Model Checking, Appalti Elettronici
Editore	VTT Technical Research Centre of Finland P.O. Box 1000, FI-02044 VTT, Finland, Tel. 020 722 111

Nimeke	Tietomallin käyttö julkisissa hankinnoissa BIM-pohjainen lähestymistapa rakennusteollisuudelle
Tekijä(t)	Marzia Bolpagni
Tiivistelmä	<p>Julkinen sektori on viime aikoina alkanut kiinnittää yhä enemmän huomiota kustannusten säästämiseen ja samalla tehokkuuden parantamiseen. Rakennusteollisuuden tuotannon arvo on tärkeä osa bruttokansantuotetta (BKT) useimmissa EU-maissa, ja merkittävä osa siitä muodostuu julkiselta sektorilta. Tästä syystä rakentamisen julkiset tilaajat esimerkiksi Isonsa-Britanniassa kehittävät uusia strategioita nykyisen tilanteen parantamiseksi. Yksi näistä strategioista on rakentamisen tietomallinnus (Building Information Modelling, BIM), joka pakottaa kaikki prosessin osapuolet omaksumaan yhteistyöhön perustuvan työskentelytavan, joka vähentää tehottomuutta. Lisäksi myös Euroopan parlamentti tulee kannustamaan tietomallien käyttöön ottoon "hankintaprosessien nykyaikaistamiseksi ja tehokkuuden lisäämiseksi". Kyseinen EU-direktiivi tulee olemaan tärkeä aloite EU:n jäsenmaiden julkisen rakentamisen hankintojen uudistamiseksi.</p> <p>Tämän opinnäytetyön tavoitteena on analysoida tietomallin (BIM) mahdollista käyttöä julkisissa hankinnoissa, erityisesti miten BIM-pohjaista mallin tarkistamista voidaan käyttää tarjousvaiheessa tilaajan vaatimusten ja ehdotusten sisällön vastaavuuden varmistamiseen.</p> <p>Ensin esitetellään yleisimmin käytetyt julkiset hankintamenetelmät, kuten perinteinen hankintamenetelmä (Design-Bid-Build DBB), suunnittelu-toteutus (Design-Build DB), projekti johto (Construction Management CM), elinkaarimallit (Design-Build-Operate DBO ja Design-Build-Finance-Operate DBFO) sekä uusia innovatiivisia hankintamenettelyjä, kuten Integrated Project Delivery (IPD), Project Alliancing (PA), Cost Led Procurement (CLP), Integrated Project Insurance (IPI), Two Stage Open Book ja Early BIM Partnering (EBP). Yksi luku keskittyy sähköisen hankinnan "draivereihin" ja esteisiin, joiden tulisi olla mukana julkisten hankintojen strategiassa. Tämän jälkeen esitetään tietomalleihin liittyvät keskeiset kysymykset, kuten mallien nykyinen käyttö, yhteensopivuus ja "OpenBIM", BIMin käyttöönotto julkisella sektorilla eri maissa (Singapore, USA, Suomi, Iso-Britannia, Norja, Tanska, Hollanti, Etelä-Korea, Hongkong, Australia, Uusi-Seelanti, Islanti, Viro, Ruotsi, Saksa, Kiina, Irlanti, Taiwan ja Italia) sekä sähköisen hankinnan ja tietomallien välinen yhteys. Lisäksi käsitellään tietomallien käyttöön ottoon liittyvät tärkeimmät mahdollisuudet ja haasteet. Seuraava luku käsittelee tietomallien mahdollista käyttöä tarjouskilpailuissa. Vaikka yhteistyöhön perustuvat menettelyt, kuten IPD, näyttävät olevan sopivin sopimusmalli tietomallia hyödyntävissä hankkeissa, keskustellaan tietomallin roolista perinteisessä (DBB) ja suunnittelu-toteutus (DB) -hankkeissa sekä suunnittelukilpailuissa. Tuloksina esitetään tietomallien käyttöön liittyvät tilaajan tärkeimmät vaatimukset sekä hyödyt tarjoajille ja tilaajalle, yhdessä mallin käyttöön liittyvien rajoitteiden ja mahdollisuuksien kanssa. Tämän jälkeen omassa luvussaan havainnollistetaan mallin tarkistamista suunnitelmaehdotusten arvioinnissa. Ensin kuvataan lyhyesti tärkeimmät kaupalliset ohjelmistot, joilla voidaan tukea BIM-pohjaista tarjouskilpailua (Solibri Model Checker (SMC), EDM Model Server, dRofus, Affinity, dProfiler, Autodesk NavisWorks, Tekla BIMsight, Bentley ProjectWise Navigator, RIUSKA, Autodesk Ecotect, EasyBIM, Vico Cost Planner ja Mitchell Brandtman). Tämän jälkeen esitetään yleisimmät toiminnot, jotka tilaaja voisi nykyisin tarkistaa BIM-pohjaisesta tarjouksesta käyttäen kaupallisia ohjelmistoja. Päähuomio on Solibri Model Checker -ohjelmassa, jota tutkimuksessa pääosin käytettiin testauksiin ja johon luotiin myös joitakin uusia tarkastussääntöjä. Lisäksi työssä on vertailtu Norjan Statsbyggin julkaisemia mallinnusohjeita (Building Information Modelling Manual) ja niitä vastaavia SMC-säännöstöjä, tavoitteena ymmärtää ohjelman mahdollisuuksia ja rajoitteita suunnitelmille tehtävässä tilaajan vaatimustenmukaisuuden tarkistuksessa. Erillisessä luvussa kuvataan viisi esimerkkihanketta, joiden avulla selvitettiin kirjallisuustutkimuksena tietomallin käyttömahdollisuuksia tarjouskilpailuissa (yliopistorakennusten kokonaisuus Tanskassa, National Museum at Vestbanen Oslossa, Synergiatalo Helsingissä, toimisto ja myymälätoimitila Kanadassa ja vankila Cookham Wood Rochester Englannissa). Lopuksi BIMin käytön mahdollisuuksia on tutkittu Italianlaisen Riminin teatterin korjaushankkeen tarjouskilpailussa, ja sähköisen tarjouskilpailun simulointi on toteutettu i-Faber-nimisellä sähköisen hankinnan alustalla.</p>
ISBN, ISSN	ISBN 978-951-38-8058-3 (URL: http://www.vtt.fi/publications/index.jsp) ISSN-L 2242-1211 ISSN 2242-122X (verkkojulkaisu)
Julkaisu aika	Lokakuu 2013
Kieli	Englanti, italian- ja suomenkielinen tiivistelmä
Sivumäärä	233 s.
Avainsanat	tietomallinnus, Building Information Modelling (BIM), julkiset hankinnat, tarjousprosessi, mallien tarkastaminen, sähköinen hankinta
Julkaisija	VTT PL 1000, 02044 VTT, Puh. 020 722 111

The implementation of BIM within the public procurement

A model-based approach for the construction industry

ISBN 978-951-38-8058-3 (URL: <http://www.vtt.fi/publications/index.jsp>)

ISSN-L 2242-1211

ISSN 2242-122X (Online)

