

**Jukka Hietaniemi, Johan Mangs &
Tuula Hakkarainen**

Burning of Electrical Household Appliances

An Experimental Study

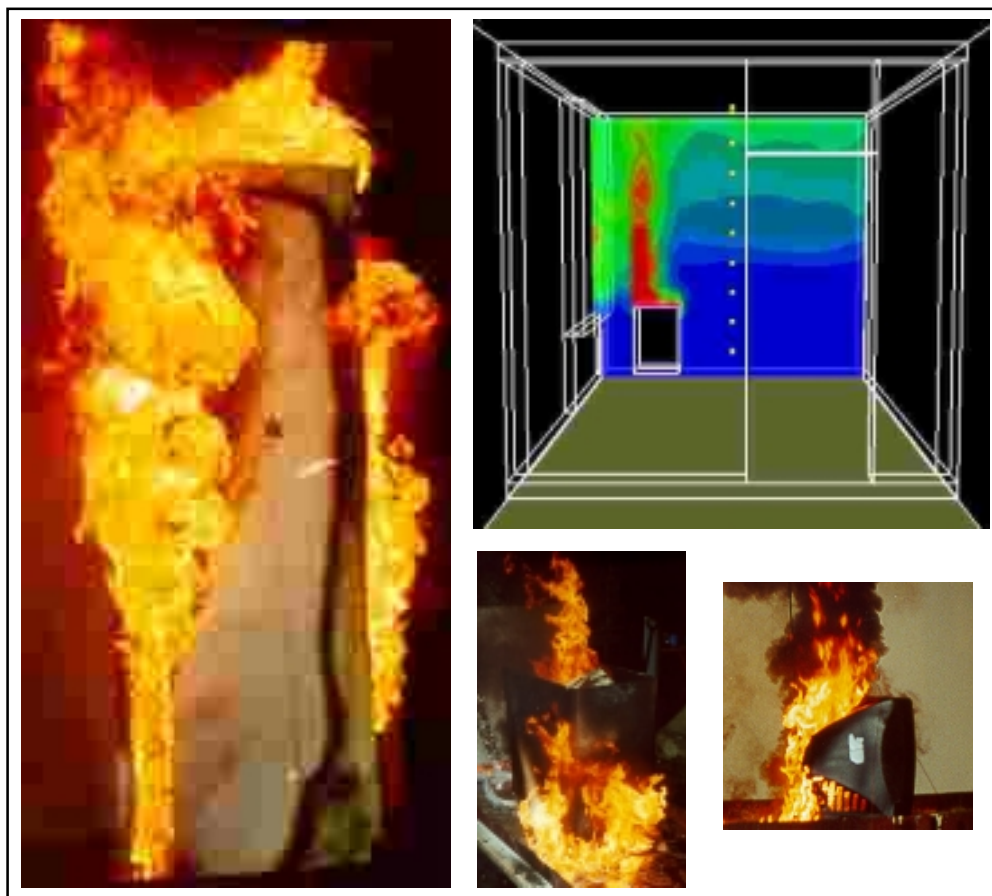

Burning of Electrical Household Appliances: An Experimental Study

Jukka Hietaniemi, Johan Mangs & Tuula Hakkarainen
VTT Building Technology



ISBN 951-38-5802-2 (soft back ed.)
ISSN 1235-0605 (soft back ed.)

ISBN 951-38-5803-0 (URL: <http://www.inf.vtt.fi/pdf/>)
ISSN 1455-0865 (URL: <http://www.inf.vtt.fi/pdf/>)

Copyright © Valtion teknillinen tutkimuskeskus (VTT) 2001

JULKAISIJA – UTGIVARE – PUBLISHER

Valtion teknillinen tutkimuskeskus (VTT), Vuorimiehentie 5, PL 2000, 02044 VTT
puh. vaihde (09) 4561, faksi (09) 456 4374

Statens tekniska forskningscentral (VTT), Bergsmansvägen 5, PB 2000, 02044 VTT
tel. växel (09) 4561, fax (09) 456 4374

Technical Research Centre of Finland (VTT), Vuorimiehentie 5, P.O.Box 2000, FIN-02044 VTT, Finland
phone internat. + 358 9 4561, fax + 358 9 456 4374

VTT Rakennus- ja yhdyskuntatekniikka, Rakennusfysiikka, talo- ja palotekniikka,
Kivimiehentie 4, PL 1803, 02044 VTT
puh. vaihde (09) 4561, faksi (09) 456 4815

VTT Bygg och transport, Byggnadsfysik, fastighets- och brandteknik,
Stenkarlsvägen 4, PB 1803, 02044 VTT
tel. växel (09) 4561, fax (09) 456 4815

VTT Building and Transport, Building Physics, Building Services and Fire Technology,
Kivimiehentie 4, P.O.Box 1803, FIN-02044 VTT, Finland
phone internat. + 358 9 4561, fax + 358 9 456 4815

Technical editing Leena Ukaskoski

Otamedia Oy, Espoo 2001

Hietaniemi, Jukka, Mangs, Johan & Hakkarainen, Tuula. Burning of Electrical Household Appliances: An Experimental Study. Espoo 2001. Technical Research Centre of Finland, VTT Tiedotteita – Meddelanden – Research Notes 2084. 60 p. + app. 23 p.

Keywords combustion, fire tests, fire safety, electric equipment, electric devices, households appliances, smoke, heat loss, ignition, TV, washing machines, dishwashers, refrigerators

Abstract

Burning characteristics of electrical household appliances of four different types, TV sets, washing machines, dishwashers and refrigerator-freezers, have been studied experimentally. Results obtained comprise rate of heat release, mass loss and generation of smoke and some chemical substances as well as the quantities derived from these data such as the effective heat of combustion. The experiments are comprehensively documented by written records of events and photographs.

High intensities of burning were detected. The highest rates of heat release (RHR), up to 2000 kW, were found for refrigerator-freezers. The peak RHR values for the other apparatuses were: dishwashers 350–750 kW, washing machines 300–450 kW and TVs 250–300 kW. Generally, the development of the burning of the apparatuses towards full burning has two phases. The first phase involves low-RHR incipient burning and during the second phase RHR grows rapidly towards the peak values. TV set fires develop rapidly: the first phase lasts ca. 1,5–3 minutes and, after it, the peak RHR value may be reached within 1–1,5 minutes from the initiation of the rapid RHR growth. For washing machines the period of incipient burning was rather long, 10–20 minutes depending on the way the apparatus was ignited (ignition in the motor space or at the control panel). For the dishwashers the delay was 5–10 minutes. A similar delay was found also in three refrigerator-freezer experiments. In one refrigerator-freezer experiment, the delay time was clearly shorter, only 2–3 minutes.

A computational analysis of the development of room fires originating from ignited electrical household appliances was conducted to study the significance of the measured burning characteristics. The RHR of refrigerator-freezers is so high that fires originating from these apparatuses probably lead to flashover. In the case of dishwasher fires, the likelihood of flashover is considerable. The probability of flashover TV set fires in relatively large spaces (such as living rooms) depends mainly on the probability of ignition of other items in the room. In small rooms, e.g., children's bedrooms, the TV fires are considerably more dangerous than in larger rooms. In the case of washing machine fires, the development of the fire is in practice usually governed by the

availability of oxygen since the rooms with washing machines mainly have closed openings.

Smoke production was high especially for TV sets. Thus, smoke damages are likely to be considerable in fires involving electrical household appliances.

Preface

Electrical household appliances constitute an important origin of fires. This study was carried out to study their burning behaviour. The apparatuses studied were TV sets, washing machines, dishwashers and refrigerator-freezers. The selection of these apparatuses was based on the frequency of fires initiated by these apparatuses according to Finnish statistics.

The study was funded by the Safety Technology Authority (TUKES) (principal financier) and VTT Building Technology. It constitutes a contribution to the TUKES research project *Sähköpalon aiheuttajien palo-ominaisuudet* (Fire performance of initiators of electric fires) led by Veli-Pekka Nurmi from TUKES. We thank him, Veli-Matti Sääsilahti and Mikko Törmänen from TUKES for their invaluable contributions to the study. The guidance provided by the Steering Group of the TUKES project (Jari Pouta, Vantaa Rescue Services; Seppo Pekurinen, Federation of Finnish Insurance Companies; Timo Lojonen, Emergency Services College and Kai Sjöholm, National Bureau of Investigation) is gratefully acknowledged.

The authors are grateful to Mr. Konsta Taimisalo and Mr. Hemmo Juutilainen for their skilful assistance in the experiments.

Contents

Abstract.....	3
Preface.....	5
1. Introduction.....	8
2. Apparatuses studied.....	10
3. Experimental.....	14
3.1 Measurements and quantities derived from the data.....	14
3.2 Ignition method.....	15
3.3 Outline of the course of the experiments.....	17
4. Logbook entries and photographs.....	18
4.1 Logbook entries.....	18
4.1.1 TV sets.....	18
4.1.2 Washing machines.....	20
4.1.3 Dishwashers.....	23
4.1.4 Refrigerator-freezers.....	27
4.2 Photographs.....	31
4.2.1 TV sets.....	31
4.2.2 Washing machines.....	32
4.2.3 Dishwashers.....	33
4.2.4 Refrigerator-freezers.....	35
5. Results.....	37
5.1 Graphs showing temporal evolution.....	37
5.1.1 TV sets.....	37
5.1.2 Washing machines.....	39
5.1.3 Dishwashers.....	41
5.1.4 Refrigerator-freezers.....	43
5.2 Tabulation of characteristic values.....	45
5.3 Production of hydrogen halides.....	47
5.4 Summary of the results.....	48
6. Considerations of the fire safety aspects.....	52
6.1 Assessment of the development of a fire initiated by a burning electrical appliance	52
6.1.1 Flame contact and radiation.....	52
6.1.2 Build up of the hot upper layer and flashover.....	53

6.1.2.1	Smoke layer descent.....	54
6.1.2.2	Temperatures.....	55

APPENDICES

APPENDIX A: RESULTS OF A LITERATURE SURVEY

APPENDIX B: FTIR MEASUREMENTS

APPENDIX C: RESULTS OF THE PRELIMINARY TV EXPERIMENT

APPENDIX D: ON THE FIRE GROWTH RATE

APPENDIX E: HAZARD CALCULATIONS

1. Introduction

Electrical household appliances constitute an important origin of fires. The problem of fires originating from TV sets is widely known and it has also been subjected to studies focussing on the burning behaviour of TV sets (Ahonen et al. 1984, Babrauskas et al. 1988, Troitzsch 1999, Simonson et al. 2000) and on the statistics of the frequency of TV fire occurrence (Nurmi et al. 1999, De Poortere et al. 2000). However, the contribution of fires originating from ignition of other domestic electrical appliances than TV sets, is by no means negligible. For example, in a Finnish study (Nurmi et al. 1999) addressing fires with an electrical origin, it was found out that TV fires account for 12 % and washing machine or dishwasher fires for 10 % of all fires of electrical origin. Fires originating from refrigerator-freezers make up 3 % of fires with an electrical origin. While there is some information on the TV set fires, there is hardly any data available on the burning of the other above-mentioned electrical household appliances.

This study was carried out to examine the burning behaviour of electrical appliances used in households. The apparatuses included in the study were TV sets, washing machines, dishwashers and refrigerator-freezers. The selection was determined by the Finnish statistics on the frequency of fires initiated by electrical appliances. For example, computer products were excluded because they do not appear as an equally severe problem as the above mentioned apparatuses. The experiments considered only the burning of the apparatuses as single items to produce basic data for the assessment of the hazards of fires involving these apparatuses as the first item to ignite.

With the *quantified* basic data of the burning of the electrical household appliances produced in this study, the associated fire hazards and their reduction can be put on a rational basis by using the data as starting points for quantitative assessment schemes. Through use of several different scenarios in the assessment of the consequences of fires initiated in the apparatuses, a sufficiently complete and reliable picture of the problem can be formed. To give a brief outline of the analysis required to extract fire hazard information from the experimental data, we have augmented our experimental data with rough hazard analysis based on simple analytical models. More thorough hazard analysis with computer fire models can easily be performed on the basis of the data.

Before the experiments a survey was carried out on the information available in literature concerning burning of electrical household appliances. The survey was focussed on quantitative data on the ignition and fire development (especially the rate of heat release). The information search relied mainly on the FIREDOC database (Jason 1996) with keywords related to the specific electrical apparatuses studied in this work, i.e., television sets, refrigerators/freezers, washing machines and dishwashers. Also computer related data was looked for. The information obtained on the fire studies of TV sets and computers are described in detail in Appendix A.

The principal finding of the literature survey was that, with the exception of burning of TV sets, *quantitative* information on the development of burning of electrical household appliances is scarce. Especially no such data were found concerning refrigerators/freezers, washing machines and dishwashers. Some data was found on the burning of computer products.

2. Apparatuses studied

The study consists of the 14 fire experiments listed in Table 2.1. (3 TV sets, 3 washing machines, 4 dishwashers and 4 refrigerator-freezers). Some of the apparatuses were brand new and some of them had been in use before the study. The apparatuses were removed from use or sell due to some faults (e.g. appearance of the device, electrical faults, etc.). More detailed information about the apparatuses (dimensions, etc.) is given in Table 2.2.

In addition to the experiments presented in Table 2.1, a preliminary burning test was carried out using a rather old TV set (Luma LF51M34, abbreviation TV0). This apparatus was burned on a TV-table made of particleboard.

All TV sets and washing machines as well as dishwashers AP1 and AP2 and refrigerator-freezers KL1 and KL2 were burned free-standing on a non-combustible base. Dishwashers AP3 and AP4 and refrigerator-freezers KL3 and KL4 were burned so that they were placed in cupboards to simulate the common domestic mounting, see Fig. 2.1. The cupboards used with the dishwashers weighted about 23 kg and the cupboards for the refrigerator-freezers ca. 51–52 kg. The sidewalls of the cupboards were made of melamine-faced particleboard and their rear wall was made of mineral wool.

The apparatuses were not connected to the electrical mains during the experiments. The washing machines, dishwashers and refrigerator-freezers were empty.

Table 2.1. Apparatuses and experiments.

Apparatus	Abbreviation/Test id	Mode of burning
Television set 1 (28")	TV1	free burning
Television set 2 (25")	TV2	free burning
Television set 3 (28")	TV3	free burning
Wash machine 1	PK1 ^{*)}	free burning
Wash machine 2	PK2	free burning
Wash machine 3	PK3	free burning
Dishwasher 1	AP1	free burning
Dishwasher 2	AP2	free burning
Dishwasher 3	AP3	in a cupboard
Dishwasher 4	AP4	in a cupboard
Refrigerator-freezer 1	KL1	free burning
Refrigerator-freezer 2	KL2	free burning
Refrigerator-freezer 3	KL3	in a cupboard
Refrigerator-freezer 4	KL4	in a cupboard

*) The abbreviations come from the Finnish names of the apparatuses.

Table 2.2. Dimensions of the apparatuses and relevant details of construction.

Apparatus	Width (mm)	Height (mm)	Depth (mm)	Apparatus mass (kg)	Cupboard mass (kg)	Relevant construction details
TV1	760	570	420	31,83	-	Plastic case, 28 '' cathode-ray tube (CRT)
TV2	650	500	420	24,42	-	Plastic case, 25 '' CRT
TV3	750	540	470	30,53	-	Plastic case, 28 '' CRT
PK1	400	840	600	69,32	-	Housing, deck and bottom plate made of steel. Plastic washing basin, washing drum of steel.
PK2	400	840	600	69,91	-	Similar to PK1
PK3	400	850	590	63,29	-	Housing and deck made of steel except the rear wall upper part made of plastic, no bottom plate. Plastic washing basin, washing drum of steel.
AP1	450	810	580	35,58	-	Insulation made of green material resembling felt. No deck; side and rear walls as well as hatch and bottom plate made of steel. A piece missing at the lower right edge.
AP2	600	840	580	47,50	-	Insulation made of black material resembling bitumen. No deck; side and rear walls as well as hatch and bottom plate made of steel.
AP3	600	820	580	47,29	22,31	Dishwashers 2 and 3 are of the same type.
AP4	590	810	570	43,59	22,56	Side walls and hatch made of steel. No rear wall; a steel base also in the back. Plastic bottom plate; no deck.
KL1	590	1950	600	69,99	-	Side walls made of steel; all intermediate levels made of plastic. No metal plate between the motor and freezer. Steel plate below the motor, open space in front of it. Refrigerant R134a tetrafluoroethane CF_3CH_2F
KL2	590	1850	600	67,23	-	Side walls made of steel; refrigerator ceiling made of plastic, no metal plate. Metal plate between the refrigerator and freezer; it fell during the experiment. No metal plate between the motor and freezer. Steel plate of dimensions 160 mm \times 590 mm below the motor, open space in front of it. Refrigerant R600a isobutane C_4H_{10}
KL3	590	1850	600	63,89	52,05	Side walls made of steel; a steel plate (520 mm \times 590 mm) in the refrigerator ceiling. No metal plate between the refrigerator and freezer. Metal plate between the motor and freezer. Steel plate of dimensions 240 mm \times 590 mm below the motor, open space in front of it. Refrigerant R12 dichlorodifluoromethane CCl_2F_2
KL4	550	1880	600	70,56	51,35	Side walls made of steel; refrigerator ceiling made of plastic, no metal plate. No metal plate between the refrigerator and freezer. No metal plate between the motor and freezer. Steel plate of dimensions 245 mm \times 550 mm below the motor, open space in front of it. Refrigerant R134a tetrafluoroethane CF_3CH_2F

Dishwashers

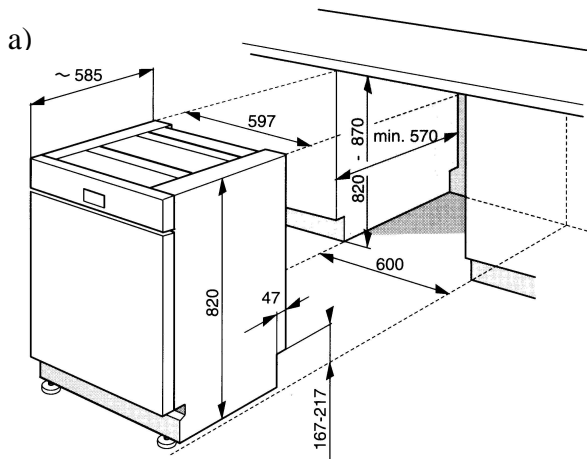

Refrigerator-freezers

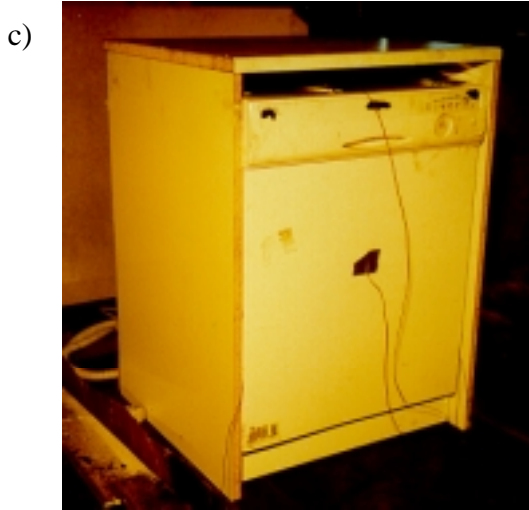
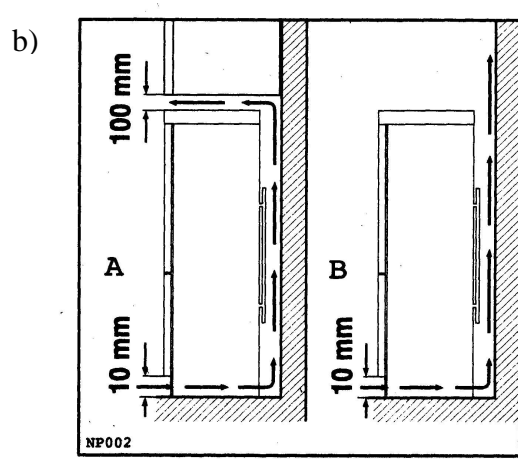

Figure 2.1. Installation of the dishwashers and refrigerator-freezers into the cupboards: a) & b) instructions provided by the manufacturers and c) & d) their implementation.

3. Experimental

The experiments were carried out in the large fire test facility of VTT Building Technology/Fire Research and Testing. The experimental arrangements are shown in Fig. 3.1. Measurements and calibrations were done following the standard method ISO 9705 (1993). A logbook was kept of the observations during the experiments. Each experiment was recorded on videotape and photographs. Excerpts of the logbook and photographs are presented in Chapter 4.

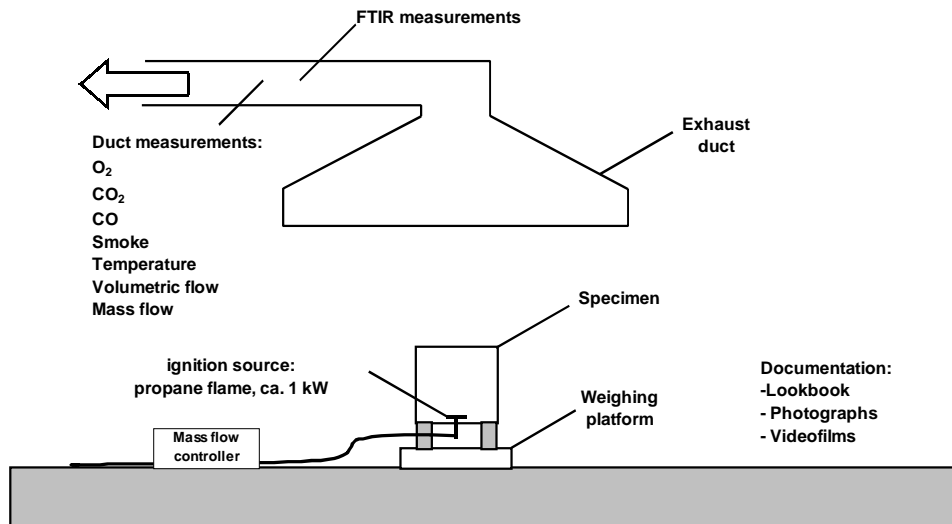

Figure 3.1. Experimental arrangements.

3.1 Measurements and quantities derived from the data

For all experiments, the measurements and quantities derived through data analysis are the following:

- Production of heat:
 - rate of heat release, RHR (kW),
 - effective heat of combustion, EHC (MJ/kg),
- Production of smoke expressed both in terms area and mass based figures:
 - rate of smoke production, RSP (m²/s), and mass rate of smoke production, MRSP (g/s),
 - specific extinction area, SEA (m²/kg), and mass conversion to smoke, Y_{smoke} (kg/kg).
- Production of carbon monoxide (CO) and carbon dioxide (CO₂):
 - rates of CO and CO₂ production, RCO and RCO₂ (g/s),
 - yields of CO and CO₂, Y_{CO} and Y_{CO₂} (kg/kg).

For experiments TV1, TV2, TV3, PK1, PK2, AP1, AP2 and KL1 the composition of the exhaust gases was measured using the FTIR technique. These measurements are described in Appendix B.

The effective heat of combustion was calculated from the RHR data and mass-loss rate MLR readings obtained from a weighing platform monitoring the mass of the system comprising the sample and the items used to hold the sample. The cumulated mass loss is denoted by ML.

The time histories of EHC shown in Chapter 5 are instantaneous values of the quotient RHR/MLR. This applies also to the other mass-based results (MRSP, Y_{CO} and Y_{CO_2}): they are ratios of the rate quantity to the MLR. The yields corresponding to the FTIR data are evaluated using the total mass loss during the interval that FTIR data were recorded.

The mass-based quantities characterising smoke production, MRSP and Y_{smoke} , are rough estimates obtained by dividing the corresponding area-based quantity by a factor σ_s (Östman 1992). For σ_s we use the value given by Choi et al. (1995), $\sigma_s = (8,0 \pm 1,1) \cdot 10^3 \text{ m}^2/\text{kg}$.

The RHR data were compared with the parabolic fire growth description (t^2 growth behaviour) to assess the growth rate parameter α used, e.g., in sprinkler activation time calculations.

3.2 Ignition method

The apparatuses were ignited with propane gas using a 100-mm long propane gas burner, the flame of which touched the position where it was aimed to set the fire on. The burner was operated at an output of 1 kW in all experiments except the experiment with the washing machine PK3 where power of 300–550 W was used. The power of 1 kW produces a flame of height 70–100 mm shown in Fig. 3.2.

Ignition by a flame was used as the purpose of the study was to investigate how burning of an electrical appliance proceeds after a small flame has emerged either because of a fault in the apparatus or via some other means. Investigations of different mechanisms causing flaming, such as short circuits or other heat-producing electrical failures and the potential associated with smouldering were not carried out.

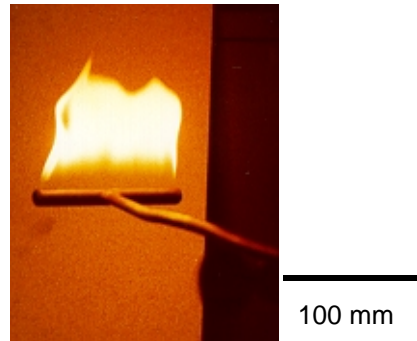

Figure 3.2. Ignition source.

The location of ignition was chosen to correspond to the origin of fires actually occurring in electrical appliances.

- In the TV set experiments, the burner was placed ca. 10 mm below the ventilation openings of the backplate so that the flame from the burner penetrated inside the apparatus.
- In the washing machine experiments, two ways of igniting were examined.
 - PK1 and PK2, the burner was placed below the plastic washing basin through a hole of dimensions of 20 mm × 110 mm cut to the back wall.
 - In the washing machine experiment PK3, the burner was inserted below a bundle of electrical wiring under the control panel through a hole of dimensions of 20 mm × 110 mm made to the plastic upper part of the rear wall. In this experiment, initially a lower ignitor output level of 300 W was employed. The burner extinguished after 35 s after which the ignition trial was continued by a gas torch, which ignited the plastic rear wall.
 - In the experiments with dishwashers, the burner was placed inside the motor space below plastic items located in the motor space. To enable such positioning, a hole of dimensions of either 40 mm × 15 mm (AP1) or 15–25 mm × 105–115 mm (AP2, AP3 and AP4) were cut to the rear wall. In the experiments AP3 and AP4, a hole with dimensions of 15 mm × 115 mm was made to the rear wall of the cupboard behind the apparatus.
- In the experiments with refrigerator-freezers, the burner was placed in the middle of the motor space at a distance of 10–20 mm below the separating surface between the motor space and the freezer. The distance of the burner from the rear wall was 100–140 mm. In the experiments KL3 and KL4, a hole with dimensions of 25 mm × 140 mm was made to the rear wall of the cupboard behind the apparatus.

3.3 Outline of the course of the experiments

In general, the experiments were done in following way. First, the collection of the exhaust duct data (also the FTIR, if used) and the sample mass measurement were started. Then, at 2 minutes, the heat exposure to the sample was initiated by placing the ignition source in the positions described above. This moment constitutes the zero time of the experiment: the time scales given in the following Chapters for the event logbook, photographs and results obtained from the measurements start from this moment. The video recording was started ca. 10 s before the positioning of the burner.

During the experiments, photographs were taken according to the progress of the burning so that especially the events during the development to the maximum burning became well documented by photographs. Some photographs were taken also during the decay phase of the burning as well as before and after the experiments. Logging of the data collected from the sensors monitoring the exhaust duct gases was stopped at the latest 1 hour after the start of the data logging. The weighing platform data was logged until the flames went out or were extinguished. The experiments with the refrigerator-freezers KL1, KL2 and KL4 had to be interrupted by extinguishing the apparatuses (and the cupboard) with a water hose because the fire grew so large that letting it continue could have induced damage to the experimental system. The experiment KL3 was stopped because one of the sidewalls of the cupboard broke down. More details of the events are given in next Chapter.

4. Logbook entries and photographs

4.1 Logbook entries

4.1.1 TV sets

Observations made during the experiments with the TV sets are shown in Tables 4.1, 4.2 and 4.3.

Table 4.1. Television set 1, observations during the experiment.

Time (h:min:s)	Observation
0:0:0	Burner is placed under the backplate ventilation openings, output 1 kW
0:0:50	Flaming melted plastics dripping above the burner
0:1:15	Burner is drawn away
0:2:00	Pool fire under the backplate
0:2:10	Backplate engulfed by flames
0:2:20	CRT breaks down by an implosion (Fig. 4.1c)
0:3:30	Only the parts of the case adjacent to the CRT edges are not burning
0:3:53	Front of the apparatus falls backwards to a horizontal position (Fig. 4.1d)
0:10:25	Pool fire
0:13:00	Burning decreases
1:06:11	Burning ends
After the test	All combustible materials consumed by the fire

Table 4.2. Television set 2, observations during the experiment.

Time (min:s)	Observation
0:0	Burner is placed under the backplate ventilation openings, output 1 kW
0:45	Flaming melted plastics drips above the burner
1:05	Burner is drawn away
1:25	Backplate engulfed by flames
2:00	Internal space of the casing engulfed by flames
2:40	The whole top of the TV is burning
2:55	CRT breaks down by an implosion and the front of the apparatus falls forward to a horizontal position
7:00	Large pool fire
12:30	Burning decreases
57:05	Burning ends
After the test	All combustible materials consumed by the fire

Table 4.3. Television set 3, observations during the experiment.

Time (min:s)	Observation
0:0	Burner is placed under the backplate ventilation openings, output 1 kW
0:55	Backplate in flames (Fig 4.1i)
1:30	Pool fire under the backplate
2:05	Flow of propane to the burner turned off
2:20	Burner is drawn away
3:20	Pool fire under the whole apparatus
3:35	Flames through the top of the case
3:45	Internal space of the casing engulfed by flames
3:55	CRT breaks down by an implosion
4:10	Only the surroundings of the CRT remain unburned
5:05	Front of the apparatus falls forward to a horizontal position
6:20	Large pool fire, width ca. 1 m
18:10	Large pool fire
54:30	Burning ends
After the test	All combustible materials consumed by the fire

4.1.2 Washing machines

Observations made during the experiments with the washing machines are shown in Tables 4.4, 4.5 and 4.6.

Table 4.4. Washing machine 1, observations during the experiment.

Time (h:min:s)	Observation
0:0:00	Burner is placed in the motor space under the washing basin, output 1 kW
0:2:15	Flaming droplets falling on the bottom of the motor space
0:2:50	Strips of melted plastic dripping on the bottom of the motor space
0:6:40	Burner covered by melted plastic; probably extinguished
0:6:50	Flow of propane to the burner turned off
0:8:20	Burning on the bottom of the motor space
0:13:00	Smoke emanating below the front edge of the lid and from back
0:15:00	Paint on the left-hand side wall turning brown
0:16:05	Flames emerging from the hole of the upper rim on the left-hand side
0:18:15	Flames coming out from the gap between the control panel and the housing
0:18:40	Continuous flames from the control panel (Fig. 4.2c)
0:19:10	Failure of the lid fixing, lid falling into the flames that engulf the whole apparatus
0:23:00	Intensive burning (Fig. 4.2d)
0:28:35	Burning starts to diminish
0:48:30	Flames only occasionally over the upper rim of the apparatus
1:59:45	Burning ends
After the test	All combustible materials consumed by the fire. A pool fire was not formed outside the apparatus because of its closed structure. The water hoses and electric leads burned outside the apparatus.

Table 4.5. Washing machine 2, observations during the experiment.

Time (h:min:s)	Observation
<i>1. trial</i>	
0:0:00	Burner is placed in the motor space under the washing basin, output 1 kW
2:15	Melted plastic dripping on the burner
3:05	Burner went out
5:10	No burning in the motor space
<i>2. trial</i>	
0:0:00	Burner is placed in the motor space under the washing basin
0:0:25	Melted plastic dripping from the bottom of the washing basin
0:3:40	Plastic ignites
0:4:15	Burner drawn away
0:5:25	Plastic burning on the bottom plate
0:10:00	Burning increases in the motor space
0:15:00	Increase in smoke production
0:18:15	Flames from the front edge of the control panel
0:19:00	Half of the control panel in flames
0:20:00	The whole control panel in flames
0:21:25	Flames also in the front and on the left
0:23.40	Continuous flaming in the front (Fig. 4.2h)
0:27:00	Whole apparatus in flames
0:33:00	Burning starts to diminish
1:55:35	Burning ends
After the test	All combustible materials consumed by the fire. The lid remained on the apparatus throughout the experiment. A pool fire was not formed outside the apparatus because of its closed structure. The water hoses and electric leads burned outside the apparatus.

Table 4.6. Washing machine 3, observations during the experiment.

Time (h:min:s)	Observation
0:0:00	Burner is placed under the control panel, output 300 W (Fig. 4.2a)
0:0:35	Burner went out
0:1:15	Re-ignition of the burner by a gas torch
0:1:50	Burner output 550 W
0:2:25	Flow of propane to the burner turned off
0:2:55	Ignition of the hole made for the burner on the plastic upper part of the rear wall by the torch (Fig. 4.2j)
0:6:25	Half of the control panel in flames
0:7:55	Burning trickles from the control panel dripping down the rear wall
0:10:45	Plastic bottom below the control panel burned off
0:11:25	Burning increases (Fig. 4.2k)
0:18:45	Flames emanating below the front of the lid
0:25:25	Lid falls down the into the apparatus
0:31:15	Pool fire in front of the apparatus and on its left-hand side (Fig. 4.2l)
0:45:30	Pool fire decays
1:08:0	Flames occasionally above the upper rim
1:36:0	Burning ends
After the test	All combustible materials consumed by the fire.

4.1.3 Dishwashers

Observations made during the experiments with the dishwashers are shown in Tables 4.7, 4.8, 4.9 and 4.10.

Table 4.7. Dishwasher 1, observations during the experiment.

Time (h:min:s)	Observation
Before the experiment	The hatch is about 10 cm ajar. A 3-cm gap in the rear left corner of the bottom plate. A piece missing from the right-hand side lower corner of the control panel.
0:0:0	Burner is placed under the washing basin in the motor space, output 1 kW
0:1:45	Smoke from back
0:2:25	Glow of flames reflecting from the bottom plate
0:2:55	Smoke from front
0:3:35	Burning increases in the motor space
0:4:20	Flames out of the gap of the hatch (Fig. 4.3a)
0:5:15	Insulation on the washing basin generates smoke
0:5:35	Insulation on the washing basin ignites
0:5:45	Control panel in flames
0:7:55	Pool fire in front of the apparatus
0:8:07	Hatch opens 90 degrees
0:8:45	Insulation in the back catches fire
0:12:00	Burning starts to diminish
0:17:00	Motor space engulfed in flames
0:18:30	Flames from a gap located on the left in the back
0:22:00	Burning in the motor space starts to diminish
1:27:00	Smouldering fire on the bottom plate
After the test	All combustible materials consumed by the fire.

Table 4.8. Dishwasher 2, observations during the experiment.

Time (h:min:s)	Observation
Before the experiment	Hatch is closed
0:0:0	Burner is placed under the washing basin in the motor space, output 1 kW
0:1:40	Flames in the motor space
0:2:25	Burner drawn away
0:4:25	Motor space engulfed in flames
0:4:40	Flames on the washing basin
0:9:25	Burning on the washing basin and outside the apparatus on the plate supporting the apparatus on the weighing platform
0:16:00	Surface of the control panel in flames
0:18:25	Control panel melts and falls off
0:19:00	Front of the apparatus covered with flames (Fig. 4.3h)
0:20:00	Pool of burning plastic in front of the apparatus
0:21:00	Burning has diminished
2:20:00	Burning ends
After the test	All combustible materials consumed by the fire. The hatch did not open during the fire.

Table 4.9. Dishwasher 3, observations during the experiment.

Time (min:s)	Observation
Before the experiment	Hatch is closed
0:00	Burner is placed under the washing basin in the motor space, output 1 kW
1:15	Smoke from the front
3:30	Burner drawn away
4:30	Motor space engulfed in flames
5:05	Snapping sounds from the burning particle board
5:25	Flames out of the open space between the apparatus and the particle board plane above it
6:00	Smoke, no flames visible (Fig. 4.3j)
6:28	Flame from the front below the particle board plane
6:45	Smoke becomes darker
7:50	Continuous flames from the front below the particle board plane
11:00	Upper edge of the control panel burns
13:00	Burning plastic in front of the apparatus (Fig. 4.3l)
15:00	Particleboard wall on the left burns after catching fire from the burning plastic pool
17:40	Ignition of the front edge of the particle board plane
22:24	Mineral wool rear wall of the cupboard falls partially outside the weighing system
26:00	Burning diminished
29:40	Left particle board wall falls outside the weighing system
33:40	Right particle board wall falls outside the weighing system
38:30	Extinguishing with water
After the test	The apparatus completely destroyed. The hatch did not open during the fire.

Table 4.10. Dishwasher 4, observations during the experiment.

Time (min:s)	Observation
Before the experiment	Hatch is closed
0:00	Burner is placed under the washing basin in the motor space, output 1 kW
2:35	Burner drawn away, burning in the motor space
6:00	Smoke from the front (Fig. 4.3n)
7:00	Increased smoke flow from the front
8:14	Hatch opens to an angle of 45 degrees (Fig. 4.3o)
8:30	Hatch opens to an angle 90 degrees
8:40	Flames out from below particle board plane
9:35	Lower dish basket ignites
11:30	Whole washing space in flames
12:30	Flames from back
24:00	Pool of non-ignited melted plastic in front of the hatch
25:30	Particle boards burning, flames in the motor space
35:20	Pool of melted plastic in front of the apparatus ignites
44:39	Left particle board wall falls outside the weighing system
45:30	Extinguishing with water
After the test	The apparatus completely destroyed.

4.1.4 Refrigerator-freezers

Observations made during the experiments with the refrigerator-freezers are shown in Tables 4.11, 4.12, 4.13 and 4.14.

Table 4.11. Refrigerator-freezer 1, observations during the experiment.

Time (min:s)	Observation
0:00	Burner is placed under the plastic surface of the plane between the motor space and the freezer, output 1 kW
0:45	Flaming droplets from the plane between the motor space and the freezer
0:55	Cardboard on the rear wall ignited (Fig. 4.4a)
2:00	Flames of height 1 m on the rear wall
2:15	Flames reach the upper edge of the apparatus
5:00	Flow of propane to the burner turned off
6:00	Rear wall covered with flames (Fig. 4.4b)
7:35	Refrigerant bursts out, blast flame
8:30	Freezer door opens ca. 10 cm
8:55	Flash of flames from the freezer
9:10	Black smoke from the freezer
11:00	Flames from the freezer (Fig. 4.4c)
12:00	Sealings of the refrigerator door start to burn
13:35	Refrigerator door slightly open
15:10	Freezer door falls off
15:17	Refrigerator door falls off
15:25	Extinguishing with water
After the test	The plastic ceiling, rear wall, plane between the refrigerator and freezer, inner housing and insulating materials vanished. Reminders lie on the bottom of the apparatus. Solderings of the freezing system melted at least at two positions.

Table 4.12. Refrigerator-freezer 2, observations during the experiment.

Time (min:s)	Observation
0:00	Burner is placed under the plastic surface of the plane between the motor space and the freezer, output 1 kW
0:35	Flaming droplets from the plane between the motor space and the freezer
0:45	Cardboard on the rear wall ignited
1:30	Flames of height 1,2 m on the rear wall
2:05	Flow of propane to the burner turned off
2:10	Flames reach the upper edge of the apparatus
2:45	Rear wall covered with flames, burning material flows outside the apparatus
3:30	Half of the ceiling in fire
4:20	Whole ceiling in fire
5:55	Flames coming from under the apparatus in the front
7:15	Some of the sealings of the refrigerator door burn
7:45	Black smoke
9:45	Refrigerator door opens 5 cm
10:15	Refrigerator engulfed in flames
11:10	Freezer door opens to an angle of 90 degrees
11:20	Freezer engulfed in flames (Fig. 4.4g)
12:02	Extinguishing with water
After the test	The plastic ceiling, rear wall, plane between the refrigerator and freezer, inner housing and insulating materials vanished. Reminders lie on the bottom of the apparatus. Sealing of the refrigerator door hanging half burned stuck to the plate supporting the sidewalls (Fig. 4.4h). No observations were made of gas leakages or ignition of the refrigerant. No broken pipeline connections were found after the experiment. After a pipeline coming from the compressor was cut, the gas coming out smelled like liquefied petroleum gas. It ignited from a gas torch flame.

Table 4.13. Refrigerator-freezer 3, observations during the experiment.

Time (h:min:s)	Observation
0:0:00	Burner is placed under the plastic surface of the plane between the motor space and the freezer, output 1 kW
2:30	Burner drawn away
3:50	Flames from the gap between the apparatus and the cupboard construction (Fig. 4.4j)
5:00	Control panel in top of the apparatus melts
5:20	Right wall of the cupboard burns
5:45	Gap in the mineral wool wall of the cupboard up to the height of the refrigerator
7:15	Refrigerator door falls outside the weighing system (Fig. 4.4k)
8:00	Half of the refrigerator burns
9:50	Whole refrigerator burns
12:45	Right wall of the cupboard falls off
15:30	Plane between the refrigerator and the freezer has burned through, flames in the freezer
16:30	Freezer door slightly open
18:20	Freezer door moves
18:27	Freezer door opens to an angle of 90 degrees and falls of (Fig. 4.4l)
21:15	Ceiling of the cupboard falls down
22:45	Upper part of the left sidewall of the cupboard falls outside the weighing system
24:45–25:40	Right sidewall of the cupboard falls beyond the weighing system
23:45	Extinguishing with water
After the test	The rear wall, plane between the refrigerator and freezer, inner housing and insulating materials vanished. Reminders lie on the bottom of the apparatus. The steel plate in the apparatus ceiling partially bended inwards. Solderings of the back of the apparatus melted, solderings in the motor space almost intact. No observations of ignition of the refrigerant.

Table 4.14. Refrigerator-freezer 4, observations during the experiment.

Time (h:min:s)	Observation
0:0:00	Burner is placed under the plastic surface of the plane between the motor space and the freezer, output 1 kW
1:30	Black smoke
2:10	Burner drawn away
3:30	Gap of ca. 0,5 m in the mineral wool rear wall of the cupboard at the height of the freezer
4:00	Flames of height of ca. 1 m in the back (Fig. 4.4n)
4:35	Flames coming from below the freezer in the front
4:50	Flames from the right-hand side edge of the freezer door
6:40	Gap in the wool rear wall of the cupboard increases
7:00	Freezer door slightly open
7:41	Refrigerant bursts out, blast flame in the back
8:35	Gap in the mineral wool rear wall of the cupboard at the height of the refrigerator
9:20	Freezer door falls off of its hinges, remains in an upright position covering the freezer doorway partially
9:40	Freezer engulfed in flames
10:20	Whole front side of the apparatus in flames
10:42	Refrigerator door opens 2–3 cm
12:20	Pool fire in front of the apparatus (Fig. 4.4p)
13:00	Refrigerator door opens to an angle of 20–30 degrees
13:20	Refrigerator door opens more
13:25	Refrigerator door falls off
13:40	Extinguishing with water
After the test	<p>Losses of the insulating materials (rough estimates):</p> <ul style="list-style-type: none"> • Refrigerator: rear wall ca. 50 % lost; sidewall insulators charred on the surface; floor ca. 15 % lost; door 100 % losses • Freezer: rear wall lost completely; right sidewall 50 % and left sidewall 70 % losses; ceiling ca. 30 % lost; floor 100 % losses; door 70 % <p>Solderings in the motor space melted.</p>

4.2 Photographs

4.2.1 TV sets

Photographs taken during the TV set experiments are shown in Fig. 4.1.

TV 1

a) 00:40



b) 01:35



c) 02:20



d) 03:53



TV 2

e) 00:15



f) 01:35



g) 02:25



h) 03:00



TV 3

i) 00:55



j) 02:50



k) 04:45



l) 05:25



Figure 4.1. Photographs of the TV set experiments.

4.2.2 Washing machines

Photographs taken during the washing machine experiments are shown in Fig. 4.2.

PK 1

a) 07:50



b) 18:25



c) 18:55



d) 22:50



PK 2

e) Before the experiment



f) 17:55



g) 19:25



h) 23:55



PK 3

i) Control panel before the experiment



j) 02:55



k) 11:55



l) 31:45



Figure 4.2. Photographs of the washing machine experiments.

4.2.3 Dishwashers

Photographs taken during the dishwasher experiments are shown in Fig. 4.3.

AP 1

a) 04:55



b) 06:25



c) 10:00

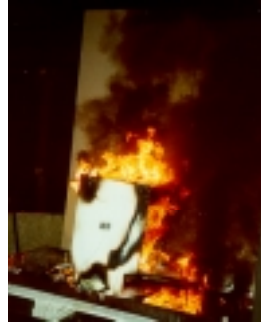

d) 28:00



AP 2

e) Washing space
before the experiment

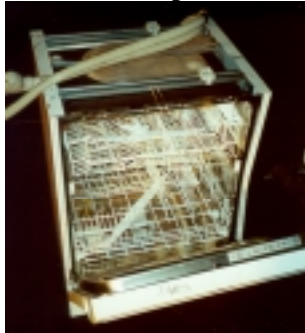

f) 06:00



g) 10:00



h) 19:00



Figure 4.3. Photographs of the dishwasher experiments (cont'd on the next page).

AP 3 (in a cupboard)

i) Before the experiment



j) 06:00



k) 09:30



l) 13:00



AP 4 (in a cupboard)

m) Motor space before the experiment

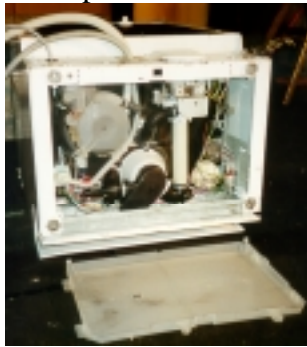

n) 06:00



o) 08:20



p) 10:10



Figure 4.3. Photographs of the dishwasher experiments (cont'd).

4.2.4 Refrigerator-freezers

Photographs taken during the refrigerator-freezer experiments are shown in Fig. 4.4.

KL 1

a) 01:25

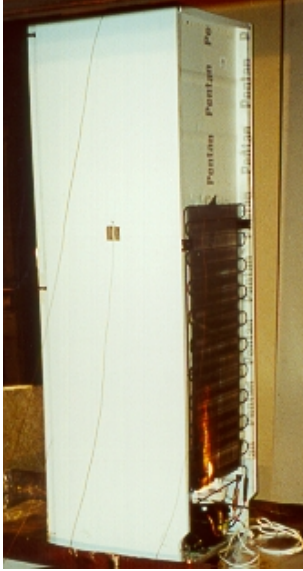

b) 05:55



c) 11:10



d) 13:05



KL 2

e) 01:25



f) 05:35



g) 11:20



h) After the experiment



Figure 4.4. Photographs of the refrigerator-freezer experiments (cont'd on the next page).

KL 3 (in a cupboard)

i) Before the experiment



j) 04:00

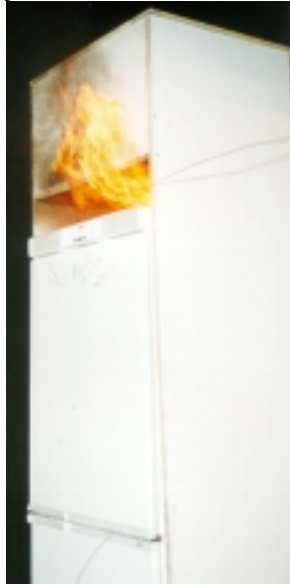

k) 07:30



l) 18:50



KL 4 (in a cupboard)

m) Before the experiment



n) 04:00



o) 06:00



p) 12:30



Figure 4.4. Photographs of the refrigerator-freezer experiments (cont'd).

5. Results

5.1 Graphs showing temporal evolution

5.1.1 TV sets

Graphs of RHR, ML and EHC for the TV set experiments are shown in Fig. 5.1 (graphs for the preliminary experiment with TV0 are shown in Appendix C). The graphs of smoke production are shown in Fig. 5.2 and the graphs of CO and CO₂ production in Fig. 5.3.

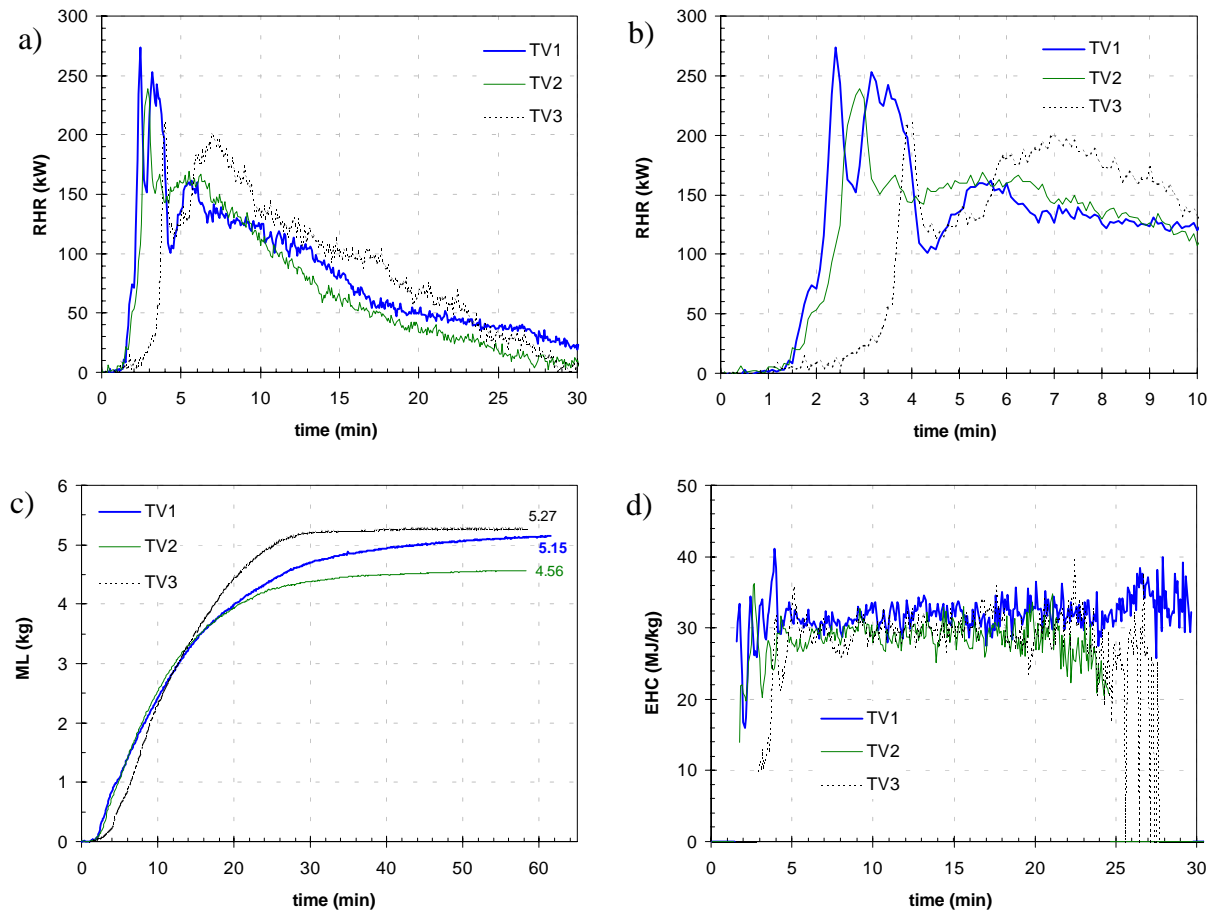

Figure 5.1. TV sets: a) RHR (time 0–30 min), b) RHR (time 0–10 min), c) ML and d) EHC. The numbers associated with the graphs showing the mass loss denote the mass loss at the end of the experiment.

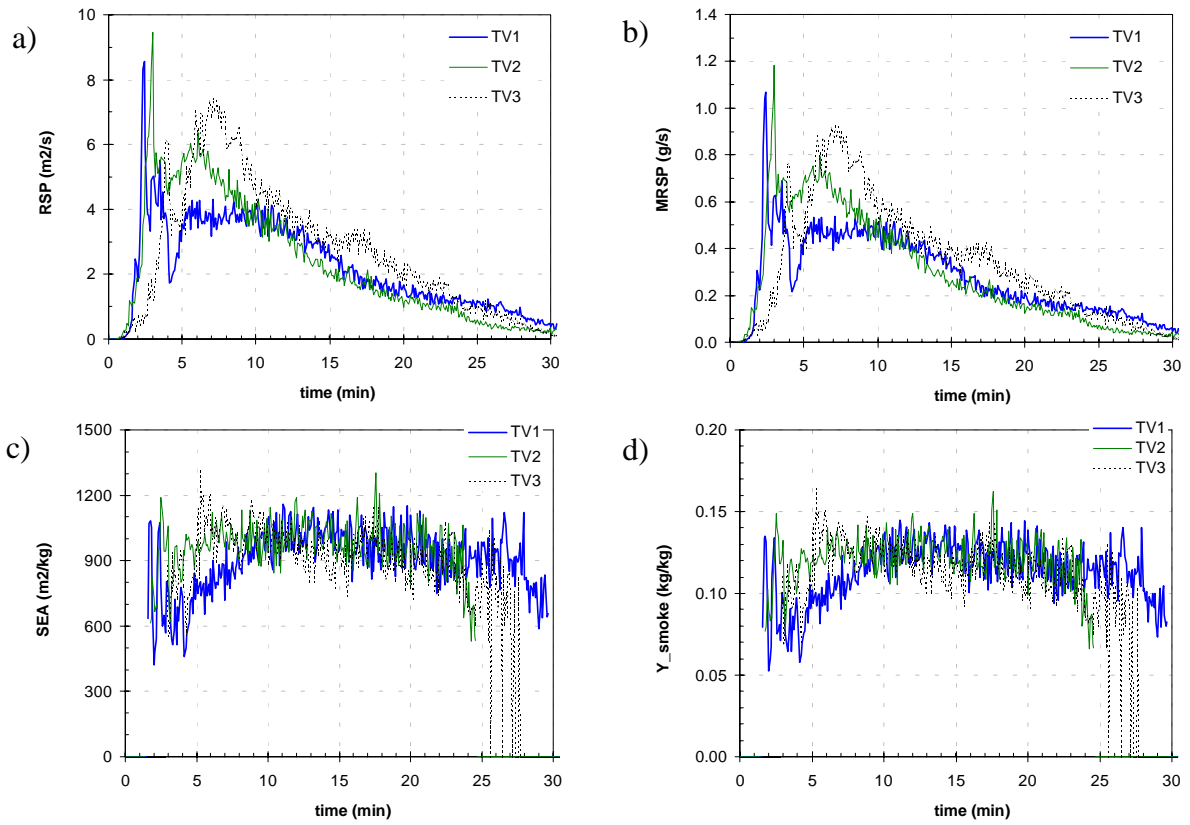

Figure 5.2. TV sets, smoke production: a) RSP, b) MRSP, c) SEA and d) Y_{smoke} .

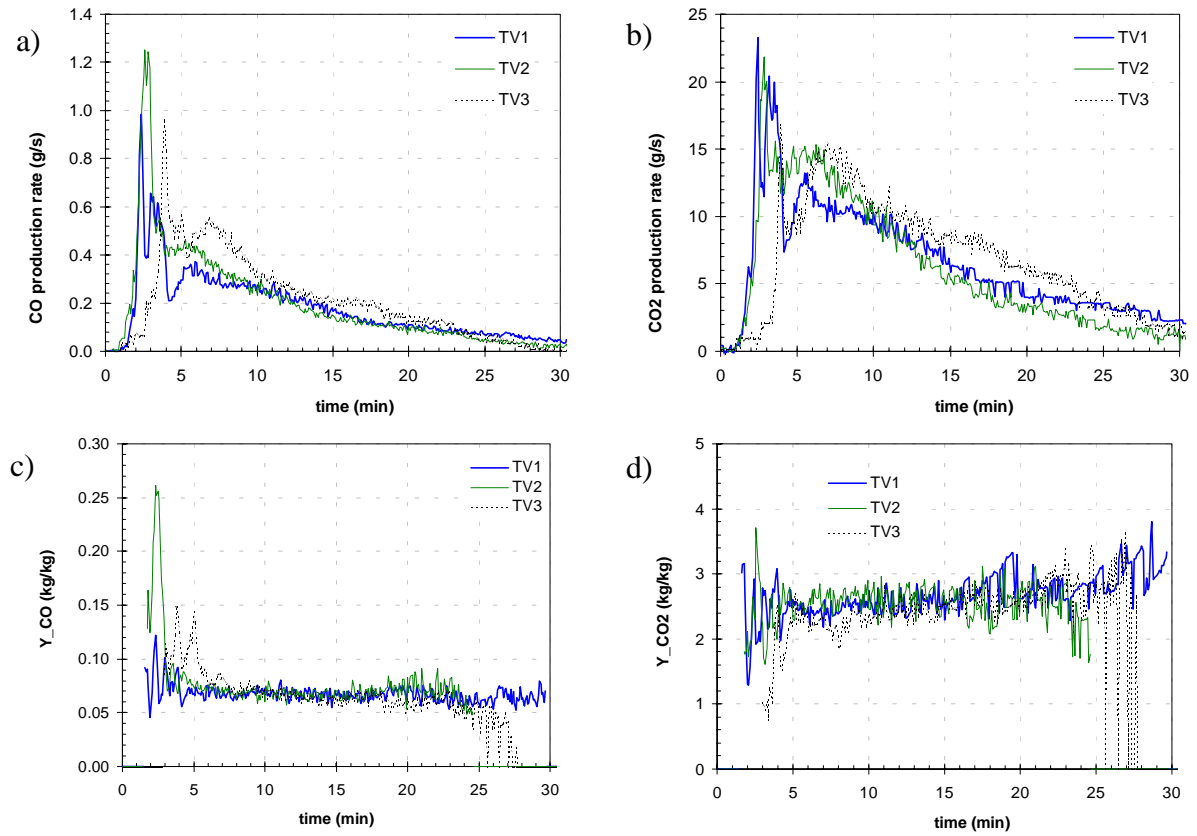

Figure 5.3. TV sets, CO and CO₂ production: a) RCO, b) RCO₂, c) Y_{CO} and d) Y_{CO_2} .

5.1.2 Washing machines

Graphs of RHR, ML and EHC for the washing machine experiments are shown in Fig. 5.4. The graphs of smoke production are shown in Fig. 5.5 and the graphs of CO and CO₂ production in Fig. 5.6.

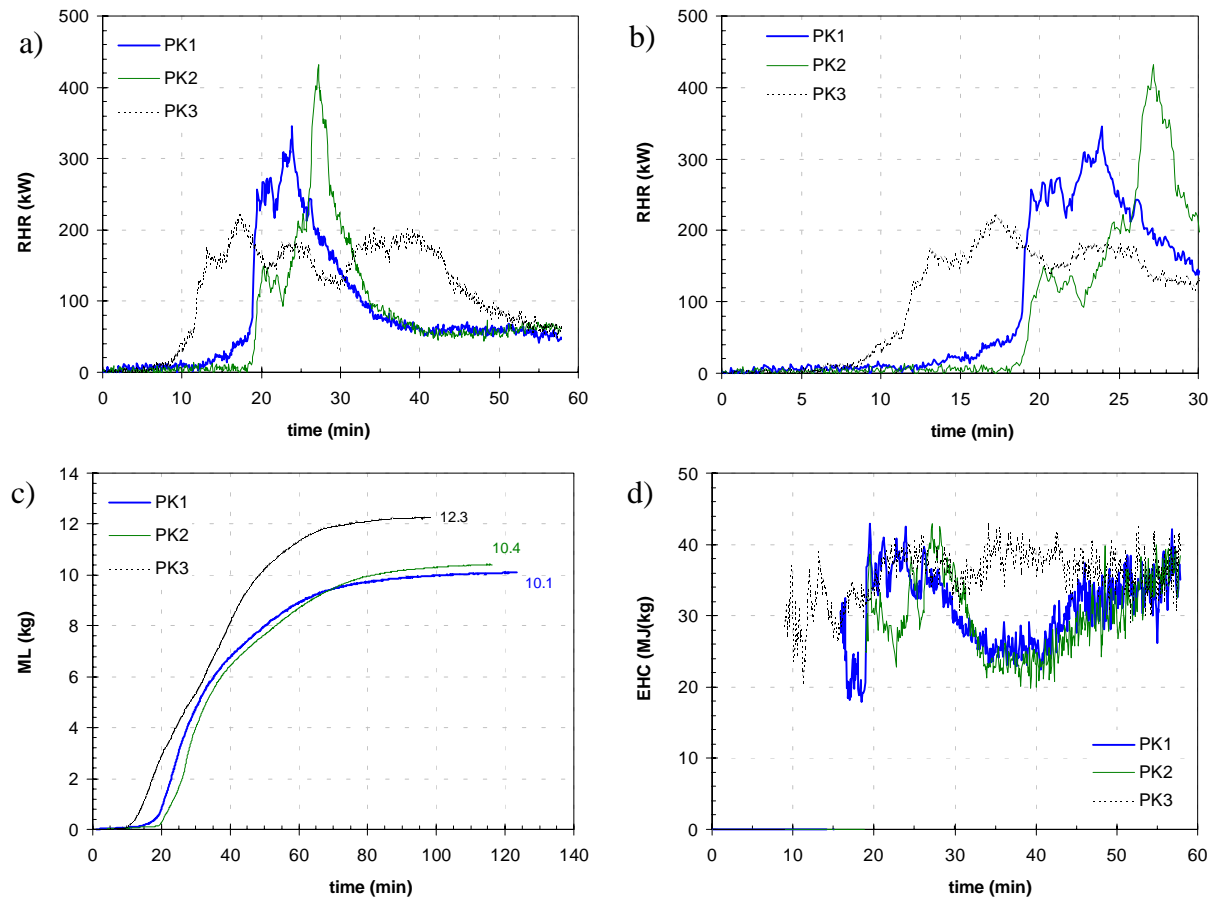

Figure 5.4. Washing machines: a) RHR (time 0–60 min), b) RHR (time 0–30 min), c) ML and d) EHC. The numbers associated with the graphs showing the mass loss denote the mass loss at the end of the experiment.

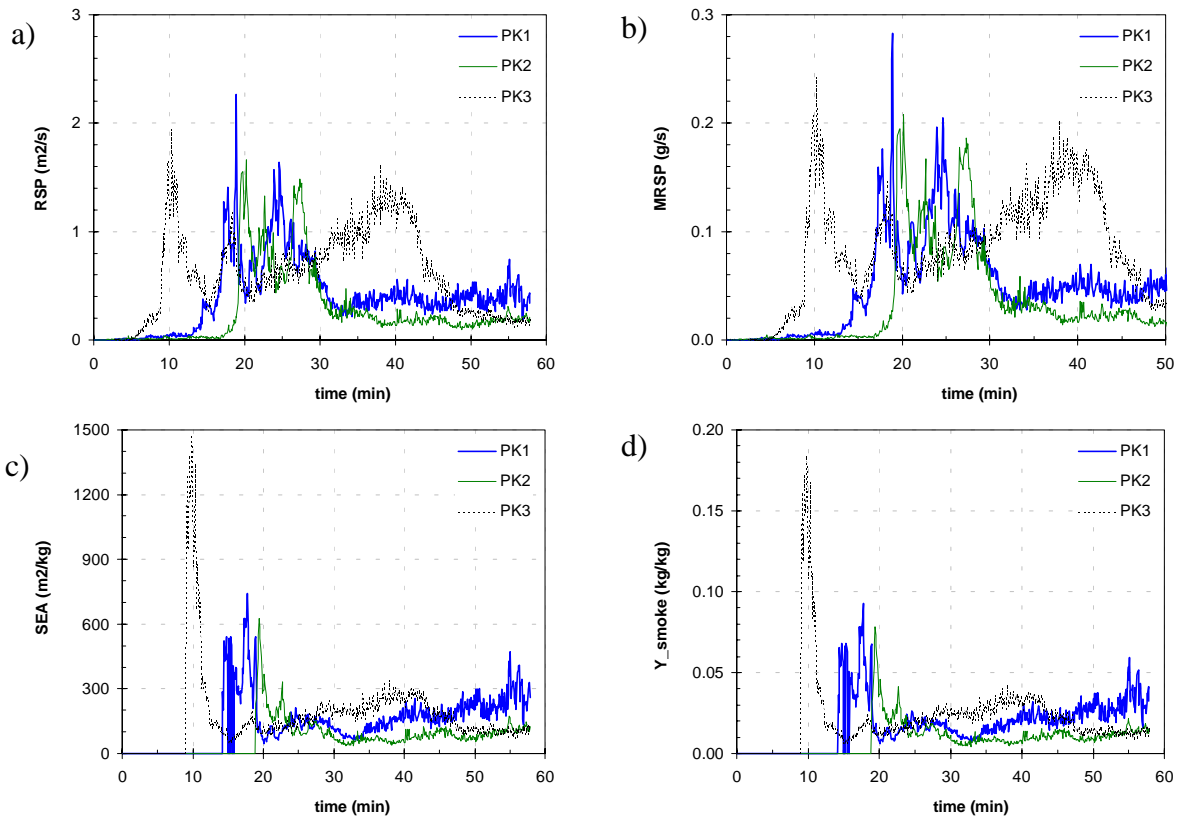

Figure 5.5. Washing machines, smoke production: a) RSP, b) MRSP, c) SEA and d) Y_{smoke} .

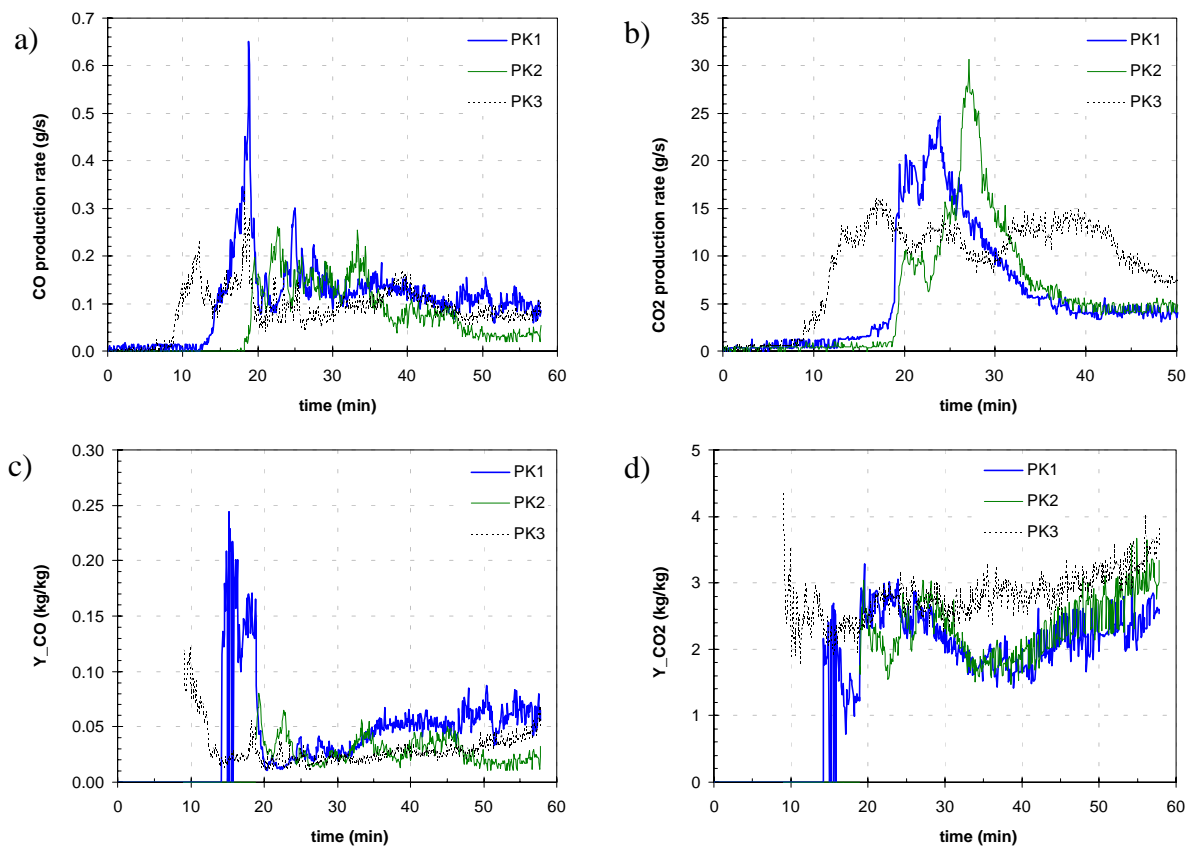

Figure 5.6. Washing machines, CO and CO₂ production: a) RCO, b) RCO₂, c) Y_{CO} and d) Y_{CO_2} .

5.1.3 Dishwashers

Graphs of RHR, ML and EHC for the dishwasher experiments are shown in Fig. 5.7. The graphs of smoke production are shown in Fig. 5.8 and the graphs of CO and CO₂ production in Fig. 5.9.

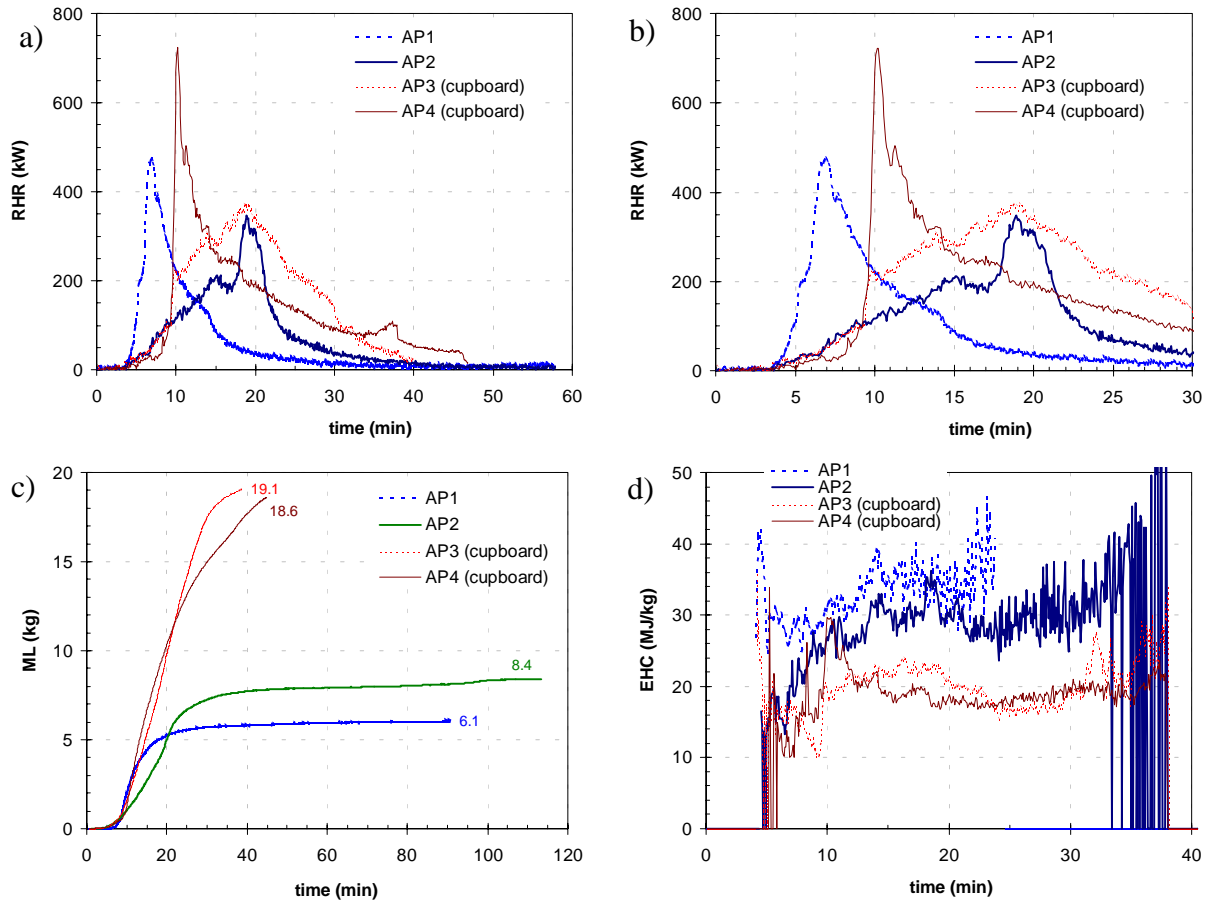

Figure 5.7. Dishwashers: a) RHR (time 0–60 min), b) RHR (time 0–30 min), c) ML and d) EHC. The numbers associated with the graphs showing the mass loss denote the mass loss at the end of the experiment.

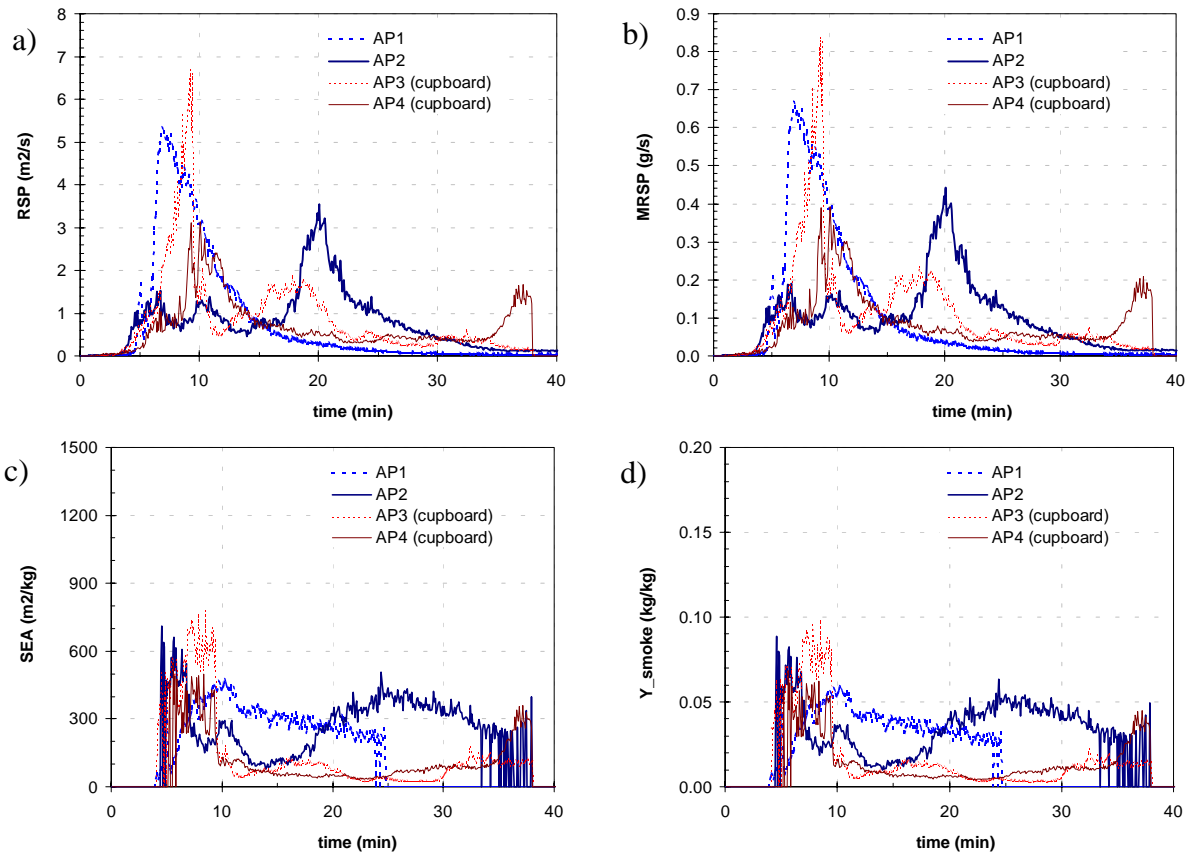

Figure 5.8. Dishwashers, smoke production: a) RSP, b) MRSP, c) SEA and d) Y_{smoke} .

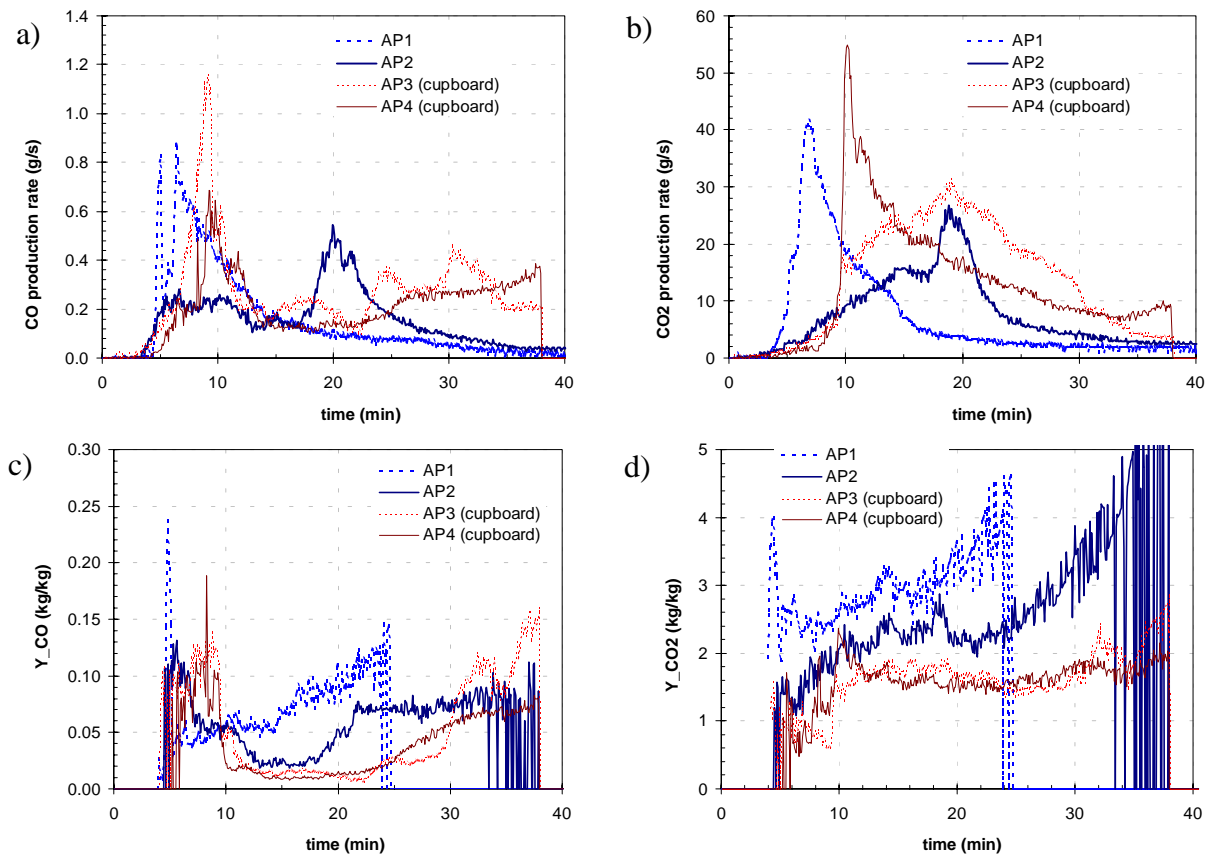

Figure 5.9. Dishwashers, CO and CO₂ production: a) RCO, b) RCO₂, c) Y_{CO} and d) Y_{CO_2} .

5.1.4 Refrigerator-freezers

Graphs of RHR, ML and EHC for the washing machine experiments are shown in Fig. 5.10. The graphs of smoke production are shown in Fig. 5.11 and the graphs of CO and CO₂ production in Fig. 5.12.

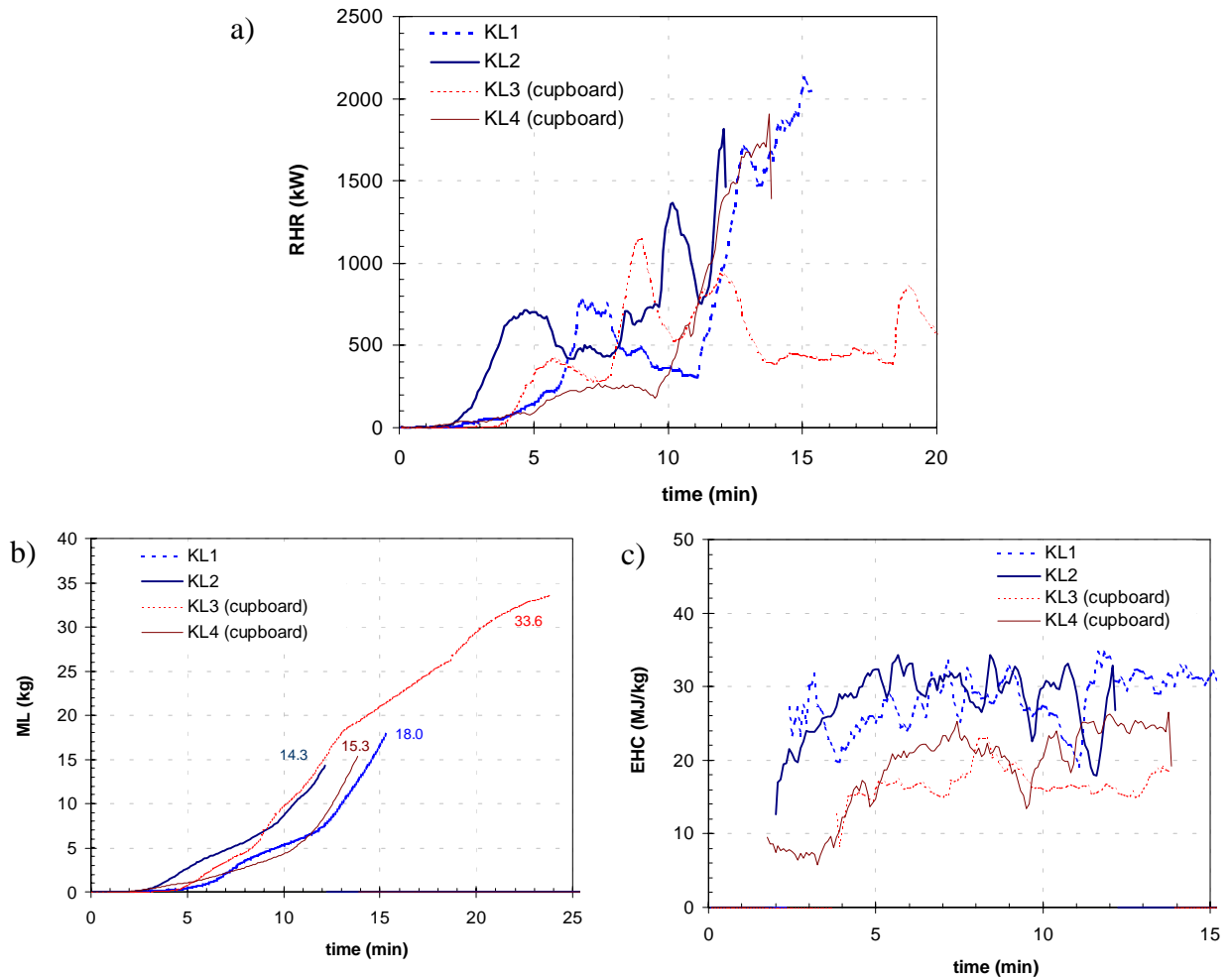

Figure 5.10. Refrigerator-freezers: a) RHR, b) ML and c) EHC. The experiments were interrupted by extinction with water. The numbers associated with the graphs showing the mass loss denote the mass loss at the end of the experiment.

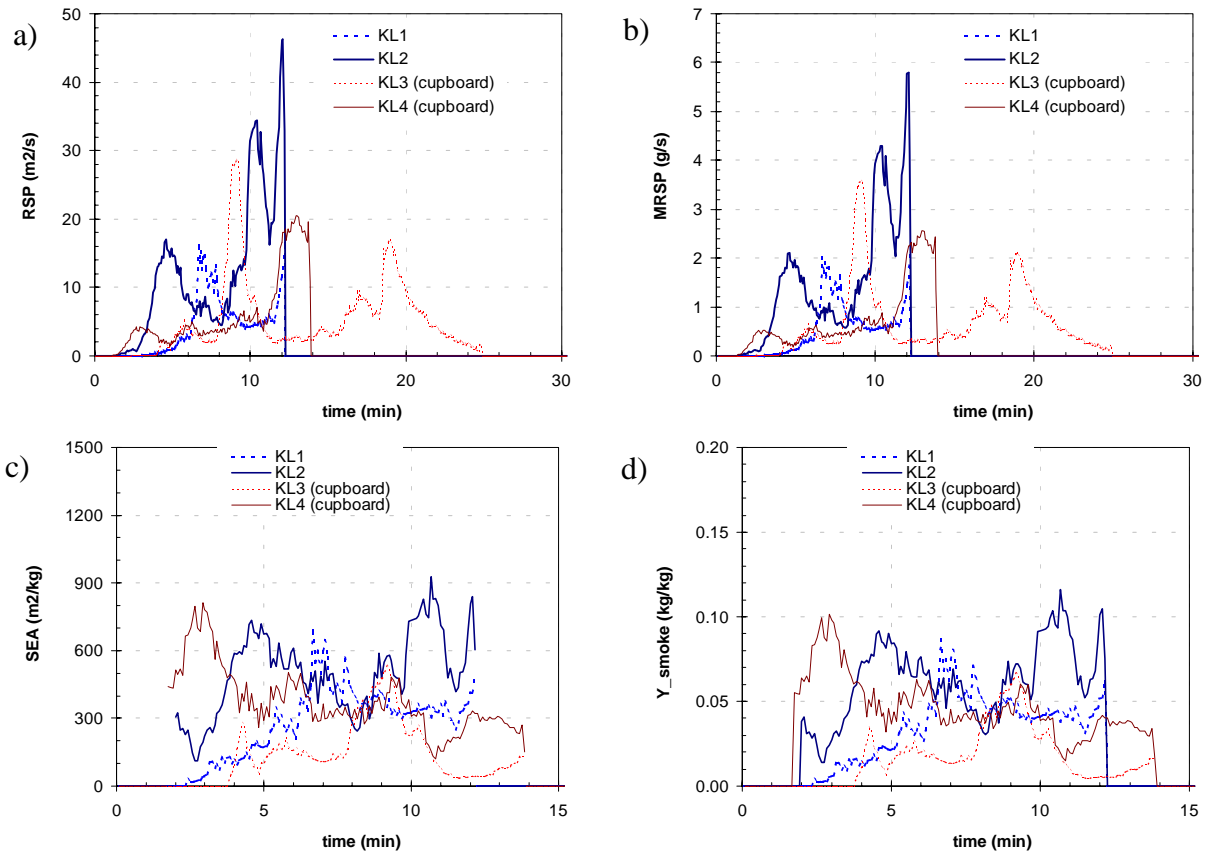

Figure 5.11. Refrigerator-freezers, smoke production: a) RSP, b) MRSP, c) SEA and d) Y_{smoke} .

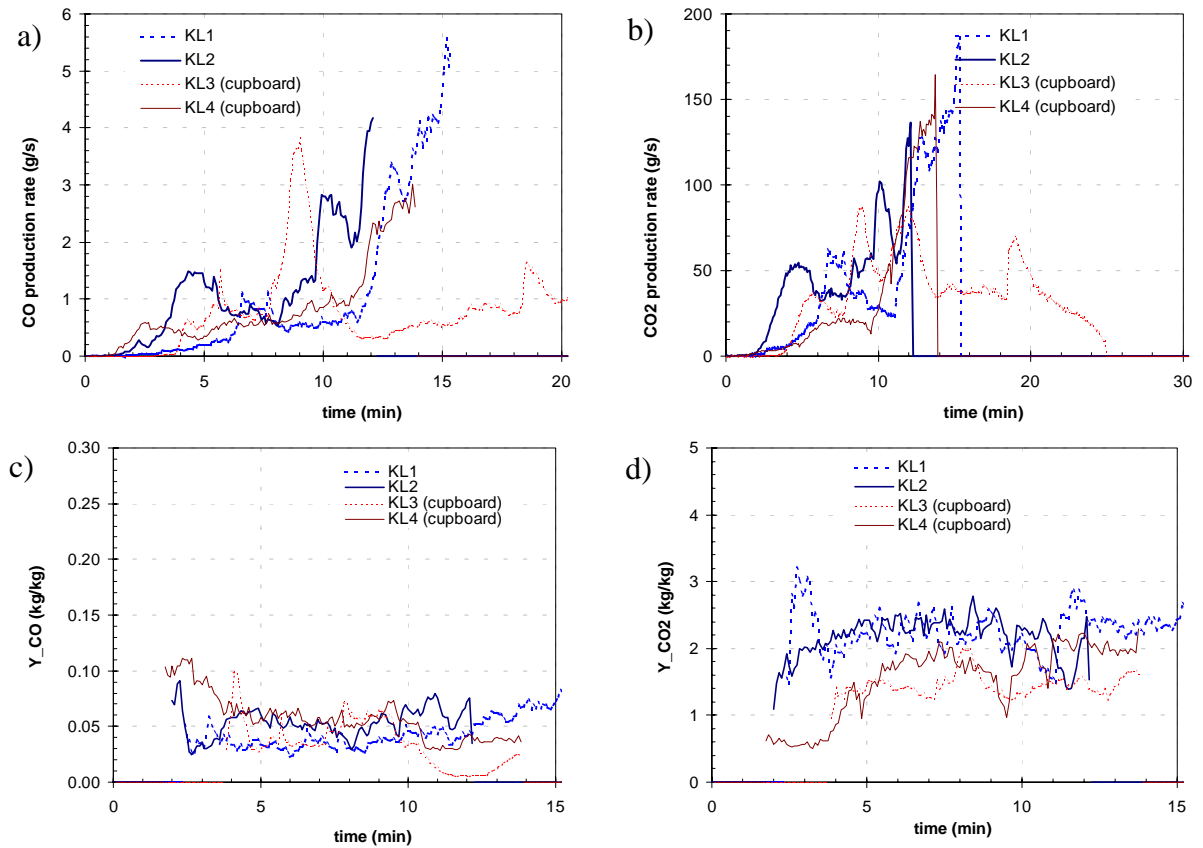

Figure 5.12. Refrigerator-freezers, CO and CO₂ production: a) RCO, b) RCO₂, c) Y_{CO} , d) Y_{CO_2} .

5.2 Tabulation of characteristic values

Characteristic values, maximum or mean values, derived from the results are presented in Table 5.1.

Table 5.1. Characteristic values derived from the results: "max." is the maximum value observed and "avg." is the mean value during the experiment¹⁾.

Apparatus	Mass	Heat		Smoke				Carbon oxides				
	ΔM ²⁾ (kg)	max. RHR (kW)	avg. EHC (MJ/kg)	max. RSP (m ² /s)	avg. SEA (m ² /kg)	max. MRSP (g/s)	avg. Y _{smoke} (kg/kg)	max. RCO (g/s)	max. RCO ₂ (g/s)	avg. Y _{CO} (kg/kg)	avg. Y _{CO2} (kg/kg)	molar ratio CO ₂ /CO
Television 1	5,2	274	31,9	8,6	904	1,07	0,113	0,986	23,3	0,068	2,683	26
Television 2	4,6	239	28,2	9,5	962	1,18	0,120	1,253	21,8	0,077	2,528	22
Television 3	5,3	211	28,6	7,4	916	0,92	0,114	0,959	16,8	0,068	2,470	26
Washing machine 1	10,1	345	31,1	2,3	190	0,28	0,024	0,651	24,7	0,056	2,158	38
Washing machine 2	10,4	431	29,9	1,7	107	0,21	0,013	0,262	30,7	0,028	2,334	64
Washing machine 3	12,3	221	35,7	1,9	201	0,24	0,025	0,335	16,0	0,031	2,806	68
Dishwasher 1	6,1	476	33,2	5,3	289	0,67	0,036	0,877	41,7	0,074	2,999	30
Dishwasher 2	8,4	347	29,3	3,6	284	0,44	0,036	0,545	26,8	0,060	2,622	34
Dishwasher 3	19,1	374	20,0	6,7	147	0,83	0,018	1,157	31,4	0,054	1,628	43
Dishwasher 4	18,6	723	19,0	3,1	121	0,39	0,015	0,684	54,9	0,041	1,606	47
Refrigerator-freezer1	18,0	2125	28,1	16,5	223	2,07	0,037	5,578	186,8	0,044	2,268	36
Refrigerator-freezer2	14,3	1816	28,1	46,3	498	5,79	0,062	4,181	136,4	0,053	2,166	27
Refrigerator-freezer3	33,6	1148	18,5	28,6	226	3,57	0,028	3,822	87,3	0,038	1,593	40
Refrigerator-freezer 4	15,3	1904	18,7	20,5	376	2,56	0,047	3,022	164,6	0,058	1,537	21

¹⁾ The mean values were evaluated for time periods corresponding to notable burning (criteria: RHR larger than 20 kW).

²⁾ The total mass lost during the experiment.

Table 5.2. Mean values evaluated for the different apparatuses and modes of installation. The numbers in parentheses depict the variability of the results (standard deviations corresponding to the mean values).

Apparatus	Mass	Heat		Smoke				Carbon oxides				
	$\Delta M^{2)}$ (kg)	max. RHR (kW)	avg. EHC (MJ/kg)	max. RSP (m ² /s)	avg. SEA (m ² /kg)	max. MRSP (g/s)	avg. Y _{smoke} (kg/kg)	max. RCO (g/s)	max. RCO ₂ (g/s)	avg. Y _{CO} (kg/kg)	avg. Y _{CO2} (kg/kg)	molar ratio CO ₂ /CO
Television sets	5,0 (0,4)	241 (32)	29,5 (2,0)	8,5 (1,0)	927 (30)	1,06 (0,13)	0,116 (0,004)	1,07 (0,16)	20,6 (3,4)	0,071 (0,005)	2,560 (0,110)	25 (2)
Washing machines	10,9 (1,2)	333 (106)	32,3 (3,1)	2,0 (0,3)	166 (52)	0,24 (0,04)	0,021 (0,006)	0,42 (0,21)	23,8 (7,4)	0,038 (0,015)	2,432 (0,335)	57 (16)
Dishwashers (free burning)	7,3 (1,6)	411 (91)	31,3 (2,8)	4,5 (1,3)	287 (3)	0,56 (0,16)	0,036 (0,0004)	0,71 (0,24)	34,3 (10,6)	0,067 (0,010)	2,810 (0,266)	32 (2)
Dishwashers (in a cupboard)	18,9 (0,4)	548 (247)	19,5 (0,7)	4,9 (2,5)	134 (18)	0,61 (0,31)	0,017 (0,002)	0,92 (0,33)	43,2 (16,6)	0,048 (0,009)	1,617 (0,016)	45 (3)
Refrigerator-freezers (free burning)	16,2 (2,6)	1970 (219)	28,1 (0,1)	31,4 (21,1)	360 (195)	3,93 (2,63)	0,050 (0,018)	4,88 (0,99)	161,6 (35,6)	0,049 (0,007)	2,217 (0,072)	32 (6)
Refrigerator-freezers (in a cupboard)	24,5 (12,9)	1526 (534)	18,6 (0,1)	24,5 (5,7)	301 (106)	3,07 (0,71)	0,038 (0,013)	3,42 (0,57)	126,0 (54,6)	0,048 (0,014)	1,565 (0,039)	30 (14)

5.3 Production of hydrogen halides

During some of the experiments the chemical compounds in the exhaust gases were measured by using FTIR technique. The FTIR measurements are described in detail in Appendix B. The FTIR system used in this study enables quantitative analysis of light-molecular weight gases such as HCN, HCl, HBr and HF and oxides of carbon, nitrogen and sulphur. In this section we considered the production of hydrogen halides (HX, X = Cl, Br or F) in more detail.

If there is no HBr in the flue gases it is rather evident that no fire retardants have been used in the plastic parts of the apparatus (or that the FR loading is low). HCl may be produced in the combustion of electrical cables or water pipes made of PVC and also by chlorine containing fire retardants. Fluorine is not usually used in fire retardants, but it is expected that some burning refrigerator-freezers may emit HF due to fluorine-containing refrigerating agents.

The halogenated emissions from fires are of importance for several reasons, for example:

- Hydrogen halides can have acute adverse effects during the fire due to their strong irritating nature. For example, irritation may impair the functioning of the persons threatened by the fire thus hampering their attempts to escape.
- In the case of retail stores and warehouses with a large number of electrical appliances, the corrosive attack to the surroundings by the hydrogen halides generated in the fire can cause considerable damage and economic losses.
- Although hydrogen halides are the most abundant class of halogenated chemicals generated by burning halogen-containing items, some trace compounds, especially chlorinated and brominated dioxins may constitute the most significant hazard.
- Halogenated compounds released from fires may also have an adverse impact on the atmospheric ozone layer.

Presently, the last two problems are under an active international debate and research (Hough 1999, Troitzsch 1999, Simonson et al. 2000).

The results of the hydrogen halide production obtained in this study are presented Table 5.3.

Table 5.3 Results of FTIR measurements concerning hydrogen halides. In results expressed in numbers, the first number tells the whole mass production during the FTIR measurement and the second number gives the yield during the FTIR time period, i.e., the mass production of HX divided by the mass lost by burning during the same time.

Apparatus	HCl	HBr	HF
TV3	below detection limit ¹⁾	below detection limit	below detection limit
PK1	below detection limit	below detection limit	below detection limit
PK2	below detection limit	below detection limit	below detection limit
AP1	67 g, or 12 g/kg	below detection limit	below detection limit
AP2	Small, close to the detection limit	below detection limit	below detection limit
KL1	123 g, or 7 g/kg	below detection limit	27 g, or 2 g/kg in relation to the total burnt mass; 193 g/kg in relation to the refrigerating agent mass of 140 g

1) In terms of concentrations, the detection limits for the FTIR system used are: HCl 23 ppm, HBr 85 ppm and HF 13 ppm. The measured concentrations are rather low due to fact that the exhaust gases were strongly diluted (the nominal exhaust flow rate in the exhaust duct was ca. 3–3.5 m³/s).

The fact that no HBr was found in the FTIR measurements suggests that the apparatuses studied were made non-fire-retarded plastics. This notion is corroborated by the fact that the intensity of burning of the apparatuses was high.

5.4 Summary of the results

Among the electrical household appliances studied, the highest rates of heat release were found in the experiments with refrigerator-freezers. Rates of heat release rising up to 2000 kW were observed[†], which is a very large heat production as compared to the size of a typical kitchen. Also for dishwashers rather high RHR levels were measured reaching peak values of 350–750 kW. Burning washing machines produced peak RHR levels of 300–450 kW; however, in relation to the typical, rather small, bath and washing room spaces that these appliances are used, such RHR levels are rather high. The maximum rates of heat release for the burning TV sets were 250–300 kW, in accordance with the other studies done with modern TV sets (Simonson et al. 2000).

The origin of the very high RHR levels of the refrigerator-freezers lies mainly in two factors. First, there are considerable amounts of plastics in these apparatuses (polyurethane as insulating material, polypropylene or polystyrene in the freezer boxes, etc.) and secondly,

[†] The experiments with refrigerator-freezers were interrupted by extinguishing by water. If the experiments had not been stopped it is probable that even higher rates of heat release than 2000 kW would have been observed.

during a fire the construction of the apparatus provides chimney-like flue enhancing the burning considerably.

For each appliance, there was a distinct delay between the starting of the heat exposure to the time when the rate of heat release started to exhibit pronounced growth. For washing machines the delay time was very long, 10–20 minutes depending on the way the apparatus was ignited. Ignition at the control panel of the washing machine led to a faster fire growth than ignition in the motor space. For the dishwashers the delay was 5–10 minutes. A similar delay was found also in the refrigerator-freezer experiments KL1, KL3 and KL4. In the experiment with the KL2 refrigerator-freezer, the delay time was clearly shorter, only 2–3 minutes. The shortest delay times were observed for TV sets: ca. 1,5 minutes for TV1 and TV2 and slightly over 3 minutes for TV3.

The total mass loss for TV sets was ca. 5 kg, or on the average 17 % of the mass of the TV sets. For washing machines the total mass loss was ca. 11 kg, corresponding ca. 16 % of the mass of the apparatuses. For the free burning dishwashers the total mass loss amounted to ca. 7 kg, or ca. 17 % of their initial mass. The free burning refrigerator-freezers lost ca. 16 kg of their mass, corresponding to ca. 24 % of the initial mass. As these refrigerator-freezer experiments were interrupted by water extinguishing at the phase of strongest burning, their mass loss results are not directly comparable to the other experiments.

The amount of heat released per unit mass, EHC, was about 30 MJ/kg for the apparatuses burned free standing. For the dishwashers and refrigerator-freezers burnt inside a particleboard cupboard, the effective heat of combustion was lower, about 19 MJ/kg, due to the participation of the particleboard to the burning.

Production of smoke per unit mass was strongest for TV sets, about 900 m²/kg or ca. 12 g/kg. For refrigerator-freezers burned both free-standing and in a cupboard, the production of smoke was ca. 300–400 m²/kg or 40–50 g/kg. In the case of dishwashers, the mode of burning (free or in a cupboard) had influence on the smoke production: for the apparatuses burned free it was ca. 300 m²/kg or 40 g/kg and ca. 150 m²/kg or 20 g/kg for those burned inside the cupboards. The finding that the mode of burning has no influence on the smoke production per unit mass for refrigerator-freezers but has a clear effect in the case of dishwashers arises from the larger relative contribution of the cupboard material producing only a little smoke in the dishwasher experiments. Of the apparatuses burned free, the lowest smoke production values were measured for washing machines: about 150 m²/kg or 20 g/kg. The rate of smoke production was highest for the refrigerator-freezers, 2–6 g/s expressed in terms of the estimated smoke mass production.

Burning of the electrical appliances produced carbon monoxide as follows: TV sets 1 g/s, washing machines 0,4 g/s, dishwashers burned free 0,7 g/s and in a cupboard 0,9 g/s and refrigerator-freezers burned free 5 g/s and in a cupboard 3,5 g/s. Expressed in terms of yields per unit mass burned, the CO production data read: TV sets 70 g/kg, washing machines

40 g/kg, dishwashers burned free 70 g/kg and in a cupboard 50 g/kg and refrigerator-freezers 50 g/kg both burning free and in a cupboard. CO production correlates well with the ratio CO_2/CO reflecting the efficiency of burning which corroborates the a priori notion that differences in CO yields are primarily due to the differences in the burning efficiency of the apparatuses, not due to e.g. differences in materials.

The carbon dioxide yields ranging from 2,2 to 2,8 kg/kg for apparatuses burned freely correspond to values typical of plastics (e.g. for polystyrene $Y_{\text{CO}_2} = 2,33$ kg/kg and polypropylene 2,79 kg/kg (Tewarson 1995)).

The burning of each appliance group is considered in more detail below.

The burning of TV sets TV1 and TV2 was essentially similar. For TV3 the development of burning was about 2 minutes slower than that of TV1 and TV2.

The washing machines PK1 and PK2 were of the same model. Also the features of the development of the rate of heat release during their burning experiments were rather similar. As compared to washing machine PK1, the rise of RHR for the washing machine PK2 was limited and delayed due to fact that the lid of PK2 remained on the apparatus throughout the experiment, whereas the lid of PK1 fell down inside the machine. In the experiment with PK3, the RHR grew considerably earlier than in experiments with PK1 and PK2 because the PK3 was ignited from the control panel on the top of the apparatus.

In the experiments with dishwashers, the influence of the cupboard was distinct. For the two machines burned inside a cupboard (AP3 and AP4), RHR started to rise steeply slightly at about 9,5 minutes. This rise in RHR denotes a flashover in the cupboard enclosure. In the experiment with apparatus AP4 the rate of heat release grew higher because the hatch of the washing space opened after a failure of the locking mechanism. Also the most distinct difference between the experiments with AP1 and AP2, i.e. the considerable faster development of RHR in the case of AP1 experiment, is related to washing space hatch. In the dishwasher AP1, the hatch did not close completely hence providing more oxygen for burning than in the experiment with AP2 where the hatch was fully closed.

The refrigerator-freezers were ignited from the motor space. A significant factor in the fire growth after ignition was the rapid spread of flames on the cardboard-like covering on the rear wall of the apparatuses. In the experiments with the free burned devices KL1 and KL2 this flame spread was easy to observe; the ignition times of the covering after the ignition source had been applied were 55 s for KL1 and 45 s for KL2. In the experiment with KL3 and KL4 enclosed in the cupboards, a direct visual observation of the flame spread along the rear-wall covering was obstructed. However, at least in the experiment with KL3 it seems evident that flame spread took place via the rear-wall covering.

In the experiments with the refrigerator-freezers KL1, KL2 and KL4 the RHR grew up to about 2 MW and the fires were put out with water. In the case of KL3, maximum RHR was slightly over 1 MW. Also the development of RHR was slower for KL3 than for the three other refrigerator-freezers. This is probably due to the fact that only in apparatus KL3 there was a metal plate between the motor space and the freezer, which delayed the fire development. Another important factor affecting the fire behaviour of refrigerator-freezers was found out to be whether the doors open or remain closed during the fire. For example, in the experiment with KL1, the rapid increase in burning at about 11 minutes was due to a flashover in the freezer initiated by the opening of the freezer door at 8,5 minutes. Opening of the doors is also visible in the KL2 and KL3 RHR curves. In the experiment with KL2, the freezer door opened at 11 minutes 10 seconds which was followed by the rise in RHR above 1500 kW. In the KL3 RHR curve two peaks are seen following the times of opening of the doors: refrigerator door at 7 minutes 15 seconds and the freezer door at 18 minutes 27 seconds.

In washing machines, dishwashers and refrigerator-freezers the combustible materials are capsulated in steel enclosures. Consequently, an incipient fire in these apparatuses has limited access of oxygen and thus the development of burning in this phase is usually slow. Sudden changes in this retarded development may take place if availability of oxygen is suddenly improved, e.g., via opening of doors or hatches or when plastic part such as wall plates or control panels burn through.

6. Considerations of the fire safety aspects

In this Chapter our goal is to give broad outlines of how the fires started from TV sets, washing machines, dishwashers and refrigerator-freezers are likely to develop in typical spaces where they are used. The assessment of potential consequences is performed simply on the basis of the temperature rise in selected scenarios. If the temperatures in the upper part of the room rise sufficiently high, i.e., to the range of 500–600 °C (Karlsson & Quintiere 2000), a danger of flashover has been deemed to be substantial.

6.1 Assessment of the development of a fire initiated by a burning electrical appliance

An electrical appliance burning in a room can spread the fire primarily through the following ways:

- Direct flame contact to adjacent objects and ignition of materials below the apparatus by dripping of flaming melted plastic,
- Ignition of objects lying close enough to the apparatus so that radiation from the flames can set them to fire,
- Generation of a hot smoky gas layer to the upper part of the room and the radiative and convective heat transfer from this layer to the walls and other items in the room; eventually this may lead to a flashover in the enclosure.

6.1.1 Flame contact and radiation

Fire spread through direct flame contact is difficult to address on a general level as it depends on the specific fire situation: how and where the apparatus is installed and what kind of items there are in its vicinity. In the experiments performed in this study, dripping of flaming plastic occurred in some way in each case. If the substrate on which the plastic drips is combustible, it may ignite and thus enhance the development of the fire.

During the early phases of fire growth the direct influence of radiation poses a danger of ignition only to objects that are rather close to the burning apparatus. As the burning approaches the maximum intensity, the risk of direct radiative fire spread increases. For TV sets and washing machines the influence of direct radiation is probably rather low. For dishwashers the risk is somewhat higher. For the fully burning refrigerator-freezers the radiation may rise to high levels even several meters away from the apparatus; yet, the relative importance of direct radiation probably remains low as compared to fire spread due to the hot gas layer.

Considering the suppression of the fire in its initial phase the heat radiation may become a crucial factor. If the fire of the ignited apparatus has not grown too large, it may be put out by, e.g., a suitable cloth (such as a carpet) or other means available in households. Such suppression entails, however, that somebody approaches the burning item. As the burning may suddenly start to increase rapidly (see e.g. the RHR curves of TV sets), the suppression of the fire may fail because the radiative influence in the vicinity of the apparatus may exceed the threshold of unbearable pain. For example, at radiation level of 8 kW/m^2 , an exposure lasting for 5 s may cause an unbearable sensation of pain (Simms & Hinkley 1960). For example, for TV sets the time from the moment when the flames become clearly visible to the time when the heat radiation may prevent approaching the TV set may be as short as half a minute.

6.1.2 Build up of the hot upper layer and flashover

In many cases the most important mode of fire spread is spreading via the hot layer formed in the upper part of the room. Below, we will consider this fire hazard for selected scenarios with the electrical appliances burning in spaces typical of their domestic use.

To get quantitative estimates of the hot layer development and temperature rise and to assess the probability of flashover, we employ two models. For the evaluation of the hot layer descent we use a simple analytical model (Zukoski 1978, Karlsson & Quintiere 2000). For the temperature-rise calculation, the Fire Dynamics Simulator program (FDS) (McGrattan et al. 2000, McGrattan & Forney 2000) developed at the National Institute of Standards and Technology (NIST), USA, has been used. The calculations and their results are described in Appendix E.

The scenarios that we consider are the following:

- TV fire in a small (8.5 m^2) room (children's bedroom) and in a 20-m^2 room (living room),
- Fire of a washing machine in a bath room of floor area of 5.5 m^2 ,
- Dishwasher fire in a kitchen of floor area of $12,5 \text{ m}^2$,
- Refrigerator-freezer fire in a kitchen of floor area of $12,5 \text{ m}^2$.

The input data used in the calculations are taken from the following experiments: television TV1, washing machine PK1, dishwasher AP4 and refrigerator-freezer KL2. We have assumed that all the rooms are separate spaces confined by four solid walls. A scenario of a TV set in children's bedroom was chosen because nowadays in Finland it is rather common to have TV sets in these room and the trend is rapidly growing. The ventilation of the rooms was assumed to take place through a 2-m high and 0,8-m wide door.

When a burning breaks out in an enclosure, the hot combustion products rise towards the ceiling and generate a layer with elevated temperature. The lower part of the room remains considerably cooler than the upper layer. If the temperature of the upper layer becomes sufficiently high the heat exposure from the layer to the ceiling, walls, floor, furniture and other items in the room may lead to ignition of all combustibles in the room, i.e., to flashover. An often-used estimate for the upper layer temperature range that may lead to flashover is ca. 500 °C – 600 °C (Karlsson & Quintiere 2000)

6.1.2.1 Smoke layer descent

As the volume of the upper layer increases, its lower interface descends. This makes escape from the fire room increasingly difficult: the heat exposure on the occupants grows causing first pain and then burn injuries. The smoke production of the burning electrical appliances is heavy and thus the visibility in the space becomes rapidly very poor. The concentration of carbon monoxide in the smoky hot layer increases rapidly; carbon monoxide may contaminate also the lower layer in rather early phases of the fire development. If the carbon monoxide concentration is high enough, inhalation of the gases may rapidly lead to disorientation, dizziness, loss of consciousness and ultimately to death.

After the initial phase of burning, fires of electrical appliances develop rapidly and generate a lot of heat. The upper layer descends quickly. In Appendix E we have estimated the time dependence of the smoke layer descent after the period of incipient burning.

The estimates depict that the times for the upper layer to reach, e.g., the half height of the room are short. They are roughly 40 s for the scenarios with the television set in a large room and a refrigerator-freezer in a kitchen, 20–30 s for the dishwasher and the TV set in the small room and only about 10 s in the case of a washing machine burning in a small bathroom. In the scenario with the TV placed in a living room the smoke filling time is about one minute. These rough estimates indicate that if the fire of an electrical appliance is detected only when there are distinctly visible flames, the time left for rescue may be very short. Such a delayed detection is likely to take place when there are no occupants or detecting devices in the room of fire origin. Also in the scenario with a TV in a children's bedroom the risks are elevated.

6.1.2.2 Temperatures

The upper layer temperatures in the above scenarios are examined in Appendix E. According to the outcome of that study, the temperatures in the above scenarios for *electrical appliances burning as single items* are the following. TV set burning in an 8,5-m² room rises the temperature to about 300–350 °C and TV burning in a 20-m² living room to 200–250 °C. Washing machine burning in a 5,5-m² bathroom yields a temperature close to 400 °C provided that ventilation is sufficient. In a kitchen of 12,5-m² floor area, dishwasher burning alone rises the temperature to about 500 °C and a burning refrigerator-freezer rises the temperature to 500–600 °C in about 3,5–4 minutes from the moment when the first small flames start inside the apparatus. The time to flashover from the moment when the flames are clearly visible (usually coming out above the apparatus) may be considerably shorter: in our simulation it is 1,5–2 minutes.

The temperature estimates given above correspond to ventilation through an open door. For TV sets, dishwashers and refrigerator-freezers this assumption is well-justified, but for washing machines the more probable case is that the door is closed. In this case the air circulation occurs through ventilation system and also through small gaps and leakages in the space.

When the door of the bathroom is closed the major factor determining the fire development is the availability of oxygen. Soon after the burning of the washing machine starts to rise rapidly, it becomes limited by the oxygen concentration and the temperatures would drop steeply. After this point, the course of the fire development depends on the particular case. The flames may die out completely or they may continue burning with a small intensity or as a smouldering fire. In the latter cases the pyrolysis gases may accumulate in the room leading to an explosive fire development if the availability of oxygen is increased, e.g., by opening the door to the room.

From the calculated temperatures, the probabilities of an occurrence of a flashover in the scenarios may be assessed.

For TV set fires even in rather small rooms, a single burning TV does not seem to produce enough heat to cause a flashover. The ignition of secondary items depends on the positions of the furniture and it does not necessarily occur. Even if fire spread beyond the TV takes place it does not necessarily lead to flashover. A quantitative examination of this issue by the FDS program is presented in Appendix E. In the study curtains of area of 3 m² were assumed to be placed close to the TV set so that they can be ignited by a direct flame contact. For the small room scenario (8,5-m² bedroom) the calculation indicates that heat release from the curtain may increase the temperature so that flashover could occur ca. two minutes after the RHR of the TV set has started to rise rapidly. For the large room scenario (20-m² living room), the calculations predict that temperatures remain below 350 °C, depicting that the ignition of the curtains probably would not lead to flashover. However, further fire development accelerated

by the heat from the curtains may lead to flashover as seen, e.g., in the room fire experiment reported by Troitzsch (1999).

The above estimates on TV fire development are in general accordance with the findings of De Poortere et al. (2000) on TV fire severities. Most of TV fires do not cause severe damage to the room of fire origin (30–40 % of TV fires remain restricted to the TV itself, 40–60 % spread beyond the TV causing damage to the property and about 5 % damage the building either severely (5 %) or completely (2 %)).

It is evident that a single-burning refrigerator-freezer in a kitchen of the size considered here would cause a flashover. Considering that rather large flames may impinge on the ceiling and items in front of the apparatus, ignition of secondary items seems rather probable.

In the case of dishwashers it seems that the heat released by the apparatuses alone may be sufficient to lead to a flashover. Also in this case, the ignition of secondary items is an important hazard; development of flashover via this fire development route seems rather probable.

For washing machines it is hard to state any general estimates about the fire development, as it is highly dependent on the particular fire situation through the availability of oxygen.

The delay time for fires started in the apparatuses with steel housing, washing machines, dishwashers and refrigerator-freezers, to develop to the point when the burning starts to increase rapidly is considerably longer than that observed for the TV sets which have a plastic case. For washing machines ignited from the control panel, the delay time was ca. 10 minutes and for washing machines ignited from the motor space, the delay time was as long as 20 minutes. For dishwashers and refrigerator-freezers the delay time was typically in the range of 5-10 minutes, with a dangerous exception provided by refrigerator-freezer KL2 for which the rate of heat release started to rise considerably only 2–3 minutes after the ignition. Thus, in most of the cases where fire has been initiated in electrical appliances with a steel housing there is more time available for the occupants to react to the fire (for suppression trials, contacting the fire brigade and escaping).

Even though a successful attempt of suppression by domestic means is feasible, it should always be borne in mind that a failing suppression attempt always delays alerting and escaping actions. For example, in the case of the refrigerator-freezer KL2, the time available for suppression trials would have been rather short as the fire developed so fast that flashover might have occurred only about 5 minutes after the first warning smoke signs started to rise from the back of the apparatus.

7. Summary

Burning characteristics of four different types of electrical household appliances have been studied experimentally. The apparatuses examined were 3 TV sets, 3 washing machines, 4 dishwashers and 4 refrigerator-freezers.

The data obtained comprise rate of heat release, mass loss and generation of smoke and some chemical substances (e.g. CO and hydrogen halides). The effective heats of combustion and yields of smoke and the chemical substances have been derived from the data. The evolution of the experiments is documented comprehensively by written records of events and photographs.

The appliances were ignited with a small propane-gas burner with the flame in contact with the appliance. This corresponds to a situation where a fault in the appliance has developed into flaming burning. Different electrical ignition mechanisms and possible smouldering phases were not addressed in the study.

High intensities of burning were detected. The highest rates of heat release (RHR), rising up to 2000 kW, were found in the experiments with refrigerator-freezers. For dishwashers rather high RHR levels, reaching peak values of 350–750 kW, were measured. Burning washing machines produced peak RHR values of 300–450 kW. The maximum rates of heat release observed for burning TV sets were 250–300 kW.

TV set fires develop rapidly: after a ca. 1,5–3-minute period of incipient low intensity burning, the fire starts to grow rapidly so that the peak value may be reached within 1–1,5 minutes from the initiation of the rapid RHR growth. For washing machines the period of incipient burning was rather long, 10–20 minutes depending on whether the apparatus was ignited in the motor space (slower fire growth) or at the control panel (faster fire growth). For the dishwashers the delay was 5–10 minutes. A similar delay was found also in three refrigerator-freezer experiments. In one refrigerator-freezer experiment, the delay time was clearly shorter, only 2–3 minutes.

A computational analysis of the development of room fires originating from ignited electrical household appliances was conducted to study the significance of the measured burning characteristics. The RHR of refrigerator-freezers is so high that fires originating from these apparatuses probably lead to flashover (if not quenched during the period of incipient burning). In the case of dishwasher fires, the likelihood of flashover is considerable. The probability of flashover TV set fires in relatively large spaces (such as living rooms) depends mainly on the probability of ignition of other items in the room. In small rooms, e.g., children's bedrooms, the TV fires are considerably more dangerous than in larger rooms. In the case of washing machine fires, the development of the fire is in practice usually governed by the availability of oxygen since the rooms with washing machines mainly have closed openings.

Smoke production was high especially for TV sets. Thus, smoke damages are likely to be considerable in fires involving electrical household appliances.

References

- Ahonen A., Kokkala M. & Weckman H. 1984. *Burning Characteristics of Potential Ignition Sources of Room Fires*. Espoo: Technical Research Centre of Finland. 48 p. (VTT Research Reports 285)
- Babrauskas, V. *et al.* 1988. *Fire Hazard Comparison of Fire-Retarded and Non-Fire-Retarded Products*. Gaithersburg, MD: National Bureau of Standards. 92 p. (NBS. Special Publication; 749)
- De Poortere, M., Schonbach, C. and Simonson, M. 2000. The Fire Safety of TV Set Enclosure Materials, A Survey of European Statistics. *Fire and Materials*, Vol. 24, no. 1, pp. 53–60.
- Choi, M. Y., Mulholland, G. W., Hamins, A. and Kashiwagi, T. 1995. *Comparisons of the Soot Volume Fraction Using Gravimetric and Light Extinction Techniques*. *Combustion and Flame*, vol. 102, pp. 161–169.
- Hough, E. 1999. *Environment Versus Safety: Another Dilemma Looming?* *Fire International*, Vol. 12, No. 169, p. 12.
- ISO 9705. 1993. *Fire Tests – Full-Scale Room Test for Surface Products*. Genève: International Organization for Standardisation. 31 p.
- Jason, N. H. 1996. *Locating Fire Information*. In: Franks, C. A. and Grayson, S. (eds.). *Interflam '96*. International Interflam Conference, 7th Proceedings. Cambridge, England, March 26–28, 1996. London: Interscience Communications Ltd., London. Pp. 691–698.
- Karlsson, B. and Quintiere, J. G. 2000. *Enclosure Fire Dynamics*. Boca Raton: CRC Press LLC. 315 p. ISBN 0.8493-1300-7
- McGrattan, K. B., Baum, H. R., Rehm, R. G., Hamins, A. and Forney, G. P. 2000. *Fire Dynamics Simulator - Technical Reference Guide*. Gaithersburg: National Institute of Standards and Technology. (NISTIR 6467)
- McGrattan, K. B. and Forney, G. P. 2000. *Fire Dynamics Simulator - Users Guide*. Gaithersburg: National Institute of Standards and Technology. (NISTIR 6469)
- Nurmi, V.-P., Säaskilahti, V.-M., Westersträhle, U. and Hämäläinen, M. 1999. Sähkö palon syttymissyynä, seurantatutkimus Vantaalla sekä pelastustoimen Kouvolan ja Kotkan yhteistoiminta-alueilla (*Electricity as an Origin of a Fire, a Follow-up Study in Vantaa and in the Rescue Services Co-operation Districts of Kouvola and Kotka*). Helsinki: Turvatekniikan keskus. 102 p. (TUKES-julkaisu 8/1999 (in Finnish.)) ISBN 952-5095-29-0

Simms, D. L. and Hinkley, P. L. 1960. *Protective Coating against Flames and Heat*. London: Department of Scientific and Industrial Research and Fire Office's Committee, Joint Fire Research Organization. Special Report No. 3.

Simonson, M., Blomqvist, P., Boldizar, A., Möller, K., Rosell, L., Tullin, C., Stripple, H. and Sundqvist, J. O. 2000. *Fire-LCA Model: TV Case Study*. Borås: Swedish National Testing and Research Institute. 212 p. (SP Report 2000:13)

Tewarson, A. 1995. *Generation of Heat and Chemical Compounds in Fires*. In: *The SFPE Handbook of Fire Protection Engineering* (2nd ed.). Quincy, MA: National Fire Protection Association.

Troitzsch, J. H. 1999. *Flammability and Fire Behaviour of TV Sets*. Presentation in a meeting: Sixth International Symposium of Fire Safety Science, 5–9 July, 1999 Poitiers, France. 15 p.

Zukoski, E. E. 1978. *Development of a Stratified Ceiling Layer in the Early Stages of a Closed Room Fire*. *Fire and Materials*, vol. 2, no. 2, pp. 54–62.

Östman, B. 1992. *Smoke and Soot*. In: Babrauskas, V. and Grayson, S. J. (eds.). *Heat Release in Fires*. London: Elsevier Applied Science. Pp. 233–250. ISBN 1-85166-794-6

Appendix A: Results of a literature survey

Before the experiments a survey was carried out on the information available in literature concerning burning of electrical household appliances. The survey was focussed on quantitative data on the ignition and fire development (especially the data on the rate of heat release). The information search relied mainly on the FIREDOC database (Jason 1996) with keywords related to the specific electrical apparatuses studied in this work, i.e., television sets, refrigerators/freezers, washing machines and dishwashers. Computer related data was also looked for.

The principal finding of the literature survey was that, with the exception of burning of TV sets, *quantitative* information on the development of burning of electrical household appliances is scarce. Especially no such data were found concerning refrigerators/freezers, washing machines and dishwashers. Some data was found on the burning of computer products.

The information obtained on the fire studies of TV sets and computers are described below. The principal selection criterion was whether the study included measurement of the rate of heat release (however, we have included results of one very interesting room fire test in which the rate of heat release was not reported). The main point emerging from these data is the importance of the plastic material of the cases and backplates.

A1 TV sets

A1.1 VTT 1984

In the experiments carried out at VTT in 1984 (Ahonen et al. 1984), three black-and-white TV sets from the early 1960ies were burned in the ISO room with floor area of 3,6 m × 2,4 m and height 2,4 m (ISO 9705, 1993). The cases of the TV sets were mainly made of wood. The backplates and some of the components contained plastics. The ignition source was 100 millilitres of isopropanol poured into a shallow tray (area of the liquid surface was 80 cm²). The ignition source was positioned inside the TV set in the lower rear left corner. The burning time of the isopropanol pool was *ca.* 10 minutes and the rate of heat release (RHR) *ca.* 4 kW. RHR (and the total heat released, THR) was determined by using the oxygen-consumption calorimetry. Temperatures T_{max} were measured above the TV set at a distance of 10 cm from the ceiling and in the centre of the ceiling. A heat flux sensor was positioned at the centre of the floor. Production and yields of smoke, CO and CO₂ (Y_{CO} and Y_{CO_2}) were determined. The effective heat of combustion (EHC) was determined from THR

and mass loss. The RHR curves of the experiments 1 and 3 are shown in Fig. A1a and the main data deduced from the tests are given in Table A1.

A.1.2 NBS 1988

At NBS, Gaithersburg, MD, USA, a large survey comparing the fire safety of different fire retarded (FR) and non-fire retarded (NFR) TV sets was carried out in 1988 (Babrauskas et al. 1988). Three experiments were done in the NBS furniture calorimeter using TV set cases, one made of NFR high-impact polystyrene (HIPS) and two made of FR HIPS. The fire-retardancy was obtained by introducing 12 weight-% of decabromodiphenyloxide and 4 weight-% of antimony oxide. The cases were of dimensions of $0,36 \text{ m} \times 0,33 \text{ m} \times 0,25 \text{ m}$, with thickness of 3 mm. Each case was closed by a steel plate. There were no functioning parts in the samples. In each test two TV cases were placed next to each other with a 25-mm gap between them. The ignition source used was a 50-kW natural gas burner with dimensions of $180 \text{ mm} \times 150 \text{ mm}$ placed 0,3 m below the gap between the TV cases. The burner was on for 200 s. Each test lasted for 600 s. The graphs of the RHR data are shown in Fig. A1b and the most important data are listed in Table A1.

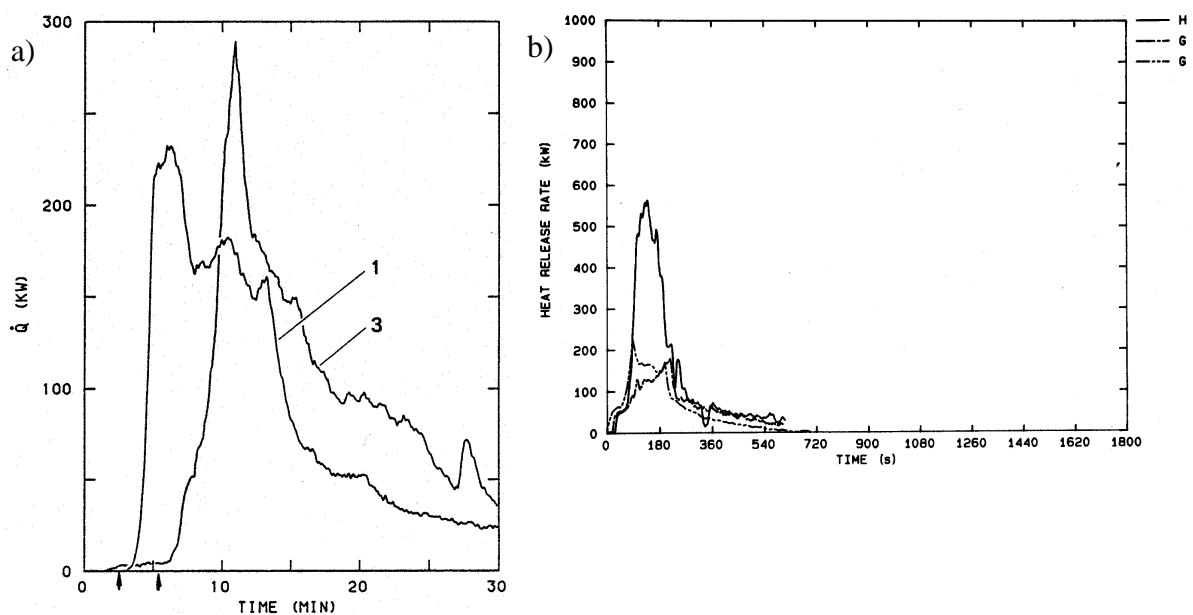

Figure A1. a) RHR in the VTT TV experiments (Ahonen et al. 1984) (the arrows depict the times of ignition) and b) RHR of TV set cases measured by Babrauskas et al. (1988) (H = NFR case and G = FR case).

Table A1. The principal results of the TV set experiments at VTT 1984 (Ahonen et al. 1984) and at NBS (Babrauskas et al. 1988).

Test no.	TV	M^1 (kg)	ΔM^2 (kg)	RHR_{max} (kW)	THR (MJ)	EHC (MJ/kg)	T_{max} (°C)	Yields (kg/kg)	
								Y_{CO_2}	Y_{CO}
VTT 1	24"	32.7	10.2	230	146	14	470		
VTT 2	24"	27.2	5.8	120			290		
VTT 3	24"	39.8	10.2	290	150	15	710		
NBS 3	Case NFR	3,7	3,6	515	83	23		1,39	0,12
NBS 4	Case FR	3,7	2,1	180	40	20		0,72	0,48
NBS 15	Case FR	3,7	2,1	175	40	20		0,75	0,26

1) M = mass of the sample.

2) ΔM = mass loss during the experiment.

A.1.3 Troitzsch 1999

Troitzsch (1999) has examined the fire safety of fire retarded and non-fire retarded TV sets. In the study old and new European, Japanese and US made TV sets were used to establish the ignitability and burning behaviour following the ignition with different ignition sources. The ignition sources and their properties are given in the Table A2. To determine the plastic type and the degree of its fire retardancy, the plastic cases of the TV sets were analysed chemically. The backing-plate materials were tested and classified according to standards used in the USA and Europe. Two full-scale room fire experiments were done to establish the development of a TV fire.

The standard UL94 "Tests for flammability of plastic materials for parts in devices and appliances" (1996) presents test methods to determine ignitability of plastics and their ignitability classification. The lowest performance class UL94 HB entails that rate of burning initiated by a Bunsen burner on a *horizontal* specimen does not exceed given limiting values. The more demanding classes UL94 V0, V1 and V2 stipulate that the burning of a *vertical* specimen extinguishes by itself within certain time periods elapsed from the quenching of the burner. For the highest class V0 the time requirement is at most 5 s and for V1 at most 25 s. If the flaming continues less than 25 s, but there occur flaming droplets capable of igniting the cotton pad below the specimen, the class is UL94 V2.

Table A2. Ignition sources used in the German TV fire test series (Troitzsch 1999).

Ignition source	Mass (g)	Flame height range (mm)	Burn time (s)	Net heat of combustion ²⁾ (MJ/kg)	Mass loss (g/min)	Heat release (W)
Solid fuel pellet	0,15	5–10	80–105	30,0	0,08–0,11	40–55
Small candle	14	10–15	¹⁾	46,2	0,04	30
Household candle	53	15–30	¹⁾	46,2	0,08	60
Piece of cloth soaked with isopropanol	4 13	200–300	210–240	30,4	3,25–3,7	1,6–1,9·10 ³
Isopropanol (200 ml)	160	600–800	120–180	30,4	53–80	27–40·10 ³

¹⁾ The candle flames were usually applied for 5 minutes.

²⁾ (Babrauskas 1992)

The outcome of the study was:

- TV set backplates are made of polystyrene (PS) and high-impact polystyrene (HIPS).
- The fire retarding substances used in TV sets are based on bromated chemicals with antimony oxide added to increase the effect.
- In the ignition tests it was found out that the fire retarded plastics usually fulfilled the requirements of the vertical UL tests (UL94 V). Plastics with no fire retardants fulfilled only the requirements of the horizontal UL94 HB test.
- In the experiments with different ignition sources it was seen that generally the FR plastics with a UL94 V ranking did not burn, while the non-FR containing HB-ranked plastics ignited easily from even the smallest ignition sources used in the study, which corresponds to heating from a short circuit or an accidental flame contact.
- The fire safety level of the older European TV sets and their backplates is usually higher than that of newer TV models available in Germany.
- New German TV sets and backplates ignited in most cases from small-power ignition sources.
- The fire safety level of TV sets purchased from Japan and USA is high.

It is concluded that to insure a high fire safety level of TV sets, the plastic cases and backplates of TV sets should fulfil the requirements of the UL94 V tests.

In the room fire experiments reported by Troitzsch (1999) there was a 25" TV in a room of dimensions of 3,52 m × 5,26 m × 2,80 m furnished according to typical continental European style. The TV set was placed in a bookshelf.

First, it was attempted to set up a room fire originating from a fire-retarded US TV. However, ignition of the apparatuses failed with ignition sources of small intensity (solid fuel pellet, small candle and household candle).

In the second phase, a TV bought in Germany was used. This TV set was ignited by a solid fuel pellet (the times quoted below have their origin at this point). Following observations were reported of the progress of the fire:

- The TV backplate began to burn 24 s after ignition.
- After 1 minute, the flames on the backplates 8–10 cm high.
- After 2 minutes 30 s the flame height reached 1 m, involving the shelf in fire.
- The curtains on left-hand side of the were burning after 6 min 30 s.
- The back rest of the sofa was burning after 6 minutes 45 s.
- The table in front of the bookshelf started to give off smoke after 6 minutes 50 s.
- Flashover with all furniture burning occurred after 7 minutes.

A.1.4 SP 2000

The Swedish National Testing and Research Institute (SP) has carried out a comprehensive set of fire experiments to study the impact of fire retardants on the environmental impact of TV fires (Simonson et al. 2000). The study comprises experiments on fire retarded (US TV) and non-fire retarded TV sets (Swedish TV) burned both as single items and items involved in a room fire. In the latter case the TV was either the first item to ignite or a secondary object ignited by the fire. The dimensions of the room were 4 m × 4 m × 2,4 m and it had a door of size 1,2 m × 2,4 m. Rate of heat release was measured in the both experiment types. Besides RHR data, abundant data of the composition of the fire exhaust gases were collected. Sample mass was measured for the TV sets burned as single items. RHR data measured for the free burned TV sets are shown in Fig. A2a and the data obtained in the room fire experiments in Figs. A2b, c and d.

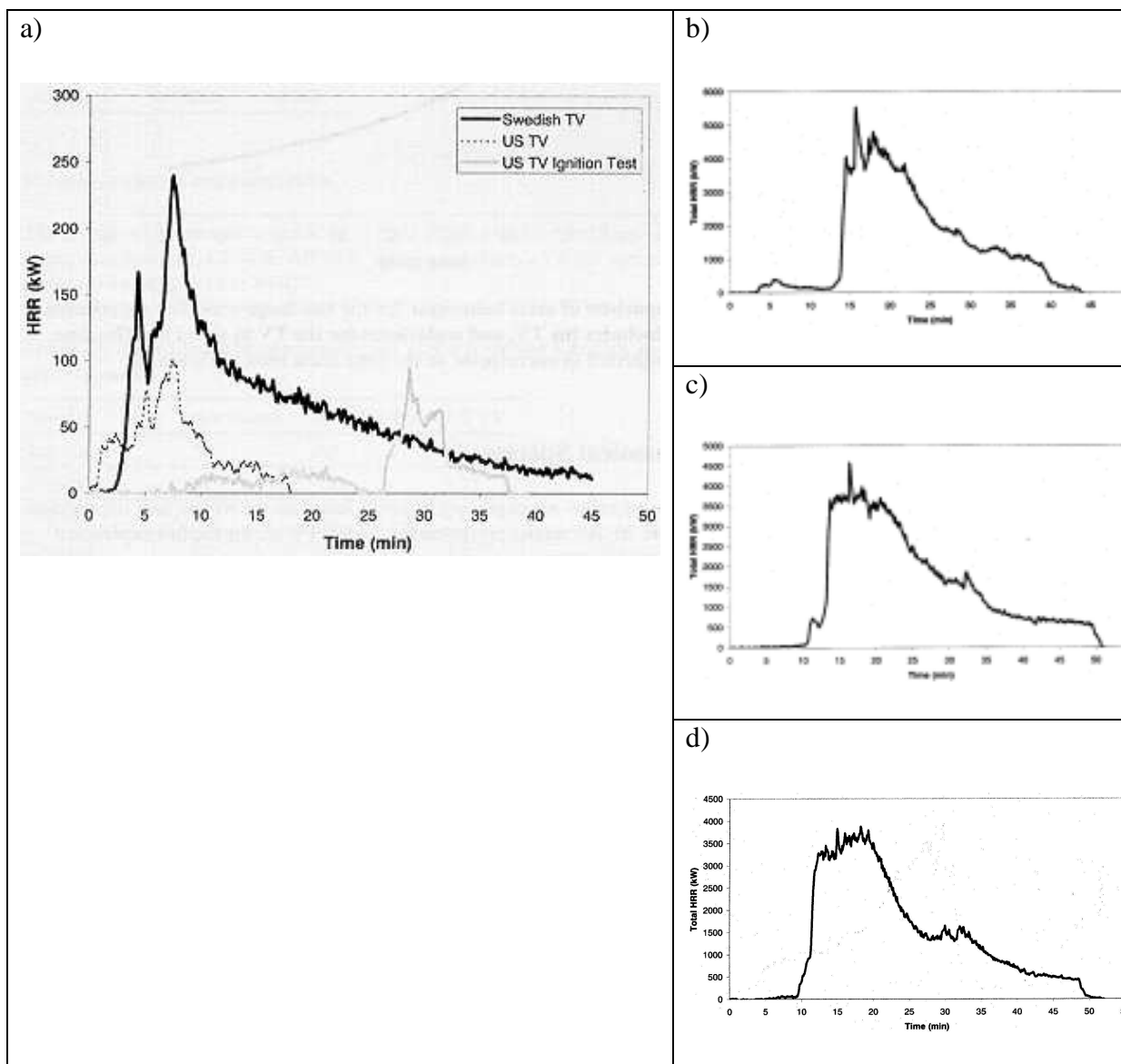

Figure A2. RHR curves measured in the TV set experiments at SP: a) free burning TV sets, b) room fire experiment with the Swedish TV as the first item ignited, c) sofa as the first item ignited and a US TV in the room, d) sofa as the first item ignited and a Swedish TV in the room.

The non-fire retarded TV was ignited by a butane-gas burner with output of ca. 0,5 kW. The TV set ignited ca. 30 s after the application of the igniting flame. The rate of heat release peaked at 240 kW, see Fig. A2a. The fire retarded TV could not effectively be ignited by the 0,5-kW ignition source. The data showed in Fig. A2a as “US TV” was obtained by igniting the fire retarded TV by a 30-kW burner.

In the first room fire experiment, the time elapsed from the ignition to flashover was 14,5 minutes, 13,5 minutes in the seconds experiment and 13 minutes in the third experiment (occurrence of flashover was determined from the ignition of the floor covering). In the first

and second experiment, flashover took place after the armchair beside the TV had ignited. In the third experiment, the TV exploded at 14 minutes 35 seconds after the ignition of the sofa.

A.2 Computers

A2.1 Packed computer products

Hasegawa et al. (1999) have carried out experiments to study fire performance of computer products packed and loaded on pallets. As a preliminary investigation they carried out studies also on single packed products, see Table A3. In the experiments, the rate of heat release, intensity of heat radiation and total energy were measured. The samples were ignited by a propane-gas burner producing a power of 20 kW. The heat release rates obtained are shown in Fig. A3. The overall rate of heat release of the computer products and their packaging rises up to 400 kW.

Table A3. Information about the computer products and materials burned in preliminary experiments of Hasegawa et al. (1999).

Product	Mass (kg)
1. Monitor	16,752
Single wall corrugated box	1,289
Polystyrene packing	0,337
2. Language packs (30 Software)	0,561
Keyboard	2,263
Corrugated cardboard keyboard carton	0,278
Plastic bag	0,036
3. Laptop computer	2,476
Corrugated cardboard box	0,756
Polystyrene foam packing	0,182
4. Desktop computer 0,53 m × 0,24 m × 0,55 m	4,9
Single walled corrugated cardboard box	0,908
Polystyrene foam packing	0,125

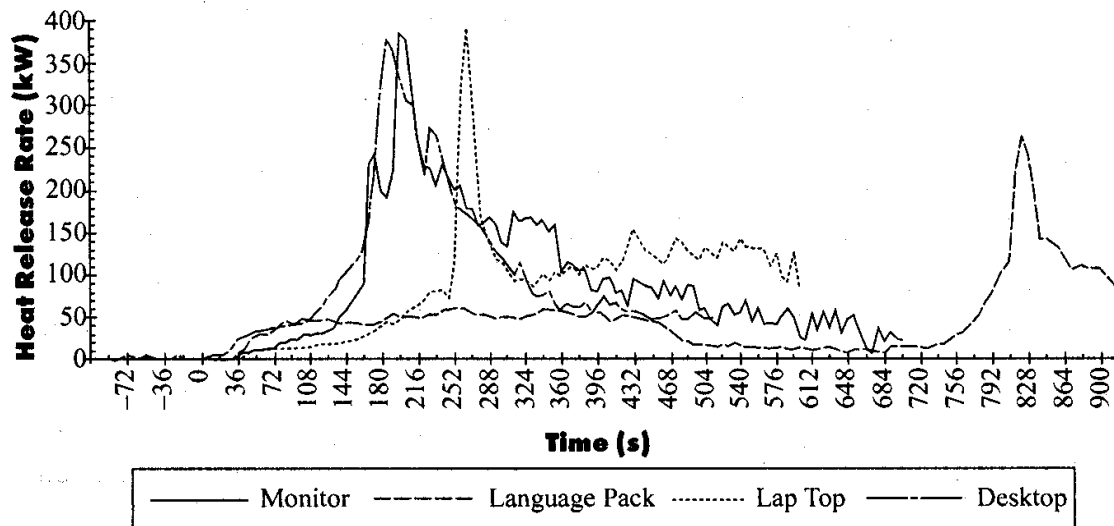

Figure A3. RHR data of the preliminary experiments of Hasegawa et al. (1999).

A2.2 Fire tests of video display terminals

The Swedish National Testing and Research Institute (SP) has carried out fire experiments on video display terminals for the National Association of State Fire Marshals (USA) (Simonson 1999). In the experiments the ignitability of five video display terminals was studied using three ignition sources:

1. Match, exposure time ca. 30 s
2. Candle flame yielding a closely similar heat exposure as a match but with exposure time elongated to 5 minutes.
3. Ball of paper producing a flame of height of ca. 10 cm. The exposure lasted for about 1,5 minutes. The paper ball was made of two A4-sized sheets of paper.

The plastic cases of three video display terminals fulfilled the requirements of the standard UL94 V0, one of them had an UL94 HB classification and one of them did not fulfil the UL94 V requirements but was assumed to fulfil the UL94 HB requirements.

The experiments were done in a room furnished to simulate children's bedroom. The size of the room was 2,4 m × 3,6 m × 2,4 m (ISO 9705, 1993). The UL94 V0 classified cases were tried to be ignited by using the above mentioned three different ignition sources (in the order indicated). None of the sources was able either to ignite the UL94 V0 classified cases or to generate sustained flaming. Both of the UL94 HB classified cases ignited easily with the flame of a match, continued burning after the ignition and produced a room fire large enough to cause flashover in the room.

References

- Ahonen A., Kokkala M. & Weckman H. 1984. *Burning Characteristics of Potential Ignition Sources of Room Fires*. Espoo: Technical Research Centre of Finland. 48 p. (VTT Research Reports 285)
- Babrauskas, V. *et al.* 1988. *Fire Hazard Comparison of Fire-Retarded and Non-Fire-Retarded Products*. Gaithersburg, MD: National Bureau of Standards. 92 p. (NBS. Special Publication; 749)
- Babrauskas, V. 1992. *Heat of Combustion and Potential Heat*. In: Babrauskas, V. and Grayson, S. J. (eds.). *Heat Release in Fires*. London: Elsevier Applied Science. Pp. 207–224. ISBN 1-85166-794-6
- Hasegawa, H. K., Alvares, N. J. & White, J. A. 1999. *Fire Tests of Packaged and Palletized Computer Products*. *Fire Technology*, vol. 35, no. 4, pp. 291–307.
- ISO 9705. 1993. *Fire Tests - Full-Scale Room Test for Surface Products*. Genève: International Organization for Standardisation. 31 p.
- Jason, N. H. 1996. *Locating Fire Information*. In: Franks, C. A. and Grayson, S. (ed.). *Interflam '96. International Interflam Conference, 7th Proceedings*. Cambridge, England: March 26–28, 1996. London: Interscience Communications Ltd., London. Pp 691–698.
- Simonson, M. 1999. SP Report 99 R31151. Borås: Statens Provningsanstalt. 14 p. Available at: <http://www.firesafety.org/News/NewsFrame.htm>
- Simonson, M., Blomqvist, P., Boldizar, A., Möller, K., Rosell, L., Tullin, C., Stripple, H. and Sundqvist, J. O. 2000. *Fire-LCA Model: TV Case Study*. Borås: Swedish National Testing and Research Institute. 212 p. (SP Report 2000:13)
- Troitzsch, J. H. 1999. *Flammability and Fire Behaviour of TV Sets*. Presentation in a meeting: Sixth International Symposium of Fire Safety Science, 5–9 July, 1999 Poitiers, France. 15 p.
- UL 94. 1996. Underwriters' Laboratories. *Tests for Flammability of Plastic Materials for Parts in Devices and Appliances*. Fifth edition.

Appendix B: FTIR measurements

In connection with the experimental study of fire performance of electrical household appliances, FTIR (Fourier Transform InfraRed) measurements were performed from the combustion gases in order to observe gas components with potential environmental hazard, e.g., compounds containing halogens. The main advantages of the FTIR methodology compared to many traditional gas analysis methods are that the results are time-resolved, enabling the monitoring of how species develop throughout the fire, and that several species can be monitored simultaneously.

The experimental arrangement of the FTIR measurements is presented in Figure B1. The set-up consisted of a probe made of stainless steel, a heated filter, a heated sampling line, a FTIR spectrometer, a pump and a flowmeter. The gas sample was led through the sampling line to the gas cell of the FTIR spectrometer for concentration measurements. The FTIR spectrometer used was a Michelson MB 100 AZ with a DTGS detector.

In the beginning of the test series, an open-ended single-hole probe was used. The probe was made of stainless steel tube with an inner diameter of 5 mm. The sampling hole was positioned in the geometrical centre of the exhaust duct. During the test series, however, it was noted that this sampling arrangement was unsuccessful in case of high flow velocities in the exhaust duct, necessary in tests with severe burning. In these tests, the suction of the FTIR sampling line was insufficient to collect the gas sample with a single-hole probe. Thus, the probe was modified by drilling five additional holes on the side of the probe, positioned downstream in respect of the duct flow. The diameter of these holes was 3 mm and their spacing was 50 mm. This multi-hole probe functioned better with high duct velocities. However, the FTIR concentrations measured were scaled with a correction factor obtained by comparing the FTIR results of CO₂ and CO to NDIR measurements performed in connection with the rate of heat release measurement.

The experiments in which FTIR measurements were performed are listed in Table B1.

Table B1. List of experiments with FTIR measurements.

Experiment	Notes
RHR calibration	Propane
PVC saturation	PVC sheets + wood cribs
PVC calibration	PVC powder, heptane for ignition
Television 0	TV on particleboard rack
Television TV 1	FTIR sampling failure
Television TV 2	FTIR sampling failure
Television TV 3	
Washing machine PK 1	
Washing machine PK 2 (first trial)	Burner blocked by melted plastics before ignition of the washing machine
Washing machine PK 2 (second trial)	
Dishwasher AP 1	
Dishwasher AP 2	
Refrigerator-freezer KL 1	

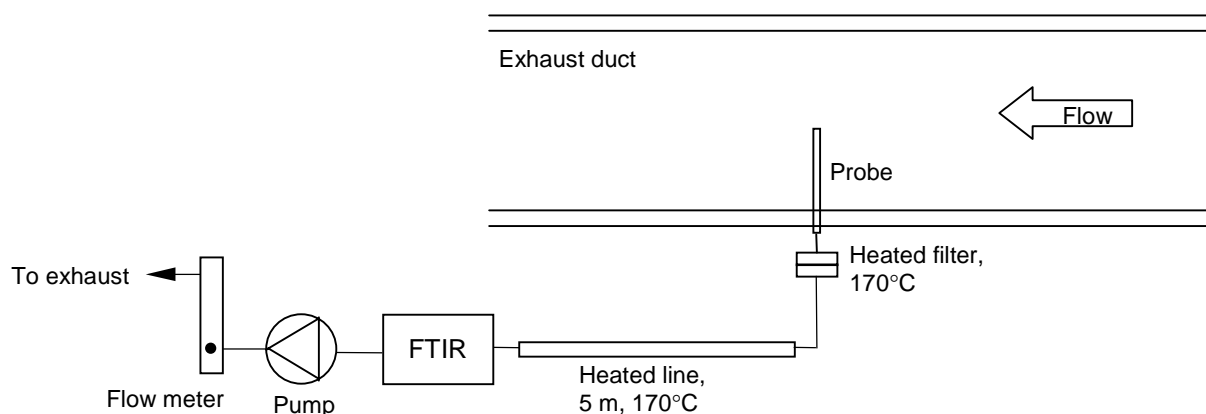

Figure B1. Schematic diagram of FTIR test arrangements (not to scale).

The FTIR analyses were performed by peak area method. The minimum detection limits of the compounds of interest are summarised in Table B2. It is noted that even smaller concentrations can be seen in the spectra in some cases but the concentration analysis is unreliable below the minimum detection limit.

Table B2. Minimum detection limits of Michelson MB 100 AZ FTIR spectrometer.

Gas	Concentration of reference gas (ppm)	Peak wavenumber (cm⁻¹)	Maximum peak height (A.U.^{*)}	Minimum detection limit (ppm)
CO	50	2178	0,02605	21
CO₂	100	3730	0,02908	37
HCN	10	714	0,09537	1
HCl	100	2963	0,04716	23
HBr	200	2635	0,0254	85
HF	50	3832	0,04233	13

^{*)} Arbitrary Units

RHR calibration

This test was performed to confirm the correctness of the rate of heat release measurement. FTIR measurement was carried out to check the functioning of the FTIR spectrometer and sampling arrangement. The need for the FTIR correction factor was noticed on the basis of this test, but the sampling problem related to high duct velocities was not revealed due to the moderate volume flow used.

PVC saturation

HCl has a tendency to be adsorbed on the inner surface of the sampling line. Pre-ageing of the line reduces the adsorption of HCl. Thus, PVC sheets with wood cribs were burned to saturate the sampling line with HCl. Small concentrations of HCl were seen in the FTIR spectra throughout the burning. However, concentration or yield analysis was not performed.

PVC calibration

In this test, a pile of PVC powder was burned in order to verify the HCl saturation of the sampling line. The mass loss of the PVC powder was 174,9 g. Since the theoretical maximum yield of HCl from burning PVC is 0,584 g/g, the expected maximum HCl yield is 102 g. The HCl yield measured was 106 g. The slight difference between the values is probably due to the inaccuracy of the FTIR correction factor used. However, the HCl saturation of the sampling line appeared to be successful and no major adsorption losses in the actual tests were expected.

Television 0

HCl production was observed in the test of television 0. The shape of the HCl concentration curve was similar to the RHR curve. The total HCl yield was 88 g over 26 minutes.

Some hydrocarbon peaks were seen in the spectra. The most distinct of these was caused by toluene $C_6H_5CH_3$, appearing soon after the ignition and seen in small concentrations throughout the flaming period.

Televisions 1 and 2

The FTIR measurements in the tests of televisions 1 and 2 failed due to the sampling problem described above.

Television 3

The main components in the FTIR spectra of television 3 were water vapour, CO_2 and CO. In addition, hydrocarbon peaks were seen in the spectra. Similarly to television 0, toluene $C_6H_5CH_3$ appeared in small concentrations. No HCl, HBr, HCN or HF was observed.

Washing machine 1

The FTIR spectra of washing machine 1 were mainly composed of water vapour, CO_2 and CO. In addition, hydrocarbon peaks (e.g. methane CH_4 and ethylene C_2H_4) were seen in the spectra. No HCl, HBr, HCN or HF was observed.

Washing machine 2/2b

The test of washing machine 2 was interrupted in its early phase due to self-extinction of the ignition burner. The flame was suffocated by melted plastic accumulating on the burner. After cleaning the burner, the test was re-started under the name "washing machine 2b".

The FTIR spectra of the washing machine 2b were mainly composed of water vapour, CO_2 and CO. Small amounts of hydrocarbons (e.g. ethylene C_2H_4) could be seen in the spectra. No HCl, HBr, HCN or HF was observed.

Dishwasher 1

Dishwasher 1 produced HCl during its most intense burning period. The total yield of HCl was 67 g over 22 minutes. Hydrocarbon peaks (e.g. methane CH_4 and ethylene C_2H_4) were also seen in the FTIR spectra.

Dishwasher 2

Small concentrations of HCl, close to the minimum detection limit, were observed in the spectra of dishwasher 2. The HCl analysis was further complicated by hydrocarbons appearing on the same spectral region as HCl. However, the HCl production of dishwasher 2

was clearly lower than that of dishwasher 1. Peaks of methane CH_4 and ethylene C_2H_4 were identified in the spectra.

Refrigerator-freezer1

HCl was observed during the most intense burning of the refrigerator-freezer1. The total yield of HCl was 123 g during the first 17 minutes of the test. HCl concentration was increasing when the test was interrupted due to severe burning.

A short-termed peak of HF was seen at about 10 minutes when the freon coolant of the refrigeration device 1 was burning. The total yield of HF was 27 g.

Additionally, various hydrocarbon peaks were observed during the burning of refrigerator-freezer 1.

Appendix C: Results of the preliminary TV experiment

A preliminary experiment was carried out using a rather old TV set to check the measurement system and procedures. The graphs of the rate of heat release, mass loss and effective heat of combustion are shown in Fig. C1. To facilitate the comparison with the other TV set experiments, also the results of these experiments are given.

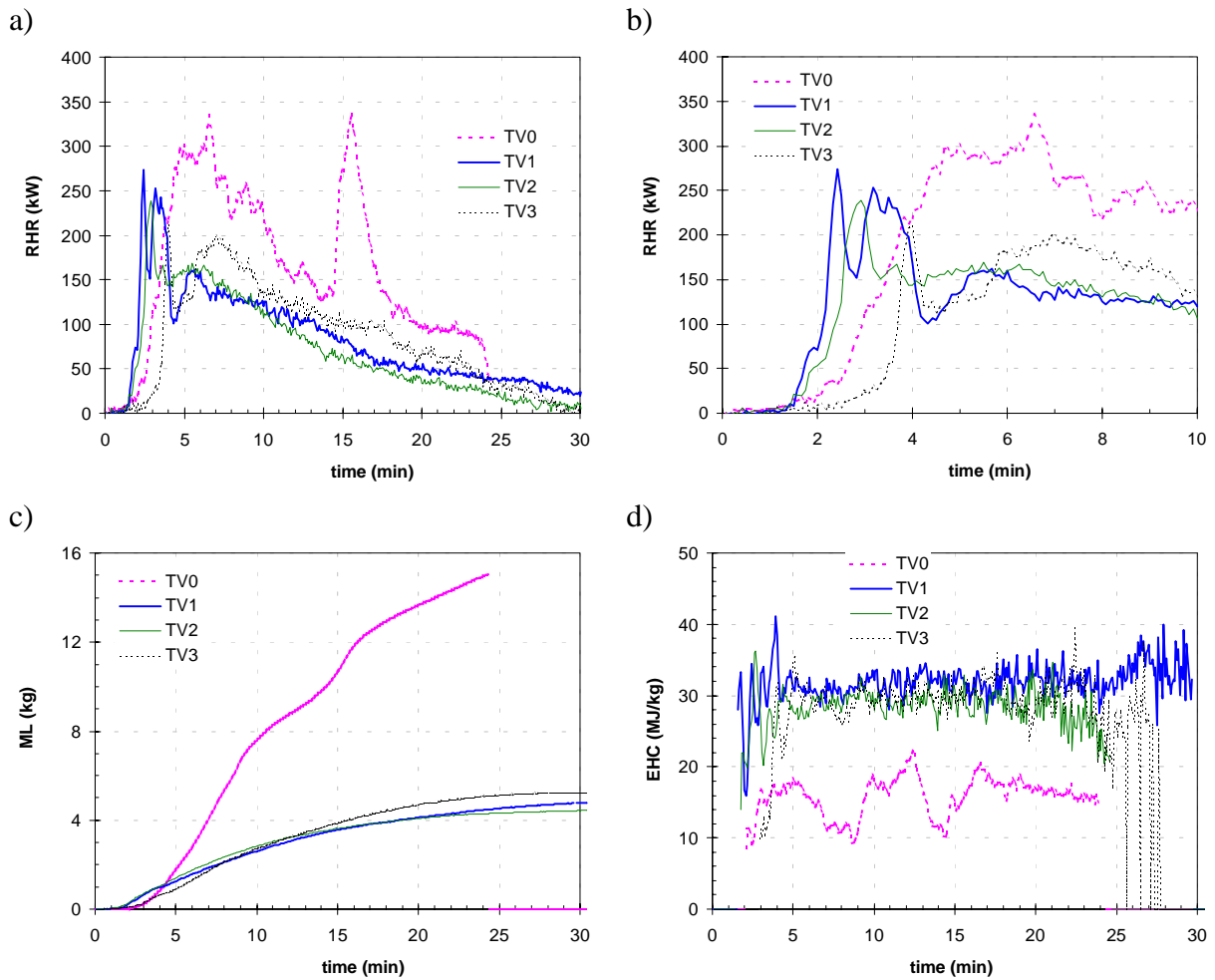

Figure C1. TV sets: a) RHR (time 0–30 min), b) RHR (time 0–10 min), c) ML and d) EHC.

Appendix D: On the fire growth rate

The initial phases in the graphs of rate of heat release can be characterised to some extent by the t^2 -description $RHR = \alpha \cdot (t - t_0)^2$ where α is a factor quantifying the growth rate (Schifiliti et al. 1995). The parameter t_0 is related to the delay of substantial RHR development. An alternative way to express the t^2 dependence frequently used is $RHR = 1000 \text{ kW} \cdot \left((t - t_0) / t_{\text{growth}} \right)^2$ where $t_{\text{growth}} = \sqrt{(1000 \text{ kW}) / \alpha}$.

Inspection of the RHR curves presented in section 5.1 shows that not all of them can be meaningfully described by simple parabolic time dependence. The experiments to which the description was employed and the parameters derived through least-squares fitting are given in Table D1. The numbers characterise only the first rise in the RHR curves.

Table D1. Parameters of the t^2 time dependence description.

Apparatus	parameter t_0 (s)	growth factor α (kW/s ²)	growth time t_{growth} (s)	Characterisation
TV1	100	0,138	85	fast
TV2	100	0,055	135	fast
TV3	188	0,098	100	fast
PK3	444	0,0014	845	slow
AP1	200	0,012	290	medium
KL2	89	0,029	185	medium

The growth rates vary considerably spanning the range found e.g. in studies of upholstered furniture, $\alpha = 0,003\text{-}0,5 \text{ kW/m}^2$ (Schifiliti 1995).

References

Schifiliti, R. P., Meacham, B. J. and Custer, R. L. P. 1995. *Design of Detection Systems*. In: The SFPE Handbook of Fire Protection Engineering (2nd ed.). Quincy, MA: National Fire Protection Association.

Appendix E: Hazard calculations

In this Appendix we examine fire hazards related to burning of electrical household apparatuses quantitatively using simple analytical models. The scenarios we consider are the following:

- Two TV fire scenarios: one simulating a fire started in a TV set placed in a small bedroom with height of 2,6 m and area of 8,5 m² and the other addressing a TV fire in a 20-m² room of height 2,6 m (a living room),
- Washing machine fire in a bathroom of height 2,6 m and area of 5,5 m²,
- Burning of a dishwasher in a kitchen separated from the other spaces in the apartment by walls. The height of the kitchen is assumed to be 2,6 m and the area 12,5 m²,
- Burning of a refrigerator-freezer in a kitchen separated from the other spaces in the apartment by walls. The height of the kitchen is assumed to be 2,6 m and the area 12,5 m² (the same space as that examined in the dishwasher case).

E1 Height of the hot layer

During the initial phases of hot-layer formation, its descending can be estimated by the following differential equation (Zukoski 1978, Karlsson & Quintiere 2000)

$$A_{\text{room}} \rho_{\infty} \frac{dz}{dt} + \frac{\dot{Q}}{c_p T_{\infty}} + 0,071 \dot{Q}^{1/3} z^{5/3} = 0, \quad (\text{E1})$$

where z is the height of the interface between the upper hot layer and the cooler lower layer. Initially z equals the room height H and diminishes when the smoke from the fire releasing heat at a rate \dot{Q} (unit: kW) starts to accumulate in the upper parts of the room. The other symbols are: t is time, A_{room} is room floor area, T_{∞} is the ambient temperature, c_p is the specific heat[†] and ρ_{∞} is the density of air at ambient temperature and g is the acceleration of gravity. It should be noted that Eq. (E1) gives estimates on the safe side, as it does not include any terms representing smoke flow away from the room (e.g., smoke escaping below the door lintel as the layer interface descends below is not taken into account). We focus the study to the hazardous period of time when the burning of the apparatuses starts to grow rapidly and, hence, any smoke production prior to this time period has been omitted.

[†] Note that the specific heat is expressed in units of kJK⁻¹kg⁻¹.

The times of the smoke descent are small (see Fig. E1), e.g., the times to reach the half height of the room range from the time of ca. 10 s for the washing machine in the small enclosure (5,5 m² bathroom) to about 40 s for the TV fire in the large enclosure (20 m² living room).

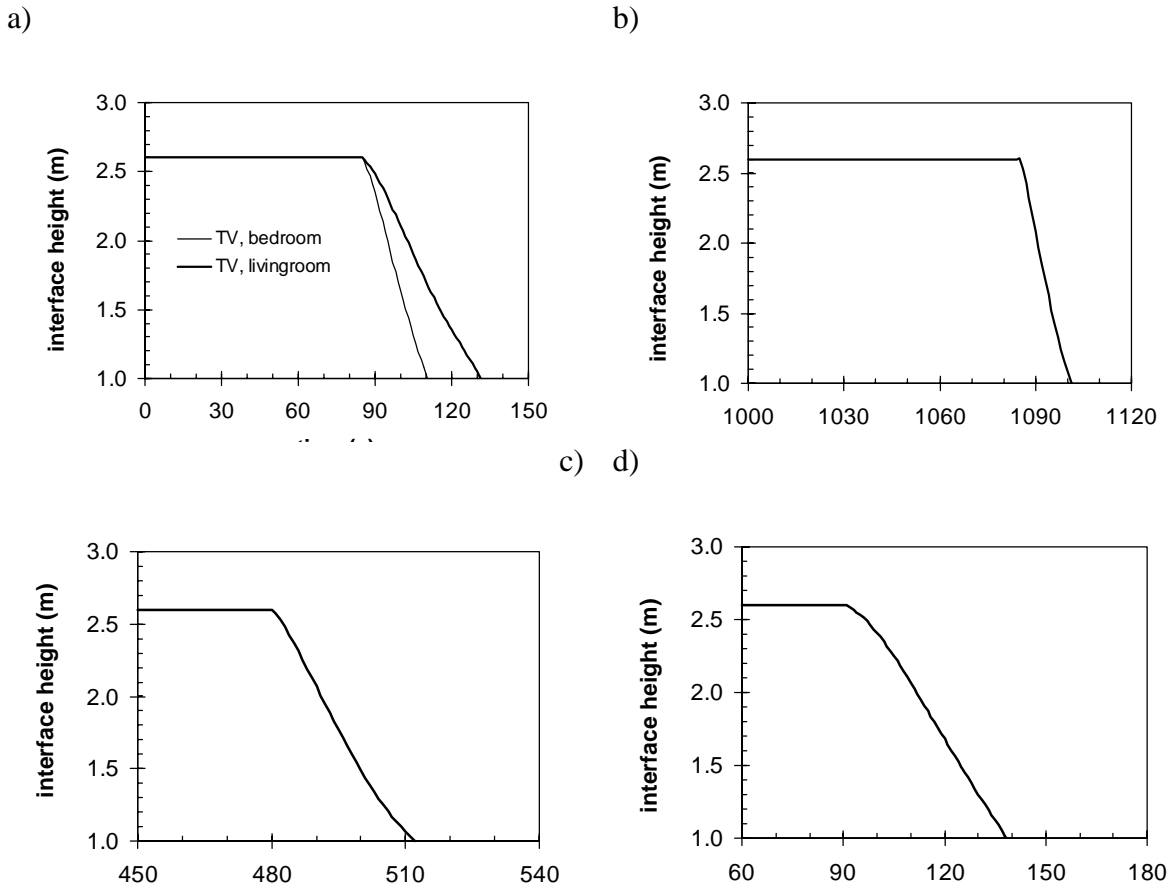

Figure E1. Upper layer interface height as function of time calculated through numerical solution of Eq. (E1): a) TV set TV1 in a bedroom (8,5 m²) and in a living room (20 m²), b) washing machine PK1 in a bathroom, c) dishwasher AP4 in a kitchen (12,5 m²) and d) refrigerator-freezer KL2 in a kitchen (12,5 m²).

E2 Temperature rise and flashover

Rise of temperature due to a fire in a room depends on the balance between heat gains and losses. The primary heat source is the heat released by the first item ignited. When the fire evolves further also other items (furniture, boundaries, etc.) become sources of heat if they ignite. Heat is lost from the gases in the room through convective and radiative heat transfer to the enclosure boundaries or via flow through the openings of the room. The heated boundaries emit heat radiation that partially escapes from the room through its openings.

Due to non-complete combustion, combustible volatiles accumulate in the hot upper layer that forms in the room. If the layer becomes hot enough ignition of these gases takes place accompanied by involvement of virtually all combustible surfaces and objects in the room, i.e., flashover occurs. An often quoted critical temperature for the occurrence of flashover is 500 °C–600 °C (Karlsson & Quintiere 2000).

Though easily described, the dynamics of an enclosure fire are tedious to model because there are non-linear interactions between the different factors. It is hard to quantify these interactions rigorously without modelling the full 3-dimensional flow and heat transfer system. Such models require laborious computerised calculations. Fortunately, the rapidly increasing power of computers combined with the ingenious results emerging from ample research in the field is making such computational tools increasingly practicable and easy to use (the latter is an important feature for those fire scientists and engineers who are not dedicated specialist in the field of computational fluid dynamics).

In this study we have used the Fire Dynamics Simulator program (McGrattan et al. 2000, McGrattan & Forney 2000) developed at the National Institute of Standards and Technology (NIST), USA, to analyse the fires originating from burning electrical appliances. This program is based on the Large-Eddy description of the flow field dynamics in the enclosure. The coupling between the heating of the enclosure and objects in it and the rate of heat release in the enclosure has been taken into account by a robust model, which is easily adopted and implemented. The program can be downloaded free of charge from the NIST Internet site.

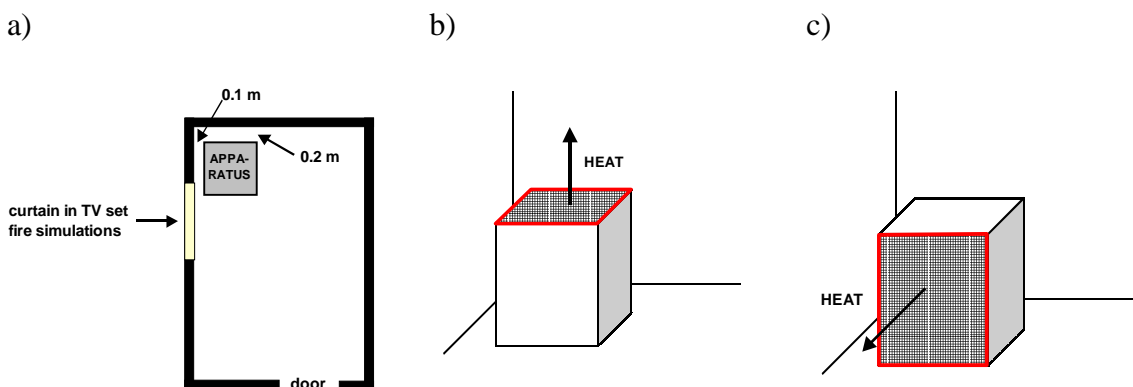

Figure E2. a) Schematic drawing showing the basic geometrical relations of the simulations and description of the modes of heat release by b) TV set and washing machine and c) dishwasher and refrigerator-freezer. The area depicted with the mesh-texture denotes the heat-releasing area.

To characterise the fire case to be simulated, the program requires the following input data: dimensions of the room and the computational grid, characteristic of the boundaries, the rate of heat

release from the first item ignited as well as location and characteristics of the other items potentially placed in the room.

In our simulations, all boundaries[†] of the room were assumed to be made of 0,1-m thick material with thermal properties resembling those of gypsum board (thermal conductivity $0,48 \text{ WK}^{-1}\text{m}^{-1}$ and thermal diffusivity $4,1 \cdot 10^{-7} \text{ m}^2/\text{s}$). The rate of heat release data for the different apparatuses were taken from the following experiments: TV set TV1, washing machine PK3, dishwasher AP1 and refrigerator-freezer KL2. The apparatuses were assumed to be positioned in the corner of the room as sketched in Fig. E2a. The TV set and washing machine were assumed to release heat from their upper surface (see Fig. E2b) and the dishwasher through its hatch opening and the refrigerator-freezer via its doors (see Fig. E2c).

The results of the FDS calculations are shown in Figs. E3, E4, E5 and E6, corresponding to TV set, washing machine, dishwasher and refrigerator-freezer, respectively. The temperatures given are readings from a virtual temperature sensors placed 10 cm below the ceiling. The TV fire cases include also an estimate how ignition of a secondary item, a curtain, would elevate the temperatures.

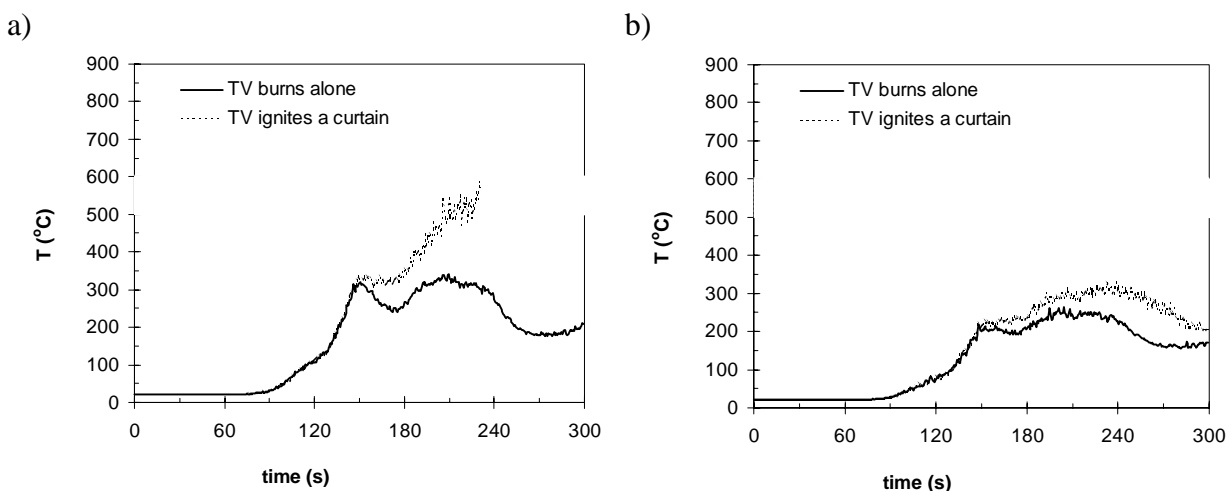

Figure E3. Simulation of a TV set fire in a room of area of a) $8,5 \text{ m}^2$ and b) 20 m^2 : Estimates for the temperatures 10 cm below the 2,6-m high ceiling. Ventilation of the rooms takes place through an open door with height of 2 m and width of 0,8 m. The thick solid curves depict the temperatures when the TV set is burning alone and the thinner dashed curves show an estimate how heat from a curtain ignited as a secondary item would rise the temperatures. The grey region depicts a temperature range of 500–600 °C.

[†] For simplicity, the floor was assumed to be made of the same material as the walls and ceiling. This simplification does not affect the results. As check of this, we simulated a TV fire in a small bedroom with a fully adiabatic floor. The temperatures remained practically the unaltered.

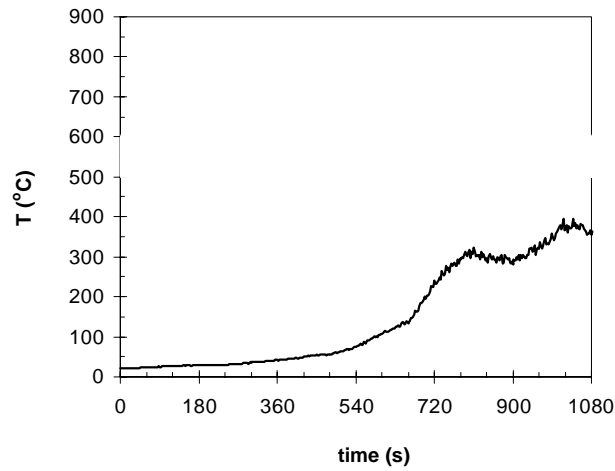

Figure E4. Simulation of a washing machine fire in a bathroom of area of $5,5 \text{ m}^2$: estimates for the temperatures 10 cm below the 2,6-m high ceiling. Ventilation of the room takes place through an open door with height of 2 m and width of 0,8 m. The washing machine is the only item burning in the enclosure. The grey region depicts a temperature range of 500–600 °C.

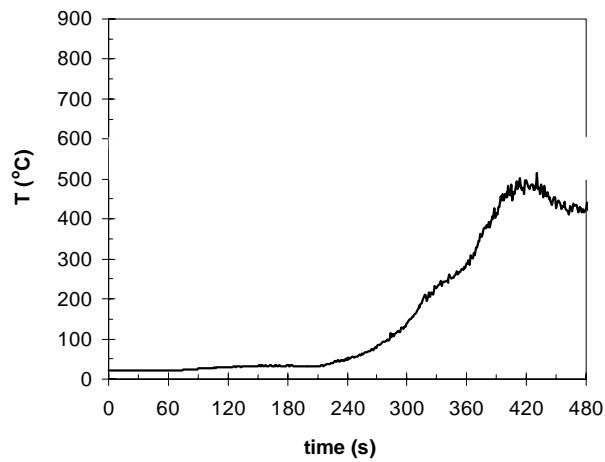

Figure E5. Simulation of a dishwasher fire in a kitchen of area of $12,5 \text{ m}^2$: estimates for the temperatures 10 cm below the 2,6-m high ceiling. Ventilation of the room takes place through an open door with height of 2 m and width of 0,8 m. The dishwasher is the only item burning in the enclosure. The grey region depicts a temperature range of 500–600 °C.

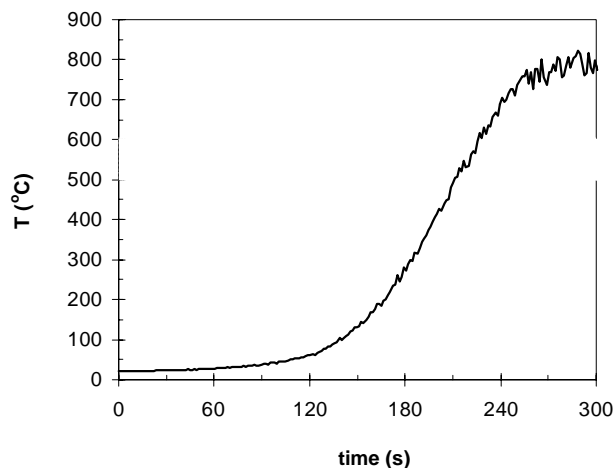

Figure E6. Simulation of a refrigerator-freezer fire in a kitchen of area of 12,5 m²: estimates for the temperatures 10 cm below the 2,6-m high ceiling. Ventilation of the room takes place through an open door with height of 2 m and width of 0,8 m. The refrigerator-freezer is the only item burning in the enclosure. The grey region depicts a temperature range of 500–600 °C.

A curtain was chosen to simulate secondary ignition because with respect to fire risks, curtains constitute one hazardous class of the furnishing items. They may ignite easily and after the ignition the fire may grow rapidly. For example, in TV room fire experiment reported by Troitzsch (1999), the fire initiated in the TV spread to curtains at about 6,5 minutes. Shortly after this, after ignition of the sofa and the table in front of the sofa, there was a flashover in the room. Judging by the temperatures measured in the experiment it may be estimated that the curtains were set on fire about 2,5 minutes after the TV fire started to grow rapidly.

The burning of curtains has been modelled using as basic information the curtain fire tests made at SP (Wetterlund & Göranson 1988). In these tests with a curtain sample size of 9 m², the rate of heat released by an acrylic curtain increased up to ca. 1500 kW in about half a minute and the RHR of a curtain made of cotton increased to ca. 800 kW in about the same time, half a minute. To estimate the RHR curves for our calculations with smaller size curtains, we scaled down the magnitude of RHR and its temporal evolution. From the down-scaled data it can be estimated that, e.g., an acrylic curtain of size of 3–4 m² may produce an RHR peak close to 600 kW in about 25 s after its ignition. The time delay to the ignition of the curtains after the initiation of the rapid RHR development has been assumed to be 2 minutes.

In the FDS implementation we characterised the curtains by an ignition temperature of 250 °C and RHR-per-unit-area value of 200 kW/m². The curtains were assigned a size of 3 m² and they were assumed to be positioned on a wall 10 cm away from the TV set as depicted in Fig. E2a. The curtains were characterised as thermally thin materials.

References

- Karlsson, B. and Quintiere, J. G. 2000. *Enclosure Fire Dynamics*. Boca Raton: CRC Press LLC. 315 p. ISBN 0 8493-1300-7
- McGrattan, K. B., Baum, H. R., Rehm, R. G., Hamins, A. and Forney, G. P. 2000. *Fire Dynamics Simulator - Technical Reference Guide*. Gaithersburg: National Institute of Standards and Technology. (NISTIR 6467)
- McGrattan, K. B. and Forney, G. P. 2000. *Fire Dynamics Simulator–Users Guide*. Gaithersburg: National Institute of Standards and Technology. (NISTIR 6469)
- Troitsch, J. H. 1999. *Flammability and Fire Behaviour of TV Sets*. Kokouesitys: Sixth International Symposium of Fire Safety Science, 5–9 July, 1999 in Poitiers, France. 15 p.
- Wetterlund, I. and Göranson, U. 1988. *A Full Scale Fire Test Method for Free-Hanging Curtain and Drapery Textiles*. Borås: Swedish National testing Institute. (SP Report 1988:45).
- Zukoski, E. E. 1978. *Development of a Stratified Ceiling Layer in the Early Stages of a Closed Room Fire*. *Fire and Materials*, vol. 2, no. 2. Pp. 54-62.



Author(s) Hietaniemi, Jukka, Mangs, Johan & Hakkarainen, Tuula			
Title Burning of Electrical Household Appliances An Experimental Study			
Abstract <p>Burning characteristics of electrical household appliances of four different types, TV sets, washing machines, dishwashers and refrigerator-freezers, have been studied experimentally. Results obtained comprise rate of heat release, mass loss and generation of smoke and some chemical substances as well as the quantities derived from these data such as the effective heat of combustion. The experiments are comprehensively documented by written records of events and photographs.</p> <p>High intensities of burning were detected. The highest rates of heat release (RHR), up to 2000 kW, were found for refrigerator-freezers. The peak RHR values for the other apparatuses were: dishwashers 350–750 kW, washing machines 300–450 kW and TVs 250–300 kW. Generally, the development of the burning of the apparatuses towards full burning has two phases. The first phase involves low-RHR incipient burning and during the second phase RHR grows rapidly towards the peak values. TV set fires develop rapidly: the first phase lasts ca. 1.5–3 minutes and, after it, the peak RHR value may be reached within 1–1.5 minutes from the initiation of the rapid RHR growth. For washing machines the period of incipient burning was rather long, 10–20 minutes depending on the way the apparatus was ignited (ignition in the motor space or at the control panel). For the dishwashers the delay was 5–10 minutes. A similar delay was found also in three refrigerator-freezer experiments. In one refrigerator-freezer experiment, the delay time was clearly shorter, only 2–3 minutes.</p> <p>A computational analysis of the development of room fires originating from ignited electrical household appliances was conducted to study the significance of the measured burning characteristics. The RHR of refrigerator-freezers is so high that fires originating from these apparatuses probably lead to flashover. In the case of dishwasher fires, the likelihood of flashover is considerable. The probability of flashover TV set fires in relatively large spaces (such as living rooms) depends mainly on the probability of ignition of other items in the room. In small rooms, e.g., children's bedrooms, the TV fires are considerably more dangerous than in larger rooms. In the case of washing machine fires, the development of the fire is in practice usually governed by the availability of oxygen since the rooms with washing machines mainly have closed openings.</p> <p>Smoke production was high especially for TV sets. Thus, smoke damages are likely to be considerable in fires involving electrical household appliances.</p>			
Keywords combustion, fire tests, fire safety, electric equipment, electric devices, households appliances, smoke, heat loss, ignition, TV, washing machines, dishwashers, refrigerators			
Activity unit VTT Building and Transport, Building Physics, Building Services and Fire Technology, Kivimiehentie 4, P.O.Box 1803, FIN-02044 VTT, Finland			
ISBN 951-38-5802-2 (soft back ed.) 951-38-5803-0 (URL: http://www.inf.vtt.fi/pdf/)		Project number ROSU00333	
Date March 2001	Language English	Pages 60 p. + app. 23 p.	Hinta B
Name of project		Commissioned by The Safety Technology Authority (TUKES)	
Series title and ISSN VTT Tiedotteita – Meddelanden – Research Notes 1235-0605 (soft back ed.) 1455-0865 (URL: http://www.inf.vtt.fi/pdf/)		Sold by VTT Information Service P.O.Box 2000, FIN-02044 VTT, Finland Phone internat. +358 9 456 4404 Fax +358 9 456 4374	