

SAFIR

The Finnish Research Programme on Nuclear Power Plant Safety 2003- 2006

Final Report

SAFIR
The Finnish Research
Programme on Nuclear Power
Plant Safety 2003–2006
Final Report

Edited by

Hanna Räty & Eija Karita Puska

ISBN 951-38-6886-9 (soft back ed.)

ISSN 1235-0605 (soft back ed.)

ISBN 951-38-6887-7 (URL: <http://www.vtt.fi/publications/index.jsp>)

ISSN 1455-0865 (URL: <http://www.vtt.fi/publications/index.jsp>)

Copyright © VTT 2006

JULKAISIJA – UTGIVARE – PUBLISHER

VTT, Vuorimiehentie 3, PL 1000, 02044 VTT

puh. vaihde 020 722 111, faksi 020 722 4374

VTT, Bergsmansvägen 3, PB 1000, 02044 VTT

tel. växel 020 722 111, fax 020 722 4374

VTT Technical Research Centre of Finland, Vuorimiehentie 3, P.O. Box 1000, FI-02044 VTT, Finland

phone internat. +358 20 722 111, fax +358 20 722 4374

VTT, Lämpömiehenkuja 3 A, PL 1000, 02044 VTT

puh. vaihde 020 722 111, faksi 020 722 5000

VTT, Värmemansgränden 3 A, PB 1000, 02044 VTT

tel. växel 020 722 111, fax 020 722 5000

VTT Technical Research Centre of Finland

Lämpömiehenkuja 3 A, P.O. Box 1000, FI-02044 VTT, Finland

phone internat. + 358 20 722 111, fax + 358 20 722 5000

Text preparing Tarja Haapalainen

Edita Prima Oy, Helsinki 2006

SAFIR. The Finnish Research Programme on Nuclear Power Plant Safety 2003–2006. Final Report. Ed. by Hanna Rätty & Eija Karita Puska. Espoo 2006. VTT Tiedotteita – Research Notes 2363. 379 p. + app. 98 p.

Keywords nuclear safety, reactor components, reactor core, fuel elements, high-burnup, thermal hydraulics, severe accidents, containment, reactor circuit, structural safety, control rooms, automation, organisations, risk informed safety management, ageing, reactor analysis

Abstract

Major part of Finnish public research on nuclear power plant safety during the years 2003–2006 has been carried out in the SAFIR programme. The programme has been administrated by the steering group that was nominated by the Ministry of Trade and Industry (KTM). The steering group of SAFIR has consisted of representatives from Radiation and Nuclear Safety Authority (STUK), Ministry of Trade and Industry (KTM), Technical Research Centre of Finland (VTT), Teollisuuden Voima Oy (TVO), Fortum Power and Heat Oy, Fortum Nuclear Services Oy (Fortum), Finnish Funding Agency for Technology and Innovation (Tekes), Helsinki University of Technology and Lappeenranta University of Technology.

The key research areas of SAFIR have been 1) reactor fuel and core, 2) reactor circuit and structural safety, 3) containment and process safety functions, that was divided in 2005 into 3a) thermal hydraulics and 3b) severe accidents, 4) automation, control room and IT, 5) organisations and safety management and 6) risk-informed safety management. The research programme has included annually from 20 up to 24 research projects, whose volume has varied from a few person months to several person years. The total volume of the programme during the four year period 2003–2006 is 19.7 million euros and 148 person years.

The research in the programme has been carried out primarily by the Technical Research Centre of Finland (VTT). Other research units responsible for the projects include Lappeenranta University of Technology, Fortum Nuclear Services Oy, Helsinki University of Technology and RAMSE Consulting Oy. In addition, there have been a few minor subcontractors in some projects.

The programme management structure has consisted of the steering group, a reference group in each of the seven research areas and a number of ad hoc groups in the various research areas.

This report gives a summary of the results of the SAFIR programme for the period January 2003 – November 2006.

Preface

SAFIR, The Finnish Research Programme on Nuclear Power Plant Safety 2003–2006 has continued the tradition of Finnish national research programmes in nuclear area. Organisation of public nuclear energy research in Finland as national research programmes was started in 1989 by the Ministry of Trade and Industry (KTM). Since then national programmes have been carried out in the fields of operational aspects of safety (YKÄ 1990–1994, RETU 1995–1998), structural safety (RATU 1990–1994, RATU2 1995–1998), and in FINNUS 1999–2002 that was the first programme that combined the operational aspects and structural safety. Simultaneously the research was carried out in nuclear waste management programmes (JYT 1989–1993, JYT2 1994–1996, JYT2001 1997–2001, KYT 2002–2005). The research themes of SAFIR will continue in the following research programme SAFIR2010 during the years 2007–2010.

In parallel with the public programmes research has been carried out in the Finnish Fusion Research Programmes (FFUSION and FFUSION2) 1993–2002, programmes on Advanced Light Water Reactor concepts (ALWR) 1998–2003 and a project on component life management 1999–2003, partly funded by the Finnish Funding Agency for Technology and Innovation (Tekes). Currently fusion research continues in the FUSION (2003–2006) and nuclear waste management research in the KYT2010 (2006–2010) programme.

The steering group of SAFIR consists of representatives from Radiation and Nuclear Safety Authority (STUK), Ministry of Trade and Industry (KTM), Technical Research Centre of Finland (VTT), Teollisuuden Voima Oy (TVO), Fortum Power and Heat Oy, Fortum Nuclear Services Oy (Fortum), Finnish Funding Agency for Technology and Innovation (Tekes), Helsinki University of Technology and Lappeenranta University of Technology.

At the beginning of 2004 there was a major change in the funding structure of the programme in comparison with the year 2003 due to a change in the Finnish legislation on nuclear energy. The funding by KTM, STUK, TVO and Fortum was replaced by funding from a separate fund of the State Nuclear Waste Management Fund (VYR). This VYR-funding is collected from the Finnish utilities Fortum and TVO with respect of their MWth shares in Finnish nuclear power plants. The main funding sources of the programme in 2004–2006 have been the State Nuclear Waste Management Fund (VYR) with 2.7 M€ and Technical Research Centre of Finland (VTT) with 1.3–1.5 M€ annually.

The key research areas of SAFIR are 1) reactor fuel and core, 2) reactor circuit and structural safety, 3) containment and process safety functions, that was divided in 2005

into 3a) thermal hydraulics and 3b) severe accidents, 4) automation, control room and IT, 5) organisations and safety management and 6) risk-informed safety management.

SAFIR has been a relatively dynamic research programme allowing inclusion of new projects or extension of the existing projects during the research year. Besides the research done within SAFIR and education of experts via this research, SAFIR has been an important national forum of information exchange for all parties involved.

This report has been prepared by the programme management in cooperation with the project managers and project staff.

More information on SAFIR:

<http://www.vtt.fi/safir>

<http://www.vtt.fi/safir2010>.

Contents

Abstract.....	3
Preface.....	4
1. Introduction.....	11
1.1 The role of SAFIR research programme	11
1.2 Statistical information.....	16
1.3 Administration, seminars and international evaluation	24
1.4 Structure of the report.....	26
1.5 Acknowledgements.....	26
2. Enhanced methods for reactor analysis (EMERALD)	28
2.1 EMERALD summary report.....	28
2.2 Development of Monte Carlo neutron transport methods for reactor physics applications.....	41
2.3 The coupled code TRAB-3D-SMABRE for 3D transient and accident analyses.....	48
3. High-burnup upgrades in fuel behaviour modelling (KORU).....	60
3.1 KORU summary report.....	60
3.2 Improvements in transient fuel performance modelling.....	69
4. Integrity and life time of reactor circuits (INTELI).....	79
4.1 INTELI summary report.....	79
4.2 Development and application of risk informed in-service inspection analysis procedures.....	92
4.3 Completion of the new surveillance programme for Loviisa 1.....	103
4.4 Applicability of small specimen test results.....	110
5. LWR oxide model for improved understanding of activity build-up and corrosion phenomena (LWROXI)	115
5.1 Further development of the Mixed-Conduction Model of oxide films in LWRs emphasising surface complexation and reprecipitation.....	115
6. Ageing of the Function of the Containment Building (AGCONT, 2003–2004) / Participation in the OECD NEA Task Group Concrete Ageing (CONAGE, 2003) / Safety Management of Concrete Structures in Nuclear Power Plants (CONSAFE, 2005)	127
6.1 Durability and Safety of Concrete Structures in Nuclear Power Plants	127

7.	Concrete technological studies related to the construction, inspection and reparation of the nuclear power plant structures (CONTECH)	132
7.1	CONTECH summary report.....	132
7.2	Very rapid hardening mortars, grouts and concretes.....	133
8.	The integration of thermal hydraulics (CFD) and finite element (FEM) computer codes in liquid and solid mechanics (MULTIPHYSICS)	136
9.	The Integral Code for Design Basis Accident Analyses (TIFANY, 2003) / APROS modelling of containment pressure suppression systems (TIFANY, 2004) / Development of APROS containment model (TIFANY, 2005) / Validation of APROS containment model (TIFANY, 2006)	146
9.1	TIFANY summary report.....	146
10.	Thermal hydraulic analysis of nuclear reactors (THEA)	156
10.1	THEA summary report.....	156
10.2	Simulation of condensation on MISTRA facility using Fluent code.....	166
11.	Archiving experiment data (KOETAR)	173
12.	Condensation pool experiments (POOLEX).....	179
12.1	POOLEX summary report.....	179
12.2	Combined effects experiments with the condensation pool test facility (POOLEX).....	191
13.	PACTEL OECD project planning (PACO)	199
14.	Participation in Development of European Calculation Environment (ECE)	202
15.	Wall response to soft impact (WARSI) & Impact loaded structures (IMPACT)	207
15.1	Experimental and Numerical Studies on Impacts.....	207
16.	Severe accidents and nuclear containment integrity (SANCY, 2003–2005) / Cavity phenomena and hydrogen burns (CAPHORN, 2006).....	225
16.1	SANCY / CAPHORN summary report.....	225
16.2	Modeling of the FLAME hydrogen combustion tests F-8 and F-22 using TONUS CFD code.....	237
17.	Fission product gas and aerosol particle control (FIKSU, 2003–2004) / Behaviour of fission products in air-atmosphere (FIKA, 2005–2006).....	246
17.1	FIKSU-FIKA summary report.....	246
17.2	Experiments on the behaviour of ruthenium in air ingress accidents.....	253

18. Development of aerosol models for NPP applications (AMY)	263
19. Emergency preparedness supporting studies (OTUS).....	273
19.1 OTUS summary report	273
20. Interaction approach to development of control rooms (IDEC).....	275
20.1 Integrated validation of complex human-technology systems – development of a new method	275
21. Application possibilities of systematic requirements management in the improvement of nuclear safety in Finland (APSREM).....	286
21.1 APSREM Summary Report.....	286
22. Influence of RoHS-directive to reliability of electronics – preproject (ROVEL)....	288
22.1 ROVEL summary report	288
23. Software qualification – error types and error management in software life-cycles (QETES)	290
24. Influence of Whiskers to Reliability of Electronics, Prestudy (WHISKE).....	300
24.1 WHISKE summary report.....	300
25. Organisational culture and management of change (CULMA).....	305
25.1 CULMA summary report	305
25.2 Organizational factors, management, and nuclear safety.....	314
26. Disseminating Tacit Knowledge and Expertise in Nuclear Power Plants (TIMANTTI).....	323
26.1 Tacit Knowledge and Preserving It in Nuclear Power Plants.....	323
27. Potential of fire spread (POTFIS).....	335
27.1 POTFIS summary report	335
27.2 Two-Model Monte Carlo Simulation of Fire Scenarios.....	343
28. Principles and practices of risk-informed safety management (PPRISMA).....	353
28.1 PPRISMA summary report.....	353
28.2 Interdisciplinary development of risk-informed management of fire situations.....	361
29. Assessment of smart device software (ASDES).....	371
29.1 Assessment of smart device software.....	371

Appendices

Appendix A: Publications of the projects

Appendix B: Finnish members in international committees and working groups in 2006

Appendix C: Academic degrees awarded in the projects 1.1.2003–30.11.2006

Appendix D: The steering group, the reference groups and the scientific staff of the projects

1. Introduction

1.1 The role of SAFIR research programme

SAFIR, The Finnish Research Programme on Nuclear Power Plant Safety 2003–2006 has continued the tradition of Finnish national research programmes in nuclear area.

The programme has been administrated by the steering group that was nominated by the Ministry of Trade and Industry (KTM). The steering group of SAFIR has consisted of representatives from Radiation and Nuclear Safety Authority (STUK), Ministry of Trade and Industry (KTM), Technical Research Centre of Finland (VTT), Teollisuuden Voima Oy (TVO), Fortum Power and Heat Oy, Fortum Nuclear Services Oy (Fortum), Finnish Funding Agency for Technology and Innovation (Tekes), Helsinki University of Technology (TKK) and Lappeenranta University of Technology (LTY). The major partners of SAFIR are shown in Figure 1.



Figure 1. All the key players of the Finnish nuclear field have been represented in the SAFIR steering group.

The role of public nuclear safety research is to provide the necessary conditions for retaining the knowledge that is needed to ensure the continuance of safe and economic use of nuclear power, development of new know-how and participation in international co-operation.

Nuclear safety research in Finland consists of three components: regulatory research, utility research and public research. The roles of these can be illustrated with the ‘football field’ example in Figure 2. Regulatory research and utility research whose total annual volume exceeds the volume of public research are strictly separated from the public research programme.

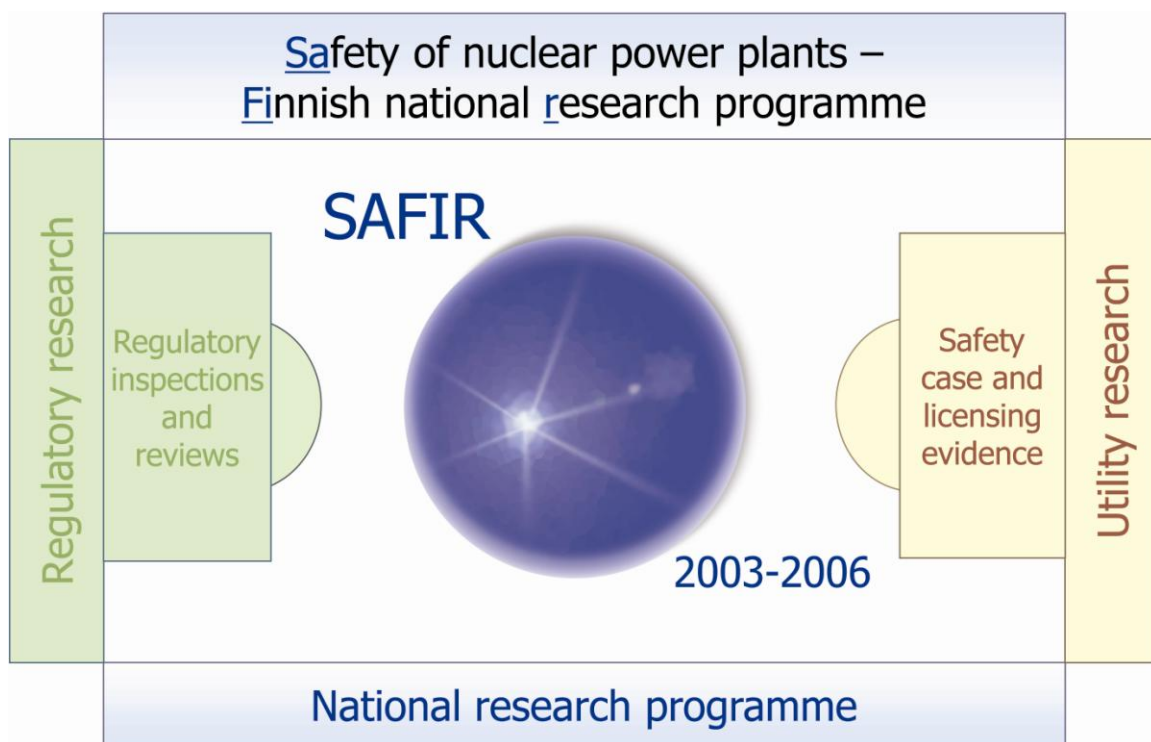

Figure 2. The roles of public, regulatory and utility research in Finland.

Framework plan [1] of SAFIR was made for the period 2003–2006, but it was based on safety challenges identified for a longer time span as well. In the framework plan it was recognized that the safety challenges set by the existing plants and the new plant unit, as well as the ensuing research needs do converge to a great extent. The framework plan defined the important research needs related to the safety challenges, such as the ageing of the existing plants, technical reforms in the various areas of technology and organisational changes. The research that fulfills these needs has been the programme’s main techno-scientific task. In addition, the programme had to ensure the maintenance of know-how in the nuclear specific research areas where dynamic research activities are the absolute precondition for safe use of nuclear power.

The SAFIR 2003–2006 programme has taken advantage of the results obtained and lessons learned in the former national research programmes. The programmes in the area of nuclear safety (YKÄ & RATU 1990–1994, RETU&RATU2 1995–1998, FINNUS 1999–2002 and SAFIR 2003–2006) have had the total volume of 75 M€ and 689 person years. According to the final reports of the successive programmes they have produced 2434 publications in various categories and 25 Doctor, 17 Licentiate and 61 Master level academic degrees. The extent of the various programmes is given in Table 1. The Finnish public nuclear safety research will continue in the SAFIR2010 programme during the years 2007–2010.

Table 1. Finnish public research programmes on reactor safety 1990–2006.

Programme	Volume, M€	Volume, person years	Total number of publications	Academic degrees		
				Dr.	Lic.	M.Sc.
YKÄ 1990–1994	15,4	168	318	6	5	10
RATU 1990–1994	8,2	76	322	1	3	3
RETU 1995–1998	9,8	107	405	3	2	2
RATU2 1995–1998	7,5	60	280	3	4	11
FINNUS 1999–2002	14,4	130	564	6	2	18
SAFIR 2003–2006	19,7	148	545	6	1	17

Research areas and projects in SAFIR programme

The key research areas of SAFIR have been 1) reactor fuel and core, 2) reactor circuit and structural safety, 3) containment and process safety functions, that was divided in 2005 into 3a) thermal hydraulics and 3b) severe accidents, 4) automation, control room and IT, 5) organisations and safety management and 6) risk-informed safety management.

Reactor fuel and core area covers reactor physics, reactor dynamics and fuel behaviour analysis. The research is done solely with the help of calculational tools, partly with sophisticated tools developed at VTT and partly using tools developed elsewhere. The projects in this area have active contacts with international theoretical and experimental work, such as the OECD Halden Reactor Project, the OECD-IRSN CABRI Project and several other international research projects and working groups.

One of the main goals of the SAFIR programme is the education of the new generation. In this most ‘nuclear-specific’ research area of SAFIR, this task is particularly pronounced. All SAFIR research areas have links both between the various projects in the area and to neighbouring research areas.

During the entire programme there have been two research projects in reactor fuel and core area, the Enhanced methods for reactor analysis (EMERALD) project dealing with reactor physics and dynamics and the High-burnup upgrades in fuel behaviour modelling (KORU) project dealing with the fuel research.

Reactor circuit and structural safety area covers the studies on the integrity and life time of the entire reactor circuit and the studies of containment building construction, inspection, ageing and repairing. In this area the projects include both experimental and theoretical studies. The projects in this area have also active contacts with international research work, both in EU and elsewhere.

During the programme there have been altogether six research projects in this area. The Integrity and life time of reactor circuits (INTELI) project is a very large one and has extended over the whole time span of the programme. The main objective is to assure the structural integrity of the main components of the reactor circuit of the nuclear power plant and to study the typical ageing mechanisms affecting the integrity of main components during the life-time of the reactor. The main components included in the scope of the project are reactor pressure vessel with nozzles and internals, piping of reactor circuit and other components (steam generators, pumps, valves, pressurizer and heat exchangers). Oxide modelling is studied in the LWR oxide model for improved understanding of activity build-up and corrosion phenomena (LWROXI) project that started in 2004. Containment issues have been studied in a number of projects: Ageing of the Function of the Containment Building (AGCONT, 2003–2004), Participation in the OECD NEA Task Group Concrete Ageing (CONAGE, 2003), Safety Management of Concrete Structures in Nuclear Power Plants (CONSAFE, 2005) and Concrete technological studies related to the construction, inspection and reparation of the nuclear power plant structures (CONTECH) that has continued over the entire programme.

Thermal hydraulics research area covers simulation of nuclear power plant processes, calculational thermal hydraulics and multiphysics approaches using several codes, experimental thermal hydraulics at Lappeenranta University of Technology (LUT). Multiphysical approaches, strong coupling of experimental and theoretical work and active follow-up and participation in international research programmes are characteristic to the projects in this research area. In this field, with several very ‘nuclear-specific’ projects, fostering of a new generation of experts has a vital role, too.

The projects in this area include The integration of thermal hydraulics (CFD) and finite element (FEM) computer codes in liquid and solid mechanics (MULTIPHYSICS), The Integral code for design basis accident analyses (TIFANY, 2003), APROS modelling of containment pressure suppression systems (TIFANY, 2004), Development of APROS containment model (TIFANY, 2005), Validation of APROS containment model

(TIFANY, 2006), Thermal hydraulic analysis of nuclear reactors (THEA), Archiving experiment data (KOETAR) and Condensation pool experiments (POOLEX), that have all continued during the entire programme. In addition there have been two smaller projects, the PACTEL OECD project planning (PACO, 2004) and Participation in Development of European Calculation Environment (ECE, 2005–2006).

Severe accidents research area has included tightly coupled calculational and experimental projects on aircraft crash studies: Wall response to soft impact (WARSI) that was started in 2003 and Impact loaded structures (IMPACT, 2004–2006). Projects considering the more ‘traditional’ issues of severe accidents have included Severe accidents and nuclear containment integrity (SANCY, 2003–2005), Cavity phenomena and hydrogen burns (CAPHORN, 2006), Fission product gas and aerosol particle control (FIKSU, 2003–2004), Behaviour of fission products in air-atmosphere (FIKA, 2005–2006), Development of aerosol models for NPP applications (AMY, 2003–2004) and Emergency preparedness supporting studies (OTUS, 2003).

The research in SAFIR in the areas automation, control room and IT, organisations and safety management and risk informed safety management concentrates on the nuclear-specific problems. A typical feature of all these research areas is that the majority of total research activities both in Finland and abroad are directed to non-nuclear applications and that same tools and methods can be used quite extensively both in nuclear and in non-nuclear research problems.

Automation, control room and IT research area has focused on the new technologies that are emerging at nuclear power plants both via new plants and via renewal of automation and control rooms in the existing plants.

The research projects in this area have contained the Interaction approach to development of control rooms (IDEC) project that has continued over the whole programme and a number of smaller projects with shorter duration including: Application possibilities of systematic requirements management in the improvement of nuclear safety in Finland (APSREM, 2003), Influence of RoHS-directive to reliability of electronics – preproject (ROVEL, 2004), Software qualification – error types and error management in software life-cycles (QETES, 2005–2006) and Influence of Whiskers to Reliability of Electronics, Prestudy (WHISKE, 2005).

Organisations and safety management research area focuses on the organisational culture and management of change and on the tacit knowledge involved. The expertise of this research area is used also in the neighbouring areas in questions related to control rooms and automation and in research related too fires at NPPs.

The research has been carried out in two projects: Organisational culture and management of change (CULMA) that has continued over the whole programme and Disseminating tacit knowledge in organisations (TIMANTTI, 2004–2006). Similarly to other research areas, the projects involved also participation in international research and working groups.

Risk-informed safety management means use of information from probabilistic safety assessment (PSA) to support decision making in various contexts. The expertise on risk-informed safety assessment methods are used also in some projects in other research areas in SAFIR.

The research area has included two projects, that have continued over the entire programme: Potential of Fire Spread (POTFIS) and The Principles and Practices of Risk-Informed Safety Management (PPRISMA). The third project in the area is Assessment of smart device software (ASDES, 2005–2006) that has strong links to the automation research area.

1.2 Statistical information

The research programme has included annually from 20 up to 24 research projects, whose volume has varied from a few person months to several person years. The total volume of the programme during the four year period 2003–2006 is 19.7 million euros and 148 person years. The research projects and administration (SAHA) have been collected in Table 2. The research has been carried out primarily by the Technical Research Centre of Finland (VTT). Other research units responsible for the projects include Lappeenranta University of Technology, Fortum Nuclear Services Oy, Helsinki University of Technology and RAMSE Consulting. In addition, there have been a few minor subcontractors in some projects.

Table 2. The research projects of SAFIR in 2003–2006.

Group	Project and principal research organisation	Acronym	Funding (thousand Euro)				Volume (person-years)				Total
			2003	2004	2005	2006	2003	2004	2005	2006	
1.						plan	y	y	y	y	
	Enhanced methods for reactor analysis <i>VTT</i>	EMERALD	487	572,9	568,1	583	4,36	4,96	4,4	4,45	18,17
	High-burnup upgrades in fuel behaviour modelling <i>VTT</i>	KORU	220	295,7	285,5	293	2,11	3,04	2,9	2,43	10,48
2.											
	Integrity and life time of reactor circuits <i>VTT</i>	INTELI	1019	1082	1215,3	1149	7	7,60	7,4	6,99	28,99
	LWR oxide model for improved understanding of activity build-up and corrosion phenomena <i>VTT</i>	LWROXI	-	86	64,1	92	-	0,62	0,3	0,78	1,7
	Ageing of the function of the containment building <i>VTT</i>	AGCONT	13	34	-	-	0,1	-	-	-	0,1
	Participation in the OECD NEA task group concrete ageing <i>VTT</i>	CONAGE	9,5	-	-	-	0,07	-	-	-	0,07
	Safety Management of Concrete Structures in Nuclear Power Plants <i>VTT</i>	CONSAFE	-	-	17,5	-	-	-	0,1	-	0,1
	Concrete technological studies related to the construction, inspection and reparation of the nuclear power plant structures <i>VTT</i>	CONTECH	100,5	107,5	144,6	9,2	0,7	0,85	1,3	0,88	3,73
3.											
a	The integration of thermal hydraulics (CFD) and finite element (FEM) computer codes in liquid and solid mechanics <i>Fortum Nuclear Services</i>	MULTI-PHYSICS	-	117	154	98	-	0,69	1,2	1,05	2,94
a	The integral code for design basis accident analyses <i>Fortum Nuclear Services</i>	TIFANY	203,3	209,6	194,3	116,8	1,53	1,73	1,4	1,00	5,66

a	Thermal hydraulic analysis of nuclear reactors <i>VTT</i>	THEA	165,8	165	206,3	259	1	0,95	1,4	2,00	5,35
a	Archiving experiment data <i>Lappeenranta University of Technology</i>	KOETAR	60	60,6	50,3	40	0,6	0,60	0,5	0,38	2,08
a	Condensation pool experiments <i>Lappeenranta University of Technology</i>	POOLEX	163,9	258,5	271,3	292	2	2,90	3,4	2,10	10,4
	PACTEL OECD project planning <i>Lappeenranta University of Technology</i>	PACO	-	80,3	-	-	-	0,19	-	-	0,19
a	Participation in development of European calculation environment <i>Lappeenranta University of Technology</i>	ECE	-	-	53,2	50	-	-	0,7	0,67	1,37
b	Wall response to soft impact <i>VTT</i>	WARSI	138,4	140,8	152,6	170,5	1,2	1,24	0,7	1,00	4,14
b	Impact tests <i>VTT</i>	IMPACT	-	221,5	153,0	220	-	1,50	1,1	1,52	4,12
b	Severe accidents and nuclear containment integrity <i>VTT</i>	SANCY	314	306	305,6	-	1,56	1,70	2,8	-	6,06
b	Cavity phenomena and hydrogen burns <i>VTT</i>	CAPHORN	-	-	-	320,25	-	-	-	2,00	2
	Fission product gas and aerosol particle control <i>VTT</i>	FIKSU	112	56,1	-	-	1	0,50	-	-	1,5
b	Behaviour of fission products in air-atmosphere <i>VTT</i>	FIKA	-	-	250,6	315	-	-	2,4	2,62	5,02
	Development of aerosol models for nuclear applications <i>Fortum Nuclear Services</i>	AMY	150	148,4	-	-	1,9	1,43	-	-	3,33
	Emergency preparedness supporting studies <i>VTT</i>	OTUS	50	-	-	-	0,41	-	-	-	0,41
4.											
	Interaction approach to development of control rooms <i>VTT</i>	IDEC	140	196	197	17,5	1,1	1,34	1,4	1,67	5,51
	Application possibilities of systematic requirements management in the improvement of nuclear safety in Finland <i>RAMSE Consulting</i>	APSREM	50	-	-	-	0,44	-	-	-	0,44

	Influence of RoHS-directive to reliability of electronics – preproject VTT	ROVEL	-	20	-	-	-	0,11	-	-	0,11
	Software qualification – error types and error management in software life-cycle VTT	QETES	-	-	74,1	74,94	-	-	0,5	0,43	0,93
	Influence of Whiskers to Reliability of Electronics, Prestudy VTT	WHISKE	-	-	24,5	-	-	-	0,1	-	0,1
5.											
	Organisational culture and management of change VTT	CULMA	201	210	178,9	184	1,45	1,52	1,6	1,43	6,00
	Disseminating tacit knowledge in organisations (preproject 04) <i>Helsinki University of Technology</i>	TIMANTTI	-	27,3	69,8	52	-	0,43	1,1	0,67	2,20
6.											
	Potential of fire spread VTT	POTFIS	158,5	158	158,0	208	0,7	1,00	1,0	1,24	3,94
	Principles and practices of risk-informed safety management VTT	PPRISMA	245	248,5	215	224,9	2,07	2,05	1,6	1,50	7,22
	Assessment smart device software VTT	ASDES	-	-	80	80	-	-	0,2	0,57	0,77
0.	SAFIR Administration and information (2002–2003) VTT	SAHA	107,9	125,1	112,6	194,73	0,81	0,75	0,5	0,95	3,01
	Total		4108,76	5058,0	5197,6	5360,6	32,11	37,96	40,0	38,31	148,38

Distribution of total funding in the SAFIR research areas in 2003–2006 is shown in Figure 3. At the beginning of 2004 there was a major change in the funding structure of the programme in comparison with the year 2003 due to a change in the Finnish legislation on nuclear energy. The funding by KTM, STUK, TVO and Fortum was replaced by funding from a separate fund of the State Nuclear Waste Management Fund (VYR). This VYR-funding is collected from the Finnish utilities Fortum and TVO with respect of their MWth shares in Finnish nuclear power plants. The main funding sources of the programme in 2004–2006 have been the State Nuclear Waste Management Fund (VYR) with 2.7 M€ and Technical Research Centre of Finland (VTT) with 1.3–1.5 M€ annually. Two projects have obtained funding from Tekes instead of the VYR-funding. The distribution of the VYR-funding to the various research areas is shown in Figure 4. Distribution of funding and person years in the seven research areas of SAFIR in 2006 have been illustrated in Figure 5 and Figure 6, respectively.

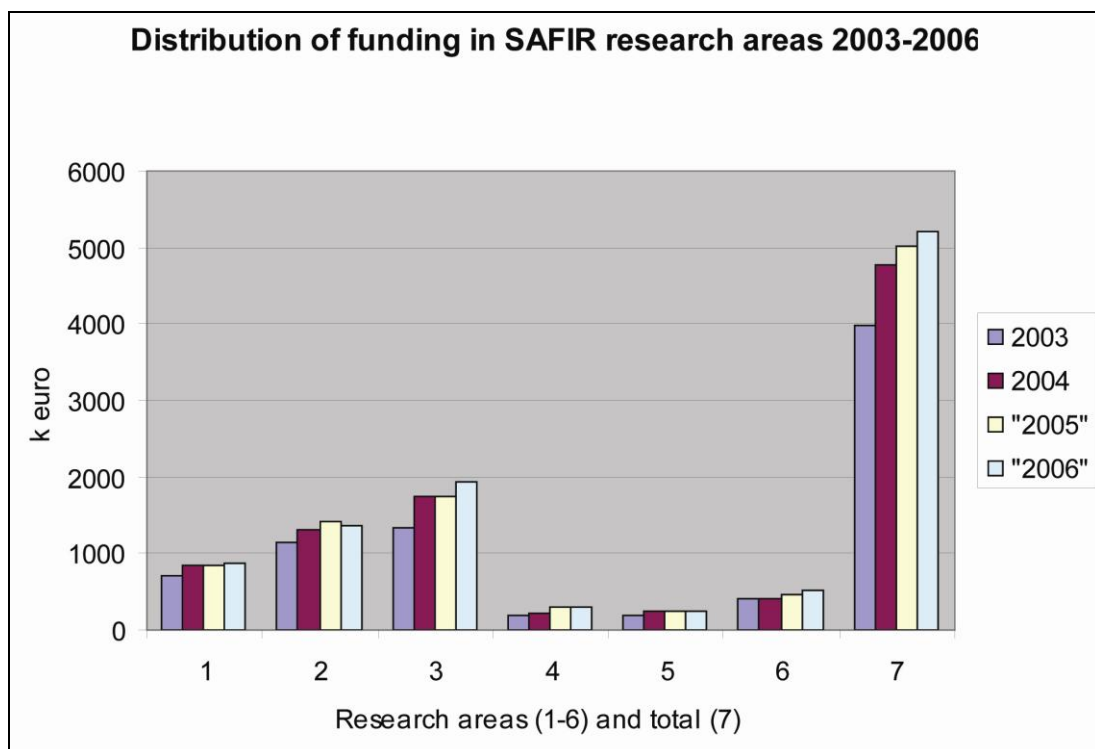

Figure 3. Distribution of total funding in the SAFIR research areas in 2003–2006.

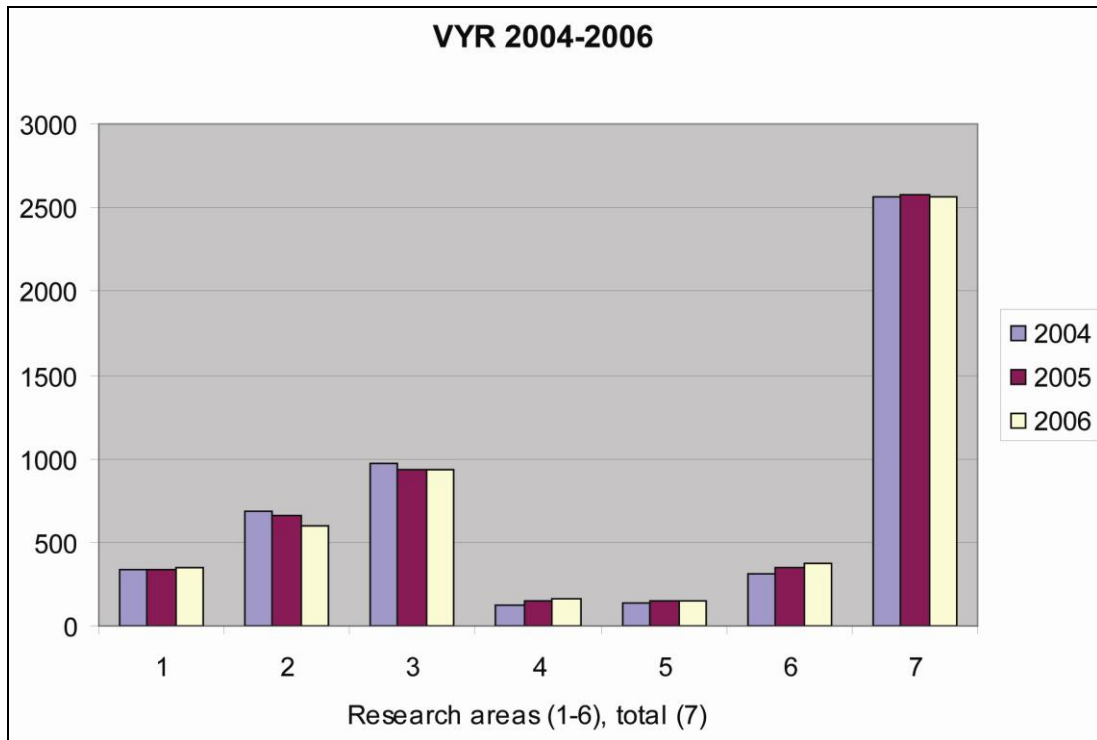

Figure 4. Distribution of VYR funding in the SAFIR research areas in 2004–2006.

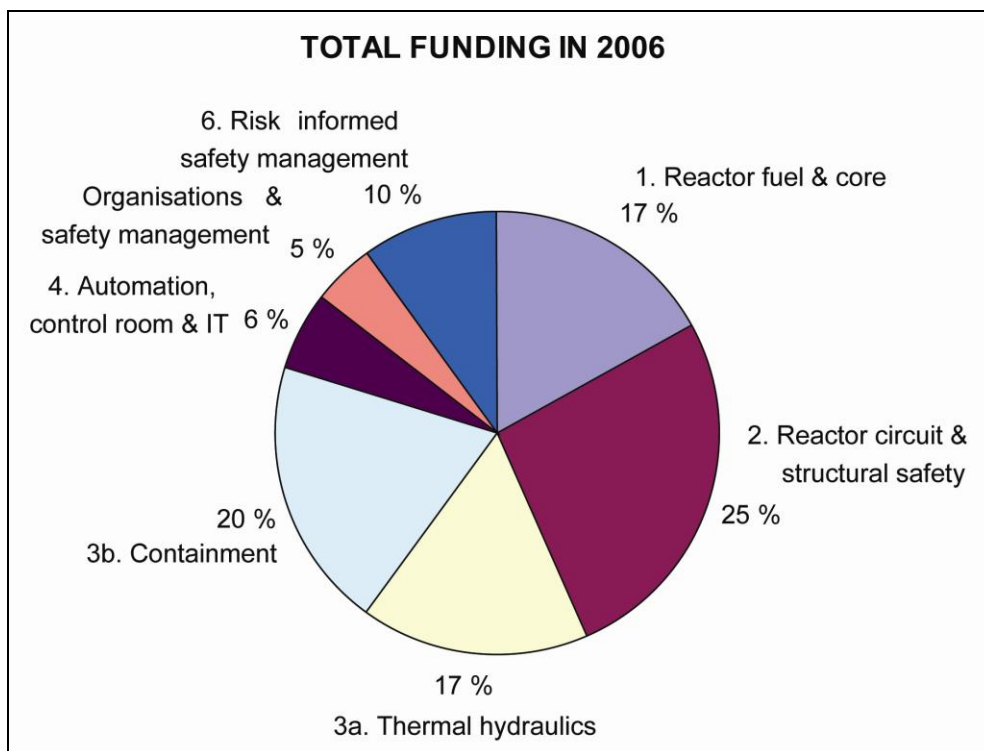

Figure 5. Distribution of funding in the SAFIR research areas in 2006.

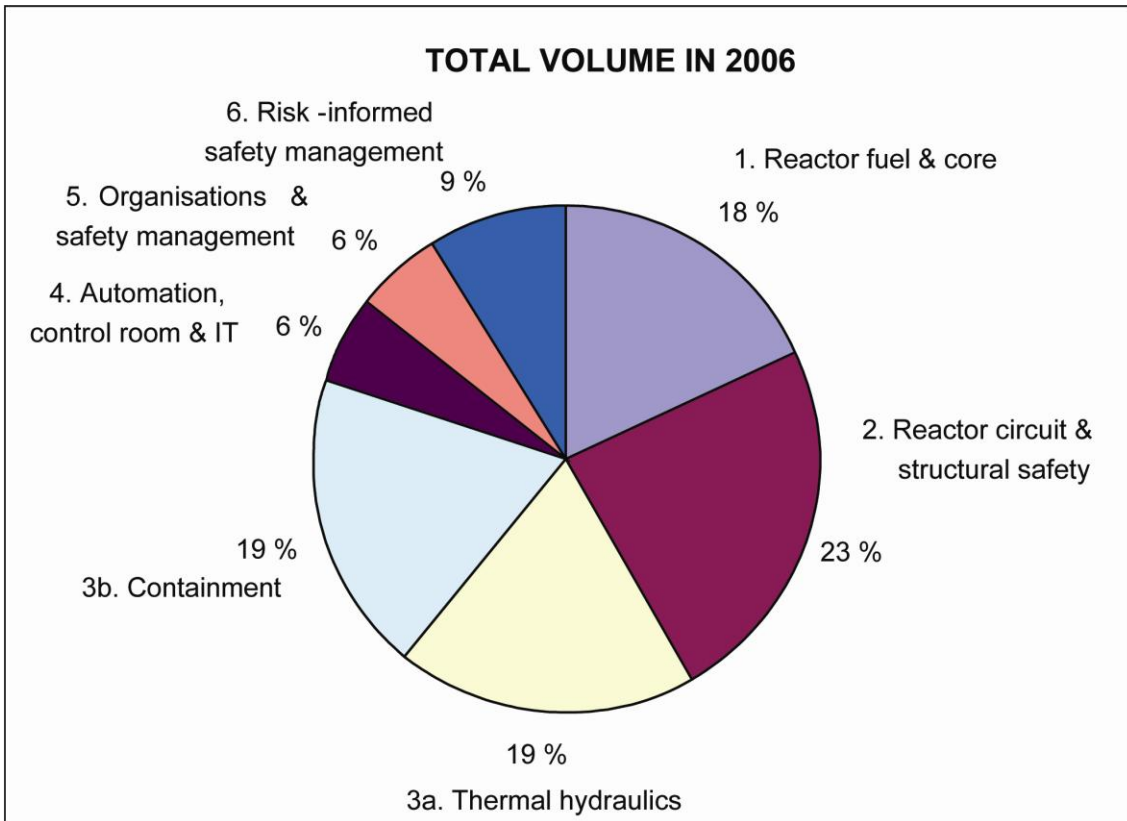

Figure 6. Distribution of person years in the SAFIR research areas in 2006.

The programme has produced 545 publications in 2003–2006. Major part of the publications consisted of conference papers and extensive research institute reports. The number of scientific publications as well as the total number of publications varied greatly between the projects, as indicated in Table 3. The average number of publications is 3,7 per person year, and the average number of scientific publications is 0,3 per person year. Some projects have deliberately aimed at publication of the results as extensive research institute reports that are found to be more useful to the end-users than scientific publications, which has to be taken into account when judging the numbers of publications in different categories.

Table 3. Publications in the SAFIR projects in 2003–2006.

Project	Scientific	Conference papers	Res. inst. reports	Others	Total	Volume pers. year
EMERALD	7	37	21	3	68	18,17
KORU	0	4	9	3	16	10,48
INTELI	15	37	34	0	86	28,99
LWROXI	1	3	2	0	6	1,70
AGCONT	0	0	3	0	3	0,1
CONAGE	0	0	0	0	0	0,07
CONSAFE	0	0	0	0	0	0,10
CONTECH	0	1	17	5	23	3,73
MULTIP	0	3	2	3	8	2,94
TIFANY	0	1	25	0	26	5,66
THEA	1	6	6	3	16	5,35
KOETAR	0	1	3	1	5	2,08
POOLEX	0	2	8	6	16	10,40
PACO	0	0	2	0	2	0,19
ECE	0	0	0	4	4	1,37
WARSI/IMPACT	0	4	8	1	13	8,26
SANCY/CAPHORN	1	4	17	1	23	8,06
FIKSU/FIKA	3	15	10	1	29	6,52
AMY	0	2	6	3	11	3,33
OTUS	0	0	3	0	3	0,41
IDEC	5	14	7	1	27	5,51
APSREM	0	0	2	0	2	0,44
ROVEL	0	0	2	0	2	0,11
QETES	0	0	2	1	3	0,93
WHISKE	0	2	1	2	5	0,1
CULMA	6	11	7	9	33	6,00
TIMANTTI	4	7	0	2	13	2,20
POTFIS	7	20	6	14	47	3,94
PPRISMA	1	14	23	7	45	7,22
ASDES	0	0	1	0	1	0,77
SAHA	0	0	8	1	9	3,01
TOTAL	51	188	235	71	545	148,38

The programme has produced so far 6 Doctoral degrees, 1 Licentiate degree and 17 Master's degrees, as indicated in Table 4.

Table 4. Academic degrees awarded in the projects.

Project	Doctor (DTech, PhD)	Licentiate (LicTech, LicPhil)	Master (MScTech, MSc, MA)	Total
EMERALD	1	1	1	3
KORU	-	-	1	1
INTELI	2	-	1	3
THEA	-	-	3	3
POOLEX	-	-	3	3
ECE	-	-	1	1
WARSI	-	-	1	1
SANCY	-	-	1	1
AMY	-	-	2	2
FIKA	1	-	-	1
IDEC	-	-	1	1
POTFIS	1	-	-	1
PPRISMA	1	-	2	3
Total	6	1	17	24

1.3 Administration, seminars and international evaluation

The programme management bodies, the steering group and the six, from 2005 onwards seven reference groups, have met on regular basis 3–4 times annually. The ad hoc groups that have a vital role for some projects have carried out successfully their tasks. The ad hoc groups have met upon the needs of the specific project. The most active and also most essential ad hoc group for the successful outcome of the project has been the WARSI-IMPACT ad hoc group. Figure 7 illustrates the structure of the SAFIR programme with the research projects forming the hot red core of the programme, the seven reference groups and the various ad hoc groups having the principal responsibility of scientific guidance and surveillance of the various research projects, as depicted with the yellow layer encircling the red core. The steering group, depicted as the blue layer, has administrated the entire research programme thus keeping the SAFIR ‘jewel’ together. The programme is managed by the coordination unit VTT, the programme director, the project co-ordinator and the project managers of the individual research projects.



Figure 7. The three-layer structure of SAFIR programme with projects (red), reference and ad hoc groups (yellow) and steering group (blue).

The information on the research performed in SAFIR has been communicated formally via the quarterly progress reports, the annual plans and annual reports [2–8] of the programme and the www-pages of the programme. Additional information has been given in seminars organised by various research projects. The detailed scientific results have been published as articles in scientific journals, conference papers, and separate reports. Brochure on the SAFIR programme was published in 2004. Interim Seminar of the programme was arranged in January 2005 with 118 participants and 22 scientific presentations and panel discussions, and Interim Report [9] was produced.

An independent international evaluation of the SAFIR-programme was ordered by KTM. The panel of three members carried out its evaluation by reviewing copies of relevant documents and, during a one-week period 19–24 March 2006, meeting with key individuals. The results of the panel were provided as general conclusions, responses to questions posed by KTM, challenges and recommendations and comments on specific projects in each subject area [10].

As a part of the planning process of the next research programme, a strategy seminar, SAFIR2010, was organised in April 2006 in Innopoli 2. Approximately 90 persons took part in the seminar. The new programme, SAFIR2010, starts at the beginning of January 2007 [11].

In addition to conducting the actual research according to the yearly plans, SAFIR has been an efficient way of information exchange with all organisations operating in the nuclear energy sector and as an open discussion forum for participation in international projects, allocation of resources and in planning of new projects.

1.4 Structure of the report

The report contains presentation of the main scientific achievements of the projects in Chapters 2–29 both in the format of project overviews and special technical reports. The Appendices give further statistical information on the programme. Appendix A contains the publications of the projects, Appendix B lists the international co-operation connections, Appendix C contain the list of academic degrees awarded and Appendix D list the members of the steering group, the reference groups and the scientific staff of the projects.

1.5 Acknowledgements

The results of the SAFIR programme have been produced by all those involved in the actual research projects. Their work is highly esteemed.

The contributions of project managers and project staff that form the essential contents of this report are acknowledged with gratitude.

The work of the persons in the Steering Group, Reference Groups and Ad Hoc Groups that has been carried out with the expense of their home organisations is highly appreciated.

Eija Karita Puska and Hanna Räty

References

1. Kansallinen ydinvoimalaitosten turvallisuustutkimus 2003–2006, ehdotus uuden tutkimusohjelman sisällöksi ja organisoinniksi. Kauppa- ja teollisuusministeriö. Työryhmä- ja toimikuntaraportteja 13/2002, SAFIR suunnitteluryhmä. (Nuclear Power Plant Safety Research 2003–2006, A proposal for the content and organisation of the new research programme. Ministry of Trade and Industry, Finland, Ad hoc committee reports 13/2002, SAFIR Working Group, in Finnish.)
2. Puska, E. K. SAFIR, The Finnish Research Programme on Nuclear Power Plant Safety, Annual Plan 2003. Espoo: VTT Processes Project Report PRO1/P7007/03. 26 p. + app. 102 p.
3. Puska, E. K. SAFIR, The Finnish Research Programme on Nuclear Power Plant Safety, Annual Report 2003. Espoo: VTT Processes Project Report PRO1/P7001/04. 58 p. + app. 119 p.

4. Puska, E. K. SAFIR, The Finnish Research Programme on Nuclear Power Plant Safety, Annual Plan 2004. Espoo: VTT Processes Project Report PRO1/P7002/04. 22 p. + app. 130 p.
5. Puska, E. K. SAFIR, The Finnish Research Programme on Nuclear Power Plant Safety, Annual Report 2004. Espoo: VTT Processes Project Report PRO1/P1014/05. 69 p. + app. 138 p.
6. Puska, E. K. SAFIR, The Finnish Research Programme on Nuclear Power Plant Safety, Annual Plan 2005. Espoo: VTT Processes Project Report PRO1/P1015/05. 22 p. + app. 157 p.
7. Puska, E. K. SAFIR, The Finnish Research Programme on Nuclear Power Plant Safety, Annual Report 2005. Espoo: VTT Research Report VTT-R-08877-06. 78 p. + app. 88 p.
8. Puska, E. K. SAFIR, The Finnish Research Programme on Nuclear Power Plant Safety, Annual Plan 2006. Espoo: VTT Research Report VTT-R-06393-06. 33 p. + app. 145 p.
9. Rätty, H. & Puska, E. K. (eds.). SAFIR, The Finnish Research Programme on Nuclear Power Plant Safety 2003–2006, Interim Report, VTT Research Notes 2272. VTT Processes. Espoo (2004). Pp. 273–280. ISBN 951-38-6515-0; ISSN 1235-0605, <http://virtual.vtt.fi/inf/pdf/tiedotteet/2004/T2272.pdf>.
10. Diamond, D., Rastas, A. & Schulz, H. Evaluation of the Finnish Nuclear Safety Research Program 'Safir'. Ministry of Trade and Industry, MTI Publications 33/2006. 27 p. ISBN 952-489-039-9; ISSN 1459-9376.
11. Järvinen, M.-L. et al. National Nuclear Power Plant safety Research 2007–2010, Proposal for SAFIR2010 Framework Plan. Ministry of Trade and Industry, MTI Publications 32/2006. 87 p. ISBN 952-489-037-2; ISSN 1459-9376.

2. Enhanced methods for reactor analysis (EMERALD)

2.1 EMERALD summary report

Randolph Höglund
VTT

Abstract

The purpose of the EMERALD project is to achieve a reliable computer code system for all necessary steady-state and transient reactor analyses. Development of models and codes as well as validation of the latter have included neutron cross section studies, nodal, Monte Carlo and deterministic transport methods, criticality safety calculations and the improvement of the dynamics codes to allow coolant flow reversal. Sensitivity and uncertainty analysis is applied to both stationary and dynamic problems. Several international meetings have been arranged and the results of the codes tested through benchmark calculations and other comparisons.

Introduction

VTT has created a comprehensive computer code system and striven to maintain competence for carrying out all reactor physics calculations needed in Finland including the necessary safety analyses. New fuel and reactor designs, new loading strategies, and the continuing trend towards higher fuel burnups make it necessary to further improve as well as validate the code system to be able to cope with the new challenges.

Main objectives

The main objective is to accomplish a unified, complete, up-to-date, easy-to-use, and flexible entirety consisting of both programs acquired from elsewhere and programs that are the result of own development. The code system should cover the whole range of calculations, from handling of basic nuclear data, i.e. cross section libraries, over fuel and core analyses in normal operating conditions to transient and accident studies using coherent models and methods. It should be possible to follow the whole life cycle of the nuclear fuel from a reactor physics point of view until its final disposal. The same or similar models can often be used in both the static and the dynamic calculations.

Additionally, it is of special importance in today's situation, when the use of nuclear power is increased at the same time as the present generation of nuclear experts is

gradually retiring from work, to maintain competence and train new personnel. Co-operation with the technical and other universities is necessary to make new students interested in this branch of science and thus ensure that the nuclear plants in Finland will be in the hands of competent people in the future, too. The tasks of the project have provided excellent possibilities for university students to perform work for their academic degrees.

Reactor physics

The work on reactor physics has been divided into five subprojects, which deal with nuclear cross sections, nodal methods, transport methods, criticality safety & isotope concentrations, and sensitivity & uncertainty analysis. These are not separate though, but work on a certain task often relates to two or more of the topics.

The results obtained in any reactor analysis is very much dependent on the quality of the cross section data that describe the interaction of the neutrons with the surrounding medium. Cross sections are often modified for different programs and different problems, but nevertheless originally based upon one of the existing basic cross section libraries. Comparisons between recent versions of the American ENDF/B, NEA Data Bank's (originally European) JEF/JEFF and the Japanese JENDL libraries have been performed [12, 13, 14]. For the time being, the JEFF-3.1 data library is scrutinised as a part of the NEA co-operation.

A new code PSG (from **P**robabilistic **S**cattering **G**ame) based on the Monte Carlo technique has been developed [15, 16, 17]. It can be used for calculation of multiplication constants, group constants, kinetic parameters, pin-wise power distributions, discontinuity factors and other parameters needed for nodal diffusion calculations, later on also for burnup calculations. For many applications it is considerably faster than other Monte Carlo-based programs. PSG is described in more detail in a separate article below and in a Doctor's thesis to be published in 2007.

Development of a new BWR core simulator code was started at VTT during SAFIR's predecessor FINNUS. Its name ARES was derived from the words **A**FEN **R**eactor **S**imulator, where AFEN stands for the neutronics solution method used in the program, which is based upon the Analytic Function Expansion Nodal model [18]. The simulator was further improved and tested during the initial phase of the EMERALD project and has now also been used for EPR calculations. ARES is useful when reference calculations for foreign commercial codes are needed, e.g. for finding and evaluating problem areas and safety margins. It can produce burnup distributions for transient calculations in independent safety studies and also makes it possible to test new models and ideas in reactor core analysis.

With the continuous development of more efficient computers, it has become possible to use the highly accurate, but also very time-consuming Monte Carlo method in many reactor physics problems. At VTT, the MCNP4C code has been frequently utilized, both as a separate tool and as a part of some larger system, but also for the validation of other codes. At the same time efficient optimum use of MCNP4C has been investigated, e.g. in [32].

A deterministic 3D radiation transport code MultiTrans has also been created at VTT. It is based upon the so-called tree multigrid technique for improving the mesh used in the calculation for solving a certain problem. It has been used for BNCT dose planning and photon-electron dose calculations in more traditional radiotherapy. In benchmark studies, MultiTrans has now also been successfully applied to reactor fuel and core criticality calculations [8, 9, 10]. The Belgian VENUS-2 reactor has proved useful for the test calculations (Figure 8). A Doctor's thesis on the development and validation of MultiTrans will be published in 2007.

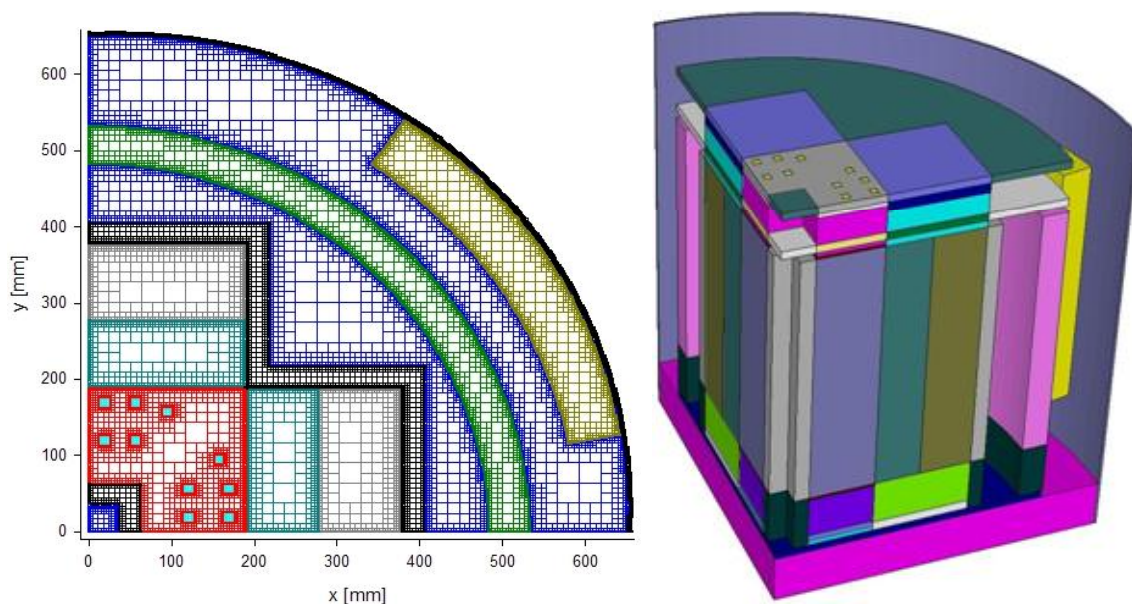

Figure 8. Modelling of the VENUS-2 reactor for benchmark calculations.

Except for the main reactor analysis codes themselves, there are many auxiliary codes necessary to be able to use the main codes efficiently. Several such codes have been installed and utilized during the EMERALD project, e.g. a new NJOY version and JANIS for the manipulation of cross section data, and BOT3P for neutron transport code input and output treatment.

Nuclear criticality safety is a term meaning all actions aimed at the prevention of a criticality accident. Originally, fresh fuel was assumed in the criticality safety analyses for the storage and transport of spent fuel assemblies also. Nowadays, the increased use

of burnable absorbers and the trend towards higher enrichments and burnups call for a more realistic approach that pays attention to the changes in assembly composition during irradiation. Taking the burnup related changes in isotopic concentrations into account is referred to as burnup credit (BUC) [28], the use of which can reduce the conservatism in the design of spent fuel storage and transport equipment, thus leading to considerable savings in the costs.

A number of comparisons with experimental results, as well as results obtained by calculation elsewhere, have been made using the CASMO-4 and Monteburns 1.0 codes [23]. CASMO, Studsvik Scandpower's code for generation of cross section data, is widely used all over the world for ICFM studies on both BWR and PWR reactors as well as for other applications. An example of a comparison between calculated (C) and experimental (E) concentrations of certain isotopes in fuel from a VVER reactor [26] is shown in Figure 9, together with a simple schematic description of the system used for criticality analyses of configurations containing nuclear fuel. VTT participates in the working groups of AER and NEA, where benchmark comparisons between measured data and results obtained using different code systems are made in order to establish and improve the accuracy of criticality safety analyses and isotopic concentration calculations [24, 27]. During the EMERALD project, the code ABURN has been developed at VTT. It couples the MCNP4C Monte Carlo code and the ORIGEN2 isotopic depletion code with the aim to make burnup credit calculations easier and more accurate.

Although sensitivity and uncertainty analysis is already often a part of the work when different codes are applied to various problems, a more generic examination of this topic is under way. After a literature study, the influence of uncertainties in cross section data measurements on different calculated reactor parameters is being investigated in a Master's thesis.

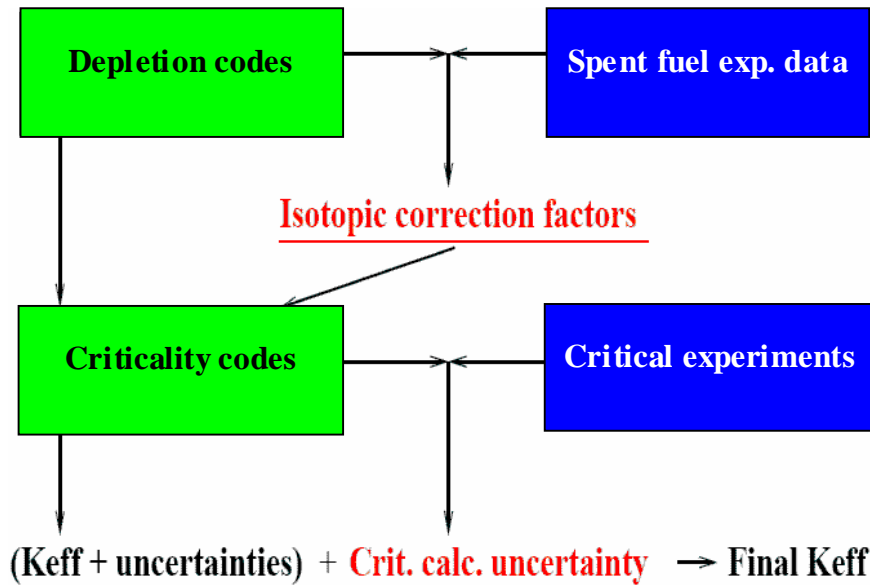
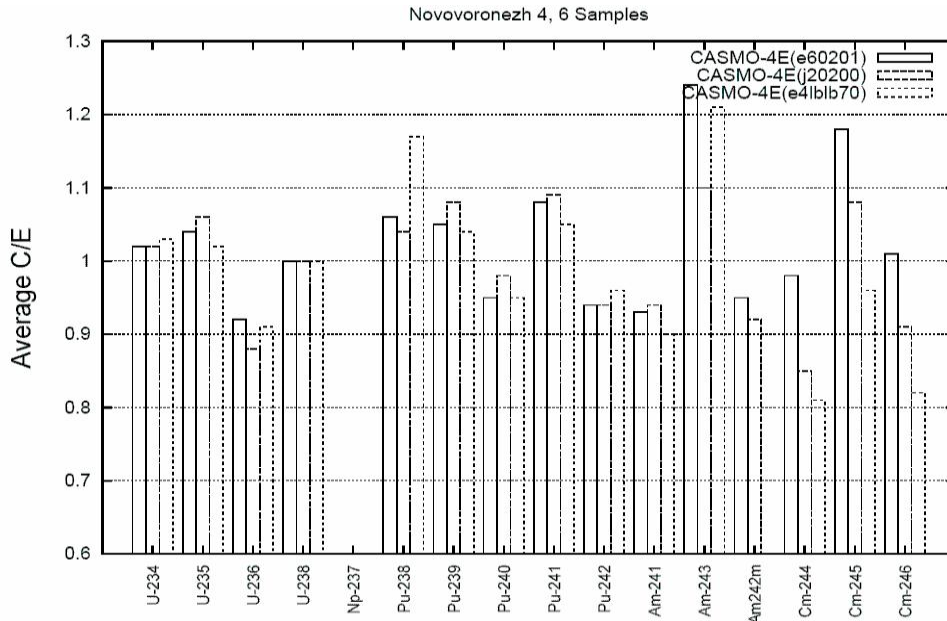

Figure 9. Testing of CASMO-4E against VVER PIE (post irradiation examination) data.

Reactor dynamics

With the reactor dynamics codes developed at VTT, i.e. TRAB, TRAB-3D, and HEXTRAN, it is possible to perform transient analyses for cores with square or hexagonal fuel bundle geometry for boiling water as well as pressurized water reactors. An important limitation of the present codes, however, has been their inability to handle coolant flow reversal in a flow channel, a phenomenon that can be encountered in e.g. BWR ATWS cases or at natural circulation conditions in connection with VVER power excursions.

As a solution to this problem, two existing computer codes, the TRAB-3D reactor dynamics code and the SMABRE thermal hydraulics code [2, 19], have been coupled together using an internal coupling scheme [20]. This means that TRAB-3D performs only the neutronics and heat transfer calculation, whereas SMABRE takes care of the hydraulics calculation of the whole cooling circuit including the reactor core. The solution will be somewhat less accurate than with the standard TRAB-3D version, but the coupled code TRAB-3D/SMABRE should be able to calculate transients with flow reversal in the reactor core or the core by-pass with reasonable accuracy. Also, the new internal coupling will make the future modelling of in-core cross-flows in PWR (such as EPR) open core geometry possible.

The coupling of TRAB-3D and SMABRE is described in more detail in a special article below.

As a future solution to various reactor dynamics problems, the highly accurate PLIM thermal hydraulics solver has been developed during earlier research programs already. It will for instance be able to track moving fronts, like boron fronts, accurately and also to deal with flow reversals. It has previously been successfully applied to several limited problems, but its use in full BWR circuit dynamics calculations, where the hydraulics solution is strongly coupled to other phenomena, i.e. neutronics and heat transfer, has proved difficult and sensitive to small disturbances.

In order to make the solver more robust, and to enhance its modelling capabilities, a new basic solution method has been created. The theoretical work on this model has been completed during the EMERALD project. The work will continue with a reprogramming of the CFDPLIM computer code. The new solver combines the PLIM method with more traditional-type hydraulics methods, with the former taking care of the convection phenomena and the latter making the coupling between the hydraulics equations stronger. A new accurate way of forming the matrices used in the model has also been implemented and these new features are expected to improve the program's robustness, make the treatment of flow channel boundary conditions easier and reduce the importance of numerical parameters given in the input, thus facilitating the practical use of the solver.

In a Doctor's thesis [4], the validation of the codes developed in Finland for the safety analyses of light water reactors in design basis accidents have been studied. The validation efforts and applications of the thermal hydraulics code SMABRE and the three-dimensional neutron kinetics codes are described both for the codes separately and for coupled systems. Material from two European Union projects, in which ten transients at real VVER plants have been documented, as well as other international benchmarks has been utilized. The main steam line break in different kinds of plants has furthermore been used as an example of the application of coupled codes in safety analysis.

A new procedure for sensitivity and uncertainty analysis has been developed and applied to HEXTRAN-SMABRE calculations [30]. It could be used for the TRAB-3D code as well. This tool generates input data, starts the calculations and computes certain statistical sensitivity measures. Results obtained for a Loviisa plant turbine trip case are reported in [4] (Figure 10).

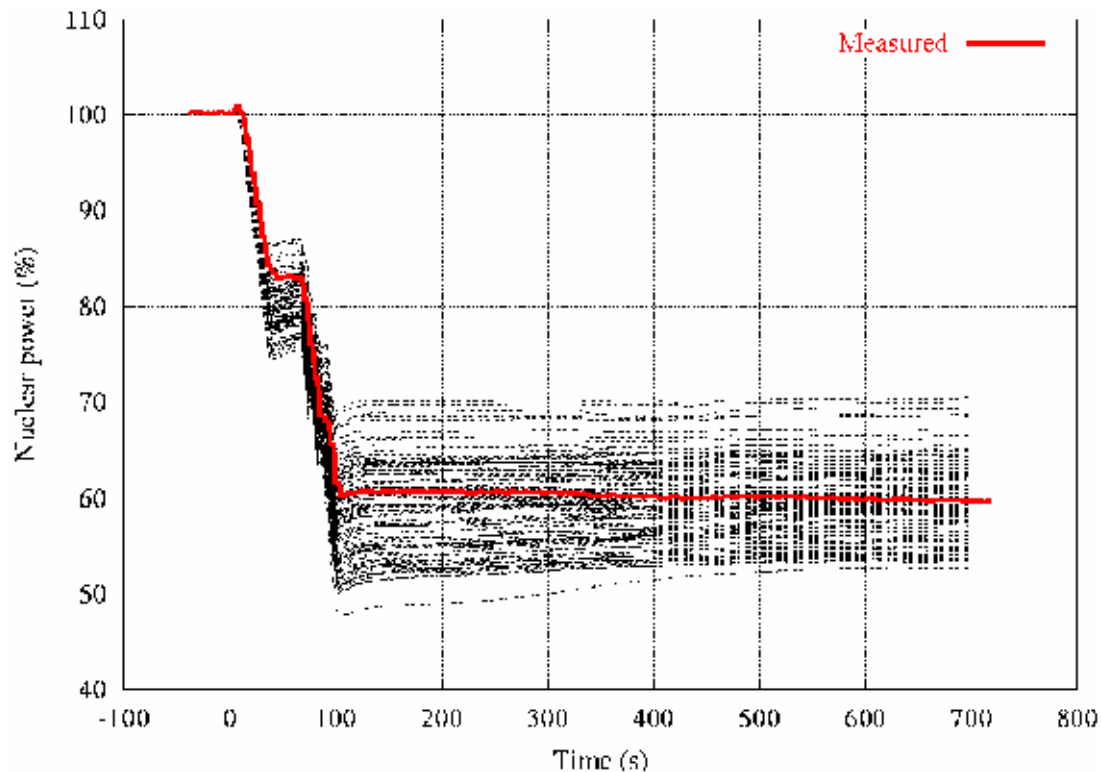

Figure 10. Measured neutron power in a turbine trip test in Loviisa-1 and 100 calculated results with the HEXTRAN-SMABRE code as a part of uncertainty and sensitivity analysis.

Several improvements in the models used in the dynamics codes have been made, often in connection with benchmark problems. For instance the possibility to give the gas gap heat transfer parameters separately for each node in the 3D core as a function of the average fuel temperature in the node has been implemented in the HEXTRAN and TRAB-3D codes. The normal hydraulic channel calculation subroutines in TRAB, taking care of the calculation of core channels and all BWR pressure vessel internals except the steam separators and steam dome, were modified to allow superheated steam calculation.

As a first step towards three-dimensional thermal hydraulics modelling in reactor dynamics, a preliminary study of calculating the boiling water reactor fuel bundle internal void distribution using the 3D porous medium approach was made. The future results of this exercise can be compared to measured data available from the OECD BWR full-mesh bundle test (BFBT) benchmark.

In order to facilitate the creation of radial charts and their animation from the output of the dynamics codes, a new visualization tool based on Matlab was developed.

International research co-operation

Because the resources of a single country are limited, research in reactor physics and dynamics is very much dependent on international co-operation, where the results of the work are presented e.g. in the form of benchmark studies [29] and other comparisons of measurements and computational results [31], at conferences [3, 6, 25] and in international publications [7, 11, 21]. Finnish participation in for instance the work of NEA, IAEA, AER, NKS, and other Nordic co-operation is also included in the project.

Two international conferences and one seminar were arranged within the EMERALD project. The 11th meeting on “Reactor Physics Calculations in the Nordic Countries” was held in April 2003 and the 14th “Symposium of AER on VVER Reactor Physics and Reactor Safety” in September 2004. The former gathered 46 participants representing 13 organizations in 6 countries, the latter 73 participants from 11 countries. Somewhat smaller-sized was the seminar on “NKS-R 3D Transient Methodology for the Safety Analysis of BWRs” just before the Nordic reactor physics meeting. Naturally, the results of the project were quite extensively presented at these three occasions on its own home ground and the proceedings have been published by VTT [5], NKS in Denmark [1], and KFKI in Hungary [22], respectively.

Education of experts

As its predecessors, the EMERALD project has continuously contributed to increasing and maintaining nuclear know-how in Finland by educating new experts and transferring information through international organizations and co-operation. In connection with this project, VTT has usually employed at least 1–2 students as research trainees during the summers to work in the field of reactor physics and dynamics. Some of them have later continued as part or full time employees at VTT and others are engaged in reactor analysis or related nuclear work elsewhere. Members of the project team have also participated in domestic as well as international training courses. The reactor physics and dynamics work within EMERALD has resulted in a Doctor’s (thermal hydraulics, [4]), a Licentiate’s (cross sections, [13]) and a Master’s (criticality safety, [23]) thesis. Two more Doctor’s theses (on code development and validation using Monte Carlo and deterministic transport methods) are well under way and expected to be completed in 2007. Furthermore, another Licentiate’s thesis and two more Master’s theses will be based upon the tasks of the project.

Applications

As the code system that is the objective of the project will cover the whole range of calculations, from handling of basic nuclear data, i.e. cross section libraries, over fuel and core analyses in normal operating conditions to transient and accident studies, it is to be used for research as well as the needs of the safety authorities and power utilities in order to ensure safe and economic use of the nuclear power plants. Correct evaluation of neutron cross section data is the basis of everything else, static core calculations are needed for in-core fuel management, but also to provide starting-points for transient analyses, and the dynamics calculations aim at identifying and avoiding situations that could jeopardize the safety of the nuclear installations.

Conclusions

During the EMERALD project, VTT's computer code system for both steady-state and transient reactor analysis has been further developed and also validated through international benchmarks and other comparisons. Cross section libraries and methods for criticality safety calculations have been investigated. Monte Carlo methods have been utilized for different purposes and necessary tools have been acquired to make the calculations and the handling of input and output more efficient. In stationary reactor physics, new codes and scripts have been developed for Monte Carlo, nodal and deterministic transport calculations as well as for studies of criticality safety and isotopic concentrations. In reactor dynamics, two computer codes were coupled together in order to cope with problems that the previous codes are not equipped for, especially coolant flow reversal in flow channels. Methods and codes for sensitivity and uncertainty analysis in reactor physics and dynamics have been studied and also implemented in practice. The importance of such analyses will increase in the near future, as best estimate models together with uncertainty evaluations will continue to replace calculations based upon conservative assumptions.

References

1. Daavittila, A. 3D analysis methods – study and seminar. Includes the proceedings of the NKS-R 3D BWR Transient Methodology Seminar, Espoo, April 8, 2003. NKS-89, published by the NKS Secretariat, Roskilde, Denmark. 13 p. + app. 101 p. presentations. ISBN 87-7893-147-9.
http://130.226.56.167/nordisk/publikationer/1994_2004/NKS-89.pdf.

2. Daavittila, A., Hämäläinen, A. & Kyrki-Rajamäki, R. Effects of secondary circuit modeling on results of PWR MSLB benchmark calculations with new coupled code TRAB-3D/SMABRE. *Nuclear Technology*, Vol. 142, No. 2, May 2003, pp. 116–123.
3. Daavittila, A., Hämäläinen, A., Miettinen, J. & Rätty, H. Transient and fuel performance analysis with VTT's coupled code system. *International Topical Meeting on Mathematics and Computation, Supercomputing, Reactor Physics and Nuclear and Biological Applications*, September 12–15, 2005, Avignon, France. (Invited paper).
4. Hämäläinen, A. Applying thermal hydraulics modelling in coupled processes of nuclear power plants. VTT Publications 578, Espoo 2005. (Doctor's thesis, Lappeenranta University of Technology, Department of Energy and Environmental Technology). 103 p. + app. 99 p. ISBN 951-38-6667-X; 951-38-6668-8. <http://virtual.vtt.fi/inf/pdf/publications/2005/P578.pdf>.
5. Höglund, R. (ed.). *Reactor Physics Calculations in the Nordic Countries. Proceedings of the 11th Nordic Reactor Physics Meeting*, Espoo & m/s Romantika, April 9–10, 2003. VTT Processes, VTT Symposium 230. Espoo, 2003. 180 p. ISBN 951-38-6286-0; ISSN 1455-0873. <http://virtual.vtt.fi/inf/pdf/symposiums/2003/S230.pdf>.
6. Höglund, R. Reactor physics and dynamics research within the EMERALD project. *XII Meeting on Reactor Physics Calculations in the Nordic Countries*, May 19–20, 2005, Halden, Norway. 6 p.
7. Kliem, S., Danilin, S., Hämäläinen, A., Hádek, J., Keresztúri, A. & Siltanen, P. Qualification of coupled 3D neutron kinetic/thermal hydraulic code systems by the calculation of main steam line break benchmarks in a NPP with VVER reactor. (To be published in *Nuclear Science and Engineering*).
8. Kotiluoto, P. The new deterministic 3-D radiation transport code MultiTrans: C5G7 MOX fuel assembly benchmark. *International Conference on Supercomputing in Nuclear Applications SNA'2003*. September 22–24, 2003, France.
9. Kotiluoto, P. Verification of MultiTrans calculations by the VENUS-3 benchmark experiment. *Journal of ASTM International*, Volume 3, Issue 3 (March 2006). 6 p.

10. Kotiluoto, P. & Wasastjerna, F. VENUS-2 MOX-fuelled reactor dosimetry benchmark calculations at VTT. International Topical Meeting on Mathematics and Computation, Supercomputing, Reactor Physics and Nuclear and Biological Applications, September 12–15, 2005, Avignon, France. 12 p.
11. Langenbuch, S., Krzykacs-Hausmann, B., Schmidt, K.-D., Hegyi, G., Keresztúri, A., Kliem, S., Hadek, J., Danilin, S., Nikonov, S., Kuchin, A., Khalimanchuk, V. & Hämäläinen, A. Comprehensive uncertainty and sensitivity analysis for coupled code calculation of VVER plant transients. Nuclear Engineering and Design, 2005, Vol. 235:2–4, pp. 521–540.
12. Leppänen, J. Cross section library based discrepancies in MCNP criticality calculations. Proceedings of the International Conference Nuclear Energy for New Europe 2003. September 8–11, 2003, Portorož, Slovenia. Paper 101. 8 p.
13. Leppänen, J. Systematic comparison of evaluated data files. VTT Processes, Project report PRO1/P7009/04. Espoo 2004. (LicScTech thesis, Helsinki University of Technology, 2004). 104 p.
14. Leppänen, J. A systematic study of cross section library based discrepancies in LWR criticality calculations. In: SAFIR Interim Report. Espoo: Technical Research Centre of Finland (VTT), 2004. VTT Research Notes 2272. Pp. 30–37. ISBN 951-38-6515-0; 951-38-6516-9 ISSN 1235-0605. <http://www.vtt.fi/inf/pdf/tiedotteet/2004/T2272.pdf>.
15. Leppänen, J. Diffusion code group constant generation using the Monte Carlo method. XII Meeting on Reactor Physics Calculations in the Nordic Countries, May 19–20, 2005, Halden, Norway. 13 p.
16. Leppänen, J. A new assembly-level Monte Carlo neutron transport code for reactor physics calculations. International Topical Meeting on Mathematics and Computation, Supercomputing, Reactor Physics and Nuclear and Biological Applications, September 12–15, 2005, Avignon, France. 12 p.
17. Leppänen, J. Current status of the PSG Monte Carlo neutron transport code. PHYSOR-2006, September 10–14, 2006, Vancouver, British Columbia, Canada. 10 p.

18. Mattila, R. Three-dimensional analytic function expansion nodal model, ANS Topical Meeting on Advances in Nuclear Fuel Management III. October 5–8, 2003, Hilton Head Island, South Carolina, USA. CD-ROM Proceedings, American Nuclear Society, LaGrange Park, IL (2003), Paper 06-05. 9 p. ISBN 0-89448-670-5.
19. Miettinen, J., Vanttola, T., Daavittila, A. & Rätty, H. The combined thermohydraulics-neutronics code TRAB-SMABRE for 3D plant transient and accident analyses. 12th International Conference on Nuclear Engineering. April 25–29, 2004, Washington D.C., USA. ICONE-12-49452. 7 p.
20. Miettinen, J. & Rätty, H. The coupled code TRAB-3D-SMABRE for 3D transient and accident analyses. In: SAFIR Interim Report. Espoo: Technical Research Centre of Finland (VTT), 2004. VTT Research Notes 2272. Pp. 38–45. ISBN 951-38-6515-0; 951-38-6516-9; ISSN 1235-0605.
<http://www.vtt.fi/inf/pdf/tiedotteet/2004/T2272.pdf>.
21. Mittag, S., Grundmann, U., Weiss, F.-P., Petkov, P. T., Kaloinen, E., Keresztúri, A., Panka, I., Kuchin, A., Ionov, V. & Powney, D. Neutron-kinetic code validation against measurements in the Moscow V-1000 zero-power facility. Nuclear Engineering and Design, 2005, Vol. 235:2–4, pp. 485–506.
22. Proceedings of the fourteenth Symposium of AER, Espoo, Finland and Baltic Sea Cruise to Stockholm, September 13–17, 2004. Kiadja a KFKI Atomenergia Kutatóintézet, Budapest, November 2004. 732 p. + app. 9 p.
23. Ranta-aho, A. Validation of reactor physics codes for predictions of isotopic compositions of high burnup LWR fuels. VTT Processes, Project report PRO1/P7006/04. Espoo 2004. (MScTech thesis, Helsinki University of Technology, 2004). 147 p.
24. Ranta-aho, A. Isotopic composition and criticality safety calculation system at VTT. 10th Meeting of the AER Working Group E entitled Physical Problems on Spent Fuel, Radwaste and Decommissioning of Nuclear Power Plants, April 18–20, Villa Szondra by Modra, Slovakia. 14 p.
25. Ranta-aho, A. Use of SSP code systems in Finland. 2005 Studsvik Scandpower International Users Group Meeting, June 1–3, 2005, Charlotte, North Carolina, USA. 22 p.

26. Ranta-aho, A. Validation of CASMO-4E against radiochemical assay data from Novovoronezh 4. 11th Meeting of the AER Working Group E ‘Physical Problems of Spent Fuel, Radwaste, and Decommissioning of Nuclear Power Plants’, April 11–12, 2006, Hrotovice, Czech Republic. 10 p.
27. Ranta-aho, A. Validation of depletion codes against VVER-440 spent fuel data. OECD/NEA/NSC WPNCS Workshop on the need for post irradiation experiments to validate fuel depletion calculation methodologies, May 11–12, 2006, Rez near Prague, Czech Republic.
28. Ranta-aho, A. Validation of depletion codes for burnup credit evaluation of LWR assemblies. PHYSOR-2006, September 10–14, 2006, Vancouver, British Columbia, Canada. 11 p.
29. Syrjälähti, E. & Hämäläinen, A. HEXTRAN-SMABRE calculation of the VVER-1000 coolant transient benchmark. 11th International Topical Meeting on Nuclear Reactor Thermal Hydraulics (NURETH 11), October 2–6, 2005, Avignon, France. (To be published also in ‘Progress in Nuclear Energy’).
30. Syrjälähti, E. New sensitivity analysis tool for VTT’s reactor dynamics codes. International Youth Nuclear Congress IYNC 2006, June 18–23, 2006, Stockholm, Sweden and Olkiluoto, Finland. Paper No. 181. 11 p.
31. Vanttola, T., Hämäläinen, A., Kliem, S., Kozmenkov, Y., Weiss, F.-P., Keresztúri, A., Hádek, J., Strmensky, C., Stefanova, S., Kuchin, A. et al. Validation of coupled codes using VVER plant measurements. Nuclear Engineering and Design, 2005, Vol. 235:2–4, pp. 507–519.
32. Wasastjerna, F. Importances for MCNP calculations on a shield with a penetration. The American Nuclear Society’s 14th Biennial Topical Meeting of the Radiation Protection and Shielding Division, April 3–6, Carlsbad, New Mexico, USA 12 p.

2.2 Development of Monte Carlo neutron transport methods for reactor physics applications

Jaakko Leppänen
VTT

Abstract

PSG (Probabilistic Scattering Game) is a new Monte Carlo neutron transport code, developed at the VTT Technical Research Centre of Finland. The code is specifically designed for reactor physics applications, particularly at the fuel assembly level. Group constant generation for deterministic reactor simulator codes is considered as one of the main motivations for PSG development. This paper presents an overview of the main features of PSG, together with some typical results.

Introduction

The Monte Carlo method is widely used for various neutron transport problems encountered in reactor physics, especially for tasks requiring the detailed modelling of geometry and nuclear interactions. Typical applications include criticality safety analyses, radiation shielding calculations, detector modelling and the validation of deterministic transport codes. The Monte Carlo method is a computing-intensive calculation technique, and the applications are still today restricted by the available computer resources.

It is likely that the interest in Monte Carlo calculation will increase in the future, along with the development in raw computing power and the use of parallel calculation. New applications will probably arise with code development. One of such applications is the production of input data for reactor simulator codes, which are used for static or dynamic full-core analyses. This *group constant* generation is currently performed using second generation lattice codes, based on advanced deterministic transport methods. The task is becoming increasingly challenging, along with the development in nuclear technology. Increasing fuel burnup, MOX-fuels and next-generation reactor concepts may require the use of more elaborate transport methods, and Monte Carlo calculation seems like the obvious choice.

Group constant generation basically implies the *homogenisation* [1] of the detailed geometry description: the energy dependence of the interaction parameters is condensed into a few discrete energy groups and the spatial dependence into a mesh of

macroscopic homogeneous regions. The homogenisation is performed as an infinite-lattice calculation, in which the fuel assembly is surrounded by an infinite array of similar cells. When the Monte Carlo method is applied for homogenisation, the problem is basically reduced to the calculation of the *diffusion coefficient*. This is the only parameter without any analogy in the continuous-energy Monte Carlo calculation. The problem has been approached in various studies [2–6], but the topic is not as thoroughly covered as could be expected.

Group constant generation for deterministic reactor simulator codes is also one of the main motivations for the development of PSG, a new Monte Carlo neutron transport code developed at the VTT Technical Research Centre of Finland. The project was started as an independent free-time activity in September 2004. First reasonable results were obtained by the end of the year and code development was included in the VTT research programme in April 2005. Since then the code development has been included in the SAFIR/EMERALD project. A doctoral thesis is being prepared for the Helsinki University of Technology and it is expected to be completed by the end of year 2007. Three research papers have been presented in international conferences [7–9]. Two more papers are being prepared and a scientific review article has been planned.

The PSG Code

PSG can be characterised as a three-dimensional continuous-energy neutron transport code, which uses an analog Monte Carlo game for neutron transport and the *k*-eigenvalue criticality source method for simulating the fission chain reaction. The geometry description is not restricted, but the code is best suited for reactor physics calculations, especially at the fuel assembly level. Some of the non-traditional features of PSG are introduced below.

Monte Carlo particle transport methods are conventionally based on a ray-tracing algorithm, which requires the use of complicated geometry routines. The simulation proceeds by a random walk process, in which individual neutrons are tracked from one randomly sampled interaction to the next. The geometries are composed of several homogeneous material regions. Since the material properties change when moving from one material cell to the next, the neutron has to be stopped at the boundary surface before proceeding with the random walk. This requires the calculation of the optical distance to the nearest boundary surface, which becomes a complicated task when several material regions are involved.

PSG relies on a different approach, introduced by E. R. Woodcock in the 1960's. The Woodcock *delta-tracking* method [10] is essentially a so-called rejection technique, which is used for sampling collision distances from a piece-wise continuous probability

distribution, in which the points of discontinuity are not known. The delta-tracking method eliminates the need to stop the tracking at each material boundary, and eventually, the need to calculate the surface distances. This simplifies the geometry routines and may result in a considerable speed-up in complicated geometries. The delta-tracking method is not widely used by general-purpose Monte Carlo neutron transport codes, although there are some exceptions as well [11–14]. The reason is probably the limited capability to calculate integral reaction rates inside small, and especially optically thin volume regions. This limitation can be considered significant in detector-type calculations, but the method is well suited for the typical applications of PSG in particular.

PSG uses standardised ENDF-format interaction data [15], read from ACE-format cross section libraries. This data format was originally developed for the Los Alamos MCNP-code [16], which is also the main reference code used in PSG validation. The shared data format has the advantage that the uncertainties originating from the fundamental interaction data can be eliminated. All reaction channels are modelled according to classical collision kinematics and ENDF reaction laws. Cross sections are reconstructed in a uniform energy grid, which is used for all isotopes. This approach has the advantage that the interpolation of cross sections between two tabulated values requires only a single iteration, each time the neutron changes its energy. The result is a significant increase in efficiency. The price is paid in computer memory, which is wasted for storing redundant data points.

Parallel calculation is becoming increasingly important in scientific computation. The Monte Carlo method is particularly well suited for parallelisation, due to the linearity of the neutron transport process. Most of the state-of-the-art Monte Carlo codes are capable of parallel calculation, and this aspect has been taken into consideration already from the beginning of PSG development.

PSG has the capability to calculate all input parameters needed for reactor simulator calculations based on few-group nodal diffusion methods. This includes the group-wise diffusion coefficients, which are calculated using two alternative and fundamentally different methods. One of the problems encountered in group constant generation is the distortion of flux spectrum due to non-physical zero-current boundary conditions. This is a methodological problem, which arises from the fact that the homogenisation is carried out as an infinite-lattice calculation. Deterministic lattice codes handle the problem using leakage corrections [17], which, however, are not easily translated in Monte Carlo. The development of a Monte Carlo specific leakage model is one of the most important future goals in PSG development. Some work has been carried out already, and a collaboration project with Électricité de France and École Polytechnique de Montréal is being planned.

Typical results

So far the applicability of PSG for group constant generation has been limited by the incapability to perform burnup calculation. Some preliminary calculations involving a conceptual initial core of the European Pressurised Reactor (EPR) have been carried out, but most of the studies are related to code validation by comparing PSG results to other transport codes, mainly MCNP4C [16] and CASMO-4E [18]. PSG has also been successfully used for calculating the three-dimensional VENUS-2 MOX-fuelled reactor dosimetry benchmark [9, 19].

The differences in LWR lattice calculations compared MCNP4C results are generally quite small. Effective multiplication factors and homogenised group-wise reaction cross sections in the fast energy group ($E > 0.625$ eV) are within the 95% confidence intervals of the reference results. Larger and systematic discrepancies are encountered in the thermal energy group, but the differences are still well below 1%. Comparison of calculation times shows that PSG runs 4 to 15 times faster than MCNP4C in typical LWR lattice calculations. The factor depends on the geometry and the number of calculated output parameters.

Comparison to CASMO-4E results is less straightforward, due to certain fundamental differences in the calculation methods and in the interaction data. Even if the cross section libraries used by the two codes are based on the same evaluated nuclear data file, some uncertainty must be accounted for the pre-processing and the micro-group condensation of the CASMO-4E data. The differences in the calculated group constants are in the order of few per cent, which is quite typical for a comparison between a deterministic and a Monte Carlo code. PSG is able to reproduce the diffusion coefficient calculated by CASMO-4E with similar few per cent accuracy. Larger discrepancies are encountered in geometries where the validity of the diffusion approximation breaks down.

Figure 11 shows an example of graphical output produced by PSG. The example case is a 10×10 BWR fuel assembly, for which the thermal flux and fission power distributions are plotted using different colour schemes. It is seen that the thermal flux is peaked at the moderator channels, which increases the power in the nearby fuel pins. Burnable absorber pins are clearly distinguished from the rest by the low fission rate caused by thermal neutron absorption in the gadolinium isotopes. This type of visualisation is useful for debugging the geometry model for input errors and understanding the neutronics of the system.

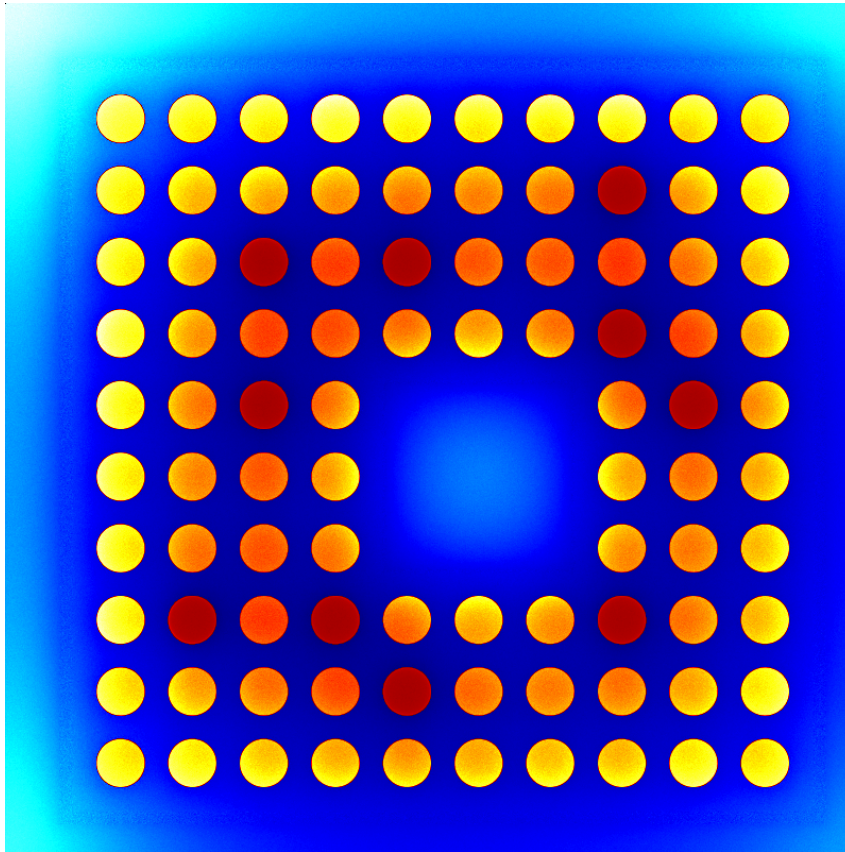

Figure 11. Thermal flux (“cold” shades) and fission power (“hot” shades) distributions in a BWR fuel assembly as calculated by PSG. Light and dark colours indicate high and low values, respectively.

Conclusions

At its current stage of development, the PSG code can be considered as a versatile research tool that is best used in parallel with other transport calculation codes. The code is fast and efficient, and it can be run in a multi-processor computing environment. PSG is not ready to be used as a production code in a routinely manner, although it has the capability to calculate all the parameters needed in nodal diffusion calculations. The most significant restricting factor is the incapability to model fuel depletion and to produce group constant data for burned fuel.

PSG has been validated in various LWR lattice calculations by comparing the results to reference data produced by MCNP4C and CASMO-4E. The results have been very promising, although certain anomalies still persist. Code development is currently frozen and the main focus turned to the completion of a doctoral dissertation. Major long-term goals include the development of Monte Carlo specific leakage models and the capability to perform burnup calculation.

References

1. Stacey, W. M. Nuclear Reactor Physics. John Wiley & Sons, Inc., 2001.
2. Gast, R. C. A Procedure for Obtaining Neutron-Diffusion Coefficients from Neutron-Transport Monte Carlo Calculations. WAPD-TM-1446, Bettis Atomic Power Laboratory, 1981.
3. Redmond II, E. L. Multigroup cross section generation via Monte Carlo methods. Ph.D. Thesis, Massachusetts Institute of Technology, 1997.
4. Ilas, G. & Rahnema, F. A Monte Carlo based nodal diffusion model for criticality analysis of spent fuel storage lattices. *Ann. Nucl. Energy*, 30:2003, pp. 1089–1108.
5. Tohjoh, M. Watanabe, M. & Yamamoto, A. Application of continuous-energy Monte Carlo code as a cross-section generator of BWR core calculations. *Ann. Nucl. Energy*, 32:2005, pp. 857–875.
6. Marck, S. C. van der et al. Homogenized Group Cross Section by Monte Carlo. In: Proc. PHYSOR-2006 American Nuclear Society's Topical Meeting on Reactor Physics Organized and hosted by the Canadian Nuclear Society, Vancouver, BC, Canada, Sept. 10–14, 2006.
7. Leppänen, J. Diffusion Code Group Constant Generation Using the Monte Carlo Method. In: Proc. XII Meeting on Reactor Physics Calculations in the Nordic Countries, Halden, Norway, May 17–18, 2005.
8. Leppänen, J. A New assembly-level Monte Carlo neutron transport code for reactor physics calculations. In: Proc. International Topical Meeting on Mathematics and Computation, Supercomputing, Reactor Physics and Nuclear and Biological Applications, M&C 2005, Avignon, France, Sept. 12–15, 2005.
9. Leppänen, J. Current Status of the PSG Monte Carlo Neutron Transport Code. In: Proc. PHYSOR-2006 American Nuclear Society's Topical Meeting on Reactor Physics Organized and hosted by the Canadian Nuclear Society, Vancouver, BC, Canada, Sept. 10–14, 2006.
10. Woodcock, E. R. et al. Techniques Used in the GEM Code for Monte Carlo Neutronics Calculations in Reactors and Other Systems of Complex Geometry. In: Proc. Conference on Applications of Computing Methods to Reactor Problems, ANL-7050, Argonne National Laboratory, 1965.

11. Ondis II, L. A., Tyburski, L. J. & Moskowitz, B. S. RCP01 – A Monte Carlo program for solving neutron and photon transport problems in three-dimensional geometry with detailed energy description and depletion capability. B-TM-1638, Bettis Atomic Power Laboratory, 2000.
12. Sutton, T. N. et al. The Physical Models and Statistical Procedures Used in the RACER Monte Carlo Code. KAPL-4840, Knolls Atomic Power Laboratory, 1999.
13. Armishaw, M. J. An introduction to the Hole Geometry Package as used in MONK and MCBEND. ANSWERS/MONK/REPORT/003, Serco Assurance.
14. Morimoto, Y. et al. Neutronic analysis code for fuel assembly using a vectorized Monte Carlo method. Nucl. Sci. Eng., 103:1981, pp. 351–358.
15. McLane, V. (ed.). ENDF-102, Data Formats and Procedures for the Evaluated Nuclear Data File ENDF-6. BNL-NCS-44945-01/04-Rev., Brookhaven National Laboratory, 2001.
16. Briesmeister, J. F. (ed.). MCNP – A General Monte Carlo N-Particle Transport Code. LA-13709-M, Los Alamos National Laboratory, 2000.
17. Hébert, A. Applied Reactor Physics, IGE-281. Lecture notes. Institut de Génie Nucléaire, École Polytechnique de Montréal, 2005.
18. Rhodes, J. Smith, K. & Edenius, M. CASMO-4E Extended Capability CASMO-4 User's Manual. SSP-01/401, Studsvik Scandpower, 2001. (Proprietary).
19. Messaoudi, N. & Na, B.-C. VENUS-2 MOX-fuelled Reactor Dosimetry Calculations. Final Report, NEA/NSC/DOC(2005)22, OECD/NEA, 2004.

2.3 The coupled code TRAB-3D-SMABRE for 3D transient and accident analyses

Jaakko Miettinen & Hanna Rätty
VTT

Abstract

VTT's three-dimensional TRAB-3D core dynamics code and SMABRE thermal hydraulic system code have been coupled together using an internal coupling scheme in order to increase flexibility in the thermal hydraulics modelling of the core calculation. VTT's reactor dynamics codes have performed well in all the situations that they have originally been designed for. The most important limitation of the present code models is their inability to handle coolant flow reversal in the core channel, a phenomenon that can be encountered in e.g. BWR ATWS cases or VVER power excursions. The new coupling of the two codes is realized on the level of each node of each channel in the core, with each fuel bundle described with its own channel. TRAB-3D performs only the neutronics calculation, SMABRE takes care of the hydraulics calculation of the whole cooling circuit including the reactor core, while heat transfer calculation can be carried out optionally by either code. The codes have earlier been coupled using a parallel coupling scheme. Several modifications were necessary in SMABRE, concerning modelling of hydraulics, heat transfer, geometry and the matrix solution. The accuracy of the steady state calculation in the coupled code has been improved to a level suitable for both PWR and BWR calculations, as compared against the SIMULATE and reference TRAB-3D codes. Presently BWR dynamics calculations are being tested with single disturbances, such as control rod movements, pump coastdown etc. Besides allowing modelling of reversed flow in the core, the internally coupled code will make future modelling of in-core cross-flows or even 3D flow in a PWR (such as EPR) open core geometry possible, e.g. by using the porous medium approach.

Introduction

TRAB-3D [1] is a reactor dynamics code with three-dimensional neutronics coupled to core and circuit thermal hydraulics. The code can be used for transient and accident analyses of boiling (BWR) and pressurized water (PWR) reactors. It includes the BWR circuit model containing one-dimensional descriptions for the main circulation system inside the reactor vessel including the steam dome with related systems, steam lines, recirculation pumps, incoming and outgoing flows and control and protection systems. The one-dimensional TRAB-1D code has been extensively used for the plant analyses

of the Finnish TVO reactors of BWR type. The three-dimensional TRAB-3D has been validated against OECD LWR core transient benchmarks, and real plant transients for the Olkiluoto 1 plant, including pump trip, pressurization transient, instability incident and load rejection test including partial asymmetric scram. Validation of the code is summarized in [4]. TRAB-3D is now in production use for plant transient and accident analyses.

The system code SMABRE [2] models the thermohydraulics of light water reactors using a generalized nodalization scheme similarly with system codes. Originally the code has been developed for small break analyses of PWR and BWR plants. The code can handle two-phase flow in forced flow and stagnant situation, as well as the forced flow during the normal operation and natural circulation after the reactor coolant pump trip. Both codes have been entirely developed at VTT. The validation of SMABRE includes mainly calculations related to tests in integral facilities, which were often arranged as international standard problems by the OECD/CSNI. Validation cases of SMABRE are listed in e.g. [5]. As compared to large system codes, like the RELAP5, CATHARE, and the ATHLET, SMABRE has a limited simulation capability, but by concentrating on the most important modelling aspects around the LWR safety the code can be considered as a rather versatile analysis tool. In the combined products in simulators and integral code systems the analysis the transients and accidents have been possible, which are outside the applicability range of the traditional system codes.

For PWR applications the TRAB-3D and SMABRE codes have been coupled earlier by using the parallel coupling principle: the full core TRAB-3D hydraulics coupled to neutronics and heat transfer, and the coarse SMABRE core hydraulics with fewer channels are solved in parallel. The rest of the circulation system is solved with SMABRE.

VTT's dynamics codes have performed well in all the situations that they have originally been designed for. The most important limitation of the present code models is their inability to handle coolant flow reversal in the core channel, a phenomenon that can be encountered in e.g. BWR ATWS cases or VVER power excursions. To remove this limitation, the TRAB-3D neutronics and the SMABRE thermal hydraulics code have been coupled together using an internal coupling scheme. In the new concept TRAB-3D will perform only the neutronics calculation, SMABRE will take care of the hydraulics calculation of the whole cooling circuit including the reactor core, while the fuel pellet heat conduction and heat transfer on the cladding surface may be calculated by either code, by the user's choice.

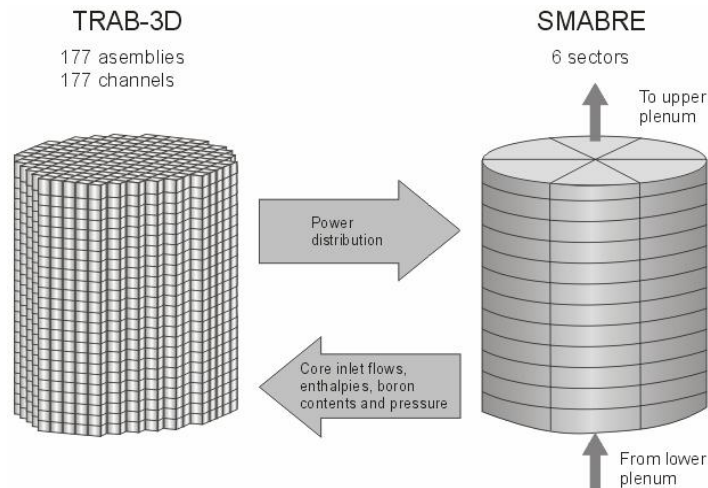

Figure 12. The parallel core coupling principle.

Neutronic-thermohydraulic coupling principles

Three different modes for coupling dynamic core models and system codes are utilised worldwide, called external, internal and parallel coupling. With external coupling the whole core calculation is carried out by the dynamics code, and the system code is used for the rest of the circuit. This approach has not been applied at VTT.

The first realized coupling concept at VTT is parallel coupling, the principles of which are illustrated in Figure 12. In this mode the two coupled codes are running independently with minimum amount of data transfer between the modules. Thermal-hydraulics of the core is calculated with both codes in parallel, but rest of the circulation system is solved with SMABRE. The connection is carried out by data exchange once in a time-step for core inlet flow and outlet pressure into the TRAB direction and core power distribution into the SMABRE direction. VTT has more than a decade of experience in carrying out safety analyses with parallelly coupled three-dimensional codes. The TRAB-3D / SMABRE parallel coupling was validated against the OECD benchmark calculation of main steam line break transient in the TMI-1 PWR plant [6].

In Figure 13 the internal coupling principle has been illustrated. Most of the parameters are transferred in the interface routines called from the main program level. Recalculation of the thermohydraulics is needed after each neutronic iteration. The entire internal coupling was realized on a platform, which allows running all of the code coupling modes, TRAB-3D alone, TRAB-3D coupled with SMABRE parallelly and TRAB-3D coupled with SMABRE internally. The stationary run with SMABRE is typically calculated in a separate run. The platform, however, includes the possibility for an independent SMABRE run, as well as starting the transient calculation with a SMABRE stationary phase from its own input and activating the neutronics in the beginning of the transient.

The principles of connecting the circuit model with the core model are also illustrated in Figure 13. The reactor vessel may be divided into sectors and radial rings for the non-symmetric flow calculation. In the core inlet several rings and sectors may exist, and each section is connected with a number of individual fuel and flow channels of the core. This allows taking into account some transverse features in the thermal hydraulics calculation at the core inlet.

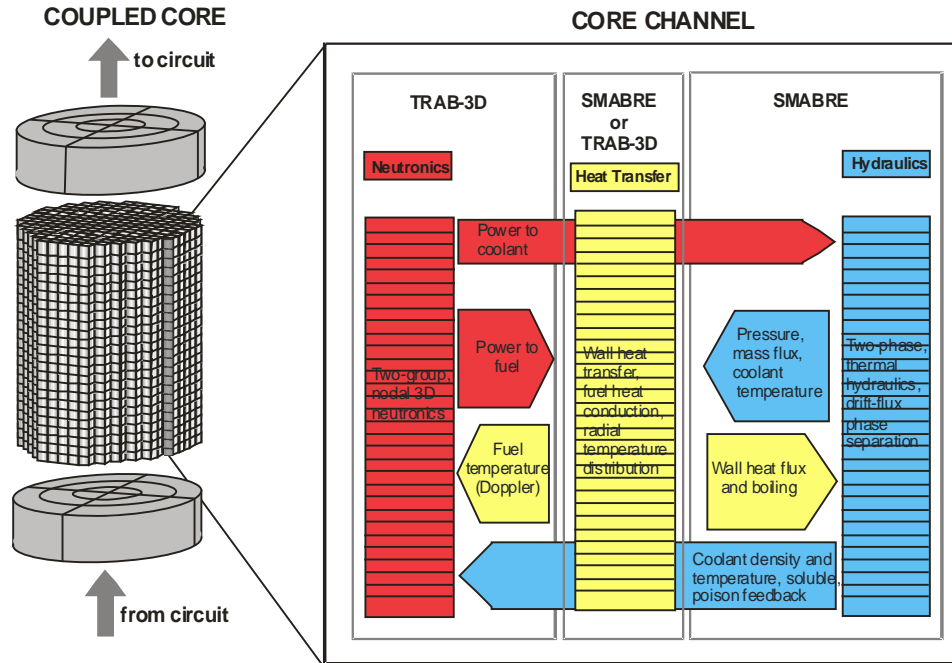

Figure 13. The internal core coupling and connection into radial and circumferential zones in the vessel.

TRAB-3D solves the core neutronics and SMABRE the thermal hydraulics in the reactor systems outside the core and in the core. The heat conduction equations in the fuel are solved in both codes in parallel, by using identical material properties for the fuel rod. For TRAB-3D coupling SMABRE delivers the surface heat flux rates. The parallel calculations help in analysing the calculation methods for the heat conduction. The fuel temperature feedback for the neutronics may optionally be selected based on either the TRAB-3D or SMABRE result.

Realization of the coupling

The plant input used in the development and testing was the TRAB-3D input for the 500 fuel element Olkiluoto BWR core and the 242 node input of SMABRE, in which the core is described by four sectors and 25 axial nodes. The input has originally been developed for the BWR simulator applications. In the initialization phase the core nodalization is automatically expanded into 500 hydraulic channels, one for each fuel element, and after this expansion the thermal hydraulics nodalization contains 12642 nodes.

The TRAB features for describing PWR and BWR bundle geometry and fuel compositions have been maintained. Each bundle is related to an individual flow channel, flow channels may have axial subdivisions, and each fuel element may have an individual fuel rod composition. The SMABRE nodalization enables multidimensional subdivision in the lower and upper plenums through circumferential sectors and radial rings.

The modelling of controls systems as well as the methods for initiating disturbances through TRAB-3D are all included in the coupled code. All the plant controls included in SMABRE are also available, and the input and output signals for control and disturbance functions can be transferred from one code to another according to the user's needs. Some of the control system models are overlapping, but they may be used optionally and compared with respect to similarity.

In the original TRAB-3D the main iteration was carried out for neutronics and inside these external iterations TRAB-3D thermohydraulics was typically repeated ten times. In the internal coupling SMABRE is calculated only once after each neutronics iteration. The convergence of the iteration is determined by TRAB-3D, based on analysing the neutronics convergence. During each outer iteration the new neutron flux corresponding to the core void, coolant temperature and fuel temperature distribution is searched. The heat conduction equation is integrated with new heat transfer and power generation parameters during the iteration step, and as a consequence the core heat flux distribution is changed. In SMABRE the thermal hydraulics is solved by a matrix inversion. The present matrix inversion is based on Gaussian elimination. An iterative matrix inversion has been tested for future use, allowing the modelling of open core structure as well.

The detailed fuel element specific information, with different types of fuel loaded into the core, is included through TRAB-3D input. Initially, the SMABRE input is defined for few radial zones and few circumferential sectors and the core inlet enthalpy into individual channels depends on this subdivision. In the initialization phase core division in few (typically 1 to 18) zones is divided according to the fuel assemblies defined in the TRAB-3D input, still in this phase with identical characteristics, as defined for the zones. The original TRAB-3D input may be used for SMABRE both in the independent and coupled calculation mode. The core may include different fuel element types, with different inlet orifice pressure loss coefficients, local flow area, heat transfer characteristics and local friction, but the original SMABRE input includes only the averaged element characteristics. After reading the TRAB-3D input the element specific information is updated into individual fuel elements, and the calculation is stabilized. After the first run the initialization part automatically calculates flow area and friction data for the original core zones in such a way that in the next run the need for the stabilization is reduced.

The phase separation in TRAB-3D is calculated by using the slip model, i.e. the velocity ratio between the steam velocity and liquid velocity, which is calculated by using separate slip correlations. The flow separation in SMABRE is based on the drift-flux model which allows the simulation of flow reversal in the core during the transient. For accurate thermal hydraulic comparisons an optional solution was created, where the TRAB-3D single-phase and two-phase frictions may be directly used with their original formulations: the slip correlation of TRAB-3D was rewritten into the drift-flux format. The evaporation rate for the subcooled boiling was included as an optional solution, too. The TRAB correlations are formulated as fuel specific. By simple options the user may select, if the original TRAB or existing SMABRE correlations are used for these purposes. The material properties in the fuel rod may be applied based on either the TRAB-3D formalism or SMABRE formalism.

Different versions of the fuel heat transfer calculations may be selected optionally. In one mode the fuel calculation is carried out totally by SMABRE, with the same radial meshing as in TRAB-3D and the Doppler feedback is directly transferred to neutronics. In another mode SMABRE calculates only the heat transfer on the fuel surface and it is transferred to TRAB, which results in a more simplified model than in the present TRAB-3D. The first mode gives better stability characteristics.

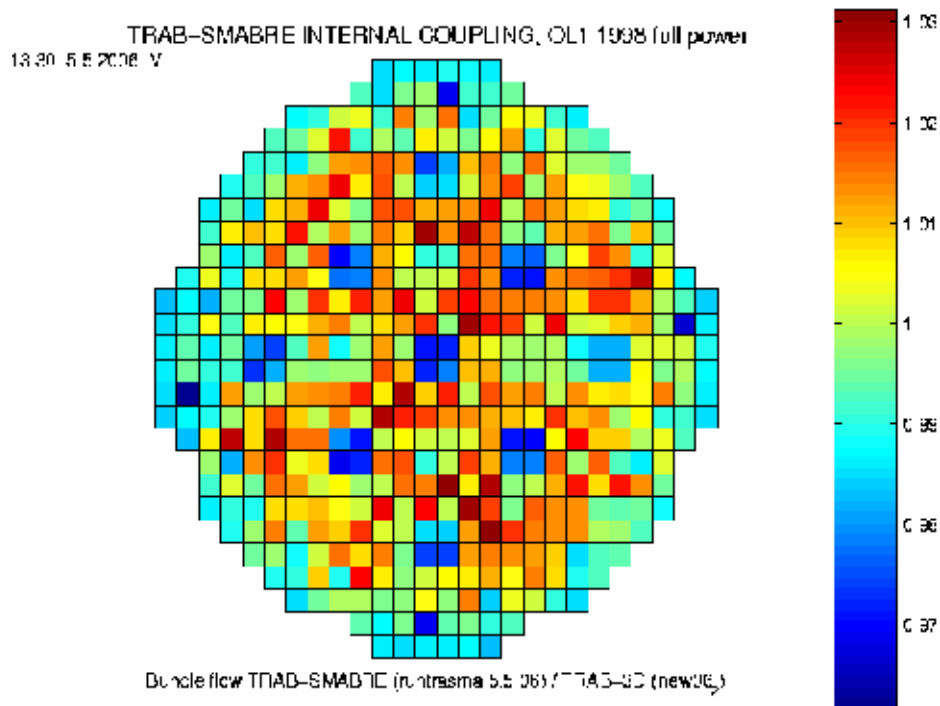

Figure 14. Deviation of the bundle flow distribution between the internally coupled TRAB-SMABRE and original TRAB-3D.

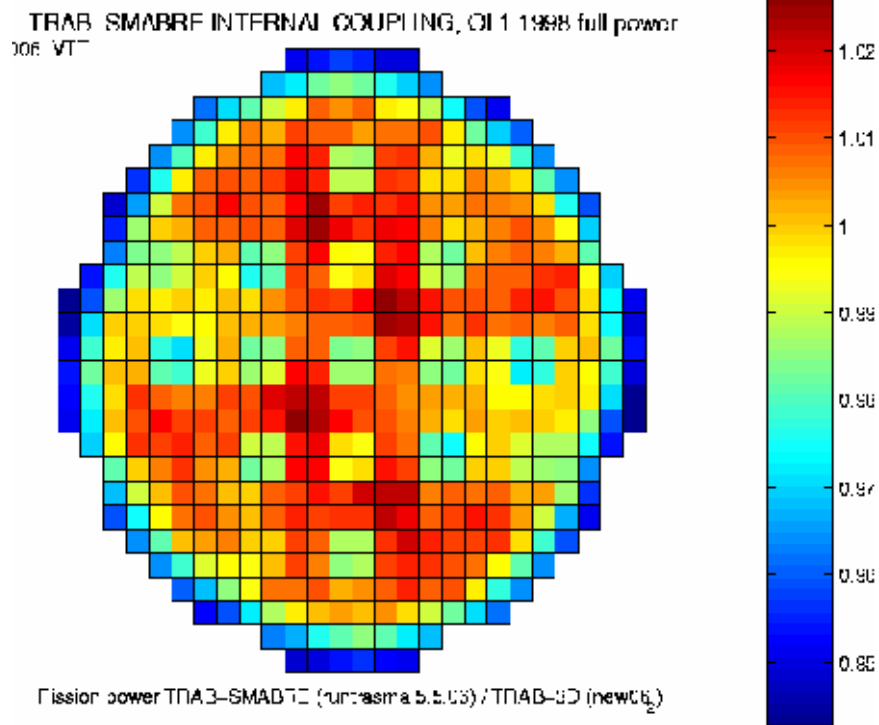

Figure 15. Deviation of the radial power distribution between the internally coupled TRAB-SMABRE and original TRAB-3D.

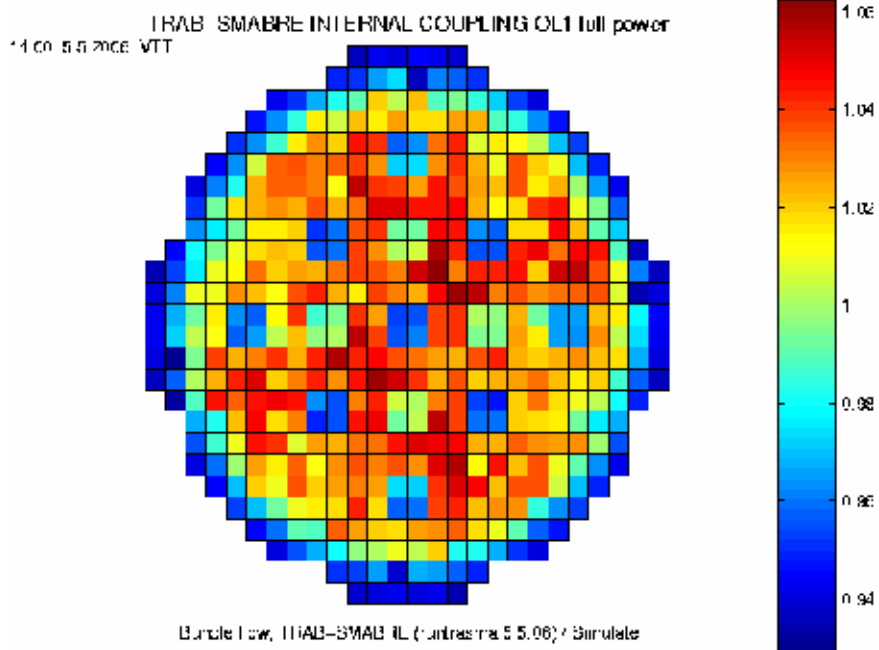

Figure 16. Deviation of the radial flow distribution between the internally coupled TRAB-SMABRE and SIMULATE.

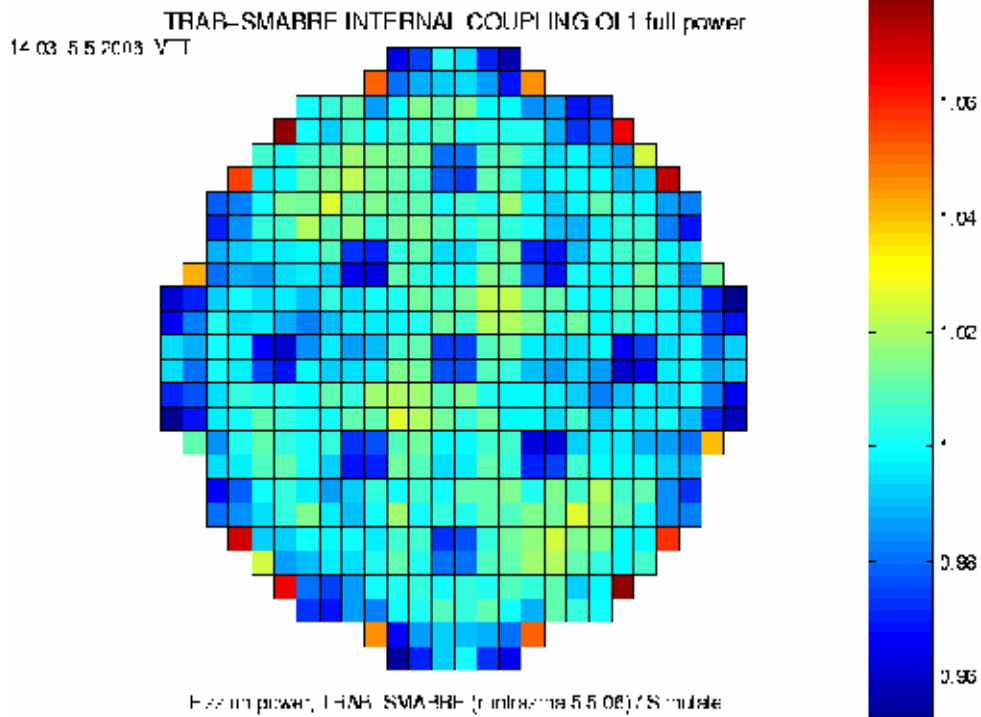

Figure 17. Deviation of the radial power distribution between the internally coupled TRAB-SMABRE and SIMULATE.

Steady state testing results

The internally coupled steady state solution has been tested against both the production version of TRAB-3D and the fuel management code SIMULATE [7].

Compared against TRAB-3D the difference in the steady state bundle flow distribution calculated with the coupled code is from +3 to -4% (TRAB-SMABRE/TRAB-3D, see Figure 14), and against SIMULATE from +4 to -5% (see Figure 16). This accuracy is quite satisfactory when comparing two different thermal hydraulics calculations.

In the relative fission power distribution the difference in the results of the coupled code against TRAB-3D (TRAB-3D-SMABRE/TRAB-3D, see Figure 15) is of the order $\pm 2\%$, except for the outermost circle of bundles where it is around 4–5%. Against SIMULATE the difference is also around $\pm 2\%$, but in certain bundles in the outermost zone the difference is up to 8–12% (see Figure 17). The same difference is found between TRAB-3D and SIMULATE, too, and probably derives from differences in core neutronic boundary conditions. The accuracy of the steady state calculation is thus quite good, and suitable for both PWR and BWR calculations.

Dynamic case testing results

Dynamic testing of the coupled code is presently in progress, and some preliminary results are shown here.

Dynamic testing was started by calculating a null transient in order to demonstrate a stable initial state. The pressure controllers of each code were included and tested against each other. This testing revealed further need to refine the initialization of the stand-alone SMABRE. Presently small disturbances still remain in the process of switching from SMABRE to the coupled code (see Figure 18, the upmost pictures).

Three single parameter disturbances have been tested so far: the partial reactor scram (a reactivity transient) reducing the fission power to the 75% level, the reactor pump coastdown (a flow transient) to the minimum speed resulting with the 60% reactor power, and a steam line flow disturbance with a 13% steam line flow reduction during 0.6 seconds were studied. The tests include rapid thermal hydraulic phenomena and are challenging to the coupled code. The results are displayed as collected in Figure 18.

The results of the two codes are qualitatively similar in the first two test cases, partial scram and pump coastdown. In both cases the response in fission power is slower in the coupled code than in the reference TRAB-3D. In the pump coastdown case both codes have used their own pump models and these have to be compared against each other.

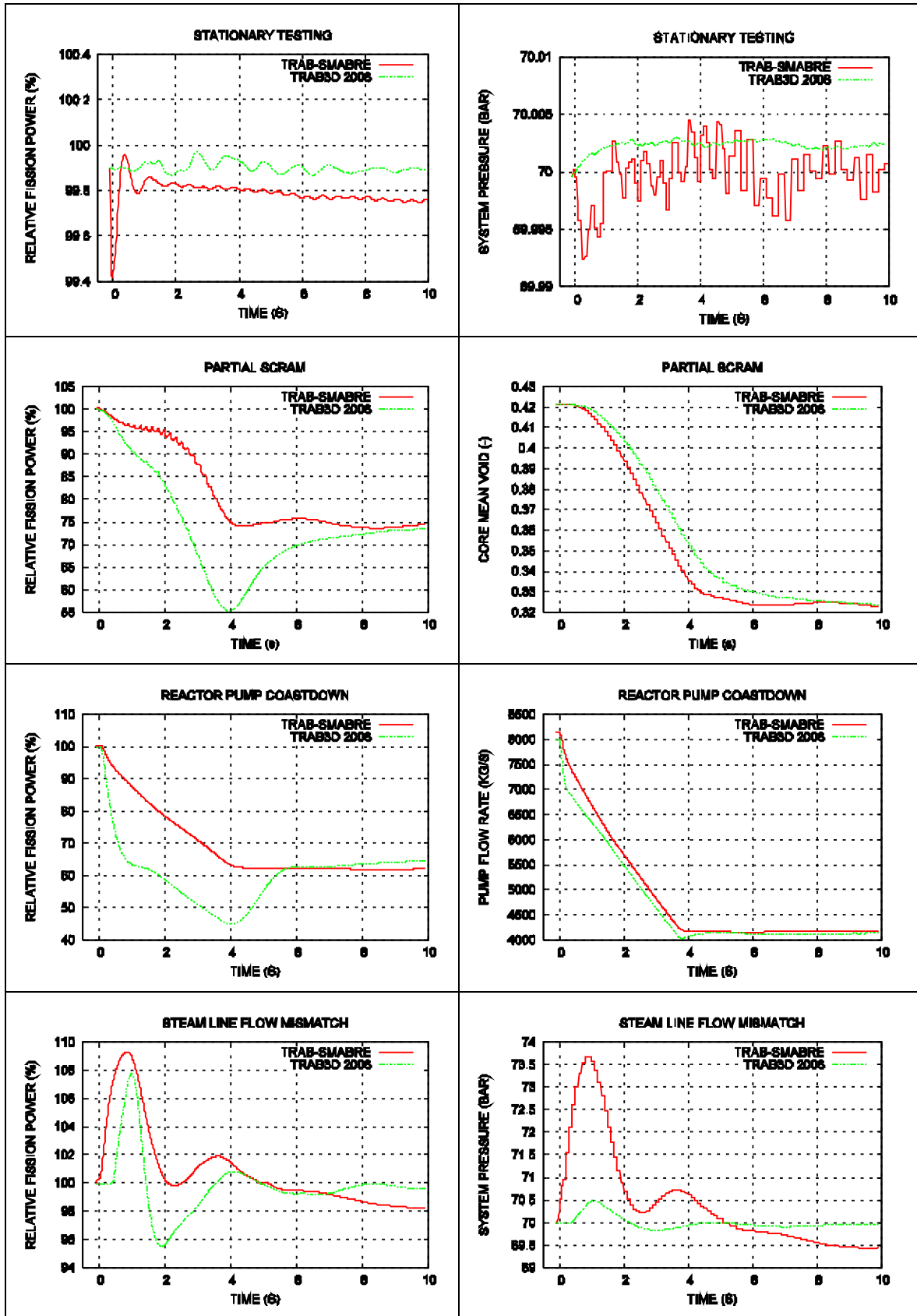

Figure 18. The results from the dynamic testing.

In the steam line flow disturbance the results are again qualitatively similar in both codes, but the pressure response calculated by TRAB-SMABRE is 5 times the response by TRAB. Both codes have used their own models for the steam lines and steam dome, and the modelling needs to be compared in order to clarify the differences in their results.

For calculation of BWR transients the dynamics of the coupled code will need to be studied further and the circuit modelling as well as the dynamics calculation procedure supplemented where necessary.

All the tests have been carried out with a BWR test case so far, which has been more of a challenge to the code thermal hydraulics. On the other hand the test cases allowed identifying needs for remodelling and revealed code shortcomings and errors, which would have been difficult to notice with less challenging test cases. Next step with the coupled code will be testing of a PWR (EPR) model.

Conclusions

The three-dimensional TRAB-3D core dynamics code has been successfully coupled to the thermal hydraulics system code SMABRE, and a satisfactorily working steady state solution has been achieved. The coupling has been more laborious than could be foreseen, due to the inherently coupled nature of the physical processes and the different solution philosophies of the two codes.

The coupling has been carried out in a platform, which includes a lot of improvements into the user interface. This has allowed making detailed comparison between different code versions and coupling modes with a vastly reduced need of manual intervention compared to earlier methods.

Accuracy of the steady state calculation with the coupled code is sufficient for BWR and PWR calculation.

Dynamic testing with single disturbances in a BWR test case shows qualitatively similar results with the coupled code and the TRAB-3D code, but further study is needed before BWR transients can be calculated. Calculation of PWR (EPR) is not expected to add any major problems to the ones already solved.

Besides solving the flow reversal limitation of the present dynamics models, a successful coupling will allow more realistic modelling of an open core. It will allow new options to couple the core model to other thermal hydraulic system codes, and enable further work to couple core neutronics to a thermal hydraulics porosity type model.

References

1. Kaloinen, E. & Kyrki-Rajamäki, R. TRAB-3D, a New Code for Three-Dimensional Reactor Dynamics. In: 5th International Conference on Nuclear Engineering (ICONE-5). Nice, France, 26–30 May, 1997 [CD-ROM]. New York: the American Society of Mechanical Engineers. Paper ICONE5-2197. ISBN 0-79181-238-3.
2. Miettinen, J. Thermohydraulic model SMABRE for light water reactor simulations, Licentiate's thesis, Helsinki University of Technology, Department of Engineering, Physics and Mathematics, 2000. 151 p.
3. Rajamäki, M. TRAB, a transient analysis program for BWR, Part 1, Principles. Espoo: Technical Research Centre of Finland, 1980. Nuclear Engineering Laboratory, Research Report 45. 101 pp. + app. ISBN 951-38-0916-1.
4. Daavittila, A. & Rätty, H. Reactor physics and dynamics (READY): Validation of TRAB-3D. In: Kyrki-Rajamäki, Riitta & Puska, Eija-Karita (eds.) FINNUS The Finnish Research Programme on Nuclear Power Plant Safety 1999–2002. Final Report. Espoo: Technical Research Centre of Finland. VTT Research Notes 2164. Pp. 127–133. ISBN 951-38-6085-X, 951-38-6086-8.
<http://www.inf.vtt.fi/pdf/tiedotteet/2002/T2164.pdf>.
5. Miettinen, J., Vanttola, T., Daavittila, A. & Rätty, H. The combined thermohydraulics-neutronics code TRAB-SMABRE for 3D plant transient and accident analyses. 12th International Conference on Nuclear Engineering. April 25–29, 2004, Washington D.C., USA. ICONE-12-49452. 7 p.
6. Daavittila, A., Hämäläinen, A. & Kyrki-Rajamäki, R. Effects of secondary circuit modeling on results of PWR MSLB benchmark calculations with new coupled code TRAB-3D/SMABRE. Nuclear Technology, Vol. 142, No. 2, May 2003, pp. 116–123.
7. Cronin, J. T., Smith, K. S. & Ver Planck, D. M. SIMULATE-3 Methodology, Advanced Three-Dimensional two-group Reactor Analysis Code. Studsvik/SOA-95/18.

3. High-burnup upgrades in fuel behaviour modelling (KORU)

3.1 KORU summary report

Seppo Kelppe
VTT

Abstract

The modelling in fuel behaviour codes that are in use at VTT has been subject to extensive upgrading in a number of respects. Major achievements include: 1) Streamlining of the coupling of the advanced thermal hydraulic module GENFLO with successive versions the FRAPTRAN fuel performance code, and vivid application of the tool the Halden Project IFA-650 LOCA test series. 2) Comprehensive renewal and extension of the mechanical modelling in FRAPCON and FRAPTRAN codes. 3) Demonstration of joining two programming cultures, the conventional FORTRAN 77 in the VTT version of the ENIGMA code and a module with an Object-Oriented Programming approach of the IMAGINE code and validation. 4) Recorrelation of the parameters of the fission gas model in the ENIGMA code with data from 108 measurements. 5) Basis for a probabilistic procedure to fuel accident behaviour analyses. 6) Favourable progress in education and training of a new generation of experts.

Introduction

Goal for this development work has been to create and maintain an up-to-date selection of methods that provide VTT and its customers – STUK and the nuclear utilities Fortum and TVO in the first place – with an independent ability to carry out a wide spectrum of analyses of fuel thermal-mechanical performance. Emerging new reactor and fuel types and materials, and evolving operational data – higher discharge burnup goals, consideration of various cycle lengths, and other fuel management options – uphold a need for continuous qualification and validation of the separate phenomenon models and their integration. Elaborated acceptance guidelines, as those documented in STUK YVL 6.2 of 1999, are being gradually applied with the renewal of the operation licences of the existing plants, and in full effect with the licensing of new reactors. This calls for access to sophisticated mechanistic, preferably probabilistic calculation methods.

VTT maintains and develops mainly four fuel performance codes which have been once acquired on collaborative or half commercial bases and which have been quite extensively modified and adapted over the years. FRAPCON-3 and FRAPTRAN-1.3,

for steady state and transients, respectively, originate from the US Nuclear Regulatory Commission. Another steady state code is a descendant of the British ENIGMA v.5.9b. The SCANAIR code due to the French IRSN is particularly created to cover Reactivity Initiated Accident (RIA) situations. In collaboration with the IRSN, VTT has carried out a major development effort in SCANAIR with funding from the Finnish Utilities and the Finnish Funding Agency for Technology and Innovation (Tekes). The four codes largely cover the desired compilation of phenomena, and can be used in two independent lines. However, shortcomings have been identified in the performance of the codes in the high burnup domain, in mechanical modelling, and in the applicability to core-wide failure assessments.

Detailed knowledge of high-burnup fuel behaviour in steady state, Loss-of-Coolant Accident (LOCA), and RIA conditions are being gained from collaborative programmes. The Finnish utilities, STUK, and VTT are jointly well placed in internationally managed experimental research such as RIA tests in the OECD-IRSN CABRI Water Loop Project, the experiments in the OECD Halden Reactor Project, the OECD-Studsvik Cladding Integrity Project (SCIP), and the work at the US National Laboratories ANL and PNNL and at the Japan Atomic Energy Agency.

Utilities will endeavour to attain high fuel efficiency. Trend towards higher discharge burnups will continue both in the existing Finnish plants and with the fifth reactor being now under construction. It is of high importance that up-to-date independent modelling tools are timely available.

Main objectives

Objectives originally set over the whole programme period included:

- Elaboration and validation of FRAPTRAN-GENFLO – a code with advanced thermal hydraulics combined with detailed fuel description – for versatile applications.
- Introduction of a mechanistically based fission gas release model for the ENIGMA code. More generally, extension of the modelling of the codes to be valid for 55 to 65 MWd/kgU rod burnups is required. Probabilistic methods will be increasingly favoured.
- Acquiring data from international experiments on Loss-of-Coolant and Reactivity Initiated Accidents and on emerging new materials to upgrade the performance models.
- Establishing improved models for mechanical behaviour and failure modes.
- Supporting education and training of a new generation of experts in the field.

FRAPTRAN-GENFLO Development

The combined FRAPTRAN-GENFLO code adapted to describe the Halden Project LOCA test rig IFA-650 has been calibrated and used to support planning of the experiments and to qualify the results by post test analyses. The idea of combined codes was further advanced by creating the GENFLO linkage to the FRAPTRAN version 1.3 with the new FEM mechanics model [1]. The package can be flexibly used with varying detail and combinations. It has become possible to handle large deformations, clad ballooning, for instance, and a frictional fuel-to-clad contact with the new cladding model, Figure 19. The status and some detail of the FRAPTRAN-GENFLO development and validation are presented in a special article in this report.

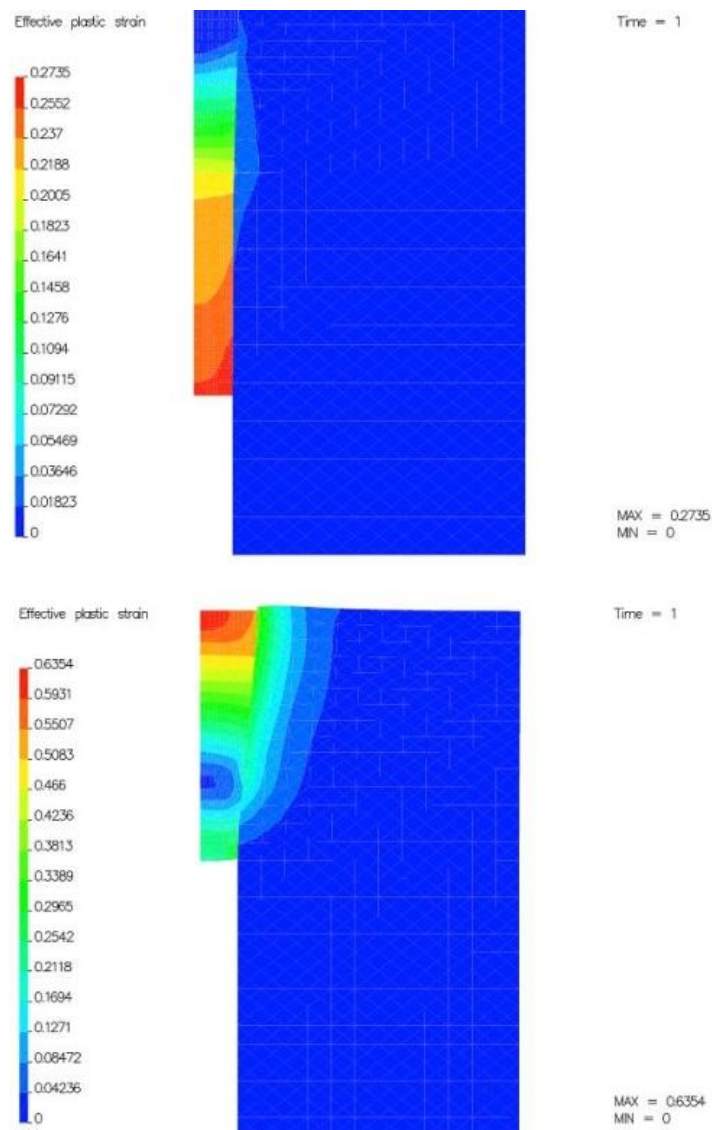

Figure 19. Effective plastic strain distribution in an interference fit problem with friction coefficients of 0.0 (top) and 0.2 (below) (A cylinder of 40 mm in radius forced into a hole of the same initial radius, reducing to 35 mm at 150 mm depth).

Fission Gas Release Model Upgrades

In seeking an improvement in the high burnup performance of the fission gas release model in the ENIGMA code, an exercise was defined of combining a detailed gas description found in external fuel code IMAGINE with ENIGMA [2]. The complication here was that this required merging two generations of modelling techniques. In the IMAGINE code an approach known as object-oriented programming, implemented in FORTRAN 95 language, had been adopted [3]. Some of the basics of this setup are exemplified in Figure 20.

The use of object-oriented programming brings an advantage of significant enhancement in handling the complexity of the codes. This feature has been valuable in the descriptions of fission gas atom and bubble and other porosity within the fuel pellet, Figure 21. The applied modelling included a model for the high burnup structure typically seen on the surface layer of a burnt pellet.

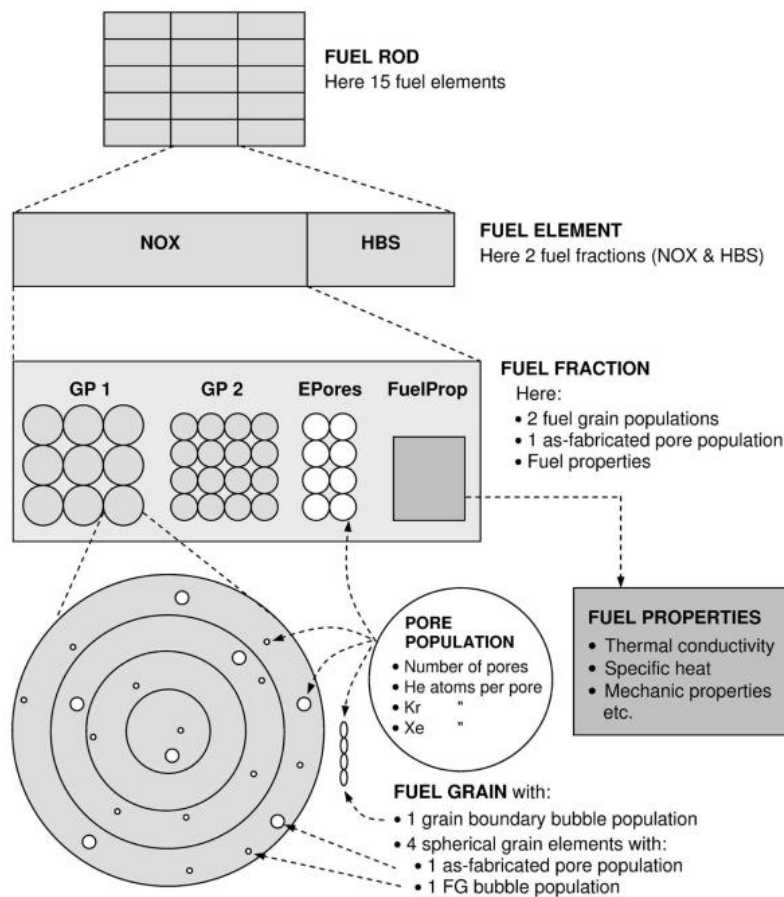

Figure 20. Object-Oriented Modelling. Definition of the Objects in a Fuel Rod.

In several of the cases that were used for the validation of the release model, a certain, yet not impressive, improvement in the predictive capability was noticed, Figure 22.

Nevertheless, the deep-going exercise, also serving as a subject of a diploma thesis, was successful and valuable for future use.

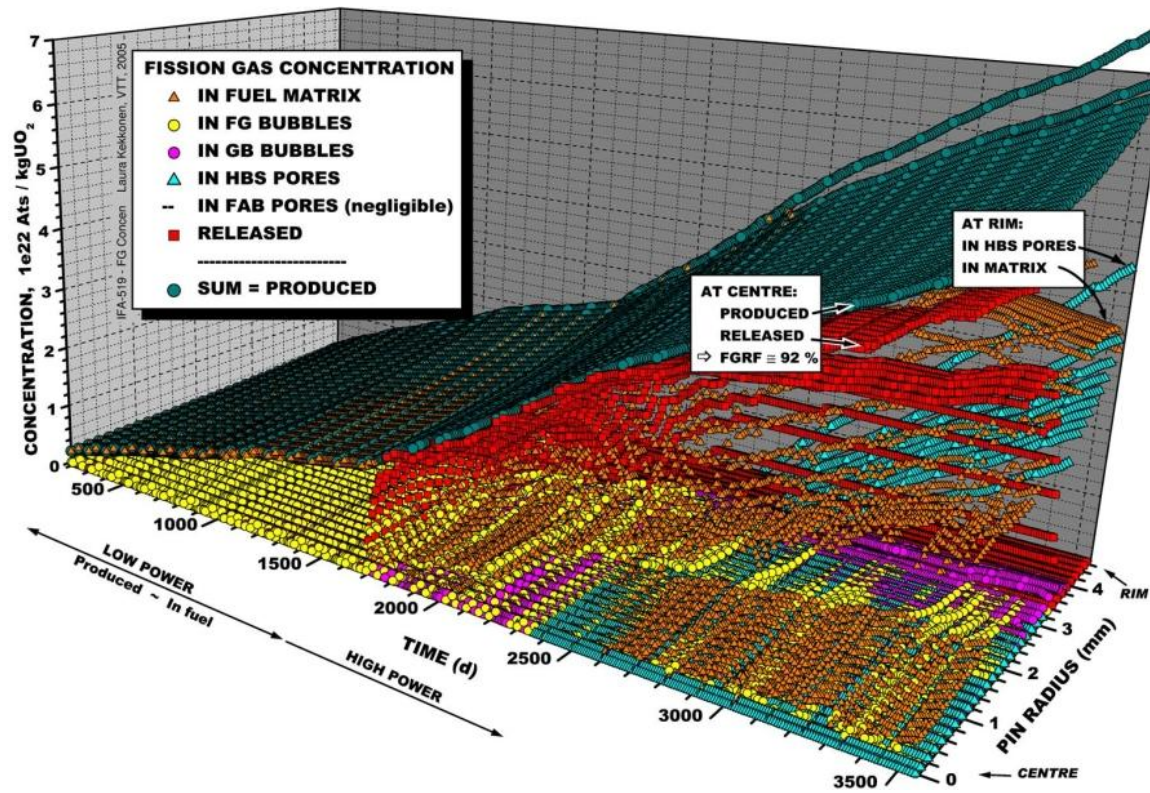

Figure 21. IMAGINE model: Detailed fission gas distribution in a Halden test fuel.

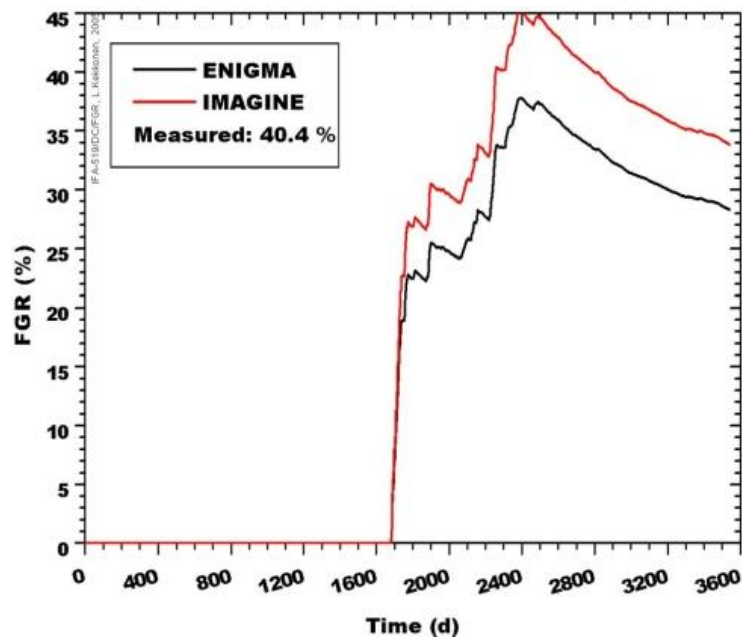

Figure 22. Fission gas release dynamics simulated with ENIGMA and IMAGINE codes.

Yet another approach was taken that relies on recorelation of the model parameters of the ENIGMA fission gas release model. A perl-script was written that can be used to automatically seek an optimized set of the seven applied parameters by repetitive calculations and making use of a least squares method [4]. The fit is done to squared relative differences so as to give enough weight for the cases with only small release fractions. The data used mainly consists of cases in the OECD/NEA IFPE Data Base and here contains 108 data points. Figure 23 presents a comparison of calculated release fractions with those detected. Significant decrease of scatter was realised, and the new parameter selection has been taken into use in power reactor applications.

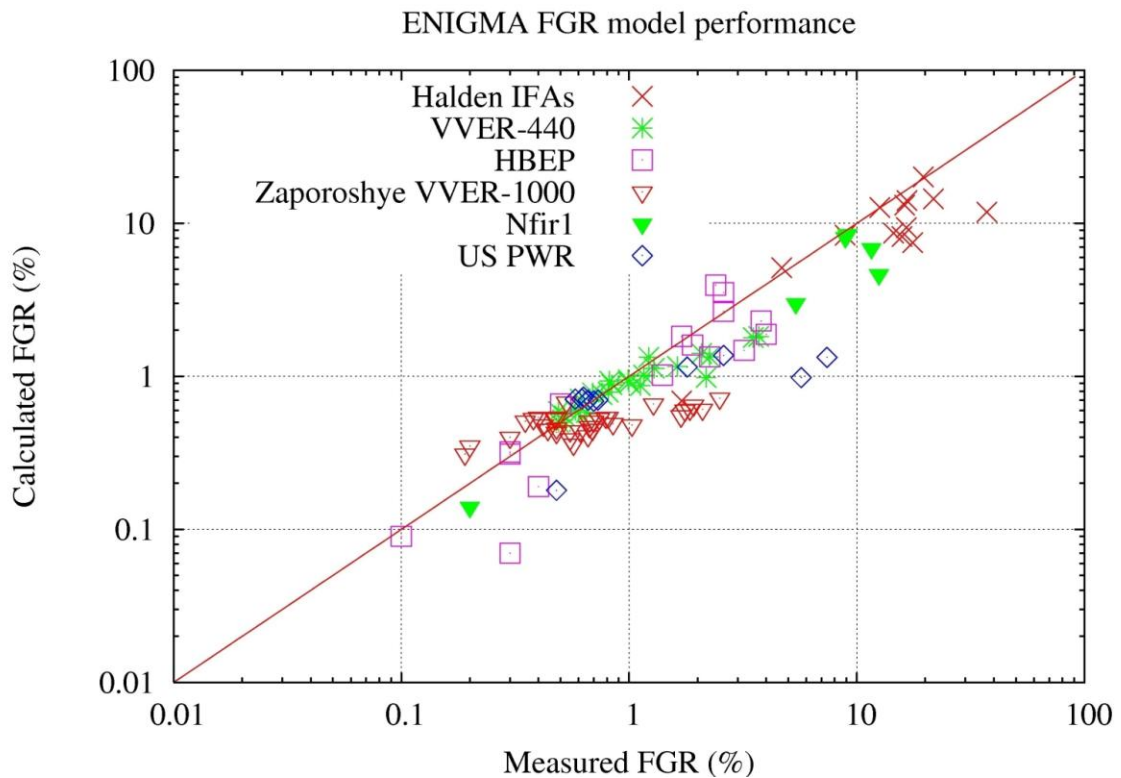

Figure 23. ENIGMA calculated fission gas release in comparison with the measured.

Core-wide assessments and number of failed rods

Statistical methods of varying sophistication are suggested to be used for estimation of the number of rods that might fail in a transient and in determining relative importance of various behaviour factors that contribute to the risk. Such computer code systems for steady state conditions are in effective use at VTT, whereas extension to using these in transient codes for accident scenarios is not a straightforward procedure. A major complication comes from the fact that there are global or whole-core parameters and local parameters that concern a single rod alone.

The procedure to be suggested will start with the definition of the accident and with assessing the related parameter uncertainties, with important grouping of the parameters to global and local categories. After that, it is suggested that one randomly picked selection of global variations will be processed at a time and within each of these the effects of local parameters on the failure rate are evaluated. It has been proven that the maximum number of failures within 59 randomly picked global variations – with purely random selection of local parameters – will actually give the 95% upper limit to the number of failures on a 95% confidence level.

The methodology is being demonstrated in power reactor design basis accident cases. A statistically calculated probability distribution of fission gas release fractions is given as an example in Figure 24.

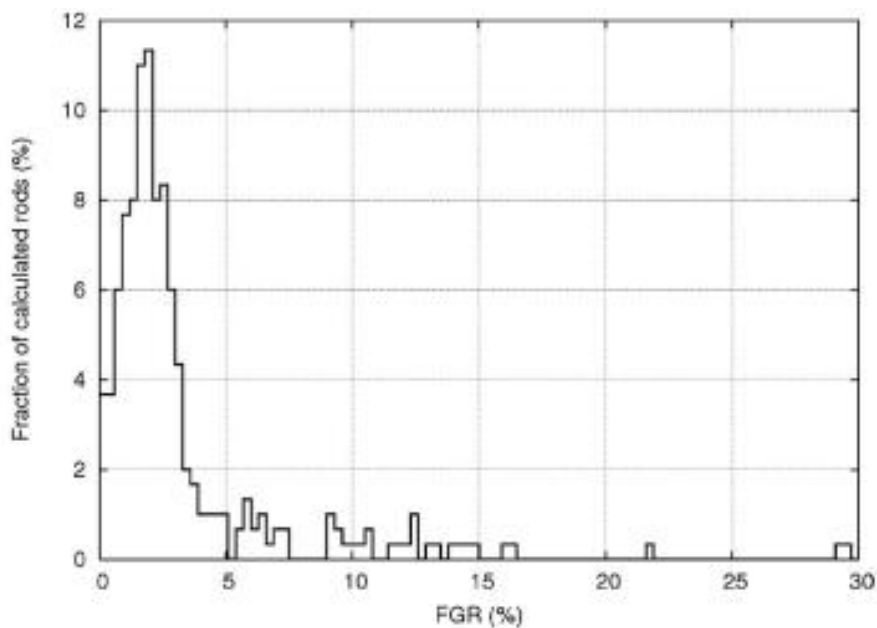

Figure 24. Probability distribution of fission gas release fractions before an accident.

It will be necessary to reduce the number of calculations by making assumptions in conservative direction. It is proposed to start with running 59 global variations more or less routinely. Grouping these by severity of the results may lead to conditions that allow skipping a part of the cases. Yet, it is foreseen that case-by-case judgement with an intelligent mix of conventional analyses and conservative assumptions will be required to curb the number of calculations to a level that is practical to the hardware available.

International connections and education

From the project, participation in the IAEA Technical Working Group on Fuel Performance (TWGFPT) and Technology and OECD/CSNI Special Expert Group on Fuel Safety Margins (SEGFSM) has been actuated. The IAEA Coordinated Research Programme FUMEX II on high-burnup modelling and OECD/SEGFSM Benchmark exercise were attended. In 2003–2004, a VTT scientist worked at the Pacific Northwest Laboratory in Richland, WA, USA, for one year revising mechanical modelling in the USNRC fuel codes. A young worker from the project group is currently attached to the Halden Project for about 18 months. Several occasions of international courses have been attended as a part of training. One licentiate thesis and one MSc diploma thesis were completed in the programme period, formal approvals pending.

Applications

Under contracts, numerous deterministic and probabilistic analyses have been performed for fuel types in operation or under consideration. Spectrum of transient analyses has been widened by making use of the thermal hydraulic capabilities of the FRAPTRAN-GENFLO and VTT APROS codes. FRAPTRAN-GENFLO has been extensively used in planning and qualifying the Halden IFA-650 LOCA test series experiments. Use has also been made of the advanced FEM model in evaluating the clad ballooning in these tests. Under contracts, a set of RIA tests performed in the BIGR reactor capsules in Russia have been analysed with the SCANAIR code, and planning of several tests foreseen to be performed in Halden with high-burnup Loviisa VVER rodlets has been supported by ENIGMA and FRAPCON analyses.

Conclusions

The advanced FEM formulation for the latest versions of the FRAPCON and FRAPTRAN codes together with the coupling of the advanced thermal hydraulic module GENFLO with FRAPTRAN has made the codes and their combinations a versatile tool for power reactor analyses and a flexible research instrument. Elaboration and recorrelation of the ENIGMA fission gas release model parameters produced an improvement in the model performance at high burnups that is satisfactory for the time being. Practical implementation apart, methodology for a probabilistic approach to fuel accident behaviour analyses was created that allows estimating the number failures in a transient. Partly from contract work, a new VVER cladding creep correlation for normal operation, transient heat transfer correlations in SCANAIR for pool cooling conditions in RIA, many properties of new cladding materials, among others, were taken into use in VTT fuel codes. Studies in the course of the programme – the new mechanical formulation, thermal hydraulic considerations, and familiarisation with fission gas and

structural behaviour, in particular – lay good foundations for further development of existing or even completely new fuel models. Education of experts have been supported by international exchange and domestic and international training courses.

References

1. Knuutila, A. Large Strain Deformation Analysis of a Nuclear Fuel Rod. Helsinki University of Technology, Department of Mechanical Engineering. Espoo 18.10.2006. 98 p.
2. Kekkonen, L. Validation of the Fission Gas Release Model of the Advanced IMAGINE Code Implemented in the ENIGMA Fuel Performance Code. Helsinki University of Technology, Department of Engineering Physics and Mathematics. Espoo 20.12.2005. 68 p.
3. Wallin, H. IMAGINE: Advanced nuclear fuel code. Unpublished 2005. Available from the author.
4. Knuutila, A. Recalibration of the ENIGMA Fission Gas Release Model Part1. Research Report VTT-R-05201-06, Technical research Centre of Finland, Espoo, 26.06.2006. 12 p.

3.2 Improvements in transient fuel performance modelling

Arttu Knuutila, Jaakko Miettinen, & Jan-Olof Stengård
VTT

Abstract

VTT employs the fuel transient performance code FRAPTRAN for safety-related analyses of nuclear fuel. Within the High-burnup Upgrades in Fuel Behaviour Modelling research task (KORU), capabilities of FRAPTRAN have been improved by coupling the fuel performance code to an advanced thermal hydraulic model GENFLO. Further, the mechanical modelling in the FRAPTRAN code has been modernized by implementing a new mechanical model for the fuel rod cladding stress-strain analysis. FRAPTRAN-GENFLO and the new mechanical modelling have been successfully validated against the OECD Halden Project LOCA experiments.

Introduction

FRAPTRAN [1] is a transient fuel performance code developed by the US Nuclear Regulatory Commission. The code consists of models that describe the thermal mechanical behaviour of a single LWR fuel rod in transient or accident conditions. The code is used also at VTT for safety-related analyses and as a research tool.

The modelling capabilities of the FRAPTRAN code have been improved at VTT by coupling it with a thermal hydraulic model GENFLO [2, 3], whereby it has become applicable to the non-equilibrium conditions that prevail during the core heat-up and emergency cooling phases of a LOCA. The fuel rod transient behaviour is closely interconnected with the coolant thermal hydraulics, and thus the coupling improves the versatility of FRAPTRAN. In addition to the power reactor transients, the code is now suitable for calculations where the channel thermal hydraulic boundary conditions may be more complicated. An example of such a case is the IFA-650 test rig, which is used in the Halden test reactor for LOCA experiments. The IFA-650 test rig includes several features that are not typical of an ordinary fuel element subchannel in a power reactor and which could not have been modelled with the stand-alone version of FRAPTRAN. The IFA-650 rig includes for example an electric heater for better temperature control in the rig, and a local water spray in the rig to provide further temperature control and a sufficient source of steam for cladding oxidation.

Another major development task to FRAPTRAN at VTT has been the implementation of a new mechanical model in the code. The new mechanical modelling is intended to especially improve the predictions of large localised deformation that may occur as a consequence of a LOCA transient.

The above features have been validated with results from the Halden IFA-650 LOCA test series.

Thermal-hydraulic model GENFLO

FRAPTRAN-GENFLO is a coupled combination of a non-equilibrium thermal hydraulic model and a detailed fuel description. In the thermal hydraulic model GENFLO, the liquid and vapour mass, mixture momentum and liquid and vapour energy (enthalpy) conservation equations are solved for a single flow channel applying 5-equation formalism, where the phase separation is solved in a correlation form using the drift-flux formalism. The primary integration variables are the local pressure, the mass fluxes of the liquid and vapour phases, and the enthalpies of liquid and vapour. The primary variables may be used for deriving the fluid temperature and void fraction (volumetric vapour content) in the fluid. The fluid temperature and heat transfer coefficient from the heat transfer calculation for each axial level at successive time steps can be supplied for the fuel code FRAPTRAN as a boundary condition to the fluid. In parallel, GENFLO integrates its own fuel transient temperature based on the axial power profile. The coupling methodology guarantees the energy conservation and also makes it possible to run GENFLO as a stand-alone code, if the details of fuel behaviour covered by FRAPTRAN are not particularly desired. The stand-alone mode is very efficient especially in parameter variations. In the combined simulation mode, the power history is delivered from FRAPTRAN to GENFLO and FRAPTRAN receives the surface heat transfer coefficients and the local bulk temperature for the heat transfer calculation and the local pressure that is used in the ballooning calculation. The parallel setup of the codes is visualized in Figure 25.

In a generic LWR application, pressure, temperature and flow boundary conditions are provided by a separate calculation with a system code. These can be used as a boundary condition of the independent FRAPTRAN code as well. At VTT the host code may be RELAP5, APROS or TRAB3D-SMABRE.

For analysing the IFA-650 experiment, GENFLO was extended from its original format considering the system according to the LWR vessel type of geometry, for describing even the experimental loop in sufficient detail. These essential details outside the test rig are the long injection line into the rig and the outflow line through the blowdown valves into the blowdown tank defining the pressure boundary condition. The long external

pipelines have a strong contribution to the blowdown characteristics during the first 100 seconds of the experiment.

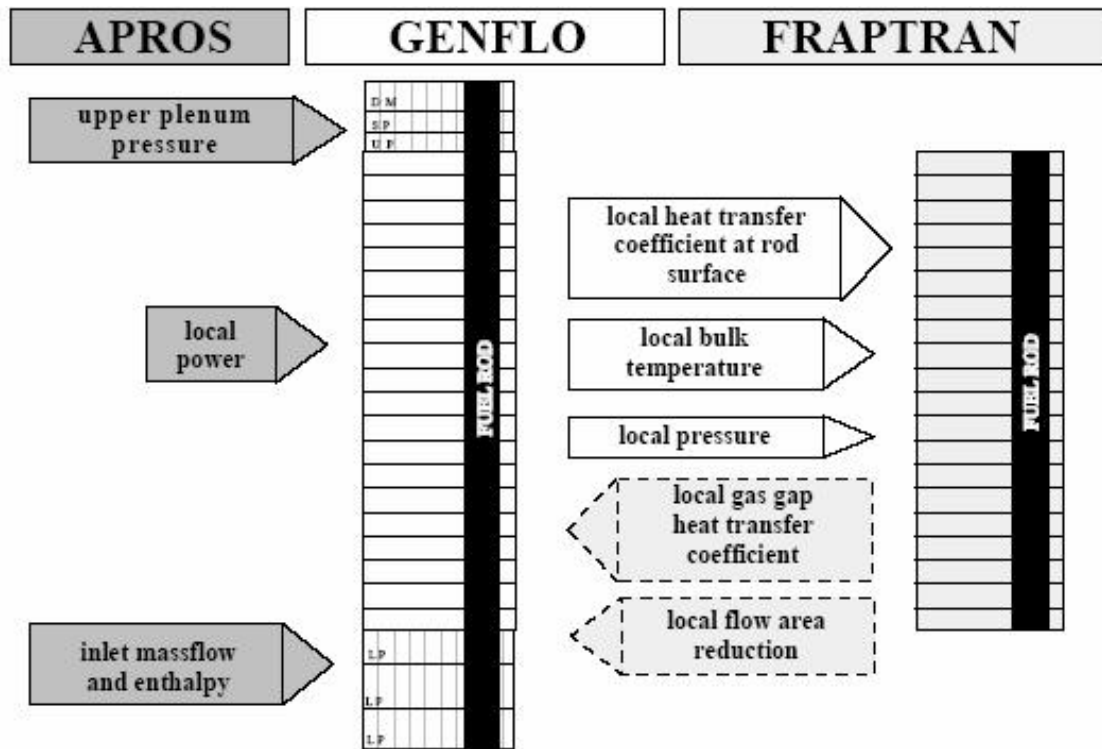

Figure 25. Sub-channel nodalization and data exchange between a system code APROS, GENFLO, and FRAPTRAN (flow area reduction feedback is a future development).

The phase separation model based on the drift flux model includes traditionally two empirical parameters, the average drift flux velocity between phases and the distribution parameter describing the velocity profilization. The coefficients are selected giving the best approach for the bubble flow at low void fraction and vapour- droplet flow at high void fraction. The intermediate region includes a smooth transition form the low relative velocity zone with bubbles to the high relative velocity zone with droplets.

The non-condensable gas field allows describing the hydrogen released during the cladding oxidation.

In LOCA conditions typically, the wall is wetted, when the temperature is below the Leidenfrost temperature, and dry above it. The heat transfer coefficient for the wetted wall is typically defined via correlations for the convective heat transfer from wall to the gas, from the wall to the liquid and for the boiling heat transfer from the wall to the mixture. With subcooled liquid, a factorization is applied for dividing the heat flux into liquid heating and evaporation portions. The heat transfer to the liquid is limited by the critical heat flux correlation. In boiling channels, the main parameter affecting the

critical heat flux is the coolant content, expressed through the void fraction or flow quality. When the void fraction is high enough, the wall heat flux changes into the post-dryout mode, i.e. the surface temperature exceeds the Leidenfrost temperature. In the post-dryout zone, the heat transfer is a combination of the inversed annular film boiling, the convective heating of steam, and – if the surface temperature is high enough – the radiation heat transfer.

Flashing heat transfer is considered as the interfacial heat transfer mode, when the superheated liquid is boiling or the subcooled liquid is condensing vapour. In the post-dryout zone, the evaporation of droplets due to superheated vapour is considered as well.

The radiation heat transfer becomes essential at higher temperatures, typically above 600°C. For the full core simulation, the core is described with axial heat slabs and cylindrically symmetric radial zones. The radial radiation resistivity is defined between the zones. In small scale applications, the core means a single fuel rod. The radiation to external structures, like the heater and the vessel wall in the Halden IFA-650 experiments, is described through view factors defined by the user.

Improvements in FRAPTRAN mechanical modelling

The FRAPTRAN code had a rather simple 1D thin shell model for the stress-strain analysis of the cladding. The model did not show satisfactory performance, e.g. in some LOCA cases. Due to this, a new stress and strain analysis approach with a finite element model [4] was implemented in the FRAPTRAN code. The FE model is based on previous developments at VTT [5]. The finite element model is capable of modelling material nonlinearities such as elastic, thermal, plastic and creep deformations, and geometric nonlinearities such as large localised cladding deformations, e.g. ballooning of the cladding in LOCA. The implemented models are also capable of handling a frictional contact between fuel pellets and cladding. The finite element implementation can mix 1½D and 2D elements in a single FE model of a fuel rod, e.g. 2D elements are used to describe the stress and strain state at the localised region that is undergoing ballooning, and 1½D mesh is used for the rest of the fuel rod to achieve greater computational efficiency, see Figure 26.

IFA-650.2

IFA-650.2 [6, 7] was a LOCA experiment conducted in the Halden test reactor and it is one of the chosen validation cases for FRAPTRAN-GENFLO and the FE model. The experiment goal was to produce cladding ballooning and burst and to achieve a peak cladding temperature of 1000°C. These objectives were met, although the target peak cladding temperature was slightly exceeded in the actual test.

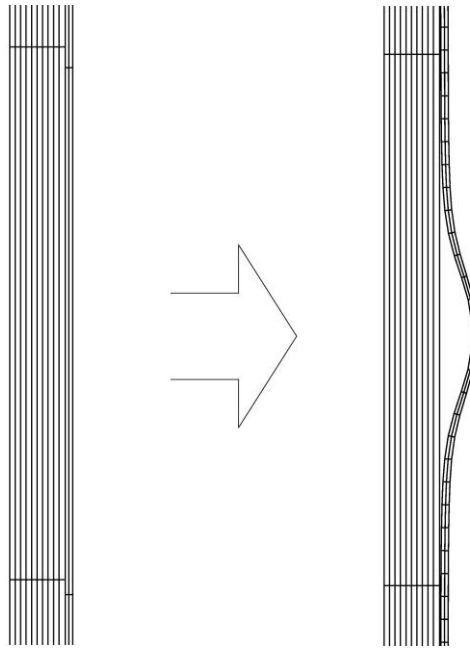

Figure 26. Local mesh refinement from 1/2D to 2D elements for the ballooning region of the cladding in a LOCA type transient simulation.

The test rod was a fresh fuel rod with 50 cm of active length and with the other geometric dimensions similar to a 17x17 PWR fuel rod. The rod fill gas was Helium with an initial fill pressure of 4.0 MPa at room temperature. A high fill pressure was used to ensure the cladding ballooning and burst during the test. The test rod instrumentation included four thermocouples on cladding surface, one (TCC1) at 100 mm elevation from the bottom of the fuel pellet stack and three (TCC2, TCC3, and TCC4) at 400 mm elevation. Also the cladding elongation and rod pressure were measured during the test.

The LOCA case was calculated with FRAPTRAN-GENFLO. The new mechanical modelling was also utilized in the calculation. The validation calculation results of the IFA-650.2 case are shown in Figure 27 – Figure 30. Figure 27 and Figure 28 show the measured and calculated temperatures at the cladding surface thermocouples. The temperatures at the top part of the test rod are quite accurately reproduced by FRAPTRAN-GENFLO. However, the temperatures at the lower thermocouple are somewhat underestimated. The calculated and measured plenum pressure is shown in Figure 29. The burst during the test occurs at 99 seconds. Although the measured plenum pressure is stuck at 5.6 MPa after the burst, the pressure inside the test rod actually equalizes with the rig pressure of 0.3 MPa, i.e., the differences between the measured and predicted values in Figure 29 after the burst are not real. According to Figure 29, the burst time is quite well predicted by FRAPTRAN-GENFLO with the FE model. Figure 30 shows the permanent hoop strains after the LOCA test. The

deformations are quite well predicted at the upper part of the test rod; however, the strains are under predicted at the lower part probably due to temperature underestimation there.

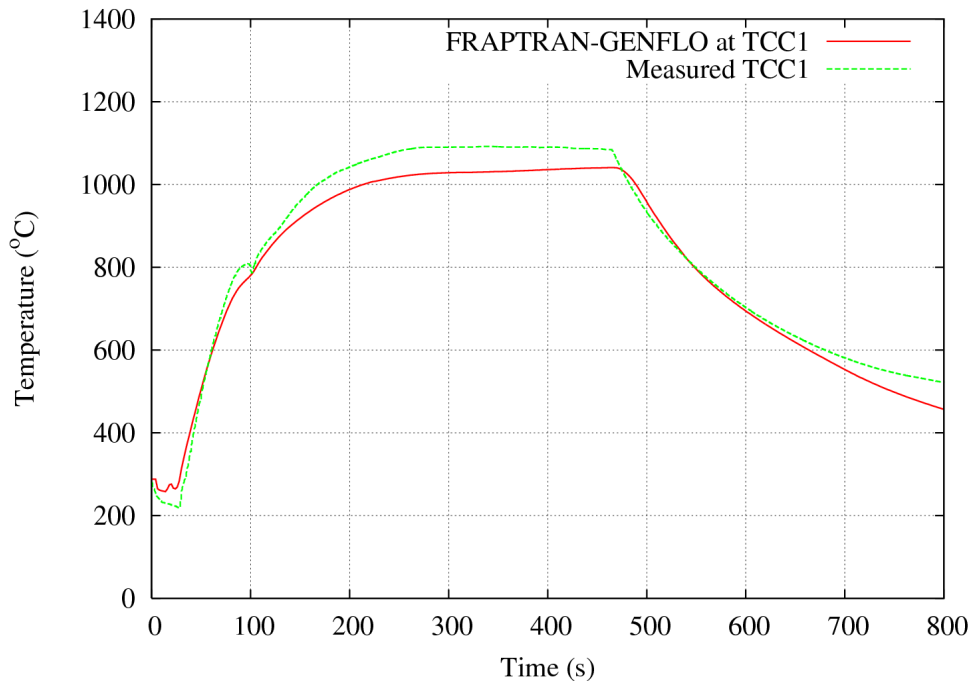

Figure 27. Measured and calculated cladding surface temperatures at the lower part of the IFA-650.2 test rod.

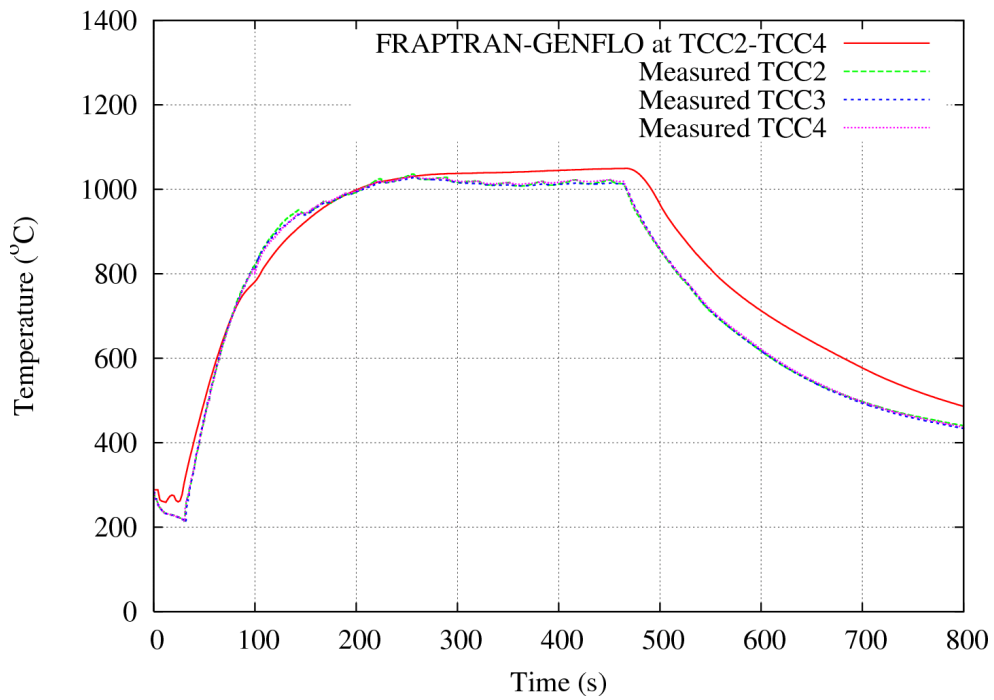

Figure 28. Measured and calculated cladding surface temperatures at the upper part of the IFA-650.2 test rod.

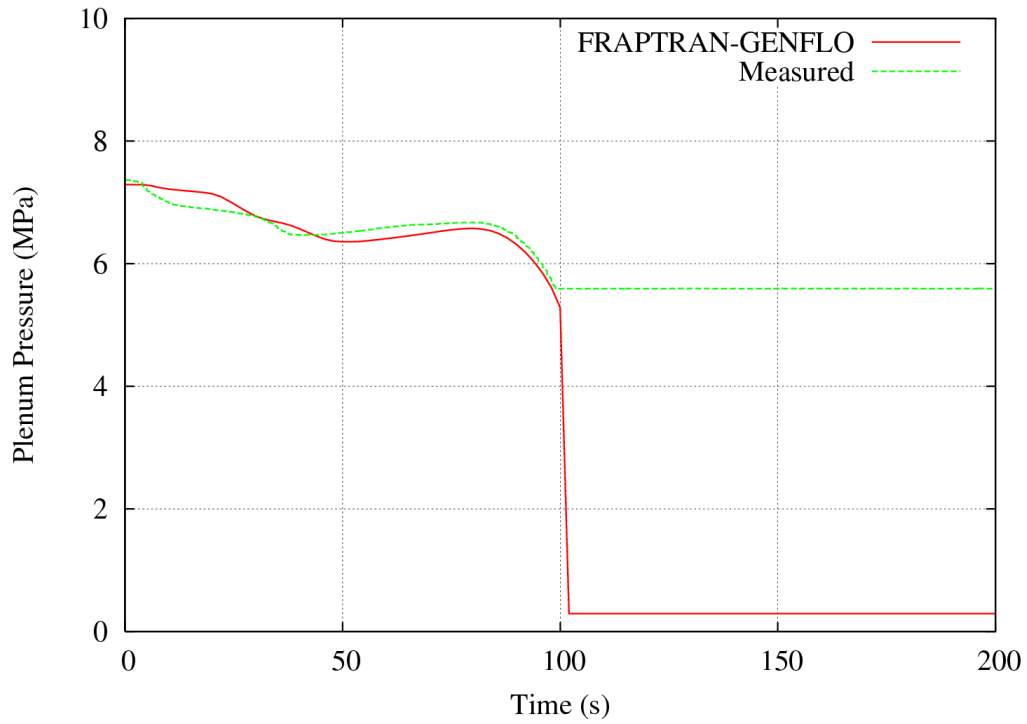

Figure 29. Measured and calculated plenum pressure in the IFA-650.2 test rod.

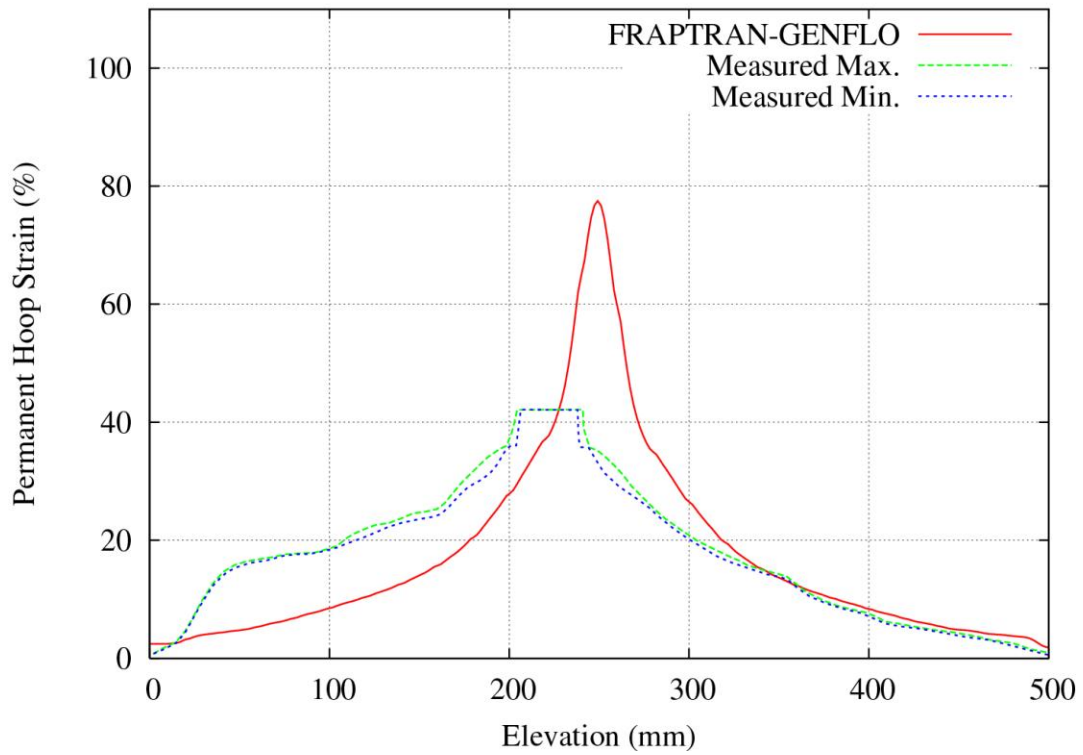

Figure 30. Measured and calculated permanent hoop strain distribution of the IFA-650.2 test rod.

IFA-650.3

IFA-650.3 [8] was a LOCA test with an irradiated PWR fuel rod. The used rod segment had a high burnup of 82 MWd/kgU. Similar 4.0 MPa initial fill pressure of the test rod was used as in the IFA-650.2 test. The target cladding peak temperature was 800°C and it was slightly exceeded during the actual test. The LOCA case was calculated with FRAPTRAN-GENFLO, and the FE model was used for the mechanical modelling.

The measured and calculated temperatures are shown in Figure 31 and Figure 32. The calculated temperature increase starts somewhat earlier than the measured one; otherwise the temperature evolution is quite well predicted by FRAPTRAN-GENFLO. Figure 33 shows the measured and predicted plenum pressure evolution during the test. In IFA-650.3, the test rod started to leak from the weld of the thermocouple before actual burst and thus the predicted burst time is over estimated; however, the pressure evolution is well predicted until the instant of leakage. The PIE results from the test are not yet available and the deformation predictions cannot be compared.

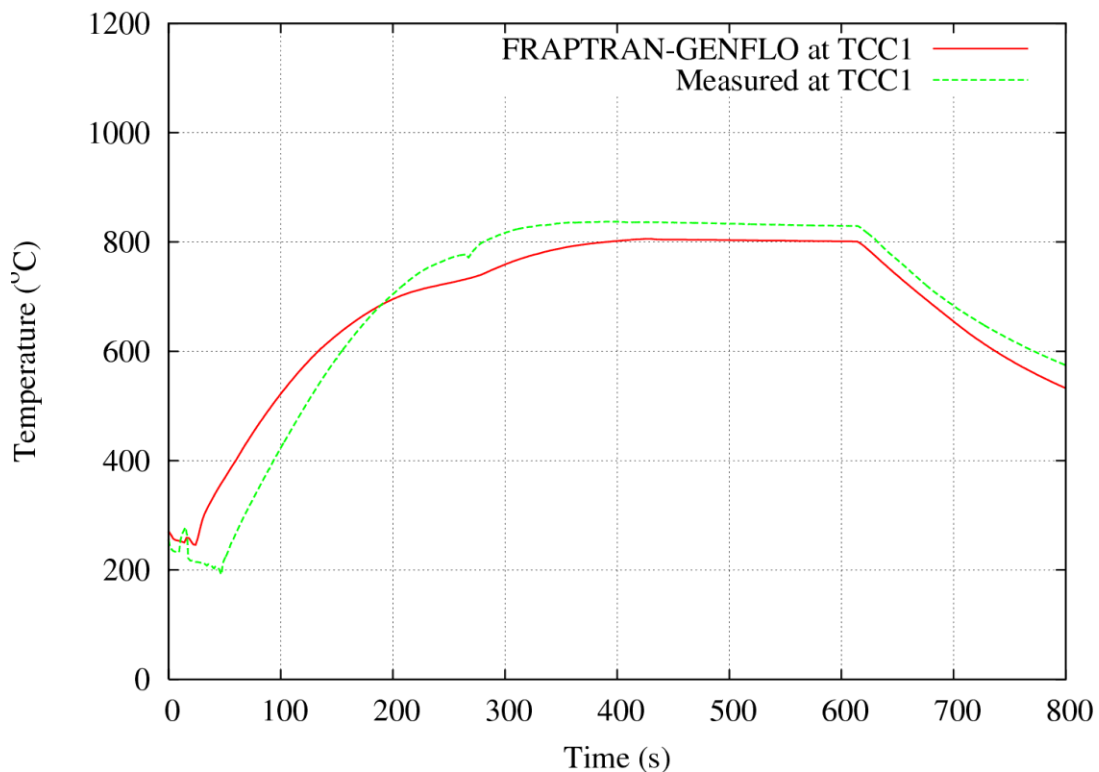

Figure 31. Measured and calculated cladding surface temperatures at the lower part of the IFA-650.3 test rod.

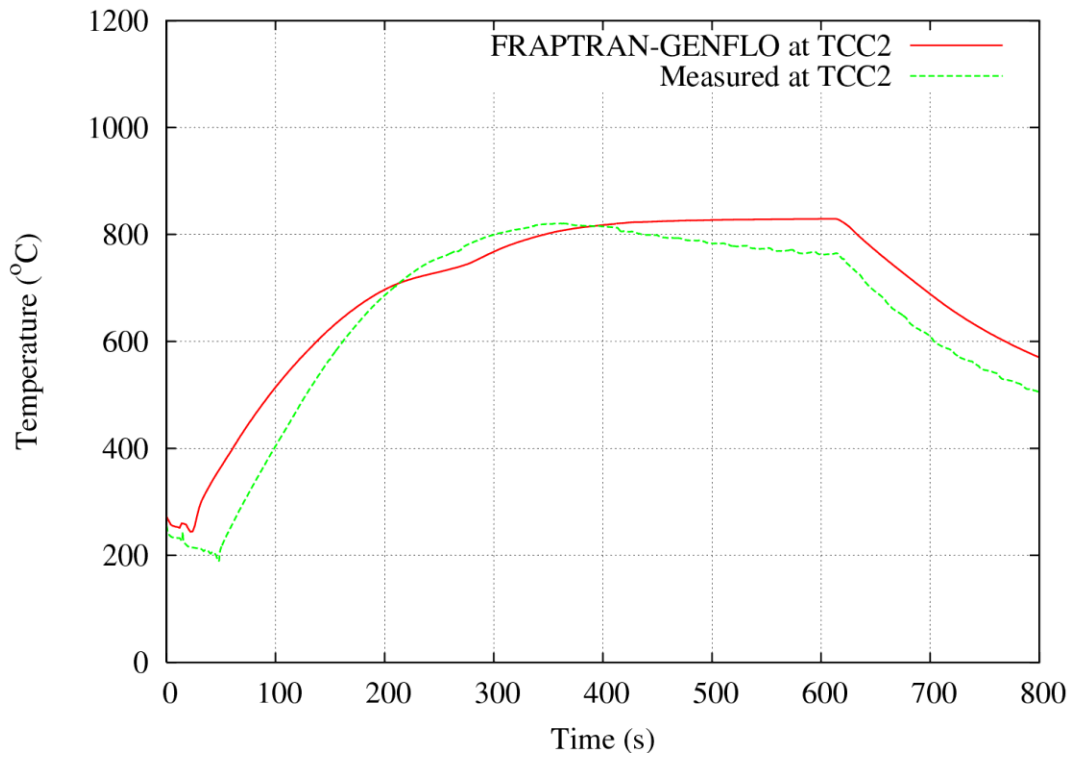

Figure 32. Measured and calculated cladding surface temperatures at the lower part of the IFA-650.3 test rod.

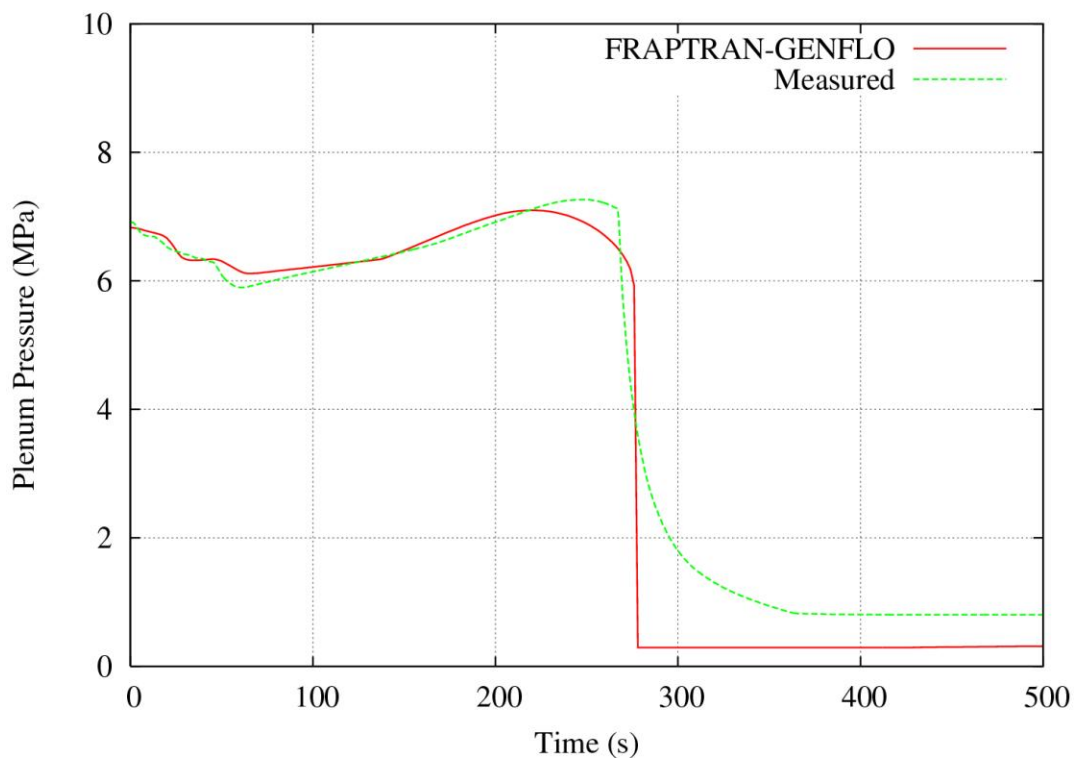

Figure 33. Measured and calculated plenum pressure in the IFA-650.3 test rod.

Conclusions

Significant improvements on the fuel transient behaviour modelling have been achieved by coupling a thermal hydraulic code with a fuel performance code and by new mechanical modelling in a fuel performance code. The coupled code FRAPTRAN-GENFLO and the new mechanical modelling show a good performance in predicting the fuel behaviour in Halden IFA-650 LOCA test series.

References

1. Cunningham, M. E., Beyer, C. E., Medvedev, P. G. & Berna, G. A. FRAPTRAN: A Computer Code for the Transient Analysis of Oxide Fuel Rods. USNRC. NUREG/CR-6739. Vol. 1. August 2001.
2. Miettinen, J. & Hämäläinen, A. GENFLO – A General Thermal Hydraulic Solution for Accident Simulation. VTT Research notes 2163, Espoo 2002. 75 p. + app. 4 p. ISBN 951-38-6083-3. <http://virtual.vtt.fi/inf/pdf/tiedotteet/2002/T2163.pdf>.
3. Hämäläinen, A. Stengård, J.-O. & Miettinen, J. Using GENFLO with FRAPTRAN code. VTT Project Report PRO1/P7015/03, 29.08.2003. 21 p.
4. Knuutila, A. Large Strain Deformation Analysis of a Nuclear Fuel Rod. Helsinki University of Technology, Department of Mechanical Engineering, Licentiate Thesis. November 2006. 98 p.
5. Knuutila, A. Large deformation Analysis Using Finite Element Method NLFEMP. VTT Energy Reports 8/2001. 40 p.
6. Kolstad, E., Wiesenack, W. & Grismanovs, V. LOCA testing at Halden, second in-pile test in IFA-650.2. Nuclear Safety Research Conference. Washington DC. October 2004.
7. Kolstad, E., Wiesenack, W., Grismanovs, V. & Oberlander, B. LOCA testing at Halden-Second in-pile test and preliminary PIE. NFS meeting in Tokyo. March 2005.
8. Aounallah, Y., Khvostov, G., Romano, A., Wallin, H., Zimmermann, M. A., Kolstad, E., Ek, M. & Kekkonen, L. Simulations of the Halden IFA-650.3/4 High Burnup LOCA Tests with TRACE and FALCON: A Preliminary Study on Axial Relocation. Topfuel 2006 Transactions. Pp. 299–305.

4. Integrity and life time of reactor circuits (INTELI)

4.1 INTELI summary report

Pentti Kauppinen, Matti Sarkimo, Antti Timperi & Petri Kinnunen
VTT

Abstract

The research in three new technological areas aiming to the improvement of structural safety of mechanical components and pipings is presented. These are primarily applied to primary piping but the same approach can be applied to other components as well. Computer simulation of ultrasonic inspection can be applied to all components where ultrasonic inspection is used to evaluate the structural integrity and high reliability of inspection is expected. Simulation is an important tool of inspection qualification and its importance is still growing when moving to risk-based inservice inspection programmes. The two other areas presented here are research on fluid – structure interaction and water chemistry interaction.

Introduction

The integrity of the reactor circuit is of outmost importance both in the reactors being currently in operation and in the possible new reactors. The experience gained in operation of existing plants has revealed many loading mechanisms and ageing phenomena that have not been taken into account in the design of the plant. In order to be able to simulate reliably the behaviour of the piping during operation the loading conditions, material and geometrical data as well as the environmental factors have to be known and modelled with sufficient accuracy. In a pressurized component the possibility of fracture has to be considered in the design and it has to be verified that a crack in the wall can be detected in time and the necessary corrective actions can be started.

In INTELI-project several new approaches and technologies to improve the structural safety of mechanical components and pipings were studied. From these three selected areas of research are presented here and the main results achieved in these areas during the SAFIR Programme are summarized. The selected areas are:

- Computer simulation of ultrasonic testing
- Fluid-structure interaction analysis
- Corrosion – water chemistry interaction.

Computer simulation of ultrasonic testing

The applicability of a computer program developed for simulation and modelling of ultrasonic testing has been studied. The aim of the work was to assess the possibilities to apply computer program to simulate the inspection performed at site. By applying simulation at some parts of experimental measurements necessary in the qualification of the inspection system could be avoided. Normally, the inspection qualification is made by using several test blocks representing the real inspection object and the possible defects in it. If the component to be inspected has a complicated geometry the production of test blocks containing intended defects is very expensive and considerable savings could be achieved by applying computer simulation. The performance of different inspection systems can be assessed by varying the inspection approach and the defect parameters, locations, orientations etc. in computer modelling.

The versatile program modules of CIVA software can be applied to model sound field produced by an ultrasonic transducer and to simulate the response from different reflectors hit by ultrasonic sound beam during an inspection.

By the CIVA_US -program module the ultrasonic sound field can be computed and analysed. Figure 34 is showing examples of sound field simulations for two similar transducers with operating frequencies of 2 MHz and 4 MHz. The change in the sound field shape and extension because of the different operating frequency can be noticed. The characteristics of the simulated transducers have been chosen according to real dimensions and properties of two commonly applied real transducers.

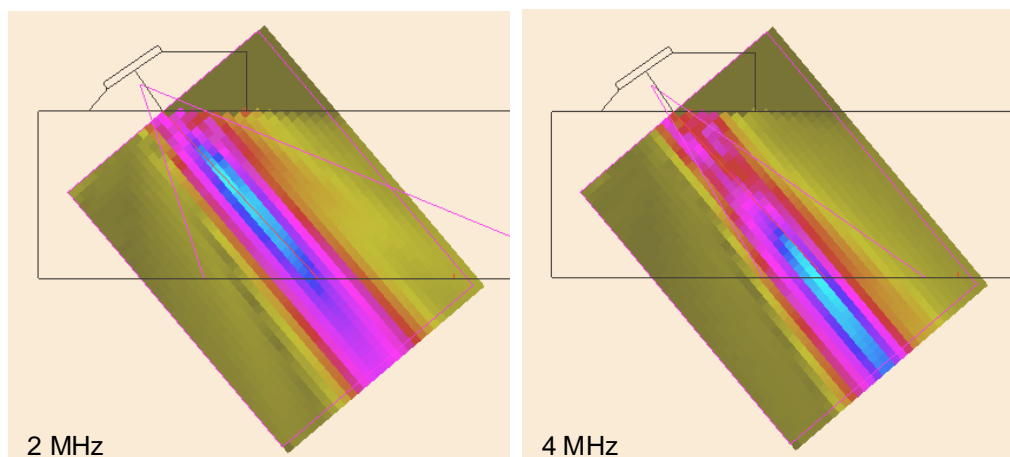

Figure 34. Computed sound pressure distribution of 2 MHz and 4 MHz transducers. The material thickness shown in the figure is 20 mm.

A study where the reflector orientation and size were changed has been performed. The size (height), tilt and skew angle of the reflector has been varied and the signal response

received has been computed using the simulation program. The two transducer field models shown above were applied. The Figure 35 below shows an example how the reflector tilt angle is influencing to the echo amplitude in the simulation.

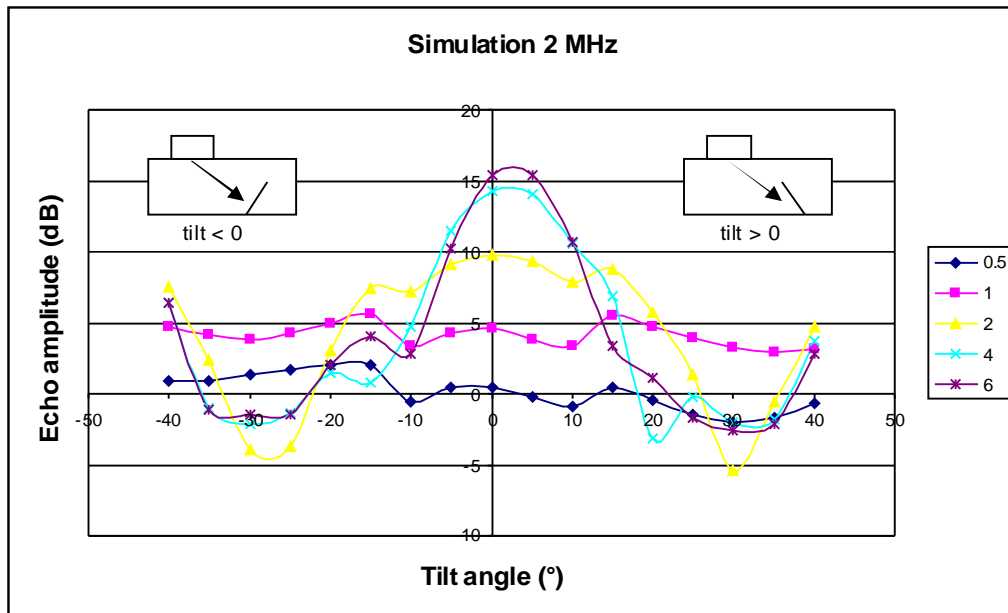

Figure 35. The echo amplitudes at different tilt angles evaluated from simulation results when applying 2 MHz / 45° transducer. Applied reflector heights are 0.5 mm, 1 mm, 2 mm, 4 mm and 6 mm [1].

The known influence of tilt angle variation on the corner trap ultrasonic signal could well be simulated by the CIVA software. The simulation results were also compared with the values from comparable real experimental measurement. The conclusion from the comparison was that the overall agreement between the simulation and experimental measurement results was good. However in some cases noticeable echo amplitude differences could be seen [1].

Fluid-structure interaction analysis

Fluid-structure interactions (FSI) have been investigated for the POOLEX tests conducted at Lappeenranta University of Technology, where air and steam are injected into a water pool. The work consists of three subtasks. First, coupling of the Computational Fluid Dynamics (CFD) and structural analysis codes has been investigated by using the ES-FSI and MpCCI middleware for coupling. Second, modelling of water and steam has been investigated with homogeneous two-phase model and with Volume Of Fluid (VOF) model. Third, determination of loads on the pool walls from the potential theory of fluid flow has been investigated by using the Method of Images (MOI) and other methods.

Fluid-structure interactions

Fluid-structure interactions have been analysed by using various solutions for coupling commercial CFD and structural analysis codes. One-way coupled calculations, in which only the pressure is transferred to the structure, were first carried out with an in-house code. Later commercial codes ES-FSI and MpCCI have been used for analysing also two-way FSI, in which the deformations of the structure are accounted for in the flow solution. In the FSI calculations of the POOLEX experiments, pressure loads caused by the injection of steam have been modelled by using two different approaches. A rapidly condensing steam bubble has been modelled with a single-phase calculation, where the condensing bubble is modelled with a mass sink. In addition, the VOF models of CFD codes Fluent and Star-CD have been used for two-phase (free surface) calculations.

Earlier in the subproject, the internal coupling library ES-FSI of Star-CD was used for two-way coupled calculations with structural analysis code ABAQUS. The mass, damping and stiffness matrices of the structure were first calculated by substructure analysis in ABAQUS. These matrices were then used by ES-FSI to solve the deformations of the structure during the CFD calculation. ES-FSI was suitable for modelling linear elastic structures.

Later, the MpCCI code has been used for coupling ABAQUS with Fluent and Star-CD. MpCCI is more flexible compared to ES-FSI as it allows coupling between different codes and nearly full capabilities of the coupled codes, e.g. using a non-linear structural model. Different interpolation and coupling schemes as well as calculation of thermal FSI are also supported. FSI calculations for simple test models and for the POOLEX facility have been carried out. The one-way fluid-structure coupling can now be routinely used for analyzing behavior of structures under pressure loads. The two-way coupling can currently be used only for certain types of cases due to numerical instability.

The two-way coupled calculations of the POOLEX facility have been numerically unstable due to the explicit coupling scheme used by MpCCI. The main parameters influencing the stability are the compressibility of the fluid and the density ratio $\rho_{\text{structure}} / \rho_{\text{fluid}}$, both of which decrease will decrease stability. The effect of the compressibility is quite restrictive since in many cases it is necessary to model the fluid as incompressible. Two-way coupled analyses with compressible water have been successfully performed with MpCCI in the MULTIPHYSICS project of the SAFIR programme. The instability can be cured by using an implicit coupling scheme where the dynamic equilibrium of the coupled system is searched iteratively in every time step. A flow chart of the explicit and implicit calculations is shown in Figure 36.

As can be seen from Figure 36, the implicit scheme differs only slightly from the explicit one. From a practical point of view, however, at least one difficulty exists: calculation of each time step has to be repeated several times in both codes due to the iteration. In other words, the calculation in both codes would have to be initialised to the converged state of the previous time step after each coupling step. Another possibility might be to allow data transfer and boundary condition update between each implicit iteration performed by the coupled codes inside a time step. These solutions are not supported in the current versions of the codes and, on the other hand, they are difficult to implement without access to the source codes. The need for an implicit coupling scheme is widely recognised and vendors of commercial codes will expectedly implement an implicit scheme in their codes in forthcoming years.

Coupled FSI analyses of various cases were also carried out by using the coupled acoustic-structural capability of ABAQUS. In this method, fluid is modelled with acoustic elements and pressures and displacements are coupled on the fluid-structure interface. Coupled eigenmodes of simple two- and three-dimensional test models were calculated and the results were verified against analytical and experimental results. Coupled eigenmodes of the POOLEX facility were also calculated and a brief comparison to the experiments was carried out. It was concluded that the coupled acoustic-structural approach can be used for calculating the coupled eigenmodes of pressure suppression pools as well as for analysing two-way FSI phenomena which include water hammers [2, 3].

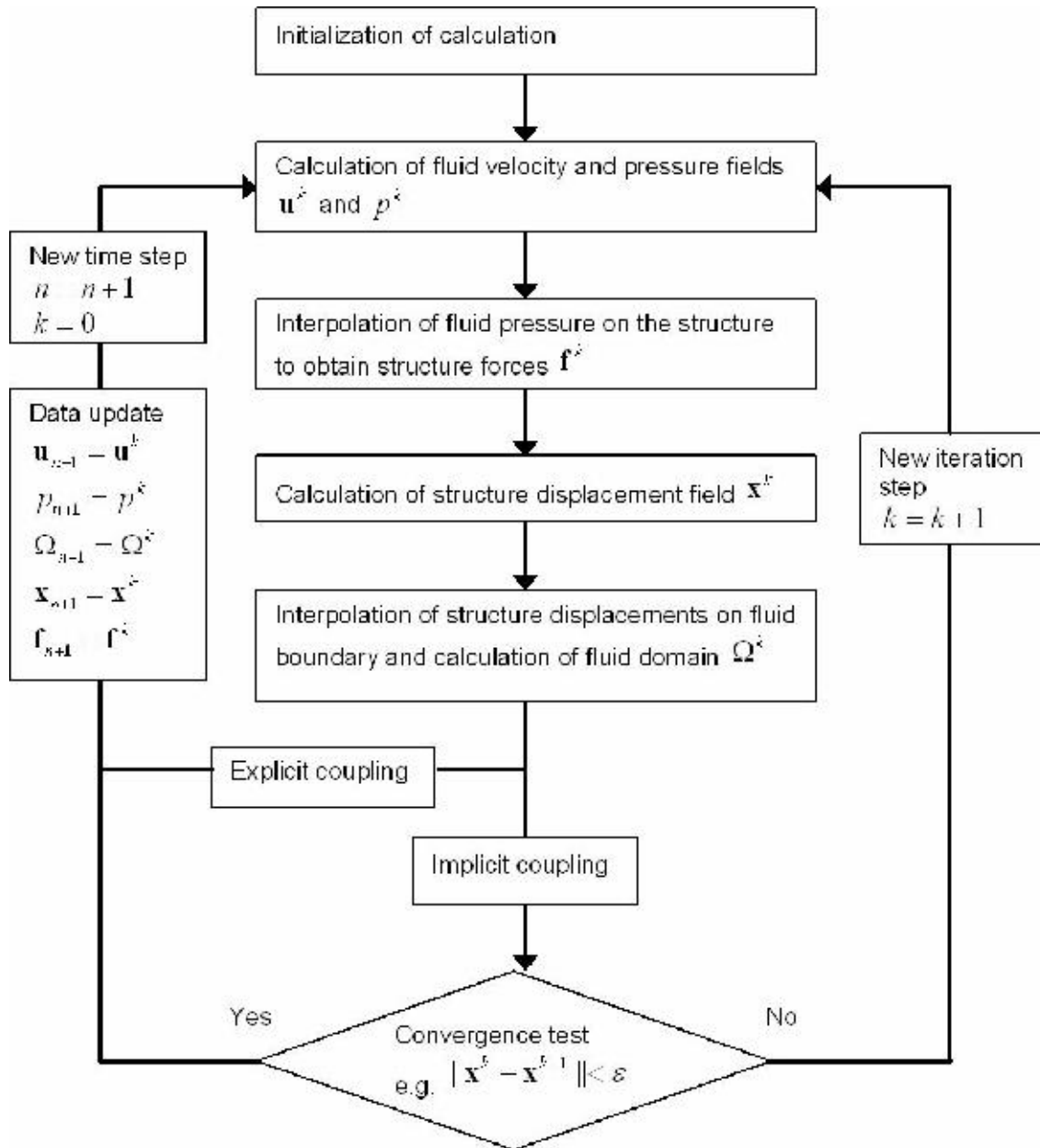

Figure 36. Explicit and implicit fluid-structure coupling.

Two-phase modeling of water and steam

In order to simulate evaporation and condensation phenomena, a homogeneous two-phase fluid model was first implemented in the Star-CD CFD code. In the model, all material properties, such as void fraction, density, temperature, viscosity etc., are defined as functions of fluid pressure and enthalpy. There is no transport equation for the void fraction because it is determined by pressure and enthalpy. This way all problematic matters of two-phase flow have been included in the material property functions. In consequence, Star-CD has to solve just a single-phase fluid flow problem. The fluid-wall heat transfer has been modelled by using standard models found in the literature.

The homogeneous two-phase fluid model has two difficult properties. Firstly, the temperature – enthalpy relation cannot be inverted in the two-phase region. This causes problems when standard energy equation is in use because the energy equation relies on the $h = c_p T$ relation. The problem has been circumvented by defining a new energy equation where the energy flux is determined in terms of energy gradient. Secondly, the fluid density can vary from pure steam (1 kg/m^3) to pure water (1000 kg/m^3) in the flow domain. This variation depends on pressure. This means that the momentum, continuity and energy equations depend strongly on pressure via density.

The homogeneous two-phase model turned out to be quite unstable in transient simulations. Therefore, a simple direct contact condensation was also implemented in the Volume Of Fluid (VOF) model of Fluent. The VOF method has previously turned out to be useful in simulations, where air is blown into the water pool. In addition, a simple model for condensation on the pipe wall was implemented in Fluent. In modeling condensation, correlations adapted from system code Relap 5 / Mod 3 were used. Figure 37 shows an example of instantaneous volume fraction of steam calculated for the POOLEX facility by using the direct contact condensation model.

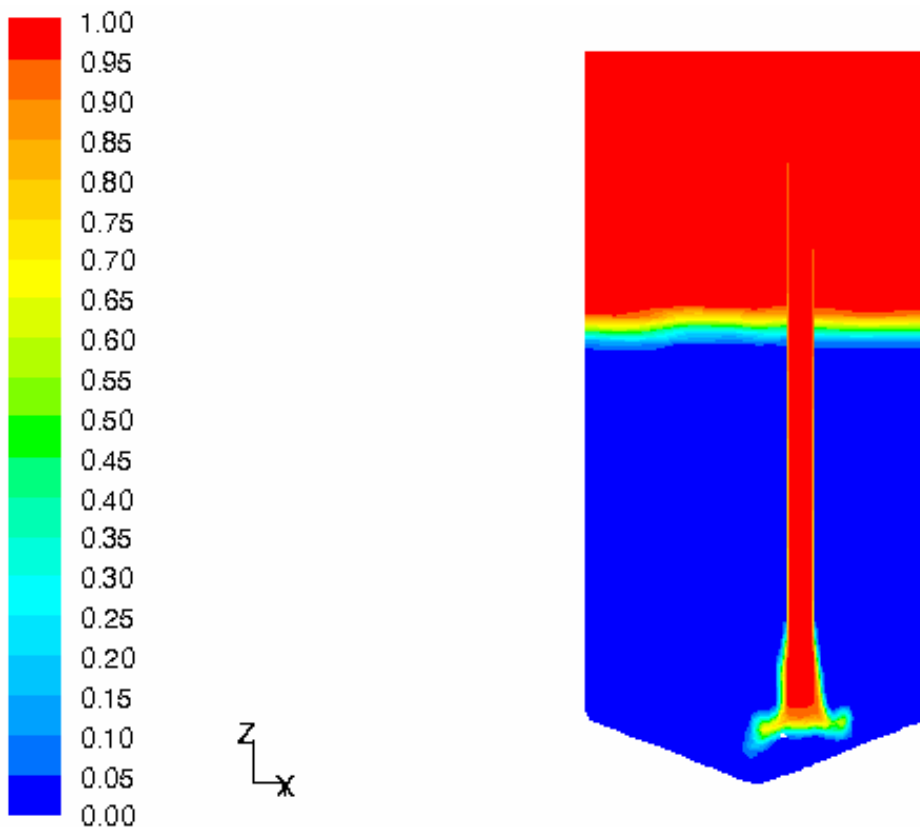

Figure 37. Blowdown of steam into a water pool. Volume fraction of steam at time $t = 1.05 \text{ s}$ is shown in a test run of the condensation model implemented in the VOF model of Fluent. Mass flow rate of steam was 0.36 kg/s and the steam temperature was 100°C .

Implementation of the direct contact condensation model in the VOF model of Fluent is quite stable and promising. The condensation rate of steam at the pipe outlet is, however, clearly slower in the simulations than in the POOLEX experiments. Therefore, improvement of the model and more test simulations are still needed. In addition, the model for condensation of steam on the pipe wall needs further development [2, 3].

Method of Images

The basic motivation of this subtask was to study methods easier than direct three-dimensional fluid flow calculation to estimate pressure loads on the inner walls of a BWR suppression pool during discharge of steam or air through a vertical pipe into pool water, possibly causing the chugging phenomenon. The chosen approach was to assume potential flow and solve the resulting Poisson equation for pressure. As a numerical solution method, the Method Of Images (MOI) was studied because of its relative simplicity and robustness.

MOI is a technique for solving the Poisson equation for incompressible potential flow:

$$\nabla^2 p(x, y, z) = -\frac{4\pi S(x, y, z)}{r(x, y, z)}, \text{ where} \quad (1)$$

$$r = (x^2 + y^2 + z^2)^{1/2}$$

the boundary conditions are disappearing pressure gradient in the normal direction on the walls and zero pressure at water surface.

An older computer code (moi.f) was converted to run in the current computing environment, and several sample pressure fields for the POOLEX condensation pool were calculated and plotted. The code is an implementation of the MOI to solve the Poisson equation for pressure.

The main question when using the Poisson equation for pressure is how to determine the pressure source S (in Pascal meter, $\text{Pa m} = \text{kg/s}^2$), appearing in the numerator of the MOI formula. S is the total strength of the source of the negative pressure gradient vector field $-\text{grad}(p)$; the pressure due to chugging in pool water generally increases when approaching the steam bubble. Then, S is related to the source term (right-hand side) s of the Poisson equation for pressure in that S is the volume integral of s , which in turn is called source density (in Pa/m^2).

In this subtask, several alternatives for the calculation of the MOI pressure source in chugging were identified. Consideration was also given to the question whether the MOI is the appropriate solution method or not. Also, some literature survey was done and the basic theory was presented on that basis.

The difficult question about the value of pressure source still remains open, although new information on the topic was gathered from various sources. The difficulty can be traced up to knowing the dynamics of a rapidly condensing steam bubble. Anyhow, the question of pressure source as such is independent of MOI, as any method of solving the Poisson equation requires the pressure source.

The other central topic in this subtask concerns the method of calculating pressure loads – starting from the Poisson equation or a less approximative physical setting. At least the following main alternatives can be listed:

1. Analytical by using the appropriate Green's function for the actual geometry.
2. The Method of Images (MOI).
3. A difference method of solving the Poisson equation (SILA code by Eerikäinen).
4. One-phase CFD calculation, modeling the collapsing bubble as a mass sink.
5. Two-phase CFD calculation, detaching from the assumption of potential flow.

Alternatives 1–3 are methods of solving the Poisson equation, resulting from the assumption of potential flow, whereas alternative 5 is the most general approach. As two-phase CFD is not mature yet, results probably cannot be expected in near future. The method of Green's functions may be too complicated for arbitrary situations.

Certainly, the MOI is a serious method for estimation of the pressure loads, as it has been extensively used for that purpose for a long time. But when comparing the MOI and SILA codes, there seem to be several reasons to choose SILA for future pressure load applications [2, 3].

Corrosion – water chemistry interaction

The subproject “Corrosion-water chemistry interaction” of the INTELI/INPUT-project had four main focuses: 1) the modification of the high temperature titration equipment developed in earlier FINNUS-program to reach relevant temperature (288°C) and to maintain constant solution composition in studying the adsorption and surface complexation of species at the oxide film/coolant -interface, 2) to study the effect of strain and strain rate on the behaviour of oxide film and on the initiation of stress corrosion cracking on AISI 316L NG, 3) the development of the channel flow electrode technique to study the effect of hydrodynamics on the dissolution of species and the protective properties of oxide films at different temperatures, pressures and surfaces, 4) in-situ studies and modelling of oxide growth on fuel cladding materials in PWR water. The first two tasks were performed during the first half of the SAFIR programme and have been reported in the SAFIR Interim report. In the second half of the programme the main focus was on tasks 3 and 4.

Development of the channel flow electrode technique

The aim of this subtask was to develop a channel flow electrode (CFE) configuration in order to detect soluble species released during metal corrosion in high-temperature aqueous environments. The detection of soluble species released either as end products or as reaction intermediates is essential when determining corrosion rates and oxidation mechanisms of metals. The detection of the soluble species is also important when considering the modifications of water chemistry conditions in power plants.

The channel flow electrode offers a possibility to study the effect of hydrodynamics on the corrosion of construction materials in environments simulating the real process conditions at power plants. In this electrode configuration the process flow is directed through a cylinder-shaped working electrode, which simulates a piece of pipe in a real process piping. The flow rate of the electrolyte can be controlled to produce the desired hydrodynamic conditions. Species released from the working electrode are transported to a cylinder-shaped detector electrode located in a sequence to the working electrode. As the potential of the detector electrode is changed, soluble species with different oxidation states can be detected. The advantage of the channel flow electrode is that the flow in the pipe resembles the real process situation and the surface of the working electrode is exposed evenly to similar flow conditions.

As an overall conclusion concerning the development of the channel flow electrode technique, it can be stated, that the electrode configuration is fairly well usable especially at temperatures up to ca. 100°C. The measurements in the simulated PWR water at 280°C indicated that the presence of hydrogen is problematic for the perceptivity of the dissolved species. One parameter describing the usability of the double electrode configurations, such as the channel flow electrode, is the collection efficiency. It is a geometrical factor that describes the ratio of the dissolved species from the working electrode to those that can be detected on a second electrode, in this case the glassy carbon electrode. The collection efficiency is defined as the ratio -detector current/working electrode current. The collection efficiency with the used flow rates was calculated to be of the order of 10%. This is a fairly low value compared to those measured previously with conventional ring-disc electrodes (30–40%), that are normally used to detect dissolved species at ambient temperature. And it seems probable that the collection efficiency would be even lower, if the flow rate was increased. Thus the low collection efficiency limits to some extent the usage of this electrode configuration.

The electrode was not extensively tested at real PWR temperatures at this point of the study. In the future, measurements in high temperature environments where hydrogen does not play such an important role need to be performed. Also the collection efficiency should be increased mostly by changing the geometry of the electrodes.

However, the replacement of Pt as the detector material with glassy carbon has turned out to be successful and is a noticeable improvement for the electrode [4, 5].

In-situ studies and modelling of oxide growth on fuel cladding materials in PWR water

There is considerable interest towards understanding the mechanism of oxide film growth and corrosion of zirconium alloys used as fuel cladding materials in nuclear reactors. The tendency towards more severe operating conditions for these construction materials, induced by the need for longer service times and higher fuel burn-ups, has called for a more thorough characterisation of the relationship between the composition and microstructure of the Zr alloys, the oxide growth kinetics and the susceptibility to local corrosion modes. Despite of the fact that there is general agreement on the qualitative picture of the oxidation process of zirconium alloys in high-temperature water, the exact mechanism of conduction through the oxide has remained largely unidentified. It is usually believed that the growth of the oxide proceeds according to the coupled-currents mechanism, in which the transport of oxygen vacancies along the grain boundaries of the already formed zirconia is the rate-limiting step of the overall reaction. It is assumed that reduction of water at the oxide/electrolyte interface supplies electrons for the oxidation of zirconium and that the electronic conduction through the oxide proceeds via easy paths associated with second phase particles, such as $Zr(Fe,Cr)_2$, embedded in the zirconia matrix. The extent of coupling between the electronic and ionic fluxes has remained largely unquantified.

Electrochemical measurements in the in-core area of operating plants would provide valuable information about material behaviour and water chemistry under irradiation. At VTT the step-motor driven controlled-distance electrochemistry (CDE) arrangement has been successfully used to characterise the electrochemical behaviour of materials in low-conductivity solutions corresponding to relevant PWR and BWR conditions. It has also been successfully applied to characterise the corrosion properties of zirconium and fuel cladding materials in high-temperature conditions during pre-transition oxidation. In this work the CDE assembly is used to check whether different water chemistry conditions (normal (2.2 ppm) vs. elevated (5.4 ppm) Li concentration) will have an effect on the oxidation processes. The elevated lithium concentration is necessary in PWRs with high burn-up and longer than 12-month fuel cycles in order to keep the pH of the primary coolant within the optimal range. Elevated lithium concentration combined with local subcooled nucleate boiling accentuated by high burn-up may result in formation of crud onto fuel cladding surfaces and further in the phenomenon called Crud Induced Power Shift (CIPS, previously called AOA) or localised clad corrosion. The exact mechanism of CIPS is not known and several studies in the international nuclear community have been and are being carried out to clarify the relationship between fuel cladding materials, water chemistries and the occurrence of CIPS.

The other goal in the studies performed on fuel cladding materials is to check whether differences in oxidation behaviour between different alloys (namely Zircaloy-4, E110 and M5) can be distinguished already during pre-transition oxidation. If the comparison of corrosion behaviour on these materials could be performed reliably already during the pre-transition oxidation, the number of long-lasting and expensive post-transition oxidation tests could be decreased and resources saved.

The experiments indicated that the oxidation rate really increases as the Li concentration increases already during exposures of ca. one week in simulated PWR conditions at 310°C. The extent of increase, however, depends on the material. At the time of writing this report, not all the analyses have been made and therefore no final results can be presented yet in this paper. This work will be continued in the next SAFIR2010 programme by performing a comparison of the oxidation behaviour between different fuel cladding materials in KOH and LiOH solutions [5–8].

References

1. Sarkimo, M. Comparison of ultrasonic echo amplitudes from computer simulation and experimental measurements when different tilt and skew angles are applied. VTT Research Report BTUO77-051398. 20 p. (INPUT)
2. Pättikangas, T., Timperi, A., Niemi, J. & Narumo, T. 2005. Fluid-structure interaction analysis of a water pool under loading caused by a condensation induced water hammer. VTT Industrial Systems, Research Report BTUO72-051332, Espoo, Finland. 56 p.
3. Timperi, A., Pättikangas, T., Niemi, J. & Ilvonen, M. 2006. Fluid-structure interaction analysis of a water pool under loading caused by steam injection. VTT Industrial Systems, Research Report TUO72-056662, Espoo, Finland. 64 p.
4. Bojinov, M., Kinnunen, P., Saario, T. & Sirkiä, P. Corrosion – water chemistry interaction studies in the INTELI-project in 2004. VTT Research Report BTUO75-041288, 2004. 23 p.
5. Kinnunen, P., Lehtovuori, V. & Saario, T. Corrosion – water chemistry interaction studies in the INTELI-project in 2005. VTT Research Report TUO75-056404, 2005. 28 p.
6. Kinnunen, P., Lehtovuori, V. & Saario, T. In-situ studies and modelling of oxide growth on fuel cladding materials in PWR water – tests with E110. VTT Research Report. (In progress).

7. Kinnunen, P., Lehtovuori, V. & Saario, T. In-situ studies and modelling of oxide growth on fuel cladding materials in PWR water – tests with Zircaloy-4. VTT Research Report. (In progress).
8. Kinnunen, P., Lehtovuori, V. & Saario, T. In-situ studies and modelling of oxide growth on fuel cladding materials in PWR water – tests with M5. VTT Research Report. (In progress).

4.2 Development and application of risk informed in-service inspection analysis procedures

Otso Cronvall, Ilkka Männistö, Jan-Erik Holmberg & Urho Pulkkinen
VTT

Abstract

Characteristics and development of risk informed in-service inspection (RI-ISI) methodology for nuclear piping systems are examined in this report. This involves applying the combination of probabilistic fracture mechanics (PFM) and Markov system analyses, and by refining an existing and commonly applied risk analysis procedure. The applicability of the developed risk matrix approach was examined as a pilot study performed to a piping system in an existing Finnish nuclear power plant (NPP).

Introduction

In order to monitor the condition of the NPP piping systems, they are subjected to in-service inspections (ISI). Inspections are performed during annual outages and only a portion of the piping components is inspected. The purpose of these inspections is to detect the possible degradation of the piping components. The risk of a pipe failure is thus minimised, assuming that corrective actions are taken if potential flaws are detected.

In this report the characteristics and development of risk informed in-service inspection (RI-ISI) methodology for nuclear piping systems are examined. In particular the aim is to develop a more accurate semi-quantitative modification of the qualitative EPRI RI-ISI risk matrix procedure [1]. This is carried out by applying the combination of PFM and Markov system analyses, and by refining the risk analysis procedure itself.

The applicability of the developed semi-quantitative risk matrix approach was examined as a pilot study performed to the Shut-down cooling system 321 of TVO. As there does not exist enough applicable degradation data of the piping system in question to allow the use of statistical methods in quantifying the failure potential, structural reliability methods were resorted to. Probabilistic version of fracture mechanics based analysis code VTTBESIT, developed at VTT, was used to analyse the yearly leak and failure probabilities of a selection of circumferential piping welds. The analysed degradation mechanisms were stress corrosion cracking (SCC) and thermal fatigue induced cracking (in the mixing points).

A Markov system based approach to analyse the degradation potential and risks of the piping components was developed in the project. It includes also the effects of inspections, and thus the capability to analyse various inspection strategies, e.g. fixed vs. random. Besides forming the risk matrix concerning the piping system 321, with the application it was also possible to optimise it.

Through RI-ISI analyses remarkable benefits can be gained. Compared to traditional and conservative ISI approach, RI-ISI allows the energy utilities to optimise their inspection programs, so that the number of inspection locations and consequently the time the inspection team has to spend under radiation can be considerably reduced, while keeping the safety of the piping systems at least on the same level as earlier.

VTT RI-ISI analysis methodology

EPRI (Electric Power Research Institute) has developed a practical approach that allows NPPs to develop RI-ISI programs for piping systems using only in-house personnel. The aim of this approach is to focus the inspections to those parts of a piping system which contribute most to the overall risk level of the plant. For this purpose, risks have to be quantified. The engineering definition of risk is now accepted as being the product of the probability and the consequence of an event. In mathematical terms this simply becomes [2]:

$$R_i = P_i \cdot C_i \quad (1)$$

where: R_i is the risk of event i , P_i is the probability of event i , and C_i is the negative consequence of event i . In various system levels individual contributing risks are usually summed.

The EPRI procedure includes four major steps [1]:

- identification of the system and evaluation of boundaries, including the selection of the piping systems to be inspected
- failure mode and effect analysis (FMEA), in which the potential failure modes of the chosen piping systems are determined and the consequences of the possible pipe rupture are estimated
- division of selected piping systems into separate segments, where a piping segment consists of a continuous pipe run, the components of which have common rupture impacts and degradation/failure modes
- assessment of risk of each pipe segment \Rightarrow based on this pipe segments are divided into categories of high, medium and low risk, using as a risk parameter the

conditional core damage probability (CCDP) for a limiting pipe break size and the probability of a pipe break, where the probability of a pipe break is assessed on the basis of the determined degradation mechanism(s) for each pipe segment.

In addition to the procedure steps described above, the more accurate and refined modification of the qualitative EPRI RI-ISI risk matrix procedure developed at VTT includes [3]:

- changing the degradation category in the risk matrix from qualitative to quantitative
- assessing the piping segment failure probabilities with a PFM based analysis tool developed at VTT, instead of evaluating them roughly based just on operational/process conditions as is done in the EPRI procedure
- assessing and optimising the piping segment risks with a Markov system based analysis tool developed at VTT.

The PFM approach applied in the failure probability analyses is briefly described in the following. As mentioned above, the analysed degradation mechanisms were SCC and thermal fatigue induced cracking in the mixing points.

The probabilistic treatment of some of the crack growth analysis input data parameters is described first in the following. Other crack growth analysis input data parameters than those presented here as probabilistically distributed were considered to have deterministic values.

In general, several of the input data parameters relevant in fracture mechanics analyses have markedly scattered characteristics, which can be observed e.g. from laboratory test results. These include [4]: 1) initial crack dimensions: depth and length, 2) formation frequency of initial cracks, 3) certain material properties: e.g. fracture toughness, tensile stress, and 4) service conditions: e.g. frequencies of load cycles. It is often sufficient from the viewpoint of the quality of probabilistic analysis results to consider only two or three of the most relevant scattered input parameters as distributed [4].

In this study probabilistic distributions were assessed for the following three input data parameters: 1) depth of initial cracks, 2) length of initial cracks, and 3) frequency of thermal loads in mixing points [3].

The assessment of probabilistic distributions for initial crack sizes was based on flaw data from Swedish NPP units, as reported in [5]. Main part of this data was considered as applicable to the piping system examined here. Exponential probabilistic distributions were developed both for the depth and length of the initial cracks [3].

The probabilistic treatment of thermal loads in the mixing points is described in the following. In general, there exist many uncertainties in the estimation of the thermal load cycles in the piping mixing points, which include:

- difficulties and inaccuracies in modelling correctly the turbulent mixing phenomena
- difficulties in defining the heat transfer factors between the fluid and the pipe wall.

A reasonably robust and conservative approach was applied in the assessment of thermal thermal load cycle distributions [3]: 1) the range of the thermal loads was taken as the total temperature difference of the two mixing fluids in cases it was not large, and as slightly decreased in more severe cases, 2) the shape of the load cycles was assumed as sinusoidal, 3) a reasonably conservative value was assumed for the heat transfer coefficient, 4) the thermal stress distributions in the pipe walls were analysed over a sufficiently wide range of load cycle frequencies with an analysis code that applies finite difference method in axially symmetric geometry, 5) of the analysed load cycle frequencies those resulting with highest stress distribution amplitudes were chosen to be used in the following fatigue analyses, and 6) when assessing the yearly number of load cycles the frequencies used for thermal loads were assessed case specifically in relation to so called turn over and transit times and assuming that the distribution of all realistically possible load cycle frequencies is even.

The thermal stress distributions in the pipe walls were analysed with analysis code DIFF which has been developed at VTT, see reference [6]. With DIFF it is possible to analyse the stresses caused by pressurised thermal shocks in straight cylinders.

The probabilistic crack growth analyses were carried out with a modified version of analysis code VTTBESIT, developed by the Fraunhofer-Institut für Werkstoffmechanik (IWM), Germany and by VTT. With the VTTBESIT it is possible to quickly compute the stress intensity factors along the crack front and crack growth [7]. The modifications concerning VTTBESIT and performed within this study deal with the addition of probabilistic capabilities to the code, which is originally intended for deterministic fracture mechanics based crack growth analyses.

The analysis procedure of the probabilistic version of VTTBESIT is as follows [3]:

- reading of the deterministic input data
- random picking of certain input data parameters from the specified distributions:
 - 1) thermal fatigue; probability distributions for initial crack depth, length and for load cycle frequency,
 - 2) SCC; probability distributions for initial crack depth and length

- crack growth analysis: the amount of crack growth in each time step is calculated from the respective crack growth equation \Rightarrow the ending criterion of the analysis is that crack depth reaches the outer pipe surface
- for each analysed circumferential piping weld 5000 separate simulations were calculated, and for each of these values of the above mentioned distributed input data parameters/variables are picked at random from the respective probabilistic distributions
- the degradation state to which the crack has grown is calculated for each year of the estimated time of operation and for each simulation \Rightarrow these results are used in the consequent Markov system probabilistic degradation analyses performed with a Matlab application developed in the project.

The SCC analyses were performed for quasi-static operational conditions, and the thermal fatigue induced crack growth analyses for fluctuating high frequency thermal loads, which were discussed above.

The assessment of piping segment risks with a Markov system based analyses is described in the following.

Markov models are used widely in modelling reliability problems. For an introduction see for example references [8] and [9]. Different discrete states in the Markov model correspond to different configurations of the inspected system. In this application concerning pipe degradation and inspections, these different states correspond to crack growth in the pipe walls. Thickness of the wall is divided as a function of crack depth into states according to detection probabilities and assumed repair policies.

A discrete time Markov procedure was chosen for piping risk analyses. The overall method can be summarised in six steps [3]:

1. Crack growth simulations based on PFM
2. Construction of degradation matrix transition probabilities from PFM simulations and database analysis of crack initiation frequencies
3. Model for inspection quality, which used to construct inspection matrix transition probabilities
4. Markov model to calculate pipe rupture probabilities for chosen inspection schemes
5. Assessment of pipe rupture consequences from plant specific probabilistic safety assessment (PSA)
6. Comparison of results for different inspection strategies. Measures of interest include yearly rupture probability, yearly core damage probability and average values for both over plant lifetime.

The basic discrete time Markov equation is [3]:

$$\bar{p}_t = \bar{p}_{t-1} \times M \quad (2)$$

where \bar{p}_t is probability vector $[p_0 \ p_1 \ p_2 \ p_3 \ p_4 \ p_5]$ the elements of which contain the probability for each system state at time t , and M is the transition matrix that contains the transition probabilities to each state. Due to Markov property the probability vector can be calculated after any number of steps with equation [3]:

$$\bar{p}_t = \bar{p}_0 \times M^T \quad (3)$$

where \bar{p}_0 is the vector containing the probabilities of different degradation states in the initial condition. It is assumed that the probability of detectable flaws or other degradation conditions is initially zero, i.e. the pipe is in as good as new condition. In this study Matrix M is calculated from the results of the PFM simulations. The degradation-inspection process was modelled with two matrices: degradation matrix M_d and inspection matrix M_i .

For example, the different state probabilities for a 3-year interval inspection strategy after 10 years are calculated as:

$$\bar{p}_{10} = \bar{p}_0 \cdot M_d \cdot M_d \cdot M_d \cdot M_i \cdot M_d \cdot M_d \cdot M_d \cdot M_i \cdot M_d \cdot M_d \cdot M_d \cdot M_i \cdot M_d$$

Six Markov states are used in the model in this study, see Table 5.

Table 5. Markov system states [3].

State	Crack depth	Description
0	0	New piping section falls into this category.
1	0–1 mm	Small flaw – very unlikely to detect.
2	1mm-50% of wall thickness	Progressed crack in the segment. Possibility of detection, but no repair.
3	50–99% of wall thickness	Grown crack. Possibility of detection and then segment is repaired.
4	99%–<100%	Leak-before-break. Repaired if detected.
5	100%	Rupture.

The degradation matrix presents the transition probabilities for piping components from different system states to others, while the inspection matrix presents the probabilities of finding piping fractures and leaks in the inspections.

While the Markov model is used to calculate piping rupture frequencies for different inspections strategies, PSA results are used to assess the consequence side of the risk. Risk measure used for pipe ruptures is most commonly conditional core damage probability (CCDP). It is also used in this study.

Risk classification is used in RI-ISI applications to control risks associated with pipe ruptures. The classification is based on both probability and consequences of the pipe rupture. Each piping segment is assigned a risk class according to its risk degradation category and consequence category. The risks are controlled by altering the inspection frequency of the different segments. Thus, the RI-ISI program can only affect the probability/frequency side of the risk equation. Other, more limited measures are available also for controlling the consequence side in plants already in operation. Figure 38 below shows a risk matrix modification, developed by VTT, of the EPRI RI-ISI classifications scheme.

There are two typical goals for using the risk matrix:

1. To identify high-risk cases that need reduction in risk, e.g. to move segments from class A to lower classes
2. To allocate ISI resources in a balanced way. The goal is to have most of the segments in class D.

It should be noted that the risk classification process is an iterative process. Changes to the inspection strategy are planned with the help of the matrix, and then the effects of that strategy are evaluated. This usually alters the classification, which is then used further to adjust the inspections.

Summary of a RI-ISI analysis of an existing Finnish nuclear piping system

The piping system examined in this study is the Shut-down cooling system 321 located in two boiling water reactor (BWR) units OL1 and OL2 of utility TVO.

The most significant degradation mechanisms affecting the system 321 are assumed to be SCC and thermal fatigue in the mixing points. There are eight segments in which either of these degradation mechanisms is assumed to act as the prevailing degradation mechanism. All in all the system 321 is divided to 20 segments. There are also several segments in the system 321 which are assumed to be affected by no degradation mechanism [10].

16 piping welds were chosen to be analysed, twelve of them are SCC cases, and four of them are thermal fatigue cases. They cover all those eight segments which are assumed to be susceptible to thermal fatigue induced cracking or SCC.

		Consequence category				
		None	Low <1E-5	Medium 1E-5 ...1E-4	High >1E-4	
Degradation category	> 1E-4	High	D	C	B	A
	1E-5...1E-4	Medium	E	D	C	B
	<1E-5	Low	E	E	D	C

Keys to risk classes: Red = Very high / unacceptable risk, Orange = High risk, Yellow = Medium risk, Green = Low risk, White = Very low / inconsequential risk

Figure 38. Risk classification developed by VTT [3].

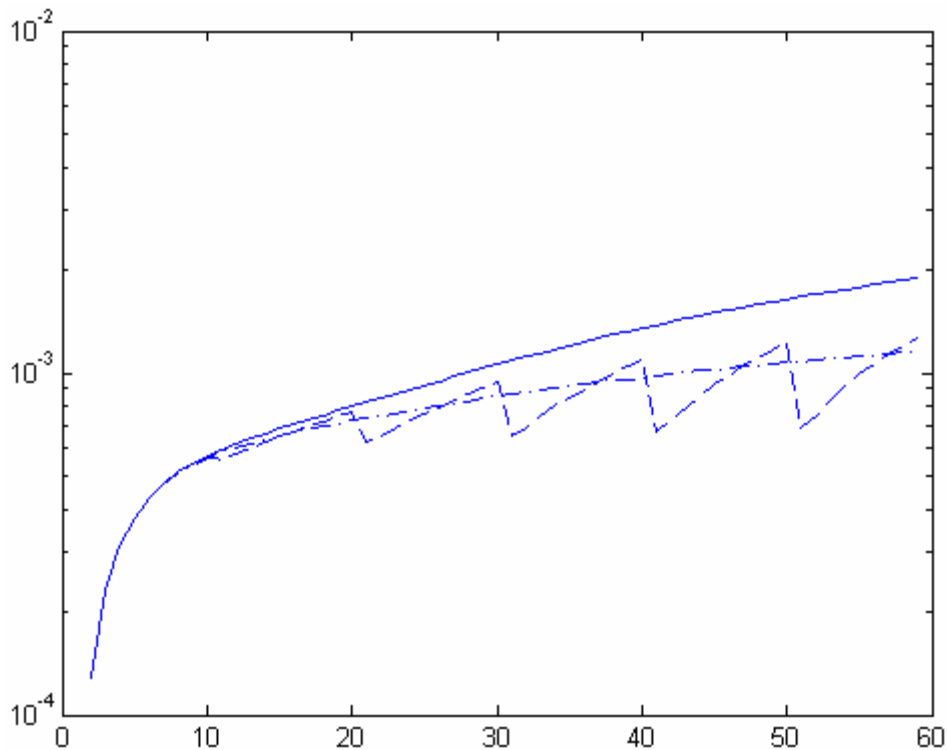

Figure 39. Yearly probability of rupture in at least one weld for no inspections (solid line), fixed inspection strategy (dashed line) and random inspections strategy (dash-dotted).

Markov analyses were carried out using the degradation matrices constructed from the PFM simulations performed with VTTBESIT. For each analysed weld the probabilities of the crack state are calculated with the Markov equation (3). The Markov calculations

are similar for all welds – all the differences are taken into account in the PFM stage of this methodology. Probabilities were calculated for the whole of the planned 60 year lifetime of the NPP units in question.

Three inspection strategies were examined in the risk analyses: no inspections, fixed inspection strategy and random inspections strategy. As an example of the analysis results, Figure 39 presents a graph of the yearly rupture probability of at least one weld for the three selected inspection strategies and for the considered 60 years time span.

The analysis results show that for both random and fixed inspection strategies the risk is approximately five times lower than that for no inspections strategy. The resulting CCDP values varied between $10E-07$ and $10E-09$. For random and fixed inspection strategies most of the analysed welds fell in degradation category into classes Low and Medium, and in consequence category to class Low. The overall risk was in most cases dominated by thermal fatigue cases, mainly due to rapid growth of cracks in the simulations, which in turn was caused by large number of significant thermal load cycles. By increasing the inspection frequency it was possible to lower the risk levels of the examined welds in the analyses.

Conclusions

Characteristics and development of RI-ISI methodology are examined in this report. In particular the aim of this study is to develop a more accurate semi-quantitative modification of the qualitative EPRI RI-ISI risk matrix procedure. This was carried out by applying the combination of PFM and Markov system analyses, and by refining the risk analysis procedure itself.

The applicability of the developed semi-quantitative risk matrix approach was examined as a pilot study performed to the Shut-down cooling system 321 of TVO.

The analysed degradation mechanisms were SCC and thermal fatigue induced cracking in the mixing points. Due to quasi-static loading conditions and other characteristics, SCC analyses were not difficult to perform. However, difficulties were encountered in analysing thermal fatigue induced cracking, due to many involved physical phenomena, e.g. turbulent mixing of fluids of differing temperatures. Here a new and rather straightforward approach was developed to model this degradation mechanism. However, it needs to be developed further due to several involved uncertainties.

As for the degradation state analysis results, they varied for the 16 analysed welds quite a lot. But this was an expected outcome, as the pipe dimensions, loads and overall conditions of the covered locations varied quite a lot as well. Even though all the

inspection targets, usually pipe welds, within a segment should have approximately the same failure potential, according to analysis results here this is not nearly at all the case.

This study further demonstrated the usefulness of Markov analysis procedure developed by VTT in RI-ISI applications. The most important results are the quantified comparisons of different inspections strategies. It was shown in this study that Markov models are useful for this purpose, when combined with PFM analyses. While the numerical results could benefit from further analysis in for example modelling the inspection activities, this does not affect the feasibility of the method itself. Another important result was demonstrating that the RI-ISI risk matrix can be used for planning efficient inspection strategies. By directing more inspection effort into welds in high risk classes, better yearly rupture and core damage probabilities were achieved. Besides forming the risk matrix concerning the piping system 321, with the application it was also possible to optimise it.

While the Markov analysis was successfully demonstrated in this study, a few problem areas remain. As noted earlier, the modelling of inspection activities was accomplished using uniform detection probabilities for cracks and leaks. Possible improvements should include taking into account the quality of the inspection crews, different detection probabilities as a function of the crack size, and incorporating inspection history into the detection probabilities and even inspection strategies.

The most valuable results of this study concerning the semi-quantitative RI-ISI analyses can be considered to be the developed new analysis tools and procedures. It is assumed that they aid in creating a better basis for implementing RI-ISI in Finland.

References

1. Gosselin, S. EPRI's new in-service pipe inspection program. Nuclear News, November 1997, pp. 42–46. ISSN 0029-5574.
2. Modarres, M. What Every Engineer Should Know about Reliability and Risk Analysis. Marcel Dekker Inc. New York, 1993. 351 p.
3. Cronvall, O., Holmberg, J., Männistö, I. & Pulkkinen, U. Continuation of the RI-ISI pilot study of the Shut-down cooling system of the Olkiluoto 1/2 NPP units. VTT Industrial Systems, Espoo. Research Report TUO72-056667. 2006. 60 p.
4. Besuner, P. M. Probabilistic fracture mechanics. In: Provan, J. W. (ed.). Probabilistic Fracture Mechanics and Reliability. 1987, Martinus Hijhoff Publishers. Pp. 325–350.

5. Brickstad, B. The Use of Risk Based Methods for Establishing ISI-Priorities for Piping Components at Oskarshamn 1 Nuclear Power Station. SAQ/FoU-Report 99/05, SAQ Kontroll AB, 1999. 83 p.
6. Raiko, H. et al. Paineistetun termoshokin analysointiohjelma DIFF. Valtion teknillinen tutkimuskeskus (VTT), Valmistustekniikka, työraportti LUJA-1/94. 16.11.1994. 27 p. (In Finnish).
7. Vepsä, A. Verification of the stress intensity factors calculated with the VTTBESIT software. VTT Industrial Systems, Espoo. Research Report TUO72-044578. 2004. 40 p. + app. 2 p.
8. McCormick, N. J. Reliability and Risk Analysis. Academic Press 1981. ISBN 0-12-482360-2. P. 120.
9. Höyland, A. & Rausand, A. Systems Reliability Theory: Models, Statistical Methods, and Applications. Second Edition, Wiley, 2004.
10. Tupala, M. Ydinvoimalaitoksen riskitietoinen putkitarkastuksen optimointi. Master's thesis. Tampere University of Technology, 2002. 54 p. (In Finnish).

4.3 Completion of the new surveillance programme for Loviisa 1

Tom Serén
VTT

Abstract

This paper was presented at the workshop “RADE 2006”, Bansko, Bulgaria, 1–8 April 2006. The main points of interest are: a very comprehensive irradiation-annealing programme with up to three irradiations and two annealings for some chains, application of the kernel-based PREVIEW program with adjustment library, the application of dosimetry plates of a specially made Fe/Ni alloy to account for varying orientation of the chain capsules and the first application of an updated version of PREVIEW and the new IRDF-2002 cross section library.

Introduction

The two VVER-440 units in Loviisa, south-eastern Finland, went into operation in 1977 and 1980, respectively. After the first surveillance specimens from Loviisa 1 had been tested it was realised that the embrittlement of the reactor pressure vessel (RPV) steel had progressed much faster than expected. This led to some immediate and, to some extent, radical actions. After the third cycle in unit 1 and the first cycle in unit 2 the core loading was changed by placing dummy steel assemblies in the peripheral positions (see Figure 40). In order to improve the fluence estimates for the RPV itself, scraping samples for dosimetry purposes were taken from the RPV inner surface (cladding) in unit 1 as early as 1980, after three years of operation with full core. The original surveillance programme was also supplemented by a number of additional material irradiation chains in both units, comprising several types of steel specimens and extended sets of activation dosimeters. Three ex-vessel (cavity) irradiations have also been carried out (unit 1: 1984–1985, 1998–1999; unit 2: 2002–2003) and further scraping samples were taken from the RPV in both units in 1986.

During the maintenance outage in 1996 the RPV of unit 1 in Loviisa was annealed by heat treatment in order to alleviate the embrittlement. This operation, which has been performed on many VVER-440 reactors, was carried out by Škoda JS, Czech Republic.

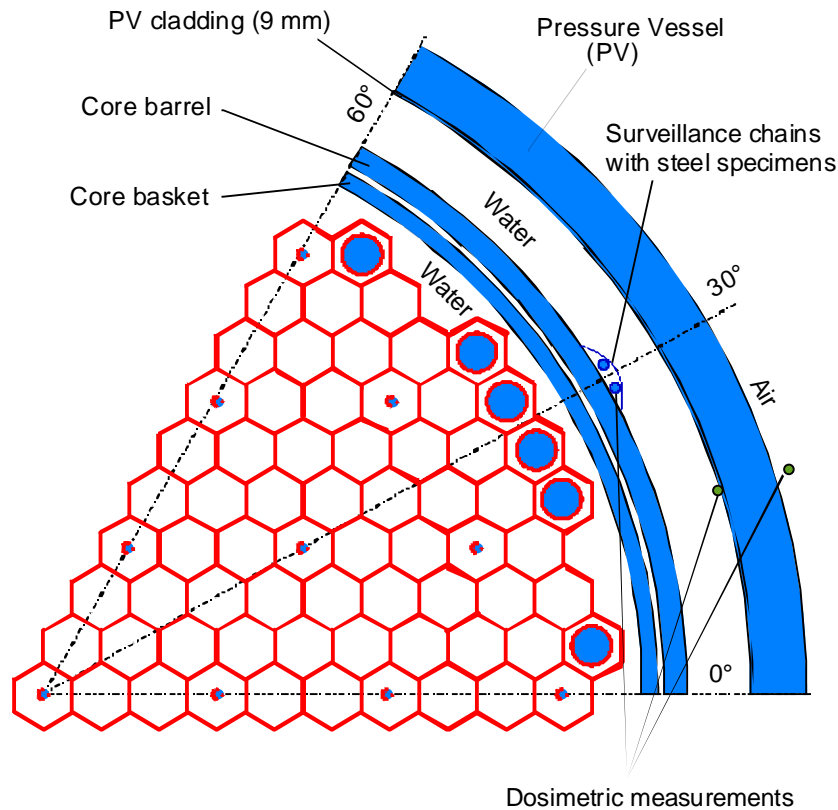

Figure 40. 60-degree symmetry sector of the core and surrounding structures in the Loviisa VVER-440 reactors.

The new surveillance programme for Loviisa 1

A large surveillance programme aimed at investigating the re-embrittlement behaviour of weld material after annealing was initiated the same year. This programme comprised 12 surveillance chains, which were subjected to several different irradiation-annealing sequences (up to three irradiations and two annealings). All six irradiation channels were used. The last of these chains was removed in 2005 and the results of the programme are being compiled and evaluated. The irradiation-annealing sequences for the chains are summarised in Table 6.

The steel specimens (Charpy-V, pre-fatigued COD and half-length CV) were packed three in each container capsule. This required the removal of some material from two edges of the specimens in order to pack them into the standard capsules.

The annealings were performed on-site in Loviisa in a specially acquired heating oven without opening the capsules. The annealing temperature was 475°C during about 100 h and the heating and cooling rates were 20°C/h.

All chains were equipped with activation dosimeters, and chain S1 (not annealed) also with sets of melting alloys to monitor the irradiation temperature.

Table 6. Summary of material irradiation chains in the new surveillance programme for Loviisa 1.

Irradiation channel	Chain	Removed	Irrad./anneal. history	Container capsules	Steel specimens		
					Charpy-V	COD	1/2 CV
I	S1	1999	I ₃	8	12	12	
I	S2	2005	I ₃ A ₃ A ₃	4	12		
II	S3	1999	I ₃ A	7	11		2
II	S4	1999	I ₃ A	7		11	2
III	S5	2000	I ₃ A ₁	8	12	12	
III	S6	2001	I ₃ A ₂	4	12		
IV	S7	2002	I ₃ A ₃	8	12	12	
IV	S8	2003	I ₃ A ₄	4	12		
V	S9	2002	I ₃ A ₃ A	7	20		2
V	S10	2002	I ₃ A ₃ A	7		20	2
VI	S11	2003	I ₃ A ₃ A ₁	8	12	12	
VI	S12	2004	I ₃ A ₃ A ₂	8	12	12	

I = irradiation, A = annealing, subindex = number of cycles.

Neutron dosimetry arrangements

Due to the suspension system (capsules joined with chain links) the orientation of the container capsules is effectively random. The orientation of the capsules will therefore most likely be different from the original orientation when re-inserting them after the annealing. The radial fast-flux gradient is about 15%/cm at the surveillance position.

This means that conventional dosimetry based mainly on the $^{54}\text{Fe}(n,p)^{54}\text{Mn}$ reaction cannot be applied because the reaction product will to some extent “remember” the pre-annealing irradiation ($T_{1/2} = 312$ d). Thus dosimeter plates made from a special 70%Fe/30%Ni alloy have been used for accurate post-annealing fluence determinations, while still maintaining the direct comparability with previous results based on Fe plates. The plates (0.25 mm thick) in the form of cut circles were placed above and below the specimens in direct contact.

With this arrangement several dosimetry reactions are available: $^{54}\text{Fe}(n,p)^{54}\text{Mn}$, $^{58}\text{Ni}(n,p)^{58}\text{Co}$ ($T_{1/2} = 71$ d), $^{58}\text{Ni}(n,X)^{57}\text{Co}$ ($T_{1/2} = 272$ d) and $^{58}\text{Fe}(n,\gamma)^{59}\text{Fe}$ ($T_{1/2} = 44.5$ d). Of these reactions the first two are the most useful. The third reaction would in principle

be useful, but reliable cross section data are lacking. The last reaction is caused by thermal and epithermal neutrons.

Using a specially designed pneumatic device Ø8 mm samples were punched from the Fe/Ni plates at the lateral positions of the specimens for activity measurements. Usually only one of the plates was used to minimise personnel dose (the axial gradients were not significant).

In addition to the Fe/Ni plates a few capsules in chains S1, S2, S3 and S4 were equipped with dosimeter sets for spectrum checking and adjustment (Fe, Ni, Nb, Ti, Cu, Co-Al) in the form of foils and wires inserted into holes in the side fillings. Two Cd-capsules with Fe, Ni, Ti, Nb, ^{238}U and ^{237}Np were irradiated in chain S1. Several Nb wire samples were further irradiated in small holes in the side fillings to determine the total fluence over the whole irradiations ($^{93\text{m}}\text{Nb}$, $T_{1/2} = 16 \text{ y}$).

Analysis method: the PREVIEW program

The kernel-based PREVIEW (PREssure Vessel Irradiation Evaluation Working Program) program [1] developed by F. Wasastjerna is routinely used at VTT for accurate determination of neutron fluences from measured activities.

PREVIEW considers a 60-degree VVER-440 symmetry sector (see Figure 40) with either full or reduced core loading configuration. It calculates the neutron flux or fluence and various reaction rates, reaction probabilities and activities at a limited number of chosen out-of-core locations (called detector points). This is accomplished by multiplying the nodewise source distribution in the reactor core by pre-calculated transport kernels. Each fuel bundle in the core sector is divided into 10 nodes of 25 cm length (22 cm for the outermost nodes). The pre-calculated kernels represent the contribution of a unit source of fission neutrons (^{235}U and ^{239}Pu) at the detector locations. The possible radial locations are: 162.5 cm (surveillance chain), 177.3 cm (RPV cladding), 181.5 cm (RPV $\frac{1}{4}$ thickness) and 207.5 cm (middle of cavity outside RPV).

The power history is given in weekly intervals and the burnup and source distribution in monthly intervals. Thus the changes in the axial flux distribution over an operating cycle are taken into account with good accuracy, which is important in the interpretation of more short-lived reaction products (such as ^{58}Co).

An adjustment library [2] based on a large number of activity measurements and spectrum adjustments with the LSL-M2 code [3] has been developed. By applying this library very good agreement is usually achieved between calculated and measured activities.

The final fluences and dpa for the specimens are obtained by scaling the calculated values by the ratio between measured and calculated ^{58}Co activities, adjusted to the average scaling factor for ^{58}Co and ^{54}Mn (usually a very small difference).

Results

Generally we have achieved very good agreement between calculated (PREVIEW) and measured activities. An example is shown in Figure 41.

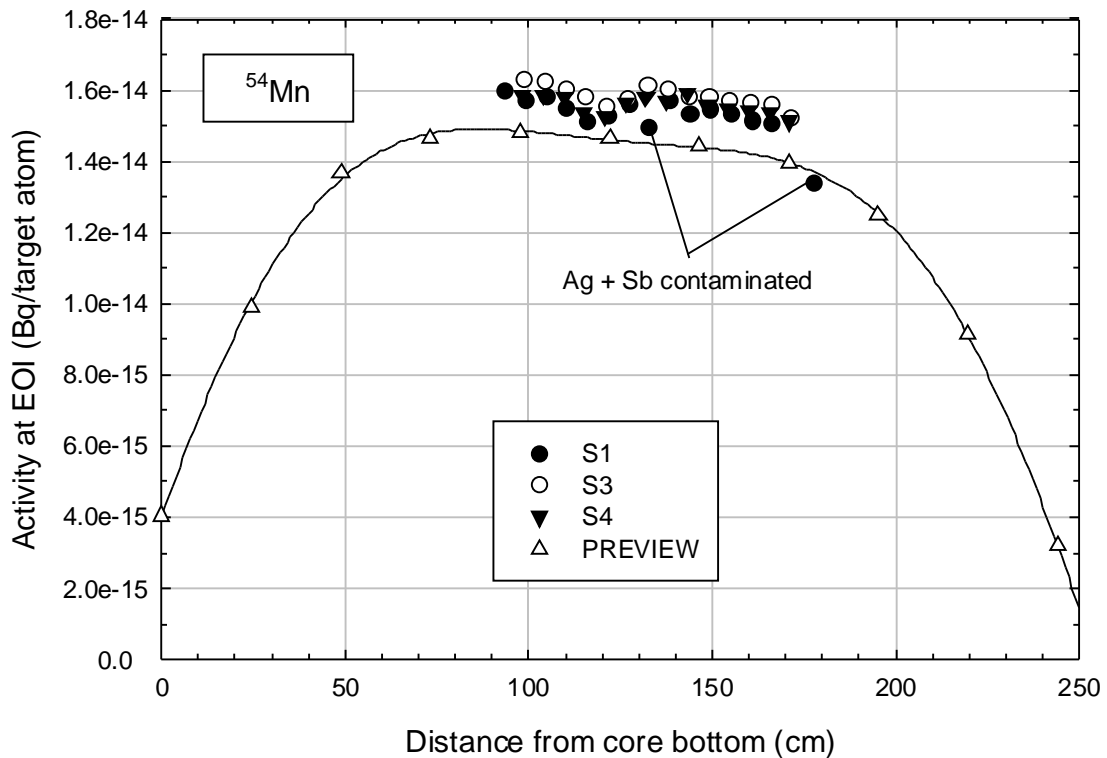

Figure 41. Comparison between measured and calculated (PREVIEW) ^{54}Mn activities in Fe/Ni plates from chains S1, S3 and S4 (three cycles irradiation).

For ^{58}Co the corresponding comparison looks very similar. A slight underestimation can be observed.

For most chains the agreement has, in fact, been better than in the example chains. In summary, we have obtained the following least-squares scaling factors (SF):

<u>Chain</u>	<u>SF(⁵⁴Mn)</u>	<u>SF(⁵⁸Co)</u>
S1, S3, S4:	1.079	1.070
S5:	1.020	1.043
S6:	1.035	1.046
S7:	1.059	1.026
S8:	1.072	1.053
S9:	1.052	1.024
S10:	1.057	1.030
S11:	1.068	1.043
S12:	1.048	1.053

From the dosimeter sets in chains S1, S3 and S4 the following average C/E ratios compared to ⁵⁴Mn were obtained:

⁵⁸Co (Ni): 1.032, ⁶⁰Co (Cu): 1.068, ⁴⁶Sc (Ti): 0.973, ⁹⁵Zr (Np): 0.930, ¹³⁷Cs (Np): 0.875, ⁹⁵Zr (U): 0.868, ¹³⁷Cs (U): 0.842, ^{93m}Nb: 0.994.

The somewhat high value for ⁶⁰Co seems to indicate a slightly too “hard” calculated spectrum, although the discrepancy is not serious. The value for ⁴⁶Sc may be influenced by a small Sc impurity in Ti. The fissionable detectors are somewhat problematic because of gamma-induced fission, which is difficult to quantify. ²³⁷Np is indeed in better agreement than ²³⁸U, which is more sensitive to photofission. For Nb the agreement is excellent.

Conclusions

The last chain (S2) has recently been analysed and reported, but is not included in this paper. We are now in a position to carry out a summary and re-evaluation using the updated version of PREVIEW with new location-specific dosimetry and damage cross sections based on the new IRDF-2002 library [4]. Some of the Nb wires from chain S2 will also be analysed to evaluate the total fluence received by the long-term chains. An evaluation of the pre-annealing fluence for all specimens will also be carried out.

References

1. Wasastjerna, F. PREVIEW – A Fast Kernel-Based Program for Calculation of Pressure Vessel Irradiation. Proceedings of the Topical Meeting on New Horizons in Radiation Protection and Shielding. Pasco, Washington, April 26 – May 1, 1992.

2. Serén, T. An Optimised Adjustment Library for the Kernel-Based PREVIEW Program. Licentiate's Thesis, Helsinki University of Technology, Department of Engineering Physics and Mathematics, November 2001.
3. Stallmann, F. W. LSL-M2: A Computer Program for Least-Squares Logarithmic Adjustment of Neutron Spectra. NUREG/CR-4349, ORNL/TM-9933, Oak Ridge 1986.
4. International Reactor Dosimetry File – 2002 (IRDF-2002). IAEA Nuclear Data Section, Vienna 2005. <http://www-nds.iaea.org/irdf2002/>.

4.4 Applicability of small specimen test results

Tapio Planman
VTT

Abstract

The standardisation work carried out in the ASTM and ESIS committees consists of both the small specimen testing and the data analyses procedures based on the Master Curve technique. This collaboration together with own research and development work have ensured effective transfer of know how on small specimen test techniques and their development into standardised procedures. The standardisation work has been successfully supplemented by the IAEA Co-ordinated Research Projects and the AMES Thematic Network on Ageing (ATHENA) where guidelines and recommendations have been prepared on application and limits of the Master Curve approach in reactor pressure vessel integrity assessments. The most ambitious objective is to simulate numerically the microstructural phenomena occurring in reactor pressure vessel and reactor internal materials due to neutron irradiation and how such defects affect materials mechanical and corrosion properties. The derived correlation between materials yield strength and the fracture toughness reference temperature (T_0) is one result achieved in the PERFECT project where these fracture models are developed.

Introduction

The Master Curve technique has been developed at VTT since 1980. Small specimen test procedures of determining the fracture toughness of ferritic steels have increasingly been introduced in reactor pressure vessel applications since the issue of the first standard (ASTM E 1921-97) on this technique. In the SAFIR programme, this standardisation work has been continued and, on the other hand, new applications for analysing more complicated situations like inhomogeneous materials and welded structures have been published. Refined cleavage fracture models development, materials microstructural characterisation (TEM, SEM) and theoretical and empirical fracture modelling are topic areas studied in the PERFECT project.

Main objectives

The objectives were to

- actively contribute to the standardisation and codification work covering the small specimen test techniques and the Master Curve procedure for determining the

fracture toughness of ferritic steels, including reactor pressure vessel materials, and to bring VTT's experience and know how into this work (ASTM, ESIS, AMES),

- quantify more precisely the limits of applying the Master Curve technique in RPV applications (e.g. IAEA co-ordinated projects),
- develop theoretical and empirical fracture models for simulating the ageing phenomena of reactor pressure vessel and reactor internal materials (Euratom project "PERFECT").

Main results

As a result of the work of the ASTM standardisation committee, a new ASTM standard revision (ASTM E 1921-05) was issued. In this standard, some improvements concerning the testing and determination of fracture toughness have been made compared to the E 1921-02 edition. The IAEA Technical Report on application of the Master Curve approach to reactor pressure vessel integrity assessments was issued in 2005. [1–4]

Different pre-cracking criteria were examined based on the warm pre-stress (WPS) effect. In the case of cleavage fracture, the WPS criteria used for a so-called load–unload–(cool)–fracture transient showed to be well suited also to describe the effect of pre-fatigue on the measured fracture toughness. Testing at a different temperature than the pre-fatigue temperature does not require any correction related to yield strength change. A slight modification of a simple analytical WPS expression provides a conservative description of the pre-fatigue effect. The derived adjustment is conservative both for brittle and ductile fracture. [5]

Different crack growth corrections were examined and compared both with each other as well as with other analytical and numerical estimates, applicable both in incremental as well as integral form. As a result of this study a new correction, which is capable of unifying the different testing standards, was proposed. [6]

A general Master Curve approach consisting of the different procedures, their selecting criteria and the statistical engineering methods proposed for assessing the quality of measured fracture toughness data was presented as part of the AMES Thematic Network on Ageing (ATHENA) project. [7–9]

In this study, attention was paid to the recognised "open issues" like the bias of T_0 between different type specimens and the temperature dependence or the shape of the K_{Ic} vs. temperature curve. Abnormal fracture toughness vs. temperature behaviour may result if the material doesn't follow the assumed cleavage fracture model. The objective was to outline a

concept for a “general” Master Curve approach for RPV and corresponding materials as well as for statistical methods for qualifying and analysing different fracture toughness data.

An analysing procedure suitable for a variety of different material conditions was obtained when the standard procedure (ASTM E 1921) was complemented with extensions for analysing abnormal fracture toughness data. This approach has already been included in some design guides as tools for analysing certain types of structural integrity applications, such as welded and/or thick-walled heavy structures.

Based on new experimental data collected in the PERFECT project, a simple equation for the relation between the change in yield strength and the shift in fracture toughness transition temperature was proposed (Figure 42).

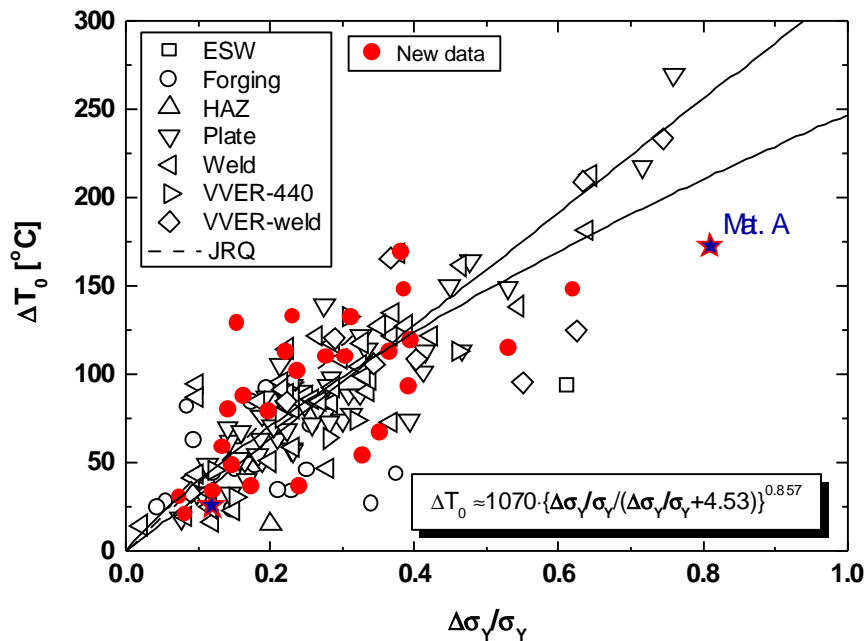

Figure 42. Preliminary proposal for relation between the change in yield strength and the shift in fracture toughness transition temperature [10].

The work performed in PERFECT has formed the basis for a more detailed and comprehensive study on the correlation between the irradiation induced change in yield strength and the shift in fracture toughness transition temperature. It also provides input to the micromechanistic modelling of pressure vessel embrittlement by providing a simple equation to be used to predict the embrittlement. [10–11]

Applications

The small specimen test and Master Curve techniques are increasingly applied in the surveillance programmes and integrity assessments of reactor pressure vessels. Besides

the standard procedure, modifications specifically developed for certain abnormal material and loading conditions have been introduced. Their applicability and limits have been demonstrated in several round-robin type research programmes.

Conclusions

1. The successful standardisation and guides and methods development work on materials fracture mechanical testing makes possible increased use and applications of the small specimen test techniques and the statistical analysing tools based on the Master Curve approach.
2. Applying the derived pre-fatigue adjustment, it is possible to define new, more efficient pre-cracking rules for different fracture toughness testing standards, especially for ASTM E 1921.
3. The correlations developed between the reference temperature T_0 and materials mechanical properties forms the basis for a more detailed and comprehensive study of the correlation between the irradiation induced change in yield strength and the shift in fracture toughness transition temperature. It also provides input to the micromechanistic modelling of pressure vessel embrittlement.
4. The first study to clarify the effect of alloy and impurity elements indicates no distinct element or a combination of elements (chemistry factor) which could explain the scatter in the fracture toughness vs. yield strength change.

References

1. Brumovský, M., Faidy, C., Karzov, G., Ki-Sig Kang, Kryukov, A., Lapena, J., Lott, R., Lyssakov, V. N., Nanstad, R., Planman, T., Rosinski, S., Serrano, M., Server, W. L., Sevini, F. & Viehrig, H.-W. Guidelines for application of the Master Curve approach to reactor pressure vessel integrity in nuclear power plants. Vienna: IAEA, 2005. Technical Reports Series No. 429. 105 p. ISBN 92-0-112104-0.
2. Brumovský, M., Planman, T., Viehrig, H.-W., Gillemot, F., Horvath, M., Server, W., Nanstad, R. & Rosinski, S. Application of surveillance programme results to reactor pressure vessel integrity assessment. Results of a coordinated research project 2000–2004. Vienna: IAEA, 2005. IAEA-TECDOC-1435. 57 p. ISBN 92-0-101605-0.

3. Wallin, K. The misconception(s) of ASTM E399, plane-strain fracture toughness K_{IC} . Baltica VI, International Conference on Life Management and Maintenance for Power Plants. Helsinki – Stockholm – Helsinki, 8–10 June, 2004.
4. Wallin, K. Critical assessment of the standard ASTM E399. (To be published in *Fatigue and Fracture Mechanics*, Vol. 34).
5. Wallin, K. Warm pre-stress based pre-cracking criterion for fracture toughness testing. *Engineering Fracture Mechanics*, 2004, Vol. 71, pp. 1737–1750.
6. Wallin, K. & Laukkanen, A. Improved crack growth corrections for J-R-curve testing. *Engineering Fracture Mechanics*, 2004, Vol. 71, pp. 1601–1614.
7. Wallin, K., Nevasmaa, P., Laukkanen, A. & Planman, T. Master Curve analysis of inhomogeneous ferritic steels. *Engineering Fracture Mechanics*, 2004, Vol. 71, No. 16–17, pp. 2329–2346.
8. Wallin, K. & Planman, T. Master Curve implementation for component assessment. AMES Thematic Network on Ageing (ATHENA), Work Package 3, Final Report. Espoo: VTT Industrial Systems, 2004. Research Report TUO72-044798. 21 p. + app. 4 p.
9. Wallin, K. Inhomogeneity check of the ‘Euro’ fracture toughness reference data set. The 15th European Conference of Fracture Advanced Fracture Mechanics for Life and Safety Assessments. Stockholm, Sweden, 11–13 August 2004.
10. Wallin, K., Laukkanen, A. & Planman, T. Proposed expression for the irradiation induced change in yield strength and the shift in the fracture toughness transition temperature (T_0) for different conditions of irradiation and material chemistry. Brussels: European Commission, 2006. PERFECT (Contract No. F160-CT-2003-508840). Deliverable (D-N^o: M3.1). 20 p. (Confidential).
11. Laukkanen, A. Boundary element method founded inference of local approach parameters. Espoo: VTT Industrial Systems, 2004. Research Report BTUO72-041260.

5. LWR oxide model for improved understanding of activity build-up and corrosion phenomena (LWROXI)

5.1 Further development of the Mixed-Conduction Model of oxide films in LWRs emphasising surface complexation and reprecipitation

Petri Kinnunen, VTT

Martin Bojinov, University of Chemical Technology and Metallurgy, Sofia, Bulgaria

Jarmo Lehtikoinen, VTT

Klas Lundgren, ALARA Engineering, Sweden

Abstract

The ultimate goal of this work is to develop a deterministic model for activity build-up and to increase the theoretical understanding of the oxide film build-up and breakdown, controlling the localised corrosion of structural materials in Light Water Reactors. The first step of the overall reaction of activity build-up in oxidised structural material surfaces in primary LWR circuits is the interaction of activated ionic species from the coolant with the oxide layers, involving surface complexation and redeposition stages. An experimental investigation of the interaction of the LWR oxides with coolant-originating species was performed to assess the thermodynamics of these stages. A series of high-temperature titrations at 280°C was performed, in which the competitive adsorptivity of Zn, Co and Ni cations onto iron oxide surfaces has been studied. The experiments provided the necessary information concerning the reactions at outer oxide / coolant interface. The obtained results were quantitatively interpreted using the diffuse layer and non-electrical surface complexation models and the extracted stability constants of the surface complexes were found to be in agreement with extrapolations of room-temperature data. The determination of the kinetic and transport parameters for the subsequent incorporation of Zn in the inner oxide layer on stainless steels and nickel alloys is based on the fitting of experimental depth profiles of these elements to the diffusion-migration equations for the non-steady state transport. The obtained parameter values are discussed in terms of the dynamics of the oxides on the structural materials.

Introduction

The crucial role of the oxide films formed on metallic construction materials during their exposure to Light Water Reactor (LWR) coolants in controlling the general corrosion of these materials, acting as a barrier against localised corrosion modes and at the same time as a reservoir for radioactivity build-up in the reactor primary circuit, has been recognized for quite some time. The investigations of the mechanism(s) of the influence of the oxide layers on all these processes have been directed basically in two ways. The first, related mainly to the study of the role of the surface oxides in different forms of material corrosion, has resulted in the elaboration of several models for film growth and restructuring, as well as corrosion product release [1–8]. These models are based mainly on surface analytical and morphological data stemming from ex-situ characterisations of the oxides formed during exposure to a range of (electro)chemical conditions (both real and simulated) which were pertinent to the different types of operating nuclear power plants. The second type of studies related to the role of oxides has been mainly promoted by the need to understand the mechanism of radioactivity build-up in primary circuits, as well as that of stress corrosion crack initiation, and has mainly focused on the interaction of the oxides with coolant-originating cationic and anionic species [1–17]. In these approaches, the growth and restructuring of the oxides in simulated or real LWR conditions have been studied mostly by ex-situ in-depth analysis of the profiles of electrolyte-originating cationic species (Zn, Mn, Mg, Ni, etc.) throughout the surface film on the construction material.

In the LWROXI project a conceptual four-layer model for the oxide layers formed on construction materials in LWRs has been presented by cross-linking the two approaches. The model is based on the data obtained from experiments on the adsorption/surface complexation of the coolant-originating species onto the hematite surface combined with electrochemical and ex-situ investigations on the oxide film composition and the first stages of film formation both in simulated and real power plant conditions.

Experimental

The experimental part of this work consisted of two different types of tests in simulated BWR conditions. First of all, the adsorption and surface complexation of coolant – originating species onto the hematite surface were studied at 280°C using a novel high-temperature titration procedure developed in the FINNUS and SAFIR programmes between 1998–2004. The detailed description of the equipment is given in ref. 17 and of experiments in ref. 19. Briefly, the test assembly consisted of a suspension containing hematite in purified water in the autoclave, de-aerated with N₂/H₂ gas and heated up to 280°C. After reaching a stable temperature the suspension was acidified with HNO₃,

after which zinc, nickel or cobalt nitrate solution was added to the autoclave. The titration was done with NaOH as the titrant. The suspension was stirred using a gas flow during pumping. The pH was measured with a $\text{Cu}_2\text{O}/\text{Cu}$ high temperature pH electrode and the AgCl/Ag reference electrode.

Secondly, the kinetic and transport parameters of the growth and restructuring of the oxide on stainless steels have been experimentally produced in this project using electrochemical impedance spectroscopy at relevant temperatures or collected from literature. The results and experimental procedures for the oxidation studies on AISI 316 L have been presented in ref. 20.

Results

Thermodynamic parameters of surface complexation

Adsorption/surface complexation experiments aiming at two different theoretical coverages of the hematite surface with Co, Ni and Zn (60 and 100%) were performed. An example of the results obtained is shown in Figure 43.

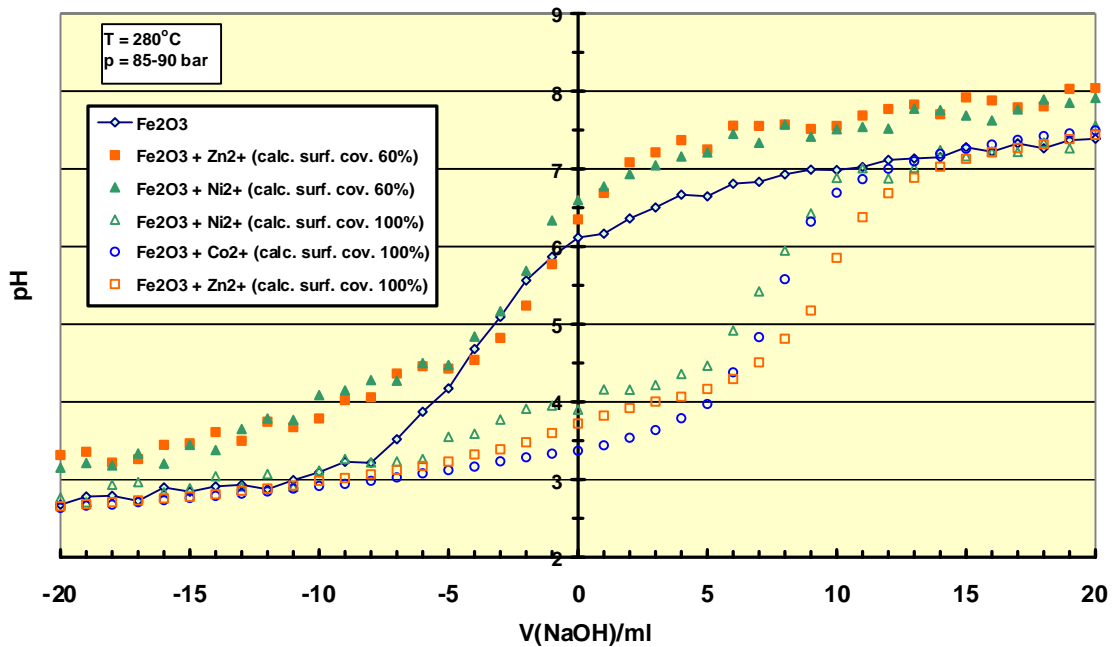

Figure 43. Titration curves of hematite suspension into which different cations (Zn^{2+} , Ni^{2+} , Co^{2+}) have been added so that the theoretical surface coverage (either 60 or 100%) has been obtained.

In overall, the differences between the curves obtained with different cation additions are rather small. Especially in experiments with the theoretical surface coverage of 60%,

the differences between pure hematite suspension and the suspensions containing different cations were negligible. This most probably indicates that the theoretical surface coverage of 60% was not reached, but instead the amount adsorbed onto the hematite surface was very low. With the higher cation concentrations (i.e. theoretical surface coverage of 100%) the titration curves have clearly moved to higher NaOH concentrations indicating that adsorption to the surface has occurred, which has led to the release of protons from the hematite surface. Moreover, some differences in the adsorption of different cations can be observed. In the experiments aiming at a theoretical surface coverage of 60%, the neutralisation of a plain hematite suspension takes place with lower amounts of NaOH than can be assumed based on the amount of used acid. This observation indicates that a certain amount of protons stays adsorbed to the hematite surface and is supported by the fact that the cation addition does not remarkably change the situation. Conversely, in experiments aiming at a theoretical surface coverage of 100%, the neutralisation takes place at NaOH volumes considerably higher than expected based on the amount of used acid. One possible explanation to this feature may be that protons from the hydrolysed hematite surface in water solution also contribute to the total concentration of neutralised protons.

The theoretical treatment of the data consisted of their fitting to several different surface reaction models: diffuse layer model (DLM), the constant capacitance model (CCM) and the non-electrostatic model (NEM), for which all electrostatic effects are omitted. The surface hydrolysis of hematite was described in terms of the 1-pK surface complexation model (a single step reversible reaction) in which only one surface protonation step is required,



in contrast to the more common 2-pK approach for which a protonation and a deprotonation step are required (cf. e.g. ref. 21). For the 1-pK model, a surface functional group is denoted by $\equiv\text{SOH}_{1/2}^{\circ}$.

Combinations of surface complexation reactions of the general form,

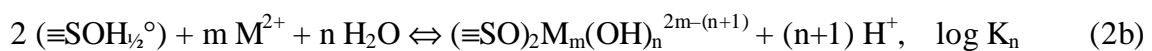

where $m = 1$ or 2 and $n = 0, 1, 2, \dots$, were tried to fit the experimental titration data for systems with a metal cation, M (Zn, Ni, Co), added. Fitting of the experimental data to the surface complexation models revealed that different models needed to be used for different hematite types. As a main result from the modelling, estimates of the stability constants for reactions 2a and 2b were obtained. They are collected in Table 7 and Table

8. The speciation of Zn, Ni and Co in pure water at 280°C was also calculated, as shown in Figure 44.

Table 7. Optimized $\log K_0$ (reaction 2a) and $[\equiv\text{SOH}]_T$ for the NEM.

Fit	$\log K_0$	$[\equiv\text{SOH}]_T (\times 10^6 \text{ mol/g})$
Zn	20.47	5.3
Ni	18.86	5.3

Table 8. Optimized DLM stability constants for reaction (2b).

n	$\log K_n$		
	Zn ^a	Ni ^a	Co ^b
3	5.18	1.61	
5	-0.23	-5.99	5.37

^a Monodentate reaction (m = 1), ^b Bidentate reaction (m = 2)

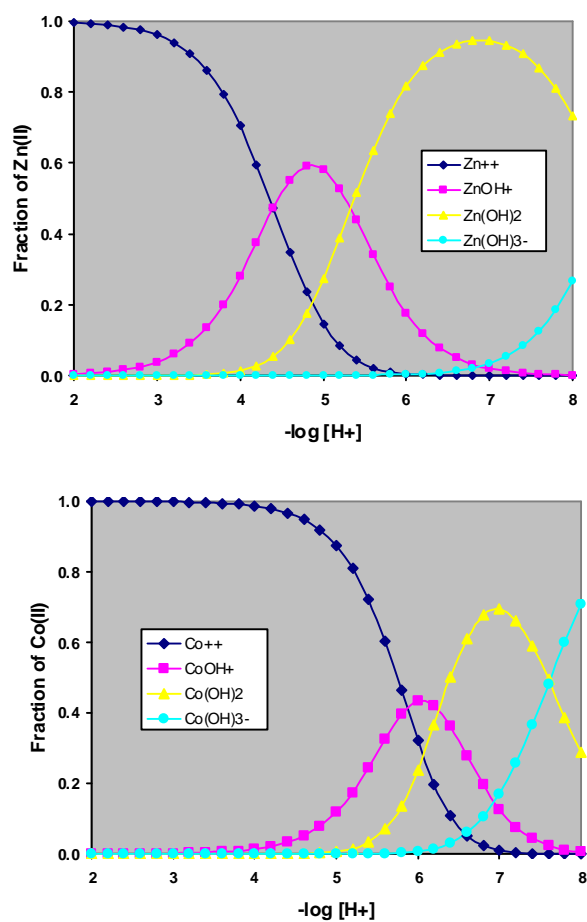
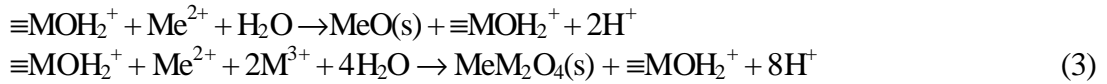

Figure 44. Speciation of Zn(II) (left) and Co(II) (right) in pure water at 280 °C.

Kinetic and transport parameters for the incorporation of minor species

The possible steps of the interaction reaction of a cationic species from the coolant, Me^{2+} , with the oxide layer are schematically presented in Figure 45. The steps include:

1. adsorption and incorporation in the particulate deposited layer (a minor contribution)
2. adsorption and surface complexation at the porous outer layer / coolant interface (reaction 2 above)
3. incorporation in the porous outer layer via surface precipitation as a single- or mixed-valency oxide, e.g.



where $\equiv\text{MOH}_2^+$ represents a protonated surface hydroxyl group at the oxide / water interface, MeO and MeM_2O_4 are hypothetical oxides. These reaction sequences have been plausibly accounted for by a reprecipitation model using a constant capacitance surface complexation approach, as discussed above.

4. place exchange, transport and incorporation in the pore-free parts of the outer layer via filling of available interstices, V_i

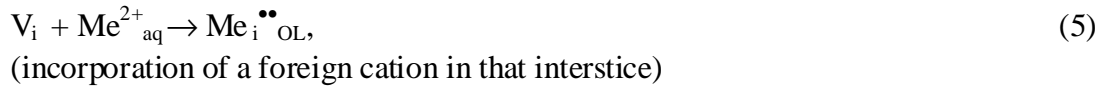
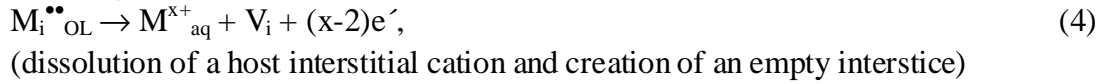

5. transport and incorporation in the inner layer via filling of cation vacancies, V_M''

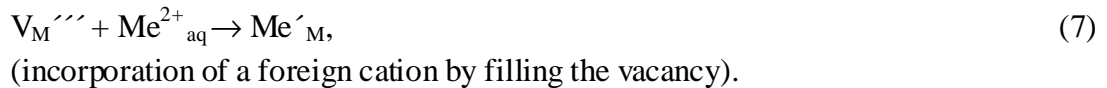
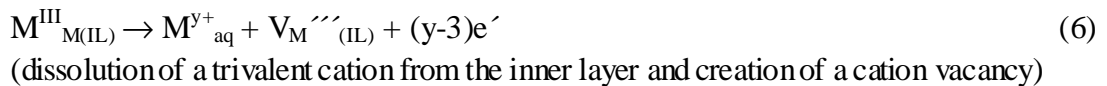

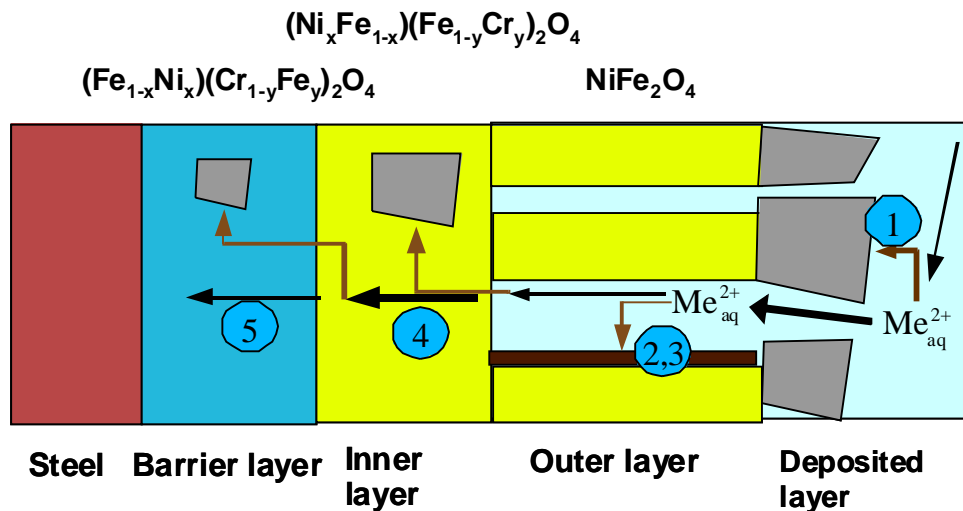

Figure 45. Possible steps of the reaction of interaction of a foreign cation from the coolant water with the oxide layer on stainless steel.

In order to compare this conceptual view with experimental data of the incorporation of cations from the coolant into growing oxide films, the following simplifications are considered:

- incorporation in the barrier layer has been considered negligible
- incorporation in the inner layer via the reaction sequence (6)–(7) is neglected because of the fact that transport via vacancies is considered to be much slower than that via interstitials
- incorporation in the deposited layer is neglected
- as the outer layer is discontinuous, the incorporation of cations from the coolant into it is assumed to follow a simple diffusion mechanism
- the place-exchange mechanism for incorporation in the inner layer, which is chiefly considered below, is assumed to proceed as a diffusion-migration process with a formal diffusion coefficient characterising the inward transport of foreign cations.

In order to predict quantitatively the depth profile of the cation from the coolant that is incorporated into the growing oxide, the diffusion-migration equation for the non-steady state transport of minor species needs to be solved. For the solution of this transport equation the boundary condition from the solution side is obtained from the experimental results obtained in titrations (above) an/or from the estimates presented in literature. The solution of the transport equation shows the concentration of incorporated species as a function of time and position in the oxide film

$$c(x,t) = C_1 e^{\frac{zFE}{RT}x} e^{-\frac{C_4Dt}{RT}} \left\{ C_2 e^{0.5 \frac{\sqrt{(zFE)^2 - 4C_1RT}}{RT}} + C_3 e^{-0.5 \frac{\sqrt{(zFE)^2 - 4C_1RT}}{RT}} \right\} \quad (8)$$

where the constants are to be determined by the initial and boundary conditions. However, this determination requires in principle the use of numerical methods to solve the corresponding set of equations. The implementation of the numerical solution of the transport equation involves the film growth law derived on the basis of the MCM

$$L(t) = L(t=0) + \frac{1}{b} \ln \left[1 + k_2^0 b e^{-bL(t=0)t} \right], \quad (9)$$

$$b = \frac{3\alpha_2 F E}{RT}$$

The correspondences between the experimental thickness vs. time dependences and depth profiles of incorporated Zn are shown in Figure 46. They demonstrate the ability of the model to predict correctly the experimental relationships, especially between the calculated and experimental Zn concentrations.

In overall, the fits (concerning especially the Zn concentration) can be considered satisfactory, keeping in mind the fact that a homogeneous diffusion-migration is used to describe the incorporation which is expected to be dependent on the local composition and chemical environment in the inner layer of the oxide. Also the fact that the elongated tails of the profiles close to the alloy/film interface are not predicted is by itself not surprising, since that fact is in accordance with the assumption of no incorporation in the barrier layer used in the calculations. In addition, the elongation of the profiles could be due to a gradient in the grain size of the inner layer close to the interface which has not been taken into account in the present simplified approach.

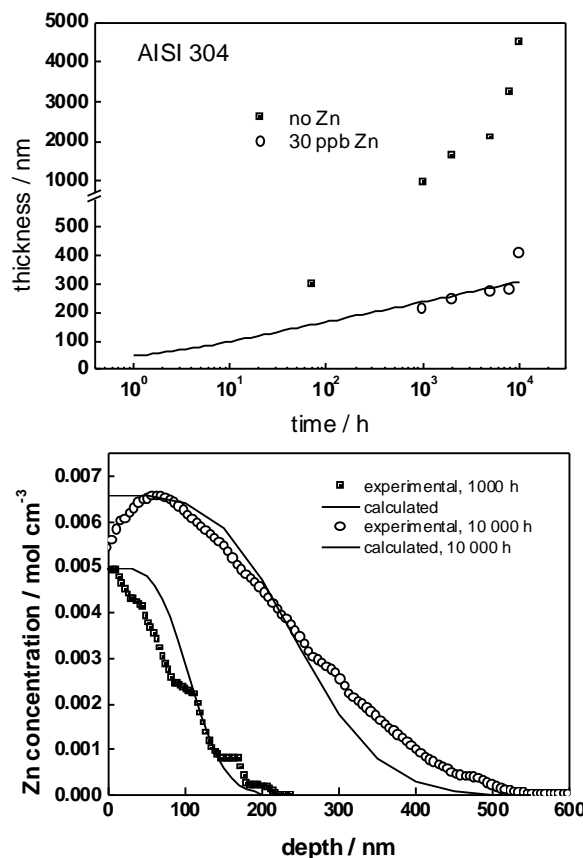

Figure 46. TOP: Thickness of the inner layer vs. time for AISI 304 with or without the addition of 30 ppb Zn to a simulated secondary PWR coolant [22]. The fit to the equation of the MCM also shown. BOTTOM: Experimental (points) and predicted (solid lines) depth profiles of Zn in the inner layer of a growing oxide on AISI304 in secondary PWR coolant for two periods of exposure (1000 and 10 000 h).

Table 9. Kinetic and transport parameters of the incorporation of Zn into the growing oxides estimated by the calculational procedure.

Case	$\log K_{\text{enrich}}$	$D / \text{cm}^2 \text{s}^{-1}$	$\frac{u}{E} / \text{kV cm}^{-1}$
AISI 304, BWR, 1000 h, 10 ppb Zn	7.89	3×10^{-18}	20
AISI 304, BWR, 1000 h, 50 ppb Zn	7.41	1.5×10^{-18}	20
AISI 304, PWR, 1000 h, 30 ppb Zn	7.03	1.5×10^{-17}	15
AISI 304, PWR, 10 000 h, 30 ppb Zn	7.15	1.0×10^{-17}	15
Alloy 600, PWR, 5000 h, 30 ppb Zn	7.43	2.5×10^{-19}	30
Alloy 600, PWR, 10 000 h, 30 ppb Zn	7.58	1.0×10^{-19}	20

Discussion and Conclusions

The estimates for some of the MCM parameters obtained from the modelling are given in Table 9. The values of the log K_{enrich} can be considered as a compromise between the thermodynamic estimates of the stability constant of the Zn complex (Table 7, Table 8) determined on the basis of high-temperature titrations and those extrapolated from room-temperature data [22]. The diffusion coefficient for incorporation of Zn in stainless steels is of the same order of magnitude as that determined for the transport of major cations in the films on nickel alloys via a vacancy mechanism [23]. It is important to note that the diffusion coefficients are the highest in the inner layer of the films formed on AISI 304 in a secondary PWR coolant and by far the lowest in the films on Alloy 600 in the same medium. This fact is in line with the much more pronounced barrier character of the inner layer on Alloy 600. The values for AISI 304 in BWR are situated in between the two extremes, but these have to be considered as somewhat less reliable since the calculational procedure has not been calibrated with the thickness vs. time dependence as was done for the PWR case. The field strengths in the inner layers of the oxides are of the same order of magnitude, albeit smaller than those calculated from the impedance data for much shorter oxidation times [23]. Thus the calculated values for the incorporation constants can be considered as reliable first estimates and can be used in the integrated activity build-up model.

In general, it can be concluded that the present approach combining high-temperature laboratory experiments and an extensive four-layer oxide film modelling has been demonstrated to be a novel tool to investigate the activity incorporation into the oxide films in nuclear power plants. Using this kind of modelling the critical rate limiting steps in the incorporation processes can be distinguished and the treatment of the problem simplified. As a next step in the modelling, it will be assumed that in the inner compact layer, the rate of point defect transport is a function of the area of conductive paths. These paths will be defined in terms of the geometrical and energetical heterogeneity of the transport medium.

References

1. Tomlinson, L. Corrosion 1981, Vol. 37, p. 591.
2. Lister, D. H., McAlpine, E. & Davidson, R. D. Corros. Sci. 1987, Vol. 27, p. 113.
3. Robertson, J. Corros. Sci. 1991, Vol. 32, p. 443.
4. Stellwag, B. Corros. Sci. 1998, Vol. 40, p. 337.

5. Beverskog, B., Bojinov, M., Kinnunen, P., Laitinen, T., Mäkelä, K. & Saario, T. *Corros. Sci.* 2002, Vol. 44, p. 1923.
6. Bojinov, M., Kinnunen, P. & Sundholm, G. *Corrosion* 2003, Vol. 59, p. 91.
7. Betova, I., Bojinov, M., Kinnunen, P., Mäkelä, K. & Saario, T. *J. Electroanal. Chem.* 2004, Vol. 572, p. 211.
8. Bojinov, M., Kinnunen, P., Lundgren, K. & Wikmark, G. *J. Electrochem. Soc.* 2005, Vol. 152, B250.
9. Kumai, C. S. & Devine, T. M. In: *CORROSION'2001*, NACE International, Houston, 2001, paper 01 150.
10. Beverskog, B., Bojinov, M., Kinnunen, P., Laitinen, T., Mäkelä, K. & Saario, T. *Corros. Sci.* 2002, Vol. 44, p. 1901.
11. Takeda, Y., Bojinov, M., Hänninen, H., Kinnunen, P., Laitinen, T., Mäkelä, K., Saario, T., Sakaguchi, T., Shoji, T., Sirkiä, P. & Toivonen, A. *Key Engineering Mater.* 2004, Vol. 261–263, p. 925.
12. Ono, S., Haginuma, M., Kumagai, M., Kitamura, M., Tachibana, K. & Ishigure, K. *J. Nuclear Sci. Technol.* 1995, Vol. 32(2), p. 125.
13. Lister, D. H. & Venkateswaran, G. *Nucl. Technol.* 1999, Vol. 125, p. 316.
14. Repphun, G., Hiltbold, A., Mailand, I. & Stellwag, B. *Power Plant Chem.* 1999, Vol. 1. p. 18.
15. Inagaki, H., Nishikawa, A., Sugita, Y. & Tsuji, T. *J. Nuclear Sci. Technol.* 2003, Vol. 40, p. 143.
16. Hosogawa, H. & Nagase, M. *J. Nuclear Sci. Technol.* 2004, Vol. 41, p. 682.
17. Beverskog, B. In: *Proc. International Conference "Water Chemistry of Nuclear Reactor Systems"*, San Francisco, CA, October 10–14, 2004, paper 2.7 (CD-ROM publication).

18. Bojinov, M., Kinnunen, P., Laitinen, T., Mäkelä, K., Saario, T., Sirkiä, P., Betova, I. & Zaharieva, N. Modification of the high temperature titration equipment to reach relevant temperature (288°C) and to maintain constant solution composition in studying the adsorption and surface complexation of species at the oxide film/coolant interface. VTT Research Report BTUO76-031199, Espoo 2004. 14 p.
19. Bojinov, M., Kinnunen, P., Lehtovuori, V. & Saario, T. A conceptual four-layer model of the oxide layer on structural materials in LWRs with emphasis on the oxide-coolant interactions, VTT Research Report TUO75-056405, Espoo 2005. 25 p.
20. Bojinov, M. & Kinnunen, P. Kinetics of the growth and restructuring of the oxide layer on stainless steel in a light water reactor coolant, SAFIR Interim Report, VTT Research Notes 2272, Espoo 2004. Pp. 89. ISBN 951-38-6515-0; ISSN 1235-0605. <http://virtual.vtt.fi/inf/pdf/tiedotteet/2004/T2272.pdf>.
21. Stén, P., Puhakka, E., Ikävalko, E., Lehikoinen, J., Olin, M., Sirkiä, P., Kinnunen, P. & Laitinen, T. Adsorption studies on iron oxides with referenceto the oxide films formed on material surfaces in nuclear power plants. VTT Research Notes 2182. Espoo 2002. 37 p. ISBN 951-38-6177-5 951-38-6178-3. <http://virtual.vtt.fi/inf/pdf/tiedotteet/2003/T2182.pdf>.
22. Ziemniak, S. E. & Hanson, Corros. Sci. 2006, Vol. 48, p. 2525.
23. Bojinov, M., Galtayries, A., Kinnunen, P., Machet, A. & Marcus, P. Electrochim. Acta. (2006, manuscript in preparation).

6. Ageing of the Function of the Containment Building (AGCONT, 2003–2004) / Participation in the OECD NEA Task Group Concrete Ageing (CONAGE, 2003) / Safety Management of Concrete Structures in Nuclear Power Plants (CONSAFE, 2005)

6.1 Durability and Safety of Concrete Structures in Nuclear Power Plants

Erkki Vesikari & Kalervo Orantie

VTT

Abstract

This report summarises three small projects CONAGE, AGCONT and CONSAFE, all dealing with durability and safety of concrete structures in nuclear power plants. CONAGE allowed for VTT's representation in the OECD/NEA/IAGE Concrete Work Group which organises symposiums and prepares reports on ageing phenomena, degradation, monitoring and repair of concrete structures in nuclear power plants. CONAGE ended in 2003 but the participation in the work group continued in conjunction with other SAFIR projects. AGCONT, in 2004, focused on studying degradation phenomena in concrete structures of nuclear power plants and identification of critical concrete structures specifically in the Olkiluoto and Loviisa power plants. In addition an estimation was made on the behaviour of concrete structures during severe accidents (LOCA) from the viewpoint of durability and safety. The third project CONSAFE was directed towards a safety management system of concrete structures in nuclear power plants. CONSAFE started in 2005 and continued in 2006 as a subtask in the project CONTECH. A description and an implementation plan for the safety management system was prepared.

Introduction

The durability and safety of concrete structures in nuclear power plants have been raised as a prime issue in recent years as the original operating licences of NPPs approach their end. An extension to any operating licences would require that the NPP structures will work reliably and safely even after the prolonged operating period. Accordingly, it is important to be aware of the main degradation phenomena and to identify the critical structures that may be exposed to environmental stresses and degradation. Also it is

important to be able to manage the possible degradation problems by predicting the behaviour of structures and possible intervention actions for the whole planned operating time.

Main objectives

- Participation in the activity of OECD/NEA/IAGE Concrete Work Group. (CONAGE)
- Report on aging of concrete structures in nuclear power plants. (AGCONT)
- Description and implementation plan for the safety management system of concrete structures in nuclear power plants. (CONSAFE)

Main results

Participation in the activity of OECD/NEA/IAGE Concrete Work Group (CONAGE)

The OECD/NEA/IAGE Concrete Work Group was established to maintain and promote international activity in the area of structural integrity and aging of concrete structures of nuclear power plants. This group works under the Committee on the Safety of Nuclear Installations (CSNI) which co-ordinates the NEA activities concerning the technical aspects of design, construction and operation of nuclear installations. The IAGE work group prepared a programme of workshops to address specific technical issues in three levels of priority (see Table 10).

Table 10. Prioritised technical issues.

Priority	Issue
1	<ul style="list-style-type: none"> • Loss of prestressing force in tendons of post-tensioned concrete structures • In-service inspection techniques for reinforced concrete structures having thick sections and areas not directly accessible for inspection
2	<ul style="list-style-type: none"> • Viability of development of a performance-based database • Response of degraded structures (including finite element analysis techniques)
3	<ul style="list-style-type: none"> • Instrumentation and monitoring • Repair methods • Criteria for condition assessment

Several international workshops were arranged by the IAGE Work Group in the years 1997–2004. In addition to papers presented in workshops, the reports contain a summarisation of conclusions drawn from these workshops as well as recommendations to provide an improved understanding of the long-term behaviour of concrete structures.

In 2003–2006 VTT's representative participated in the activity of the IAGE Concrete work group through SAFIR financing. A short memorandum from the meetings was prepared in Finnish [1].

State-of-the-art on aging of safety related concrete structures in nuclear power plants (AGCONT)

Many concrete structures in nuclear power plants are known to be exposed to rather severe environmental conditions. However, the thick sections and difficult accessibility of structures restrict the use of both non-destructive and destructive methods during inspections. The critical concrete structures in nuclear power plants contain a lot of normal reinforcement steel and prestressing steel. Because of the heavy reinforcement, sampling from structures is difficult and inadvisable.

The general degradation phenomena in concrete structures of nuclear power plants are discussed in the report [2]. The critical concrete structures exposed to the degradation phenomena are identified in both Olkiluoto and Loviisa power plants. The aging and inspectability of structures are evaluated and an estimation of the behaviour of these structures during an accident (LOCA) is presented. Two groups of structures are the main focus: sea water channelling structures and reactor containments.

Sea water channelling structures are exposed to the following stresses:

- The penetration of chlorides in concrete below the water level and immediately above it (splash zone).
- Abrasion of running water below the water level.
- Carbonation of concrete above the water level.
- Chemical attack of chlorides in ground water on the prestressed rock anchors.
- The frost attack and frost-salt attack on concrete in outlet parts of the sea water channels.

Containment structures are exposed to the following stresses:

- Relaxation of prestressing in concrete containments and fuel basins.
- Creep of concrete in containments and fuel basins.
- Brittle behaviour and detachment of coatings.
- Aging of steel liners of water reservoirs within the containment.
- Aging of seals in hatches and inlets of the containment.

In general the damages observed in nuclear power plants are associated with inadequate tightness of containment (seals etc.), corrosion of steel parts of containment, relaxation

of prestressing, stress corrosion cracking in anchors, failure of single tendons and detachment of coatings.

Description and implementation plan for the safety management system of concrete structures in nuclear power plants (CONSAFE)

The Service Life Management System is a tool for predicting the condition of structures over a long design period, planning and organising all intervention actions related to the upkeep of structures and evaluating the costs and environmental impacts of the intervention actions over the design period. The intervention actions include maintenance and repair actions and in special cases rehabilitation and renewal. The inspection system of structures and the upkeep of a database are interlinked with the Service Life Management System. A life cycle cost (LCC) analysis and a life cycle assessment (LCA) analysis are determined from the whole design period while also the annual costs are evaluated. Other services such as structural analyses, qualitative and quantitative risk analyses, and automatic decision making aids are also added to the system.

The Service Life Management System (Figure 47) fulfils the requirements presented in the Finnish Regulatory guide YVL 1.1, which states that “a plan shall be presented for how the design and qualification of the components and structures, their operation and operating experience, in-service inspections and tests, and maintenance are integrated so as to form a comprehensive ageing management programme.”

The system provides the utility of a plant with the following information [3]:

- present condition state of structures,
- predicted condition of structures over the licensed operating time,
- predicted service life of structures,
- predicted maintenance and repair actions and their timings during the whole operating time, and
- costs of maintenance and repair actions.

Using the Service Life Management System, the administration of a NPP can convince and persuade authorities that the concrete structures in the NPP fulfil all the requirements of performance and safety. They are also able to design the upkeep of structures in such a way that the requirements will be fulfilled during the whole licensed operating time. For maintenance staff and designers the Service Life Management System specifies and times all the maintenance and repair actions throughout the operating time so that they can be systematically taken into account in the annual action and resources plans.

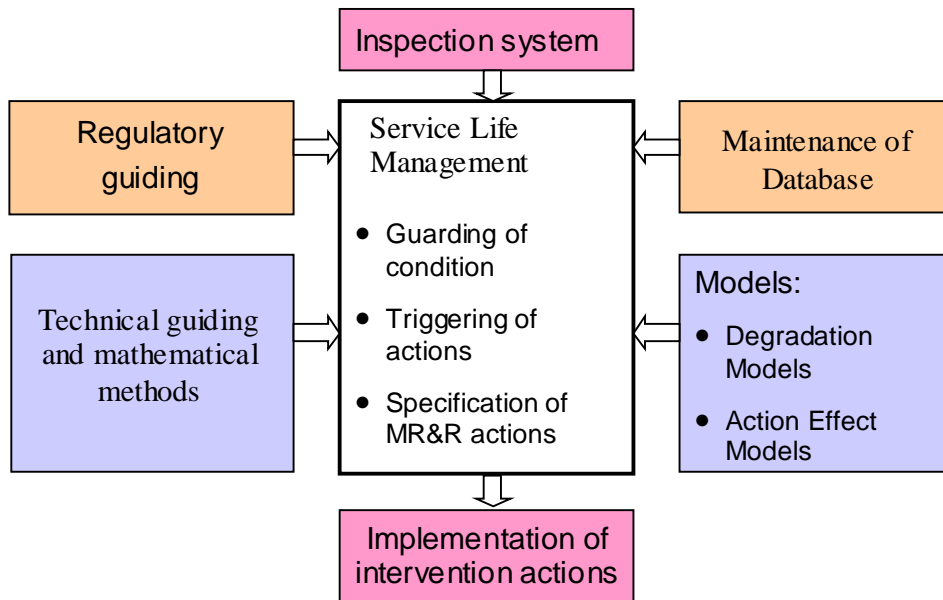

Figure 47. Scheme for the Service Life Management System.

Applications

The results of the three projects are to be utilised in the safety management system of Finnish nuclear power plants, which is planned to be implemented during the research program SAFIR 2010.

Conclusion

The three projects reply to the call for better understanding on aging problems of concrete structures in nuclear power plants. The key issues are identification of the most exposed concrete structures in nuclear power plants, inspection and condition assessment of structures, prediction of future condition and possible intervention actions during the planned operating time and the evaluation of possible risks.

References

1. Vesikari, E. Memorandums of OECD/NEA/IAGE Concrete Work Group meetings 2003–2006. (In Finnish).
2. Orantie, K. 2004. Suojarakennustoiminnan ikääntyminen, State of the Art. Rasitukset ja käyttäytyminen onnettomuustilanteessa. (State of the art on aging of reactor containments. Stresses and behaviour during accident). VTT Building and Transport. Internal Report RTE40–IR–25/2004. 25 p. (In Finnish).
3. Vesikari, E. 2006. Service life management system of concrete structures in nuclear power plants. VTT Research Report VTT-R-10904-06. 41 p.

7. Concrete technological studies related to the construction, inspection and reparation of the nuclear power plant structures (CONTECH)

7.1 CONTECH summary report

Liisa Salparanta
VTT

CONTECH is a concrete research project that has been going on since 1992. Every year a consortium that has changed a little during the years decides which topics are studied. The consortium consists of the Finnish Road Administration, The Finnish Rail Administration, cities and during the last four years State Nuclear Waste Management Fund has replaced Radiation and Nuclear Safety Authority. Also companies participate the project every now and then.

CONTECH consists of several smaller practical projects dealing with concrete structures. During the years 2003–2006 some 30 projects have been carried out.

Examples of topics that have been studied:

- internal curing agents of concrete,
- very rapid hardening grouts,
- maximum harmless extent and type of rust on reinforcement bars during construction,
- cathodic protection of reinforcement have been studied,
- cumulation of salts in concrete,
- quality requirements and verification methods of concrete protective agents,
- non-destructive testing methods of reinforcement corrosion
- pretreatment of concrete surface for hydrophobic impregnation
- quality requirements and verification methods of concrete curing agents
- quality requirements of self-compacting concrete
- quality requirements of form liners and their usage
- effect of form liners and hydrophobic impregnation on chloride permeability.

The results obtained are directly applicable in practice. E.g. directions and specifications are made on the basis of the test results.

7.2 Very rapid hardening mortars, grouts and concretes

Pertti Pitkänen
VTT

Abstract

The applicability of a very rapid hardening grout for grouting joints between concrete slabs and steel piles was studied. On the basis of all the test results: castability, vibration limit, heat generation, strength development and shrinkage the grout RAPI-tec® pva/pav turned out to be suitable for the purpose.

Introduction

The aim of the study was to determine essential properties of a very rapid hardening grout from the reparation point- of- view. The trade name of the grout was RAPI-tec® pva/pav.

Tests

The following properties were studied:

- Vibration limit, SFS 5289
- Temperatures during hardening
- Strength development, SFS 4474
- Unrestrained shrinkage
- Detachment from the mould.

In addition, the placeability and behaviour of the grout were observed.

Test specimens

Cubes measuring $100 * 100 * 100 \text{ mm}^3$ and prisms measuring $40 * 40 * 160 \text{ mm}^3$ were cast for testing strength development and shrinkage, respectively. A Steel mold, as shown in Figure 48 and Figure 49, was used for measuring temperatures during hardening and for observing the detachment of the grout from the mold. The mold was filled in two portions. The inner steel tube was filled first and two months after the outer tube was filled.

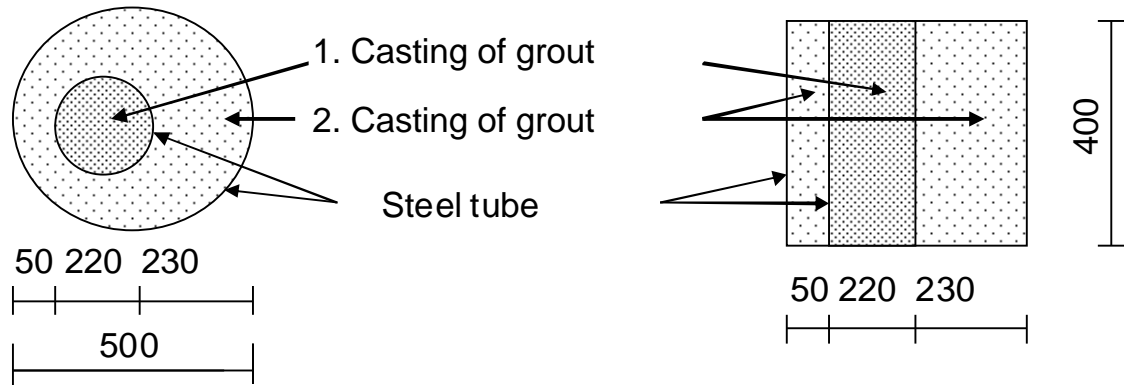

Figure 48. Dimensions of the mold, mm.



Figure 49. Mold before and after castings.

Results

Castability of the grout was good.

No bleeding was observed.

Vibration limit was reached 42 min after water addition.

Temperature measurements in the center of the inner and outer tubes were started simultaneously with castings. In the first casting of the inner tube the temperature rose up to +39,5°C in ca. 3 h. In the second casting of the outer tube the temperature rose up to +50°C in ca. 2 h.

The results of compressive strength measurements and the strength values given by the manufacturer are shown in Table 11.

Table 11. Compressive strength.

Age	Compressive strength, MPa	
	Measured	Given by the manufacturer
3 h	16,9	24
6 h	18,9	-
1 d	25,6	37
2 d	25,5	-
7 d	62,1	53
28 d	75,7	68

Strength development during the first day was considerably lower and after that considerably higher than declared by the manufacturer. The strength at the age of 28 d was 11% higher than declared by the manufacturer.

The results of unrestrained shrinkage measurements of three specimens are shown in Figure 50.

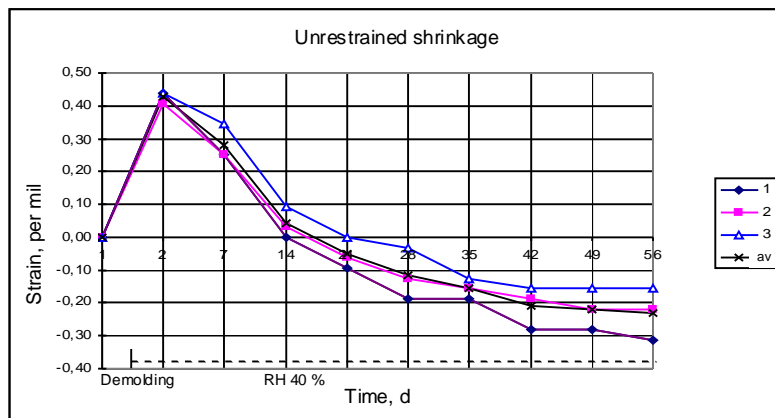

Figure 50. Unrestrained shrinkage.

No detaching of the hardened grout from the mold was observed.

Conclusions

Vibration limit was on the safe side compared to that given by the manufacturer.

Heat generation was rapid in the beginning of the hardening. This was as expected because heat normally develops normally during hardening due to cement hydration.

The very rapid hardening grout RAPI-tec® pva/pav is suitable for grouting joints between concrete slabs and steel piles.

8. The integration of thermal hydraulics (CFD) and finite element (FEM) computer codes in liquid and solid mechanics (MULTIPHYSICS)

Ville Lestinen & Jukka Kähkönen
Fortum Nuclear Services Ltd

Antti Timperi, Timo Pättikangas & Markku Hänninen
VTT

Abstract

The main objective of the project is to improve modeling capabilities for Fluid-Structure-Interaction (FSI) systems. The FSI problems are very common in industry, and there is a growing need to develop simulation tools for these problems. An important application in nuclear industry is the structural integrity of nuclear reactor core internals in Design Basis Accident (DBA). The specific case studied in the project is Large Break Loss of Coolant Accident (LBLOCA) and especially the pressure transient, which is caused by the guillotine pipe break. Tools used for the analysis are Computational Fluid Dynamics (CFD) and Finite Element stress and strain Analysis (FEA) codes. An original aim of the project was to study the possibility to develop one numerical model for system geometry with suitable meshing for all physical analysis, including both CFD and FEA modeling. However, quite soon it was noticed that the common meshing would decrease the quality of both analyses too much. The goal was updated to couple the separate CFD and FEA calculations through internal or external interpolation code. The FEA codes used in this work are NASTRAN and ABAQUS. The codes FLUENT and STAR-CD were used in the CFD side. The coupling was made using the internal coupling model ES-FSI of the STAR-CD and external interpolation code MpCCI. Boundary conditions in the pipe break were calculated using system codes.

Introduction

The LBLOCA is an important DBA case in nuclear industry. In Finnish nuclear safety requirements it is stated that the reactor internals must be able to keep their structural integrity in a case of the LBLOCA, which is a FSI problem. The FSI phenomenon means that forces caused by the fluid flow are moving or deforming the structures. Coupling of CFD and FEA codes seems to be a promising method of analysis in a case of FSI problems. To minimise overestimations in structural forces, two-way coupling between CFD and FEA should be used.

At the beginning of the project the capability of CFD codes to calculate propagation of the pressure wave in the fluid was tested. Testing was made in three steps. In the first step the pressure wave propagation in the 2D pipe was calculated. Then a partial 3D model with one cold leg was used. The final test calculations were made with the 3D model including the downcomer and all six cold legs. [1, 2]

The first step in FSI analyses is to define the pressure loads to the structures. In this work the loads are calculated using CFD codes. Limitation of the commercial CFD codes is the incapability to calculate the possible phase transitions. However, the APROS calculations made in this project show that there is a short delay before the phase transition begins and the pressure returns to the saturated state after the break in LBLOCA. As it is supposed that the highest structural loads occur immediately after the break due to the first and the largest pressure drop, the simulation of the beginning the LBLOCA can be handled as one-phase case. [3]

In the second step in FSI analyses the structural stresses are calculated using the FEA code. The pressure loads calculated with CFD are coupled to FEA calculations using one-way coupling or fully (two-way) coupled models. In the realistic case the pressure hit on the core barrel wall causes movements and deformations to the structures, which may decrease the force of the hit compared to case with the rigid core barrel wall. The moving walls were taken into consideration using two-way coupling of the CFD and FEA codes [4].

System code calculations

In this work system codes APROS and TMOC were used. The main calculations were made with APROS and some additional reference calculations were made with TMOC. [5, 6]

The six-equation solution system is used in APROS calculations. In the six-equation model of APROS, the flashing of the superheated liquid is calculated by multiplying the enthalpy difference with an experimental correlation [7]. The pressure undershooting is treated with a relatively simple formula. In this formula, the evaporation is delayed when the liquid superheating is small and steam void fraction is less than 0.02.

A detailed APROS model of Loviisa NPP, developed at Fortum Nuclear Services, was used in the calculation. The model comprises the process of the whole power plant. In this simulation exercise, the initial phase of the LBLOCA, the broken main circulation pipe, the downcomer of the reactor pressure vessel and the plenum below the core form the most important area. The length of the main circulation pipe from the break position to the reactor pressure vessel was 0.4 m. This pipe was divided into 4 nodes with equal lengths. The downcomer of the pressure vessel was in vertical direction divided into six

parts. In circumference direction the downcomer was treated as one channel. The plenum below the reactor core was divided into four nodes. At the start of the LBLOCA, the plant was assumed to run at the nominal state. The pressure in the cold leg was 124.9 bars and the coolant temperature was 265.6°C. The mass flow in each of six loops was 1413 kg/s. The break was initiated by setting the pressure of the node in the break to 1 bar and defining the node to be out of the simulation. The break was assumed to open in 0.2 ms.

In Figure 51, in the upper left part, the pressure behavior in the broken pipe during the first 20 ms is shown. The pressure minimum at the position of 10 cm from the break is about 27 bars. Already in the next node the pressure minimum is clearly higher (45 bars) and in the third node the pressure decreases only close to the saturation state. In the upper right picture in Figure 51 it can be seen also that near the break the steam formation starts very soon after the pipe rupture. In the downcomer and lower plenum, no vaporization was observed. The discharge mass flow is shown in Figure 51 in lower left picture. The flow in the pipe near the reactor pressure vessel reversed in less than 1 ms and the discharge mass flow achieved its maximum 10600 kg/s in 40 ms. In lower right part of Figure 51 the pressures in the top, middle and bottom of the downcomer and in the lower plenum are shown. As can be seen the depressurization wave propagates towards the core and at about 10 ms the pressure at the core bottom starts to decrease. In evaluating the pressure wave behavior it should be taken into account that the system code, which applies the finite difference method, has such a deficiency that the numerical diffusion smoothes the pressure changes.

Because the first pressure drop is essential in the CFD calculation of pressure loads, the calculation results are discussed in more detail in Reference [8]. The deepness of the first pressure drop as a consequence of the pipe break depends on the depressurization rate and on how fast the superheated liquid will evaporate. When the depressurization is fast, as it is in the pipe rupture, the pressure drops clearly below the saturation state, i.e., the pressure undershoots.

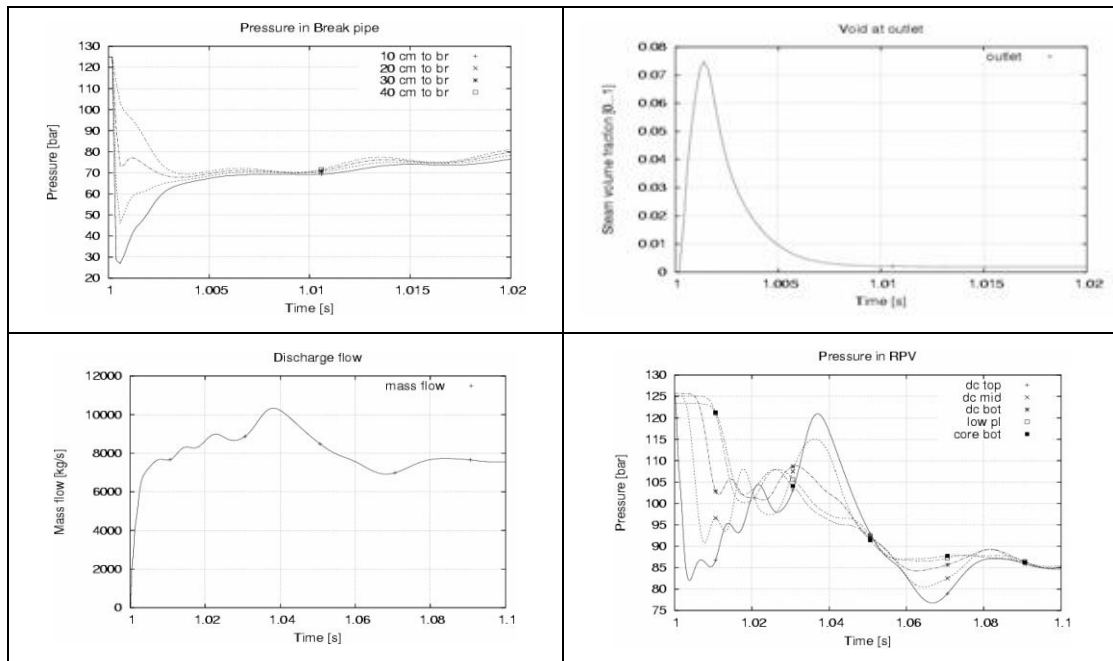

Figure 51. Upper left: Pressures in the broken pipe. Note that the break occurs at time $t = 1$ s. Upper right: Steam volume fraction near the break. Lower left: Discharge mass flow from the pressure vessel side. Lower right: Pressures in the downcomer and lower plenum of the reactor pressure vessel.

In addition TMOCS system code calculations were made. The length of the main circulation pipe from the break position to the reactor pressure vessel was 0.5 m. This pipe was divided into 4 nodes with equal lengths. All other cold leg inlet pipes were modelled separately as well as all six hot leg pipelines were included in the model. In addition the secondary circuit was modelled. The APROS and TMOCS results were partly different. However, reasons for the differences are not yet completely analysed, so TMOCS results are not presented in this paper.

FSI calculations

The propagation of the pressure transient initiated by a guillotine break of one of the cold legs was simulated by coupled calculations by using the CFD codes FLUENT 6.2 and Star-CD 3.15 and the structural analysis code ABAQUS 6.5 [9, 10, 11]. The external interpolation code MpCCI was used to couple the FLUENT and ABAQUS codes [12]. The ES-FSI software of Star-CD was used for coupling Star-CD and ABAQUS. When the sudden break in the cold leg occurs, the pressure decreases rapidly and a depressurization wave propagates from the break location into the downcomer of the reactor vessel. The pressure wave propagating with speed of sound reaches the bottom of the pressure vessel within about ten milliseconds and then enters into the reactor core. During the first tens of milliseconds after the pipe break, the sudden

pressure drop induces outward motion of the core barrel, which affects the pressure in the downcomer and in the reactor core. In the downcomer, the outward motion of the core barrel partly suppresses the pressure drop caused by the pipe break. In the reactor core, the outward motion of the core barrel decreases the pressure. This effect decreases the load on the core barrel caused by the first pressure transient after the pipe break.

Single-phase CFD simulations of the pressure transient were performed. The two-phase effects were only taken into account via the boundary conditions at the break position which were obtained from the system code simulations. After the pressure drop, a few milliseconds are needed for nucleation and development of steam bubbles before significant amount of steam is formed inside the pipe. According to the APROS simulations, the void fraction remains very small during the first ten milliseconds after the pipe break. During this time, the void fraction is significant only in the vicinity of the break point. Therefore, it seems that at least the propagation of the pressure transient in the early phase of the LBLOCA can be described with single-phase simulations. The numerical meshes used in the CFD calculations consisted of the downcomer and six cold legs. The pipe break was modelled with a pressure boundary condition, where the pressure decreases in a prescribed manner at the break position. Simple linear structural models of the core barrel of the reactor were also used. The reactor internals were not included in the models used so far, but will be included in the model in the future.

STAR-CD – ABAQUS calculation

The ES-FSI code of Star-CD was used for two-way coupling of the CFD and structural analysis with Star-CD and ABAQUS. ES-FSI allows FSI analysis without the need of simultaneous coupling of CFD and FE codes. The mass, damping and stiffness matrices of the structure are first calculated by substructure analysis in ABAQUS. These matrices are then used by ES-FSI to solve the deformations of the structure during the CFD calculation. The method used by ES-FSI is limited to problems where the structure has fully linear behaviour. In addition, there are practical limitations on the size of the substructure due to the large memory requirement of the substructure analysis. Due to this Star-CD ABAQUS linking is made using MpCCI code later in project. However, the results are shown from ES-FSI calculations.

Star-CD calculations were performed both by taking into account FSI and by assuming rigid wall of the core barrel. In Figure 52, the absolute static pressure is presented in the downcomer at selected instants of time for the two simulations. It can be seen that taking FSI into account has a considerable effect on the pressure. Although the displacements of the core barrel wall were not large, considerable effect on the pressure was found because of the acoustic nature of the problem. Figure 53 presents the outer surface von Mises stress distribution and the deformed shape of the core barrel for the

FSI calculations. The maximum von Mises stresses in wall of the core barrel were approximately 270 and 415 MPa with the APROS boundary conditions. Hence, the yield strength of the wall material was exceeded. The amplitude and frequency of the motion of the core barrel wall were lower for the FSI simulation compared to the simulation with one-directional coupling, as was expected. Maximum displacements of the core barrel were approximately 9 and 13 mm for the FSI and one-directional simulations, respectively.

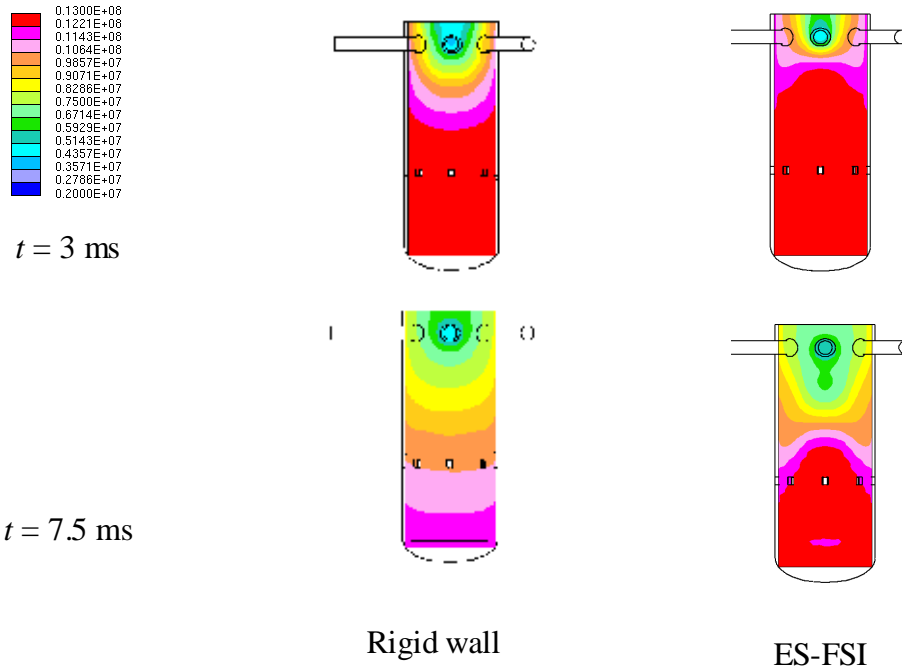

Figure 52. Absolute static pressure (Pa) in the downcomer at different instants of time for the rigid wall CFD and ES-FSI calculations with the TMOC boundary condition.

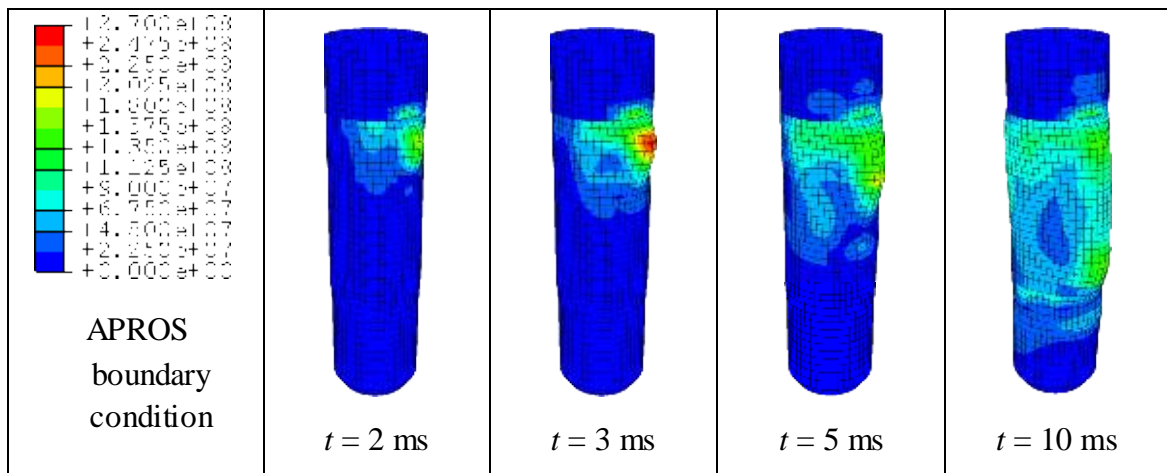

Figure 53. Von Mises stress (Pa) distribution on the outer surface of the core barrel at different instants of time calculated with the APROS boundary condition (top).

FLUENT – ABAQUS calculation

Coupling of FLUENT and ABAQUS is also started. These codes are coupled with external interpolation code MpCCI [9]. The structural loads and movements of the core barrel are calculated in ABAQUS. The wall movements are returned back to the CFD and new pressure field calculations are made in FLUENT. This coupled calculation process is continued until the desired calculation time is reached. [8]

The coupled calculations were started with the test case, which was T-junction. In this test case the pressure jumped in the inlet from the 0 to 200 bar during 0.4 s. The target was to test the functionality of the MpCCI code. The test was successful and after this the FSI calculations using 3D reactor model were started. The calculated geometry is further developed from Star-CD – ABAQUS calculations and it can be seen in Figure 54.

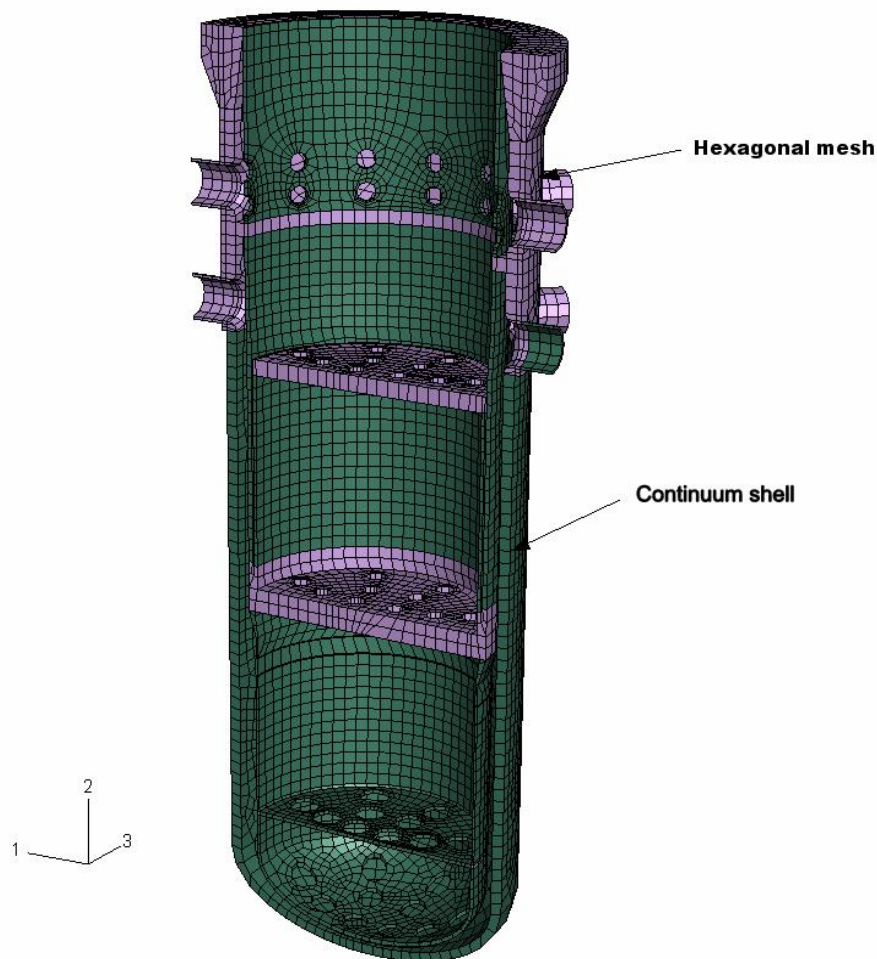

Figure 54. Developed reactor geometry.

New developed geometry includes simplified description of the reactor internals. Element types used in ABAQUS analysis were continuum shell SC8R (green color in

Figure 54) and hexagonal 8-node continuum element C3D8R. The FLUENT grid includes hexagonal mesh for the fluid parts. First calculations have been made, but results are preliminary and still need further validation and are not presented in this paper. Calculations should be finished at the end of the year 2006 and they will be reported after that.

FEA analyses with acoustic elements

Msc. NASTRAN is a commercial FEA code, which was used at the beginning of the project to calculate the pressure transient inside the reactor pressure vessel in the LBLOCA case. Calculations were performed by ENPRIMA. The NASTRAN model used in the project was based on the model, which includes whole primary loop of Loviisa Nuclear Power Plant (NPP). However, in this work only the reactor pressure vessel with its internals was included in the calculation. The pressure drop was given as a boundary condition on the pipe cross-section surface just before the cold leg pipe inlet to the reactor. Pressure and deformation fields were coupled and solved simultaneously, thus FSI was taken into account in the analysis. The calculation was based on the acoustic elements. In the beginning the method was validated against the test cases calculated in Reference [1]. The results appeared a bit surprising and the conclusion was that the pressure field should be calculated also by another method.

In addition to NASTRAN calculations and to the coupled CFD calculations, FSI analyses of the LBLOCA were carried out also entirely in ABAQUS. Coupled acoustic-structural analyses were carried out, in which FSI was taken into account. In this method, water is modelled with acoustic elements and pressures and displacements are coupled on the fluid-structure interface. Interpolation was used for transferring the quantities between the acoustic and structural meshes. The pressure wave propagation in the ABAQUS calculation with acoustic elements was very similar to the CFD calculations. Left picture in Figure 55 shows the absolute static pressure on the wall of the core barrel near the broken leg for the CFD and acoustic FE simulations. Displacements of the core barrel obtained with the two simulations are compared in right picture of Figure 55. It can be seen that the results obtained with the two different models agree well with each other. In late phase of the simulation, some difference in the pressure near the broken leg between the CFD and acoustic models was found. This was due to the relatively high outflow velocity of water at the break location in the late phase, which is not taken into account in the acoustic model.

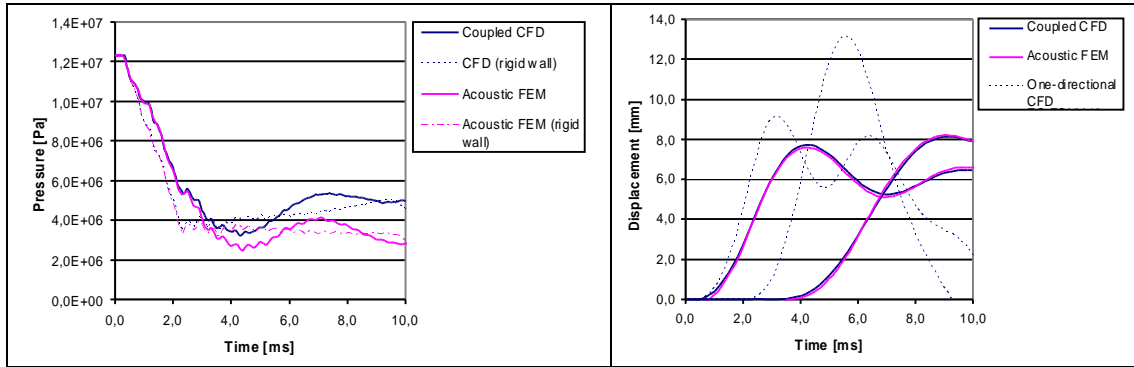

Figure 55. Left: Absolute static pressure on the wall of the core barrel at the location of the broken leg. Right: Outward displacement of selected nodes of the core barrel.

Conclusions

In this project, calculations of the FSI problem using coupled CFD and FEA codes have been carried out. The codes used in the work are NASTRAN, ABAQUS, FLUENT, Star-CD, APROS and TMOG. The application for the developed methods in this project is the LBLOCA.

Boundary conditions for the pipe break were calculated with the system codes APROS and TMOG. There were some differences in the results of these two codes. The reason is still partly unclear, but the codes use different models for calculation of sound velocity and also flashing models are different. In addition noding was not similar in these cases. Analysis of the differences is in progress.

The NASTRAN and ABAQUS codes with acoustic elements were tested for LBLOCA FSI case. The NASTRAN model was able to calculate the pressure transient, but the results seem to be at least partly little bit questionable. It is possible that the acoustic wave model used in NASTRAN calculations is not suitable for this case and there could also be problems in meshing. Similar calculations were made also with ABAQUS code. These results were in good accordance with fully coupled CFD – FEA calculations. So, when the modelling is made carefully also FEA codes alone with acoustic elements seem to be capable to give useful results in FSI cases.

The FSI calculations with coupled FEA and CFD codes were made. Two linking methods were tested: internal ES-FSI model of Star-CD and external interpolation code MpCCI. Both methods worked well. The pressure load was first analysed by a single phase CFD calculation. These pressure loads were transferred to the FEA code and wall movements were calculated. After these new wall locations were returned to the CFD code and the pressure field was recalculated and so on. Results seem to be reasonable, but validation is still needed to guarantee the reliability of the results. Validation against experiments is the next step of the MULTIPHYSICS project.

References

1. Pättikangas, T., Raussi, P., Pokela, H. & Huttunen, M. 2000. Two-Dimensional CFD Simulation of Water Hammer in a Pool, Research Report ENE6/26/00. Espoo: VTT Energy. 26 p.
2. Lestinen, V. 2006. MULTIPHYSICS, Joint CFD-FEM Calculations of Pressure Transient in LBLOCA Using FLUENT and ABAQUS., TERMO-515. Espoo: Fortum Nuclear Services. 27 p.
3. Pättikangas, T. & Timperi, A. 2004. CFD and Structural Analysis of the Pressure Transient in the Beginning of a Large-Break LOCA in a PWR., Research Report BTUO72-041302. Espoo: VTT. 41 p.
4. Pättikangas, T., Timperi, A. & Hänninen, M. 2005. Joint CFD-FEM Calculations of Pressure Transient in LBLOCA Using APROS, Star-CD and ABAQUS., Research Report TUO72-056661. Espoo: VTT. 68 p.
5. Miettinen, J., Karppinen, I., Hänninen, M. & Ylijoki, J. 1999. Evaluation of two-fluid and drift flux thermohydraulics in APROS code environment, VTT Symposium 194. Proc. 2nd CSNI Specialist Meeting on Simulators and Plant Analysers. Espoo, Finland, 29 Sept – 2 Oct., 1997. VTT. Espoo (1999). Pp. 378–389.
6. Siikonen, T. 1983. A short description of the computer code TMOC, VTT Research Notes 257, Espoo, Finland. 70 p.
7. Bestion, D. 1990. The physical closure laws in the CATHARE code. Nuclear Engineering and Design, Vol. 124, No. 3, pp. 229–245.
8. 2006 ASME Pressure Vessels and Piping Division Conference. Proceedings of PVP2006-ICPVT-11 July 23–27, 2006, Vancouver, BC, Canada.
9. FLUENT ANSYS, 2006. <http://www.fluent.com/>.
10. CD-adapco, Star-CD, 2006. <http://www.cd-adapco.com/>.
11. ABAQUS Inc. <http://www.abaqus.com/>.
12. MpCCI, 2005. www-manual of MpCCI code. <http://www.scai.fraunhofer.de/592.0.html>.

9. The Integral Code for Design Basis Accident Analyses (TIFANY, 2003) / APROS modelling of containment pressure suppression systems (TIFANY, 2004) / Development of APROS containment model (TIFANY, 2005) / Validation of APROS containment model (TIFANY, 2006)

9.1 TIFANY summary report

Mika Harti

Fortum Nuclear Services Ltd.

Abstract

This report summarizes the research and development activities performed in the TIFANY project from 2003 until November 2006. The aim of the project has been mainly to develop and validate the APROS containment model, but improvements have been also made in the thermal hydraulic model of APROS. The aim of the project has been shifted from the integration of thermal hydraulic part and containment part in 2003 through model development to validation of the containment model in 2006. This report summarizes the work and presents some selected results.

Introduction

The TIFANY project started in 2003 and has been continuing yearly to 2006. The primary aims of the project were to integrate primary circuit and containment calculation, improve the thermal hydraulic and especially containment model of APROS and to validate the models against experimental or plant based data. The TIFANY project with other APROS related projects has improved APROS simulation code and especially its containment part for the use of Radiation and Nuclear Authority in Finland, VTT Technical Research Centre of Finland, utilities and APROS users abroad. The project has also helped marketing of APROS containment model and thereby supported the existence and development of high tech know-how in Finland. As a prove of applicability and ability of APROS is the fact, that the licensing analyses related to application of operating license for the Loviisa Power Plant were carried out using APROS in 2006.

The TIFANY projects involved Tekes, utilities Fortum and Teollisuuden Voima (TVO) as financing organizations and Fortum Nuclear Services (FNS) and VTT as working

organizations. TVO provided valuable information on boiling water reactors and the new EPR unit at Olkiluoto site.

Description and some selected results of 2003 and 2004 projects are presented in the interim report of SAFIR programme [1]. Therefore only the main objectives from these years are presented in this report.

Main objectives

TIFANY 2003: The Integral Code for Design Basis Accident Analysis

Traditionally, the design basis accident analyses for reactor cooling system and containment system have been separate, although the systems are thermal hydraulically connected during the accident. On the containment side, the analyses are usually based on blowdown curves calculated with the primary circuit model alone assuming that the containment is in a stable thermodynamic state.

The main objective of TIFANY in 2003 was to create and validate a generic integrated APROS calculation model for design basis accident analyses in various types of NPP's. A fully-integrated calculation approach is necessary for analyzing the behavior of various passive reactor and containment safety systems.

The lack of a simulation program integrating primary circuit thermal hydraulics and containment thermal hydraulics was at that time an internationally recognized problem. Because of this lack, it was decided by VTT and Fortum that such a feature should be added to APROS.

In addition to the development of the interface between APROS 5- and 6-equation model calculation and containment calculation, an objective was set to create generic integrated PWR and BWR plant application models including both a model of the primary circuit and the containment. The project was also aiming at validating recombiner and spray submodels of the APROS containment calculation and checking and correcting the correlations used in the APROS containment model and six-equation thermal hydraulic model to cover the needs of DBA analyses.

TIFANY 2004: APROS Modeling of Containment Pressure Suppression Systems

During TIFANY in 2003, a number of flaws and improper implementations of modeling were detected in the APROS containment model. Especially, improvements to the pressure suppression system modeling were considered to be necessary in order to achieve the level required for the containment licensing analyses.

The objective of TIFANY 2004 was to improve the pressure suppression system modeling in APROS. Three topics were selected to the project: pressure suppression pool system, bubbler condenser modeling and ice condenser modeling. The first one of these is of primary interest in BWR's; the second and the third ones are interesting in special types of PWR's.

Modeling of pressure suppression pool was improved by introducing a water pool temperature stratification model to APROS. The pool stratification model allows APROS water sump module to model two temperature layers in a water pool. Also, calculations of the POOLEX pressure suppression pool experiments performed in Lappeenranta University of Technology were used to learn about the capabilities of APROS six-equation model capabilities and to test different condensation correlations.

The development of a bubbler condenser model was included in the project because of its interest as a special technical solution for pressure suppression and to improve the marketing potential of APROS toward Central and Eastern European VVER-reactors utilizing this concept. The development and validation of the bubbler condenser model is also improving the APROS containment calculation as a whole, since applying the code to various problems builds confidence in the capabilities of the code.

The aim of the APROS ice condenser model development is to implement the recognized features missing from the model, namely calculation of the free flow area, flow resistance and the temperature of the outflowing water.

In addition to these, a subproject involving the development of an advanced vertical steam generator model used in European Pressurized Reactor (EPR) was included in the project.

TIFANY 2005: Development of APROS containment model

The main aims of TIFANY 2005 were to further improve the modeling capability of APROS containment model by adding new models, to improve the boiling water reactors modeling and to validate some models against experimental results. The project was divided in four parts.

In the first part new fast calculating containment internal spray models were developed and new features, such as calculation of spray velocity and droplet splashing onto the containment structures, were added into the new and old models [2]. Old spray model and one of the newly developed models were validated against ISP-35 experiment [8], but the analyses were afterwards concluded unsuccessful due to an error in the used APROS version.

The second part included diverse containment modeling issues. First of all the applicability of condensation and evaporation models were extended to high steam concentrations [4]. Water film flow from one structure surface into another was made possible and the heat and mass transfer calculation into/from the water film was improved [2]. Existing valve components from the APROS thermal hydraulic model were extended into the containment calculation and one new valve type was added [9]. This allowed realistic construction of a plant model. Improvement of concentration modeling made it possible to model flow of different substances (especially boric acid) in the containment and this solution was also applied to the thermal hydraulic model of APROS. Different substances can then freely flow between the containment and primary circuit of a nuclear power plant.

The third part was related to boiling water reactor models. There was no possibility to model steam dryer and steam separator in the primary circuit. Correlations for steam separator were added [6] and with different parameters this model could be used to model steam dryer. In 2004 the two layer temperature stratification model for suppression pool was developed. In 2006 the model was validated [7] against two POOLEX experiments made in Lappeenranta University of Technology [10]. The experiments were specially designed for this validation purpose. Temperature stratification capabilities of APROS thermal hydraulic model were also tested for the sea water channel of Olkiluoto boiling water reactor [5]. The model behaviour was quite unstable due large areas and low flow velocities. However, stratification occurred in the model.

The fourth part was related to heat exchangers. The condensing of steam was not properly modelled. New correlations were added [3] for this purpose and compared successfully to plant based data of Olkiluoto BWR.

TIFANY 2006: Validation of APROS containment model

In recent years in TIFANY and in other projects many new features have been added to the APROS containment model. However, the validation of these models and APROS containment model in general against experimental results has not been very intense and some validation cases have not been totally satisfying. Partially this is caused by insufficient measurements in the experiments, uncertainties in the measurements or experiments and missing or insufficient models in the used APROS versions. The aim of TIFANY 2006 is to validate the APROS containment model against three experiments using the latest APROS version. Two international standard problems (ISP-42 and ISP-47) and a German Pacos Px1.2 spray experiment were selected as validation experiments. The analyses are not fully finished and the reports are in a draft-stage during the writing of this SAFIR final report.

There were also two other aims of the project besides the validation. First there was also need to expand the application of the containment model into the ventilation system by extending the basic pump component from the APROS thermal hydraulic model into the containment model. Second, the counter current flow limitation modeling was not well suited for BWR or western PWR. The correlations of APROS are tuned using results of FRIGG experiments. The experimental facility represents relatively well the fuel bundle geometry of BWR's and westerns PWR's. The work is not fully finished and the report is in a draft-stage during the writing of this SAFIR final report.

Presentation of some selected results from 2005 and 2006

Water pool temperature stratification model meant to be used for suppression pool of boiling water reactors was developed in 2004. In 2005 validation of this model [7] was made against POOLEX experiments STB-20 and STB-21 [10]. POOLEX test rig models the suppression pool of boiling water reactors. In both experiments the steam injection was kept low enough that a stable condensation occurred in the blowdown pipe outlet, i.e. there was no strong mixing in the water pool. The heating caused a convective flow along the pipe outer surface into the top of the pool creating temperature stratification. Gradually the temperature boundary moved downward as more and more warm water entered into the top layer. After switching off the heating conduction from the top layer started to heat up the cold bottom layer. As it can be seen from Figure 56, both the heat-up phase and the cooldown phase of STB-20 experiment can be modeled well with APROS. In STB-21 experiment the water was mixed up during the experiment. After the mixing up the experiment resembled STB-20 experiment, except the bottom layer was warmer. Also this experiment could be modeled with APROS relatively well, as can be seen in Figure 57.

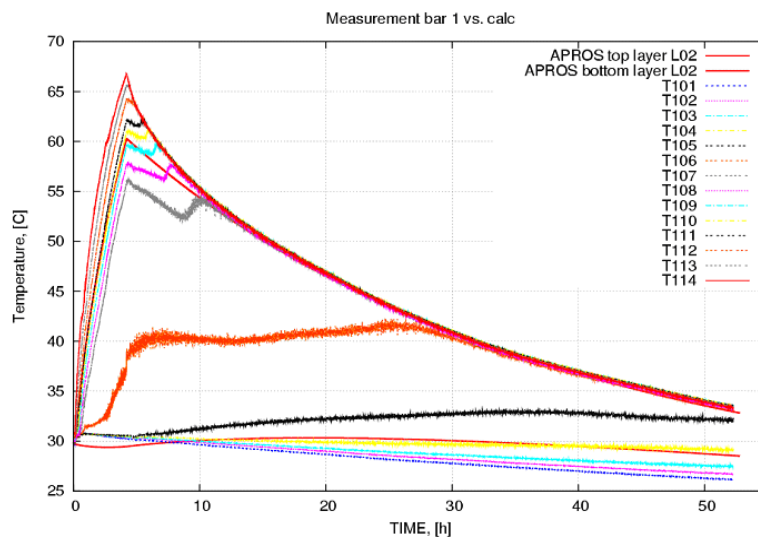

Figure 56. Validation of APROS temperature stratification model against POOLEX STB-20 experiment [7].

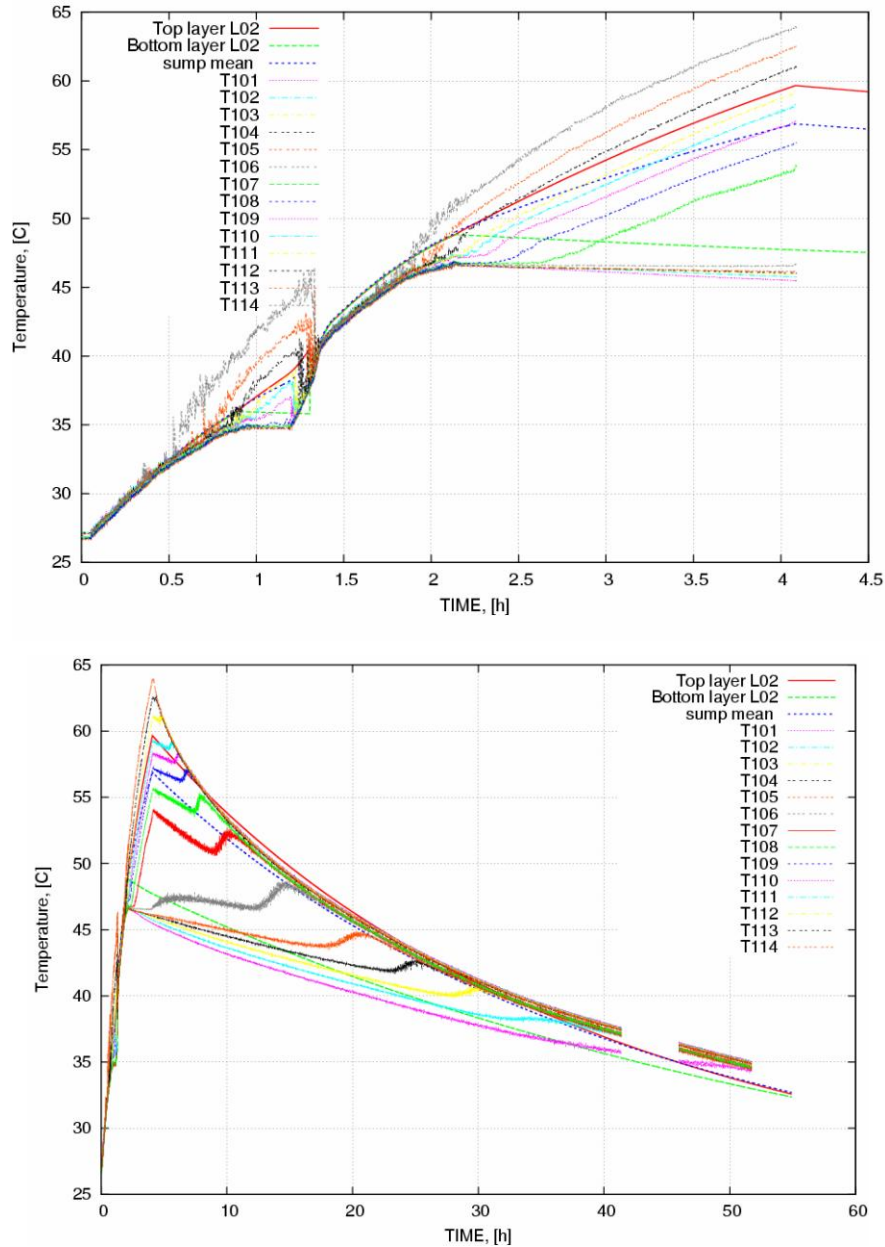

Figure 57. Validation of APROS temperature stratification model against POOLEX STB-21 experiment [7].

In 2005 existing valve components from the APROS thermal hydraulic model were extended into the containment calculation and one new valve type was added [9]. The subtask also included testing of the component behaviour in containment model and comparison of the behaviour against results of six-equation model of APROS thermal hydraulic model in order to ensure similar behaviour of the component in both models. In Figure 58 an example of the comparison is given. Results of the containment model and six-equation model differ only slightly from each others, which are explained by differences in the thermal hydraulic solution. The main difference is the wall friction which is not modelled in the solution of the containment model.

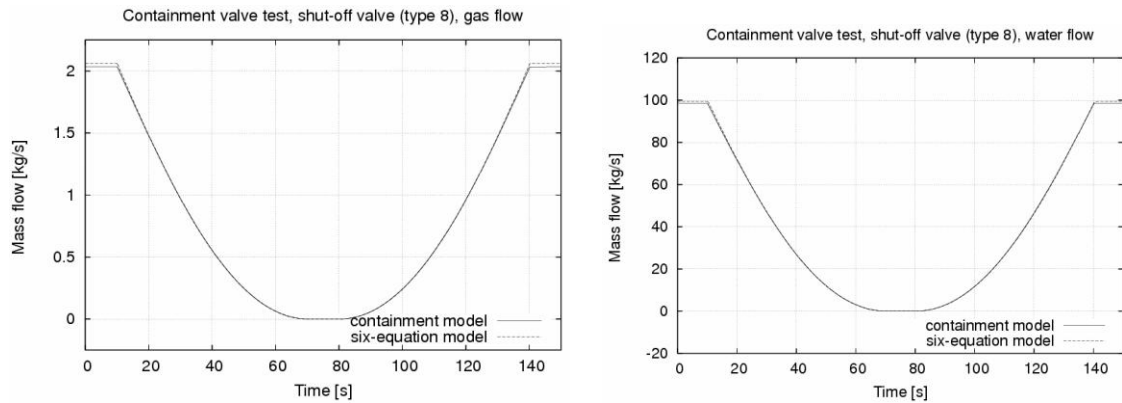

Figure 58. Comparison of shut-off valve behaviour in containment model and six-equation model of APROS [9].

In 2005 two new containment internal spray models were developed for APROS [2]. These models are called simplified spray model and equilibrium spray model. The simplified spray model resembles the older spray model, which is currently called detailed spray model. In the equilibrium spray model the spraying effectiveness is an input and no provision is given to condensation or evaporation. The aim was to create a relatively accurate fast calculating spray model, when compared to the older detailed spray model. In Figure 59 results of the test case have been presented. It can be seen that in the test case the simplified spray model is slightly less effective than the detailed spray model, but qualitative behavior is similar and the results are close to each other.

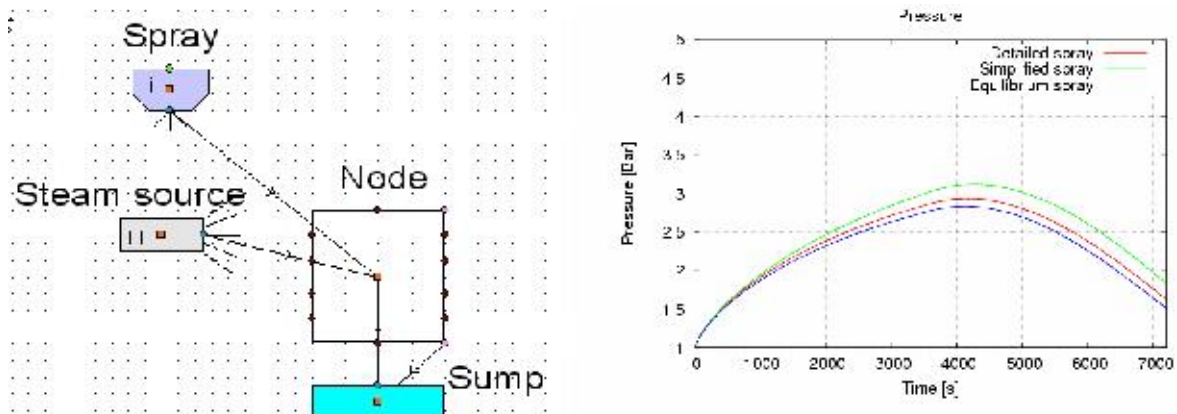

Figure 59. Testing of and comparison of new APROS spray models to old spray model (Detailed spray model) [2].

In 2005 new heat transfer correlations, which calculate the condensation on the one or several pipe rows, has been added in the APROS six-equation model [3]. Also the laminar condensation correlation for the condensation inside horizontal pipes has been implemented in the code. The new models were tested by calculating steady state values

for real BWR intermediate super-heater type exchangers with different power levels. The calculated data is compared with the measured data in Figure 60. The results, especially those at nominal power, corresponded well to the plant data and are clearly better than with the old models.

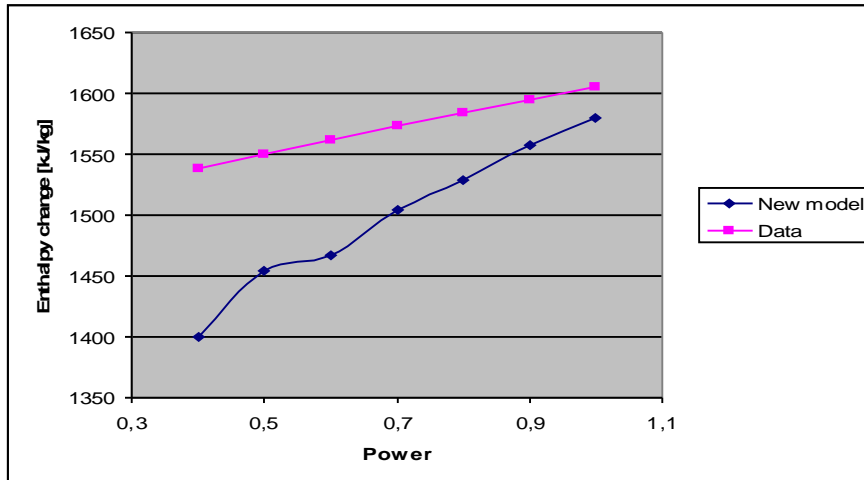

Figure 60. Calculated and reference enthalpy change as a function of the relative power.

In 2006 APROS containment model is validated against ISP-47 MISTRA experiment. The main interests are the gas convection and steam condensation. In the MISTRA experiment two steady states (steam feed and condensation in the vessel and three condensers were in equilibrium) were achieved, one in gas containing air and steam the other in gas containing air, steam and helium. The work is still ongoing, but preliminary results are already available.

Three APROS nodalizations were made in order to study the effect of nodalization in the results. Preliminary pressure behaviour curve of 12-node case is presented in Figure 61. The preliminary results indicate that the pressure behaviour and total condensation of the experiment can be calculated with APROS with good accuracy. However, APROS is a lumped-parameter code and modelling of stratification, local flow fields and jet entrainment is problematic in this kind of codes. These phenomena have influence on the steam condensation in the three condensers and in APROS in most cases the distribution of steam condensation between the condensers is relatively even while in the experiment the distribution was steeper. In APROS and in the experiment, most steam is condensed in the upper condenser. Preliminary comparisons of results with different nodalizations have also been made. The nodalization affects to the distribution of condensation, but the effect is only minor to the total condensation rate and pressure.

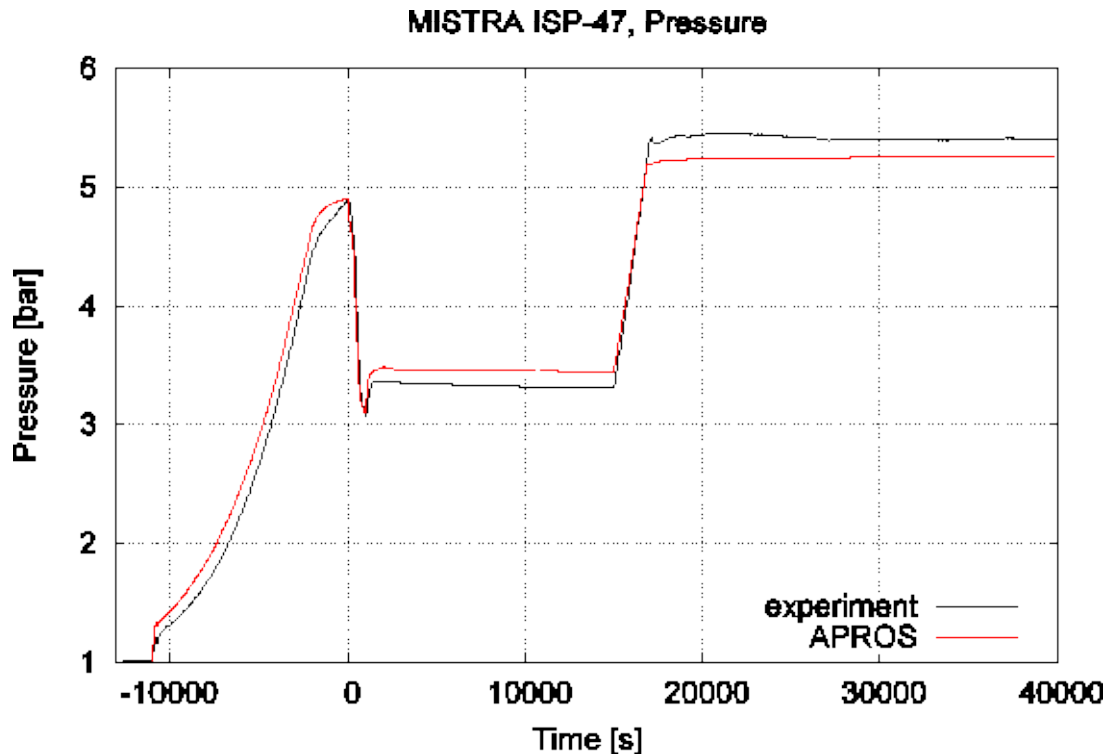

Figure 61. Comparison of APROS to experimental results of ISP-47 MISTRA experiment. Preheating phase lasts up to 0s, 0–1000 s is a cooldown phase, 1000–15000 s is air/steam steady-state, 15000–16858 helium injection and from 16858 air/helium/steam steady-state.

Applications

The improvements to the APROS calculation model are included in the official APROS releases available to all users with appropriate APROS license. The improvements in APROS-models are documented in the APROS documentation.

Conclusions

The TIFANY projects started in 2003. The projects have concentrated on improving the nuclear power plant (NPP) modeling capabilities of the APROS simulation software, especially in the containment calculation part. The project of 2006 will be last of the TIFANY-projects.

The project has produced many improvements to APROS: improved models and new features, improved or new process components, a number of APROS application models and the models have been validated against experiments or plant based data. The improvements to the APROS simulation code are available to all users with appropriate APROS license.

References

- [1] Salminen, K. APROS modelling of containment pressure suppression systems (TIFANY). Included in document: SAFIR – The Finnish Research Programme on Nuclear Power Plant Safety 2003–2006, Interim Report. VTT Research Notes 2272, Espoo 2004. 280 p. + app. 59 p. ISBN 951-38-6515-0; 951-38-6516-9. <http://www.vtt.fi/inf/pdf/tiedotteet/2004/T2272.pdf>.
- [2] Silde, A. Extension of internal spray modelling, and a new water film tracking model in containment model of APROS 5.06. Research Report PRO1/1105/05, VTT Processes, 31.1.2005.
- [3] Hänninen, M. & Junninen, P. Improvements for condensation and gas convective heat transfer in six equation model of APROS. Research Report VTT-R-00890-06, VTT Processes, 16.2.2006.
- [4] Hänninen, M. Improvement of mass and heat transfer calculation in APROS containment model. Research Report PRO1/1047/05, VTT Processes, 23.08.2005.
- [5] Harti, M. Modelling of temperature stratification with APROS in low flow conditions in large water pool. Report TERMO-499, Fortum Nuclear Services, 23 January 2006.
- [6] Hänninen, M. & Junninen, P. Steam separator model of APROS. Research Report PRO1/1103/05, VTT Processes, 28.12.2005.
- [7] Poikolainen, J. & Silde, A. Validation of the containment water pool stratification model of APROS against the POOLEX experiments STB-20 and STB-21. Research Report PRO1/P1020/06, VTT Processes, 22.9.2005.
- [8] Harti, M. Validation of the APROS 5.06 containment internal spray system model against International Standard Problem No. 35. Report TERMO-497, Fortum Nuclear Services, 7 December 2005.
- [9] Ylijoki, J. Valves of the containment model of APROS. Research Report PRO1/1040/05, VTT Processes, 18.8.2005.
- [10] Laine J. & Puustinen, M. Thermal stratification experiments with the condensation pool test rig. Research Report Poolex 1/2005, Lappeenranta University of Technology, 23.11.2005.

10. Thermal hydraulic analysis of nuclear reactors (THEA)

10.1 THEA summary report

Ismo Karppinen
VTT

Abstract

The thermal hydraulic system analysis code APROS was validated by calculating PATEL NCg, PKL and ROSA experiments. The code capability to simulate conditions where non-condensable gas reduces heat transfer was enhanced. A second order space discretization method was implemented in APROS to better track sharp concentration fronts, like a slug of water with low boron concentration.

The 3D porous media code PORFLO was improved so that large problems can be calculated. The wall condensation model implemented in the Fluent CFD code was tested by simulating the initial phase of the ISP-47 in the MISTRA test facility.

Introduction

To operate a nuclear power plant safely, it is essential to understand the thermal hydraulics and to be able to predict the plant behaviour during different transients. In predicting the plant behaviour, numerical simulation of thermal hydraulics plays a key role. The plant scale analyses are performed mainly with one-dimensional thermal hydraulic codes, e.g. APROS or RELAP. Such codes are indispensable in safety analyses, since they are the only way to predict the response of a large thermal hydraulic system, like reactor circuit. However, in many cases it would be necessary to be able to model the two- or three-dimensional features of the flow, which is often two-phase flow of water and steam.

CFD codes can capture the multidimensional effects, but they lack two-phase models suitable for nuclear applications. To overcome the lack of the desired models in the commercial codes, submodels can be added to the existing codes. If the exact modelling of geometrical details is not crucial, a practical approach is to use porous media model. In porous media codes, the vector fields are not solved in detail in the whole geometry, instead the effect of obstacles (such as tube bundles) is described through porosity of continuum. CFD and porous media models can be used as complementary methods; details of the flow field are solved with CFD codes, while larger entities can be analysed

with porous media models. Work towards applying both porous media and CFD approaches has been started in THEA project.

The objectives of the project were to develop calculation tools and increase understanding of thermal hydraulic phenomena. These capabilities are essential for safety related analyses of nuclear power plants and for supporting safety authorities in licensing related tasks. Good understanding and up to date and reliable calculation tools are important in analysing both the primary and secondary systems and the containment of the nuclear power plant. The project aimed also at educating new experts capable of understanding the thermal hydraulic phenomena, of using simulation tools and of programming thermal hydraulic models.

Main results

The work in THEA project was organised in four main tasks: 1) APROS validation, 2) development and validation of CFD tools, 3) follow up of international research programs and 4) participation in EU NURESIM project. The tasks are discussed in the following chapters.

APROS validation

A series of experiments have been performed in Lappeenranta University of Technology with PACTEL facility to investigate the effect of non-condensable gas on behaviour of heat transfer in horizontal tubes [1] (TOKE project, 1999). Though PACTEL is a model of VVER primary circuit, the effect of non-condensable gases is of general interest. The behaviour was different depending on whether the gas was heavier than steam (air, nitrogen) or lighter than steam (helium, hydrogen).

PACTEL experiments NCg-1 (air) and NCg-3 (helium) were simulated with APROS [2]. Figure 62 shows the effect of two injections of non-condensable gas on the temperatures in the steam generator (SG). Based on the simulation results, it became obvious that the accumulation of the lighter-than-steam and heavier-than-steam gases in the horizontal tube heat exchanger is different. APROS code assumes that steam and non-condensable gas form the homogeneous mixture, i.e. no separation takes place due to the mole weight of gases. Helium is lighter than steam, and therefore in reality it is collected to upper parts of the SG, while in the simulation too much helium was transported downwards with steam. Calculated pressure was too low. On the other hand, air is heavier than steam and tends in reality to escape downwards more than the homogeneous calculation model indicates. Consequently calculated pressure was too high.

To be able to simulate the phenomena found in PACTEL NCg-3 experiment a new simple model for separating light and heavy non-condensable gas was implemented in APROS. However, the simple model resulted in an unphysical temperature distribution. The light non-condensable gas was separated in the test case too efficiently from the gas mixture leading to increasing temperature of out flowing mixture. Therefore a more sophisticated model, which will take in account separation due condensation and mixing of gas components, is needed. During the work some corrections were made to APROS code to improve and stabilize calculations with non-condensable gases.

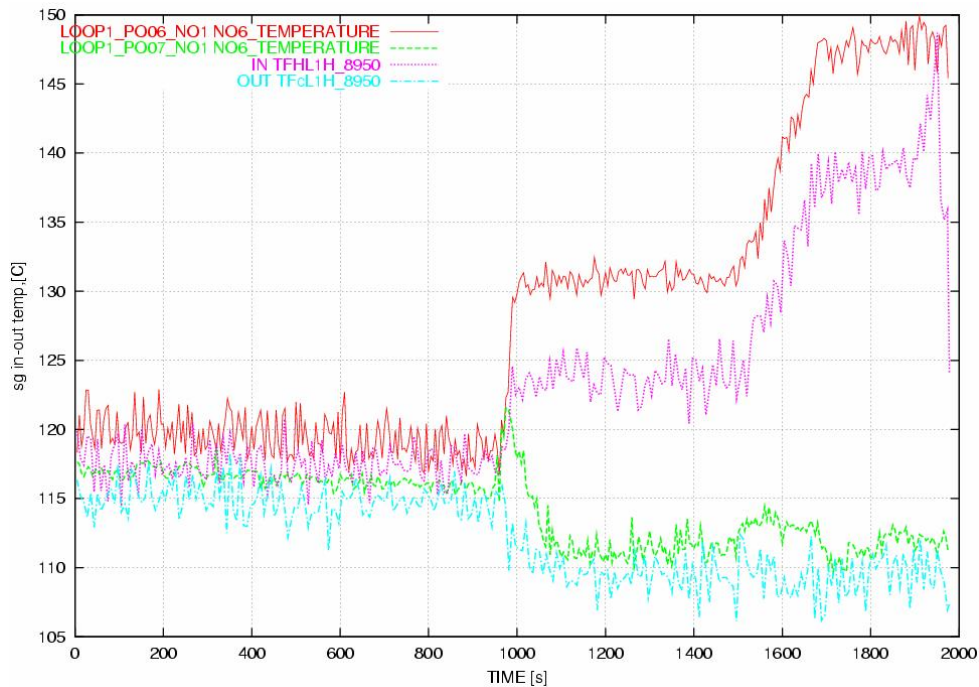

Figure 62. Calculated and measured temperatures in the steam generator inlet and outlet in PACTEL NCg-1 test.

The second order space discretization was implemented in the concentration solution of APROS. A test case of a long pipe was calculated showing improved results with reduced numerical diffusion. The new concentration solution was tested with a simple test model consisting of one pipe (length 600 m and flow area 0.01 m^2) divided into 100 calculation nodes with equal length. The mass flow in the pipe was constant (about 17 kg/s). In the beginning of the test the boron concentration inside the pipe was 1000 ppm. The boundary condition defining the incoming boron concentration was changed to 0 ppm and the simulation was continued for 500 seconds. After that the incoming concentration was changed back to 1000 ppm and the simulation continued for another 500 seconds. The test was calculated with both first and second order discretization schemas. The results of the test using the six-equation model are shown in Figure 63. When the second order discretization was used, the simulated concentration changes were much sharper [3].

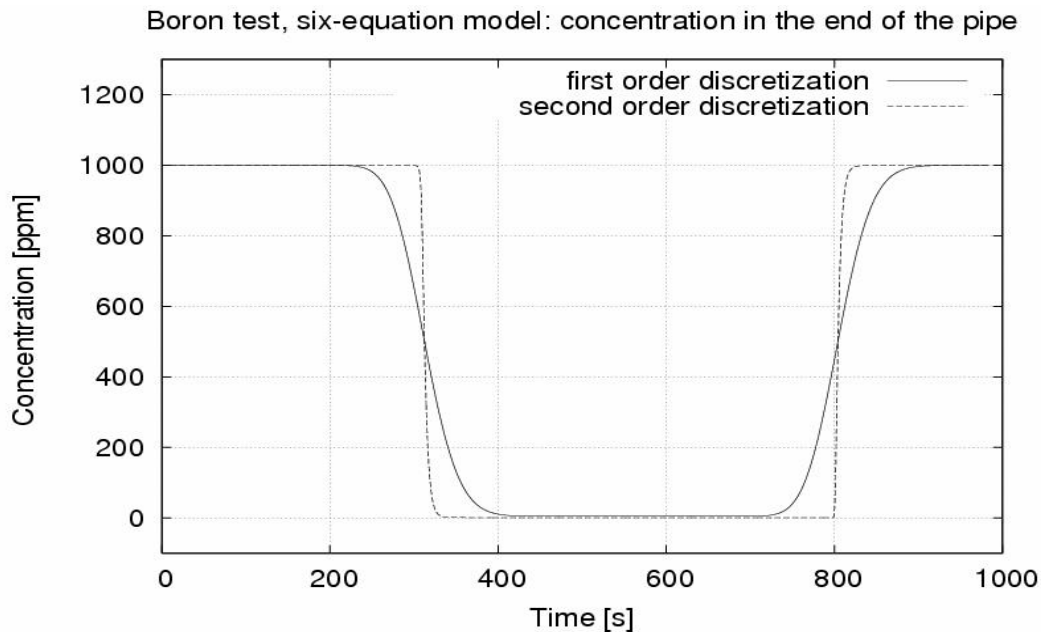

Figure 63. Boron concentration test: Concentration in the last node of the test pipe.

A calculation benchmark was organised in OECD/PKL research program, which studies boron dilution due to reflux condensation in steam generator [4]. In the benchmark the test PKL III E3.1 boron dilution during a loss of residual heat removal system at mid-loop operation was calculated with APROS [5]. Steam generator U-tubes were divided in four parallel groups in the model to better account different flow conditions and non-condensable gas concentration in the tubes (Figure 64). During the reflux boiling condensation mode the accumulation of condensed water and non-condensable gas in the U-tubes affects water spilling over the tubes and thus start up of natural circulation (Figure 65). Simulation results were satisfactory during the heat up stage, but the intermittent overflow in shortest U-tubes was not properly simulated. Therefore the calculated primary pressure rose higher than in the experiment.

Timing and amount of the overspill depends highly on the distribution of the water and the nitrogen within the primary side components. Counter current flow of steam and water in the U-tubes of the active steam generator holds liquid in the U-tubes and forms stratified condition. Two CCFL-correlations available in APROS with different values of the C parameter were tested, but interfacial friction in the calculations seemed to be too high in all cases. As a result of an excessive accumulation of water in the U-tubes, heat transfer was smaller than in the experiment and pressure stabilised at too high level. Due to the inaccurate simulation of over spilling of unborated condensate, the slug of unborated water was not properly simulated. Similar problems were found in the calculations with other codes too. The reasons for discrepancies in the calculations will be further studied in the OECD/PKL project and therefore the benchmark calculation was prolonged to January 2007.

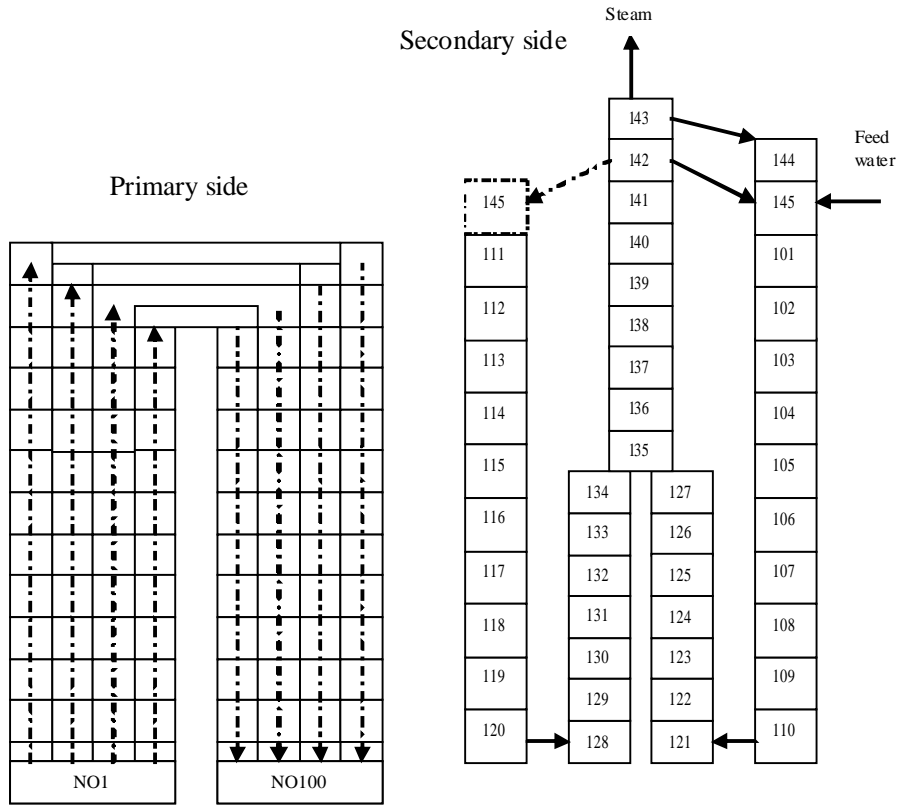

Figure 64. Nodalisation of PKL steam generator primary and secondary sides in APROS model.

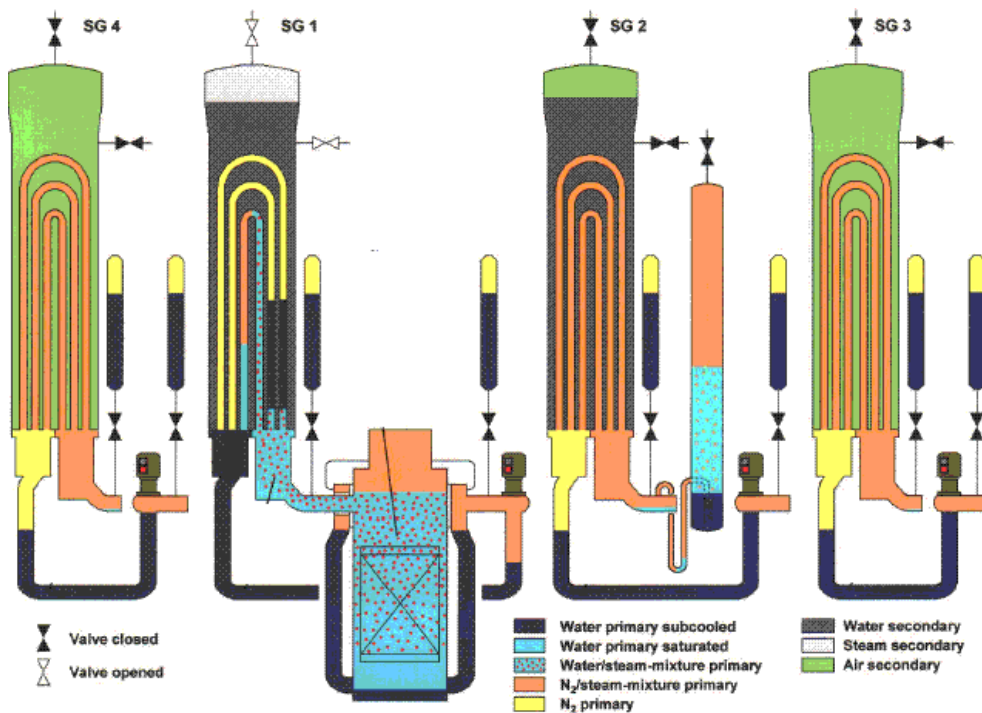

Figure 65. PKL experiment, distribution of inventory at the start of the overflow of water from the inlet to the outlet side in SG1 [6].

An APROS model for the ROSA test facility was created. ROSA is a large 1/48 scale model of a Japanese power plant, but it is in principle similar to other plants with vertical steam generator and allows therefore studies that are relevant for Olkiluoto 3 plant. The APROS model is shown in Figure 66. The first test in the OECD/ROSA research project, test 6.1, was calculated with APROS [7]. The test simulates break up of the penetration nozzle of the control rod drive mechanism forming a small 1.9 % leak in the upper plenum. Although the model needs some refinements and work is still going on, the calculated main parameters are in good agreement with measurements. Figure 67 shows measured and calculated core simulator surface maximum temperatures.

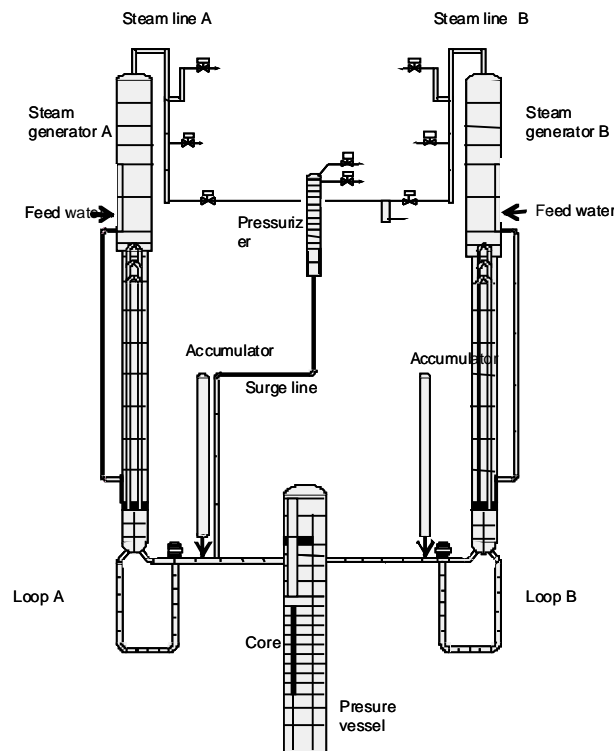

Figure 66. APROS model of ROSA test facility.

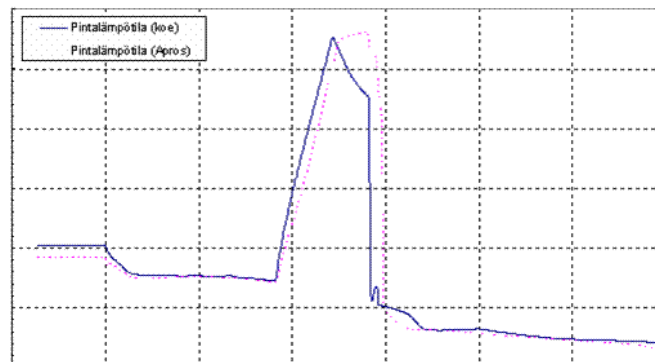

Figure 67. Measured and calculated core simulator surface temperature in ROSA experiment 6.1.

VTT participated in the OECD PSB-VVER analytical exercise. The calculations were done outside THEA project, but the results are presented here since follow up of the OECD project was included in the project. The calculations of the analytical exercise primary to secondary leak were done with APROS code version 5.05. The six-equation model of APROS was used. Both blind pre-test calculations [8] and post-test calculations [9] were done. Results show reasonable qualitative agreement with the experiment (Figure 68). There can be observed some quantitative disagreement especially in timing of the events. The main cause for timing error was behaviour of secondary pressure. Liquid and steam flow through the safety valve of the broken steam generator caused main uncertainty to the calculations.

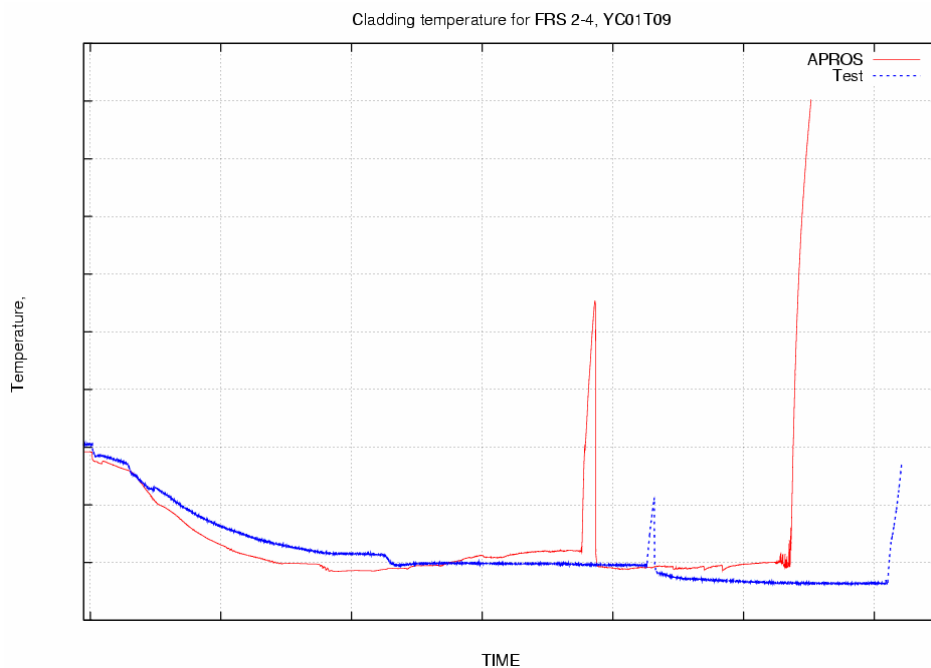

Figure 68. Calculated and measured cladding temperature in PSB-VVER PRISE experiment, post test calculations.

Development and validation of CFD tools

The 3-dimensional porous media code PORFLO has been developed at VTT. The code is based on PILEXP code, also developed at VTT, which has been used for simulating particle bed dryout experiments conducted at VTT [10,11]. The PORFLO code uses five-equation two-phase flow model. In the model, mass and energy equations are written for both liquid and vapour phases, but the momentum equation is solved only for the two-phase mixture. The phase separation is solved using drift-flux model. In the first version of the code (same solver as in PILEXP), the solution of pressure and flow distribution was based on full matrix inversion. Due to the matrix inversion time, the problem size was limited to 20 000 mesh points.

Objective of the PORFLO subtask was to realize the solution of the pressure and flow fields by using iterative algorithm belonging to the family of SIMPLE (Semi-Implicit Method for Pressure-Linked Equations) pressure corrector methods. This would enable solution of much larger problems, up to one million mesh points.

Two alternative iteration methods (ADI – Altering Direction Iteration and SIMPLE-type algorithm) have been implemented to the code. The new code versions have been tested by simulating isolation condenser pool behaviour in the experiments performed at Lappeenranta University of Technology (Figure 69). Using either of the new methods, the simulation time is linearly proportional to the mesh number. With the original iteration method (broad band matrix inversion) the solution time was proportional to the 3rd power of the mesh point number.

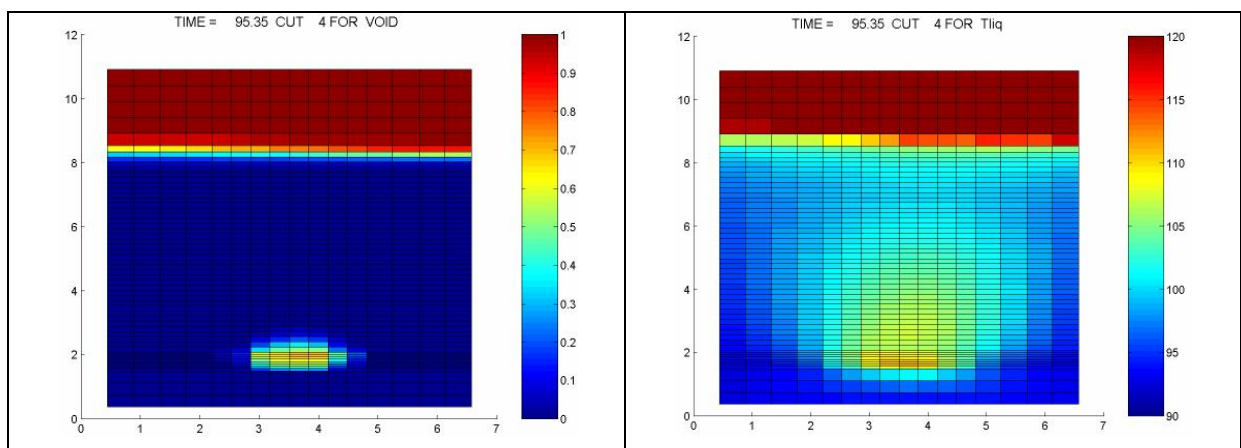

Figure 69. Void fraction (on the left) and temperature (on the right) distribution in the isolation condenser pool during initial phase of boiling calculated with PORFLO.

A condensation model implemented in Fluent CFD-code was tested with MISTRA experiment. The test modelling wall condensation in containment with presence of non-condensable gas was calculated with Fluent [12].

International research programs

Follow up of international programs listed below was included in the project.

- * OECD/NEA/CSNI/GAMA (working Group on the Analysis and Management of Accidents)
- * OECD/PSB-VVER, research program with experiments performed in Electrogorsk, Russia
- * USNRC/CAMP (Code Assessment and Maintenance Programme)
- * OECD/PKL, experimental research program with PKL test facility

- * OECD/ROSA, research program with experiment in ROSA/LSTF test facility in Japan
- * Northnet. Coordinating the Nordic network for thermal-hydraulics and nuclear safety research in Finland.

Participation in EU NURESIM project

VTT and LUT have participated in thermal hydraulic part of the EU 6th framework program NURESIM, in which a new code, NEPTUNE, for two-phase, 3D, applications for nuclear power plants will be developed. VTT has concentrated on evaluation of heat transfer and condensation models in the NEPTUNE code. The work will continue until 2008.

Applications

The enhanced and validated APROS code can be used in licensing and safety analyses of existing and new nuclear power plants. The developed 3D porous media flow solver has been further developed in the EMERALD project. The validated condensation model in Fluent can be used in containment 3D analysis.

Conclusions

APROS code has been validated by calculating PACTEL experiments, and experiments of OECD research programs. In addition to the code validation these calculations have given possibilities for young scientists to deepen their understanding of thermal hydraulics and possibilities in international co-operation.

Applications of 3D calculation in thermal hydraulics have been started in the project. Development of PORFLO code has formed a basis of further applications of the porous media model. Validation of the condensation model in Fluent has shown that detailed 3D calculations of containment are feasible and will improve understanding of stratification and condensation phenomena in the containment although further validation and model development is needed for full containment analyses.

References

1. Purhonen, H. & Puustinen, M. Integral System and Horizontal Steam Generator Behavior in Noncondensable Gas Experiments with the PACTEL Facility, Proceedings of the Fifth International Seminar on Horizontal Steam Generators, 20–22 March, 2001, Lappeenranta, Finland, Lappeenrannan teknillinen korkeakoulu, Digipaino 2001. Pp. 29–41. ISBN 951-764-582-1.

2. Poikolainen, J. Simulation of the PACTEL non-condensable gas experiments NCG-3 and NCG-1 with APROS 5.04, project report PRO1/P7035/03, 29.1.2004.
3. Ylijoki, J. Simulation of sharp concentration changes in APROS, project report PRO1/P1011/05, 25.4.2005.
4. Bugalossi, A. Validation of thermal-hydraulic codes for boron dilution transients in the context of the OECD/SETH and OECD/PKL Projects, Eurosafe, Paris, November 13–14, 2006.
5. Junninen, P. Simulating the test PKL E3.1 with APROS, project report PRO1/1029/05, 16.2.2006.
6. Umminger, K. & Schoen, B. Framatome ANP. Test PKL III E3.1: Loss of Residual Heat Removal in $\frac{3}{4}$ Loop Operation with the Reactor Coolant System Closed, Test Report. FANP TGT1/03/en/10. Erlangen, December 2003.
7. Inkinen, P. ROSA/LSTF koelaitteiston mallinnus APROS-ohjelmistolla. (To be published).
8. Poikolainen, J. Blind APROS calculations of PSB-VVER primary to secondary leak, PRO1/P1008/06, 23.3.2005.
9. Poikolainen, J. PSB-VVER primary to secondary leak post-test calculations with APROS 5.05, PRO1/P1022/06, 14.10.2005.
10. Miettinen, J. Analytical Methods for particle Bed Dryout Experiments, MOSES YE-PR-07/02, December 2002.
11. Miettinen, J., Lindholm, I., Sairanen, R. & Holmström, S. Experimental Study and Analytical Methods for Particle Bed Dryout with Heterogeneous Particles and Pressure Variation, ICONE-22420, Proceedings of ICONE 10 10th International Conference on Nuclear Engineering, April 14-18, 2002, Arlington, Virginia, USA.
12. Huhtanen, R. & Niemi, J. Simulation of condensation on MISTRA facility using Fluent code, PRO1/P1030/05, 28.2.2006.

10.2 Simulation of condensation on MISTRA facility using Fluent code

Risto Huhtanen
VTT

Abstract

Condensation of steam on wall has been simulated with CFD code Fluent which has been modified with a condensation model. The atmosphere contains air and steam in the first and additionally helium in the second case. The condensation rate compared to experimental values shows rather good agreement. The end pressure in both cases is calculated with good accuracy. The work is part of European SARnet co-operation.

Introduction

VTT is validating physical models needed for simulation together with members of SARnet (Severe accident research network), a network of excellence in European Union. Inside the working group some parties have concentrated to experimental work and others make simulations and develop physical models for nuclear safety simulations. One important item is condensation of steam to surfaces in presence of non-condensing gases.

The MISTRA coupled effect test facility was built at CEA Saclay France to cover some of the validation needs of wall condensation modelling. The facility is a thermally insulated pressure vessel with steam injection nozzles, controlled condensing surfaces, gutters for collecting the condensed fluid and instrumentation for temperature, pressure, velocity and concentration measurements. The total volume of the facility is about 100 m³. The more detailed description of the measurements can be found in [1].

Main objectives

The goal of this work is to verify the accuracy of the condensation model against experimental data. The general accuracy, grid requirements and other modelling parameters are reviewed. The general performance of the two optional turbulence models, $k-\epsilon$ and $k-\omega$, are compared in this case. Comparison to other simulations with several codes would have been useful, but VTT became a member of the group at so late stage that the coordinated comparison work was already closed.

Description of experiments

The cross section of the MISTRA facility is given in Figure 70. The given total volume is 99.5 m³. Internal diameter of the cylindrical part is 4.25 m and maximum height 7.38 m. Three annular condensing surfaces are located inside the vessel. The dimensions are shown in Table 12. The condenser surface towards the vessel axis is cooled with circulating liquid and the water condensed on the surfaces is collected and measured. The surface towards the vessel wall is insulated with synthetic foam. The thickness of the vessel wall is 15 mm in the cylindrical part and 25 mm in the lower end. The average thickness of the top plate is 119 mm. The vessel is insulated with 200 mm of rock wool. The total weight of the pressure vessel is about 40 tons.

Table 12. General dimensions of the condensing surfaces [1].

Surface	Height [m]	Area [m ²]
Upper condenser	1.784	21.4
Medium condenser	1.784	21.4
Lower condenser	2.187	26.2

The MISTRA facility includes injection nozzles for steam and helium. In the experiments documented in reference [1] the nozzle is located on the central axis of the vessel, but it can be moved to other positions as well. Here the top of the nozzle is located on the level of the lowest condenser on 1.285 m from the bottom. The circular opening of the nozzle is 0.2 m in diameter.

In the beginning of the experiments the vessel is filled with air at normal pressure and temperature. During the experiments the closed vessel is first heated up by injecting steam to the pressure vessel. The energy released in condensation heats up the structures during transient of about three hours. After the facility has gained even temperature distribution, the cooling system of the condensing surfaces is activated. Steam injection with a constant temperature and mass flux is started and the inflow parameters are kept constant until temperature and pressure in the vessel have gained a steady state. This may take about 3 hours. This transient has been recorded by saving temperature, pressure and condensation flux information during the experiment. In this simulation the transient phase is not followed but we try to calculate only the final steady state solution.

The experiments have been performed in year 2002 and repeated in 2004. In the first series there were some leaks in the steam injection line in the middle of the vessel so that the jet was not controlled as intended. The modifications were made for the later series. In the first report describing simulation by VTT [2] the reference data is from experimental set from year 2002.

Computational grid and simulations

The geometry of the vessel is modelled by using hexahedral cells. In the base grid there was 53 662 computational cells. The grid was refined adaptively near the condensing surfaces, which increased the number of cells to 97 930. Only steam injection has been considered. This simulation is described in [2]. Part of the grid is shown in Figure 70.

A new grid with about 120 000 cells was made in order to gain a better accuracy near the condensing surfaces. Injection with helium has been simulated using the fine grid.

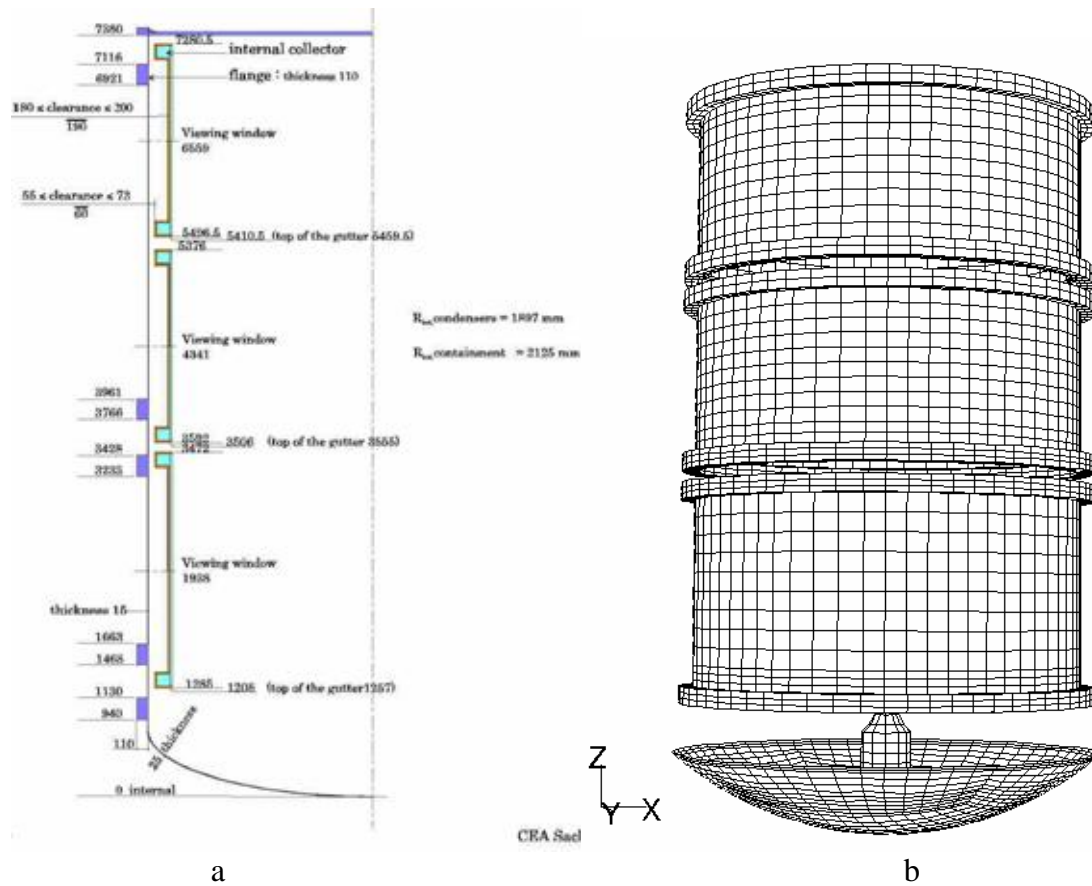

Figure 70. a) Dimensions (in millimetres) of the MISTRA facility [2]. b) Example of surface grid on the condenser belts, bottom of the vessel and injection nozzle.

Main results

The simulation was run with both $k-\epsilon$ and $k-\omega$ turbulence models. The grid of the $k-\omega$ case was refined near the condensing surfaces by dividing two cells near to the surface to smaller cells. The $k-\omega$ case was selected for refinement because problems in the turbulence field when $k-\epsilon$ model was used. Grid distortion seemed to cause “viscous” spots on boundaries of the incoming jet. The $k-\omega$ model was not so sensitive to the grid.

The transient simulation using 0.5 second time step was continued until the results showed converged steady state. During the run the original grid was refined near the condensing surfaces for better resolution. The gradient of volume fraction near the cold surfaces is very steep. The vector field and contours of velocity magnitude on plane xz are shown in Figure 71. Density and volume fraction of steam are shown in Figure 72.

Comparison of simulated condensation rates to the older experimental data set (2002) is shown in Table 13. There is not essential difference in the total condensation rate between cases using $k-\varepsilon$ and $k-\omega$ turbulence models although condensation on different condenser surfaces differs slightly. In Table 14 the same results have been calculated with the revised grid and $k-\omega$ turbulence model.

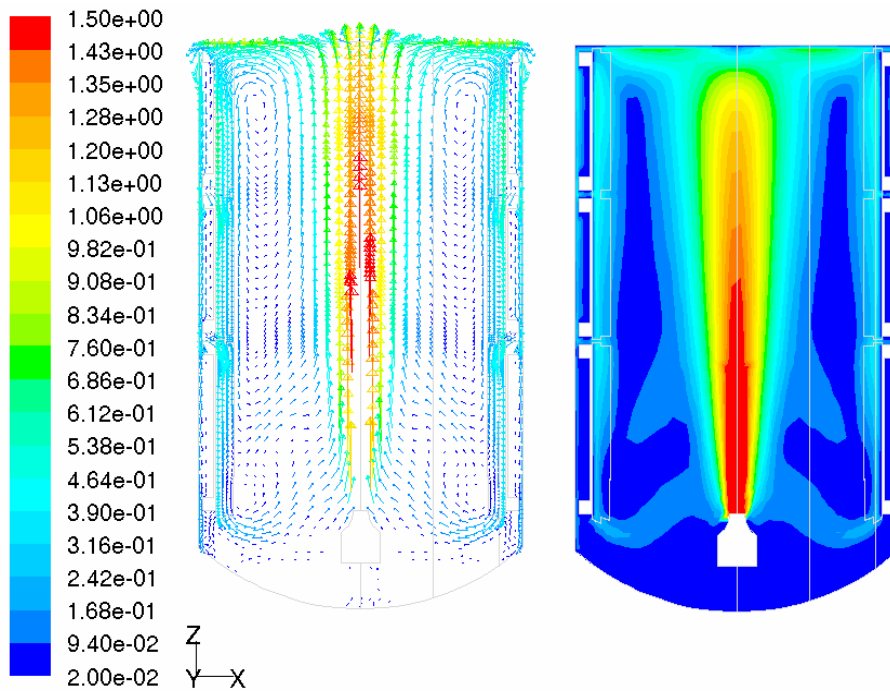

Figure 71. Velocity vector field and contour of velocity magnitude at plane xz calculated with the first grid. The range of velocity magnitude is 0...2.85 m/s. The extreme values have been omitted from the vector field but not from the contour field.

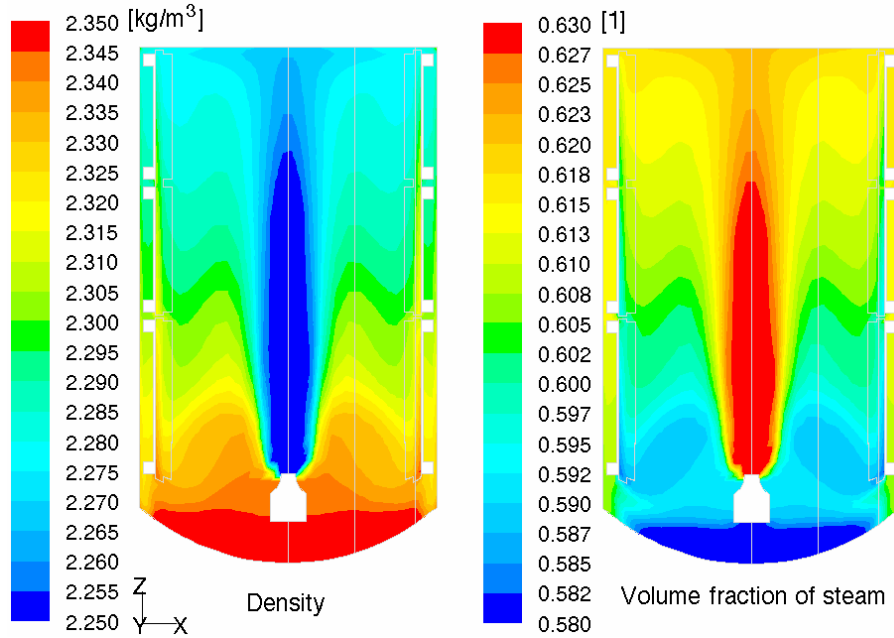

Figure 72. Density of the mixture and volume fraction of steam at plane xz calculated with the first grid. The total ranges are $1.598\dots2.446 \text{ kg/m}^3$ for density and $0.541\dots0.994$ for volume fraction.

The old and new data sets shown in Table 13 and Table 14 differ slightly from each other. The cause is obviously steam leak in the injection nozzle which delivered more steam to the lowest condenser zone.

Table 13. Condensation rates on surfaces, source mass rate to the domain and total pressure. Experimental data is from the first data set in year 2002, reference [1]. The predicted rates are essentially higher than the experimental values on the topmost condenser. See the difference to the new data set shown in Table 14.

Surface	Experimental [g/s]	$k-\omega$ model [g/s]	$k-\varepsilon$ model [g/s]
Upper condenser	40.8	53.1	60.7
Middle condenser	31.6	33.2	36.2
Lower condenser	37.5	33.0	22.4
Sum of condensers	109.9	119.2	119.3
Sum of outer walls	17.4	11.1	11.0
Total	127.3	130.3	130.3
Source flow	130.39–131.39	130.6	130.6
Pressure [bar]	3.342	3.457	3.454

Table 14. Condensation rates on surfaces, source mass rate to the domain and total pressure. Experimental data is from the revised experiments (2004) [3]. Simulation with a fine grid and $k-\omega$ turbulence model.

Surface	Exp. only steam [g/s]	$k-\omega$ model [g/s]	Exp. with helium [g/s]	$k-\omega$ model [g/s]
Upper condenser	47.8	46.5	56.6	47.9
Middle condenser	39.3	34.8	27.1	37.2
Lower condenser	28.7	34.6	29.7	28.6
Sum of condensers	115.8	115.9	113.7	113.7
Sum of outer walls	15.6	16.7	15.6	17.6
Total	131.4	132.6	129.3	131.3
Steam inflow	130.1	130.1	130.1	130.1
Pressure [bar]	3.34	3.457	5.40	5.42

Volume fraction of steam and helium according to the simulation with the fine grid is shown in Figure 73. At this final stage helium injection has been stopped and only steam is coming from the nozzle. The presence of helium alters the concentration field slightly. The condensation with helium takes place more effectively on the upper surfaces. The same can be seen in the simulations, but the change is not as large as in the experiments.

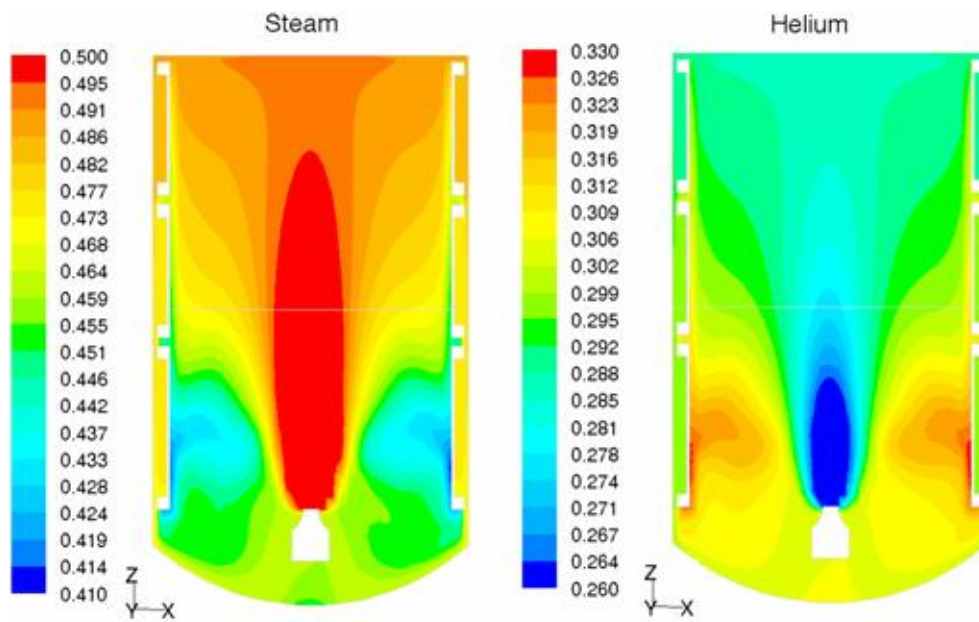

Figure 73. Volume fraction of steam and helium calculated with the fine grid.

Conclusions

The investigated wall condensation model based on wall functions works qualitatively well and reproduces the experimental results with reasonable accuracy. The results indicate that refinement of the grid near the condensing surfaces (and in general near steep gradients) improves the prediction accuracy of condensed mass flux. Also it is important to apply the relevant (mass) transport properties of the material.

The final case with grid refinement was simulated using the $k-\omega$ turbulence model, which gave better results than the basic grid with $k-\varepsilon$ turbulence model. Yet it has to be investigated to which extent the better results are due to differences in turbulence modelling and how much improvement is gained through grid refinement.

The predicted mixing-length based on two-equation turbulence modelling suggests that the proper constant value used for a mixing-length model is less than 8 cm (used in some other simulations). Especially near the surfaces the constant value has to be modified.

The predicted condensation rates show that the topmost condenser is the most efficient as indicated by the experiments.

The predicted temperature, which is higher than the experimental value, suggests that the predicted pressure will be higher than the experimental one in the case without helium. However, the difference is larger than the temperature difference implies. On the other hand the predicted volume fraction of steam is lower than the experimental value, which should diminish the predicted pressure. Clearly, between the simulation and the experiments there are differences that cannot be identified here. Pressure in the case with helium is predicted accurately.

References

1. ISP-47–Phase-A–Mistra experimental results. CEA DEN Saclay. Report DM2S. 8.4.2003. 161 p.
2. Huhtanen, R. & Niemi, J. Simulation of condensation on Mistra facility using Fluent code. Research Report PRO1/P10300/05, 28.2.2006, VTT Technical Research Centre of Finland. Espoo. 25 p.
3. Simon, H., Blumenfeld, L., Tkatschenko, I., Paillère, H., Bentäib, A. & Vendel, J. Air-steam tests in the Mistra facility: Experimental results and validation of the lumped-parameter/cfd Tonus code. The first European Review Meeting on Severe Accident Research (ERMSAR-2005). Aix-en-Provence, France, 14–16 November 2005. 14 p.

11. Archiving experiment data (KOETAR)

Vesa Riikonen
Lappeenranta University of Technology
Nuclear Safety Research Unit

Abstract

In the KOETAR project data and documents of the thermal-hydraulic experiments performed with different test facilities at Lappeenranta University of Technology were saved, checked, and archived. Some of the data and documents related to former research programs are on media that are not compatible anymore with the hardware and software in use today.

The work was done following the priority classification of the experiments updated in the SAFIR research program in 2003. The checked data and documents were archived in the STRESA database of Lappeenranta University of Technology and in CD and DVD disks.

The archived data and documents can be used in nuclear safety research to validate thermal hydraulic and computational fluid dynamics codes. The data is also suitable material for planning and understanding the future experiments and for educational purposes. It can also be used as a Finnish contribution in international co-operation projects. The data and documents in the STRESA database can be accessed easily through the Internet.

Introduction

At Lappeenranta University of Technology thermal-hydraulic experiments have been performed with different test facilities since 1975. These include, for example, PACTEL, VEERA, REWET-I, REWET-II, REWET-III and REWET-MARIA facilities. Several hundreds of experiments have been carried out. There are more than 200 PACTEL experiments alone.

Data and documents are stored on several media format from CD disks to printed papers. Some of the data and documents are even on media that are not compatible anymore with the hardware and software in use today.

Most of the results from the experiments carried out in the public research programs are owned by VTT. There are also experiments made to customers. The results of those experiments are owned naturally by the customer.

When the experimental activities related to nuclear safety research were transferred from VTT to Lappeenranta University of Technology in the beginning of 2001 the responsibility of managing and archiving the results of the former experiments was assigned for the founded Nuclear Safety Research Unit. However, funding for the research unit from the university to perform this task was not available. To solve the problem, funding (about 40–60 k€/year) was sought from the public research programs.

The archiving work began in the FINNUS research program and continued in the SAFIR research program in 2003–2006. Most of the tools and methods for the work were created during the FINNUS research program. The results and the tools of the EU CERTA project [1] (2000–2002) were also used in the work.

Main results

The main objective of the project was to save, check, and archive the data and documents of the thermal-hydraulic experiments performed at Lappeenranta University of Technology. In the first stage of the archiving project, the existing PACTEL data, originally saved on DAT tapes in binary format, were converted into ASCII format and stored temporarily in CD disks to wait further processing. This was done first because the workstation used for the data acquisition during the experiments (and needed for the binary to ASCII conversion) was near the end of its lifetime. Data from the experiments carried out with the other facilities are on media (except the paper copies) that are not compatible anymore with the hardware and software in use today. Most of the tools and methods for the archiving work were created next.

The archiving was done following the priority classification updated in the SAFIR research program in 2003. Usability of the data was checked first. Then the available voltage data was converted to engineering units and all the measured channels were checked. Inconsistent data found in the check-up were discarded. The checked data and the documents related to the experiment were archived then in the STRESA database¹ (Figure 74, <http://www.et.lut.fi/ty/stresa>) maintained by Lappeenranta University of Technology and in CD and DVD disks.

¹ Storage of **T**hermal-**R**eactor **S**afety **A**nalysis Data (STRESA) database is developed at JRC Ispra

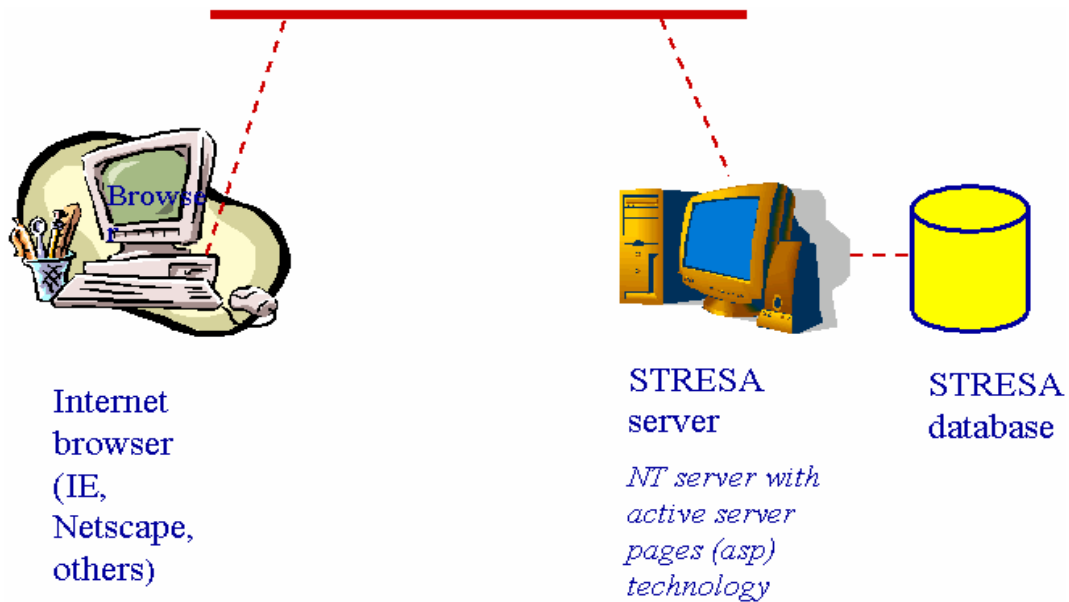

Figure 74. The arrangement of the STRESA database.

Data from the experiments carried out with the other facilities than PACTEL (REWET facilities, VEERA, and separate effect facilities) were scanned from the existing paper copies into PDF format. The results of some VEERA experiments were found also in usable digital format in floppy disks. The scanned data curves can be digitized. None of them has been digitized yet because it would have required more resources than was available in the KOETAR project.

No major problems were occurred in archiving. The time and work needed to convert; check and archive an experiment depended strongly on the amount of measurement channels in use during that particular experiment and on the similarity of the data file structure (number, position and labels of channels in the file) between the experiments in the test series. If there were no major changes from one experiment to another in the file structure, the whole test series could be archived with reasonable work after processing the first experiment of the series. With changes in the number, position and labels of the measurement channels between experiments considerably more work was needed to get the test series archived.

The spectrum of the data formats in the experiments caused a need to improve the archiving tools every now and then. Also some improvements to the plotting capabilities of the archiving tools had to be done to make it easier and faster to check hundreds of measured channels per experiment. Occasionally, difficulties were encountered in retrieving old data and documents. Especially, experiments from REWET series were problematic.

The STRESA database of Lappeenranta University of Technology (Figure 75) contains now more than 600 different experiments including the experiments archived outside the KOETAR project. By taking into account that there are more than 200 REWET-I experiments reported (as a single package) the total amount of the experiments in the database is almost 900.

The material in the STRESA database of Lappeenranta University of Technology is arranged according to the test facilities. The facility descriptions (general information) can be accessed free but the rest of the material requires a registration to the database.

The screenshot shows the main page of the STRESA database. The page title is "STRESA: Storage of Thermal Reactor Safety Analysis Data". The main content area features a "Table of content" with a list of facilities and their general information. The facilities are categorized into "Internal facility", "Separate effect facility", and "Code".

Facility Name	General information	Finland
FACTFI	General information	Finland
BLMFI	General information	Finland
REWET1	General information	Finland
REWET2	General information	Finland
BLMFI-WAPFI	General information	Finland
VEEFA	General information	Finland
Separate effect facility		
2-PHASE FLOW MEASUREMENT FACILITY	General information	Finland
FINDRI CORE CATCHER	General information	Finland
CONDENSATION POOL	General information	Finland
EPR CORE CATCHER	General information	Finland
FAPFI	General information	Finland
SCALING CONDENSER	General information	Finland
KEFO	General information	Finland
RENATA	General information	Finland
SUPAFI	General information	Finland
Code		
APRCS		Finland
CATWABE		Finland
GFIAPFI		Finland

The sidebar on the left contains navigation options: STRESA Index, STRESA navigation, Resources, Internal facility, Separate effect facility, Code, Home to STRESA, STRESA Statistics, STRESA Documentation, Links, Messages, and Contacts. A "Log in" button is visible at the bottom left of the sidebar.

The main content area also includes a "Welcome Into the STRESA Database of Lappeenranta University of Technology" message, a "Show The TOPICS covered by the database" link, and a "Table of content" link. A "Latest added documents (last 10 days)" section is visible on the right side of the page.

At the bottom of the page, there is a "Accesses to STRESA" counter showing 4579 and a footer with the text "Storage of Thermal Reactors Safety Analysis Data - STRESA - Lappeenranta University of Technology".

Figure 75. The main page of the STRESA database of Lappeenranta University of Technology.

Applications

The archived data and documents can be used in nuclear safety research for the validation of thermal hydraulic and computational fluid dynamics codes. The data is also suitable material for planning and understanding the future experiments and for educational purposes. It can also be used as a Finnish contribution in international co-operation projects. The data and documents in the STRESA database can be accessed

easily through the Internet after permission is granted. Requests for accessing the material can be sent to the Nuclear Safety Research Unit via the database web pages. The material of the experiments made to customers is given only with the permission from the owner of the results.

New material from a wide range of research topics is added into the database regularly as experimental work in the Nuclear Safety Research Unit at Lappeenranta University of Technology is still continuing. The archiving tools created in the KOETAR project are thus very useful also in processing and archiving data of future experiments.

Conclusions

At Lappeenranta University of Technology thermal-hydraulic experiments have been performed with different test facilities since 1975. Several hundreds of experiments covering a wide range of research topics have been carried out. There are more than 200 experiments just with the PACTEL facility. The checked experiment data and documents have been archived in the STRESA database maintained by the Nuclear Safety Research Unit at Lappeenranta University of Technology and in CD and DVD disks.

The STRESA database of Lappeenranta University of Technology contains now more than 600 different experiments including the experiments archived outside the KOETAR project. By taking into account that there are more than 200 REWET-I experiments reported (as a single package) the total amount of the experiments in the database is almost 900.

The archived data and documents can be used in nuclear safety research in many ways. For example, several thermal hydraulic and computational fluid dynamics codes can be validated against the checked experiment data in the archive. The database contains also good material for planning and understanding the future experiments and for educational purposes. The data can also be used as a Finnish contribution in international co-operation projects.

The data and documents in the STRESA database can be accessed easily through the Internet after permission is granted. Requests for accessing the material can be sent to the Nuclear Safety Research Unit via the database web pages. New material is added into the database regularly.

The archiving tools created in the KOETAR project are used in the Nuclear Safety Research Unit at Lappeenranta University of Technology also in processing and archiving the data of current and future experiments.

References

1. Addabbo, C. et al. CERTA-TN Consolidation of Integral System Test Experimental Databases for Reactor Thermal-Hydraulic Safety Analysis, Final Report, CERTA/SC/D9, December 2002.

12. Condensation pool experiments (POOLEX)

12.1 POOLEX summary report

Markku Puustinen
Lappeenranta University of Technology

Abstract

The condensation pool experiments (POOLEX) project has focused on studying phenomena occurring in large water pools when steam/gas mixture is injected into liquid. In a Boiling Water Reactor (BWR) power generation system, the wetwell pool serves as the major heat sink for condensation of steam in case of a primary system blowdown from a pipe break, or in case of a dedicated steam venting of the primary system. Several experiment series using DN80, DN100 and DN200 blowdown pipes have been carried out with a scaled down test facility designed and constructed at Lappeenranta University of Technology (LUT). The initial system pressure of the steam source before the blowdown has ranged from 0.2 MPa to 3.0 MPa and the pool water temperature from 8°C to 77°C. The data acquisition system has recorded measurements mainly with a frequency of 10 kHz. A high-speed video equipment has been used to capture the details of the condensation process at the blowdown pipe outlet. Depending on the used blowdown pipe diameter, initial pressure level of the steam source and pool water sub-cooling, both a stationary steam jet that forms a conical pattern below the pipe outlet in the pool and large steam bubbles that develop and condense at the pipe outlet have been observed. Furthermore, pressure pulses of the MPa range have been registered inside the blowdown pipe when the pool water temperature has been close to 10°C. Experiment series focusing on thermal stratification phenomenon has been used for model development of the APROS system code in SAFIR/TIFANY project. The coupling of computational fluid dynamics (CFD) and structural analysis codes in solving fluid-structure interactions in the SAFIR/INTELI project has been facilitated with the aid of load measurements during rapid condensation in the POOLEX project.

Introduction

The common feature of current BWRs is the use of large condensation pools with a venting system for the mitigation of the immediate consequences of a conceivable Large Break Loss-of-Coolant Accident (LBLOCA) such as a main steam line break. Also, in certain advanced light water reactor concepts, during emergency cooling conditions, mixtures of steam and non-condensable gas are blown into a pool of water via an open pipe. In both cases, steam/gas bubbles form at the pipe exit, start to rise and then

condense or break up to smaller bubbles. Pressure pulses generated by the collapse of steam bubbles due to rapid condensation, either at the pipe outlet or inside the pipe, may cause considerable loads or even damage when they impact upon a structure.

The phenomena taking place in the condensation pool after an internal pipe rupture in the containment have been investigated previously at LUT in the FINNUS/TOKE project, where the effect of non-condensable gas (air) bubbles on the performance of an ECCS strainer and pump has been studied [1]. The SAFIR/POOLEX project has focused on experiments where steam is discharged into a water pool. Lahey and Moody have presented a map of the condensation modes that can be observed during either LOCA or safety/relief valve (SRV) steam discharge [2]. Figure 76 presents some of the steam discharge experiments conducted at LUT as plotted on that map.

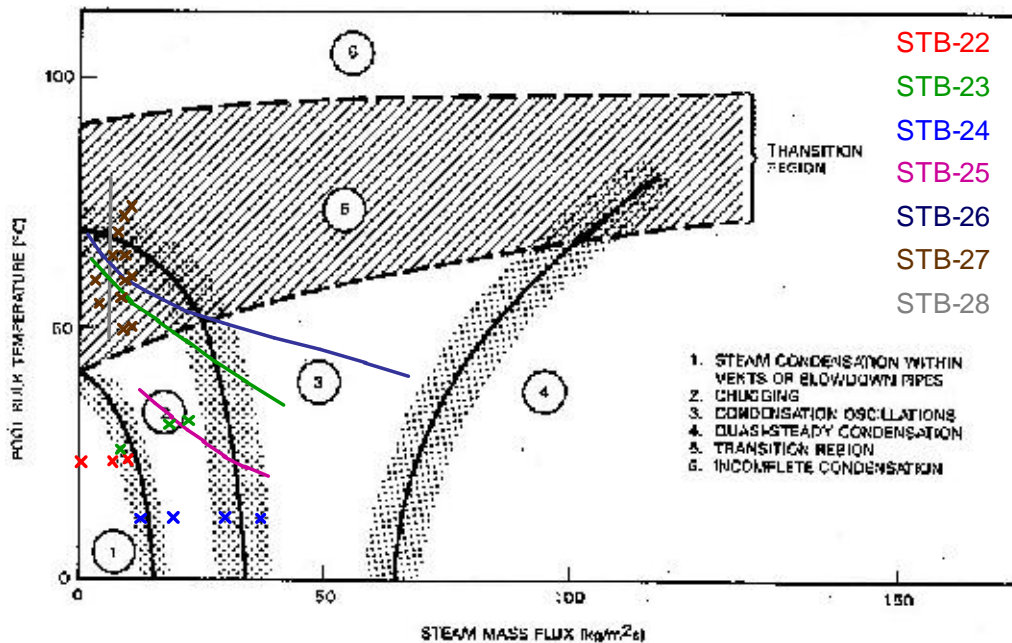

Figure 76. Condensation mode map for pure steam discharge [2]. Crosses and lines of different colours illustrate separate blowdowns during experiments STB-22, STB-23, STB-24, STB-25, STB-26, STB-27 and STB-28.

Experiment results of the POOLEX project could be used for the validation of different numerical methods for simulating steam injection through a blowdown pipe into liquid. Experimental studies on the formation, detachment, break-up and the simultaneous condensation of large steam bubbles are still sparse and thus the improvement of models for bubble dynamics is necessary for the reduction of uncertainties in predicting condensation pool behaviour during steam injection. Some of the models are applicable also outside the BWR scenarios, e.g. for the quench tank operation in the pressurizer vent line of a Pressurized Water Reactor (PWR), for the bubble condenser in a VVER-440/213 reactor system, or in case of a submerged steam generator pipe break [3].

With the aid of high-speed video captures the size and break-up heights of steam bubbles as a function of total volumetric flow-rate and of pool sub-cooling can be investigated. In determining condensation rates during bubble formation direct measurement of heat and mass transfer is desirable, but virtually impossible. However, the process of direct-contact condensation (DCC) of large steam bubbles in water is well suited for visual observation. Interfaces are macroscopic and well visible. To some extent, condensation rates can be determined indirectly from volume rates-of-change estimated from video images [4].

Pre- and post-analysis of the loads on the pool structures are necessary for the experiments. Therefore, the experiments have been modelled with CFD codes at VTT Processes. Loads calculated with CFD simulations have then been transferred to structural analysis and the stresses in the pool structures have been evaluated at VTT Industrial Systems [5, 6].

Main objectives

The main goal of the project is to increase the understanding of phenomena in the condensation pool during steam discharge. These phenomena could be connected to bubble dynamics issues such as bubble growth, upward acceleration and break up. The bubbles interact with pool water by heat transfer, steam condensation and momentum exchange via buoyancy and drag forces. Pressure oscillations due to rapid condensation and thermal stratification are also among the issues of interest. To achieve this understanding these phenomena have to be measured with sophisticated, high frequency instrumentation and/or captured on film with high-speed cameras. For example, to estimate the loads on the pool structures by condensation pressure oscillations the frequency and amplitude of the oscillations have to be known. Furthermore, strains of the pool wall at exactly defined locations have to be measured accurately for the verification of the structural analysis.

The first objective in the beginning of the project was to find out the safe operating limits of the pool facility and to define the requirements for instrumentation, data acquisition and visualization. Preliminary steam injection experiments with different blowdown pipe configurations and initial conditions were carried out [7, 8]. High frequency sensors and transducers were tested. In general, the activities associated with the preliminary tests aimed at ensuring the right approach to the detailed steam tests.

The main objective during the detailed steam discharge experiments has been the production of measurement data to be used for different verification purposes. Load estimation, structural analysis, modelling of fluid-structure interactions and thermal stratification are, for example, research areas where the data produced in the POOLEX

project can be utilized. Valuable co-operation between the thermal hydraulics, numerical simulation and structural analysis branches of the SAFIR research programme has been created and strengthened.

The final objective of the POOLEX project is a large database containing the results of the steam/air discharge experiments. It can be used for testing and developing calculation methods used for nuclear safety analysis.

Pressure loads inside the blowdown pipe and on the pool bottom

With rather low steam mass flux and cold pool water, condensation takes place within vents or blowdown pipes. A sharp drop in local steam pressure occurs as steam condenses rapidly when interacting with cold pool water. Because the condensation process is very rapid, an underpressure is developed inside the blowdown pipe. Immediately after that, a condensation-induced water hammer is initiated as the pipe begins to fill with water. At the end of the collapse, a pressure pulse occurs when the pipe is filled with water. In this condensation mode, the steam-water interface moves constantly up and down inside the blowdown pipe, see Figure 77.

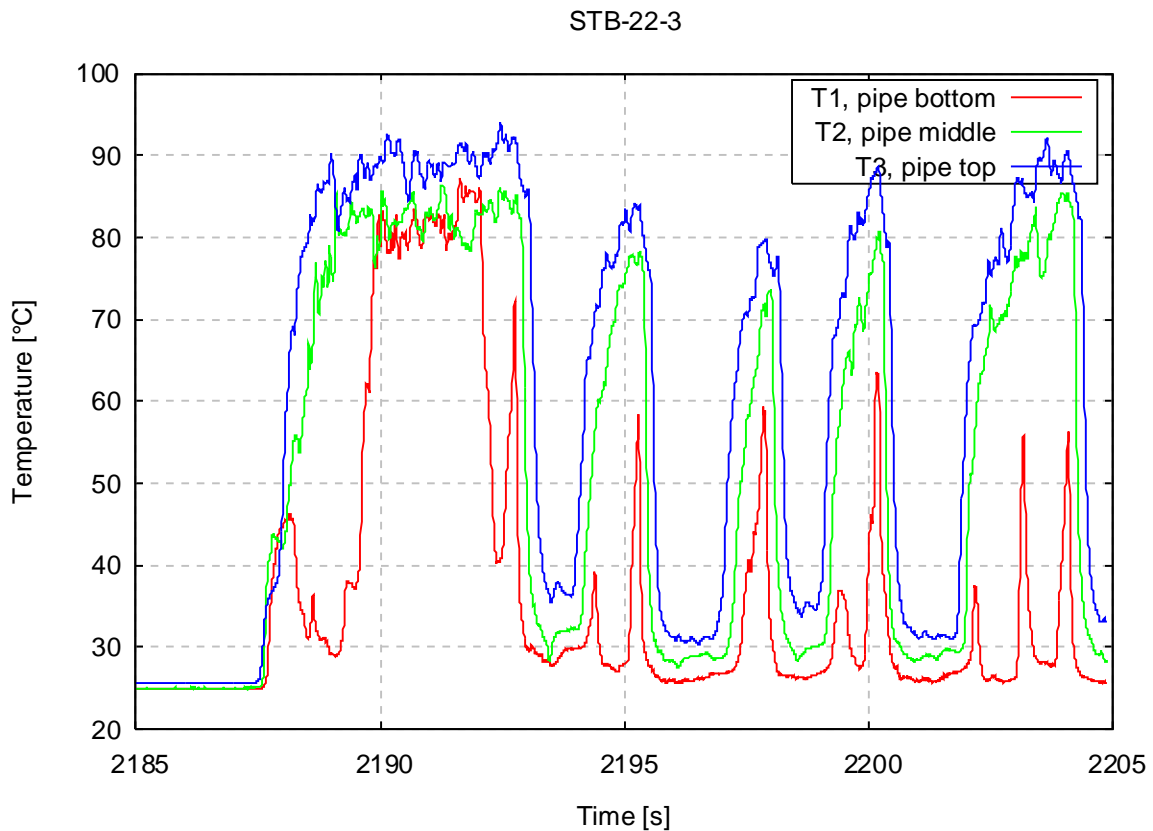

Figure 77. Measured temperatures indicate the movement of steam-water interface inside the blowdown pipe.

As the steam mass flux increases, chugging or random condensation phenomena will commence. In chugging, a steam bubble is formed at the pipe outlet. The bubble condenses rapidly and partial vacuum is generated. The steam-water interface begins to move upwards inside the pipe until the steam pressure is high enough to stop the interface and start to push it downwards again. Chugging imposes dynamic loads, not only on the blowdown pipe, but also on the submerged pool structures (Figure 78) [2, 9].

Increasing the steam mass flux further leads to condensation oscillations. In this case, steam-water interface undergoes a condensation event totally in the pool. Steam bubble forms at the pipe outlet and begins to collapse. However, the high steam flow rate prevents water re-entry into the blowdown pipe. The next bubble is formed resulting to a condensation event and the cycle is repeated. Condensation oscillations cause unsteady loads on submerged pool structures.

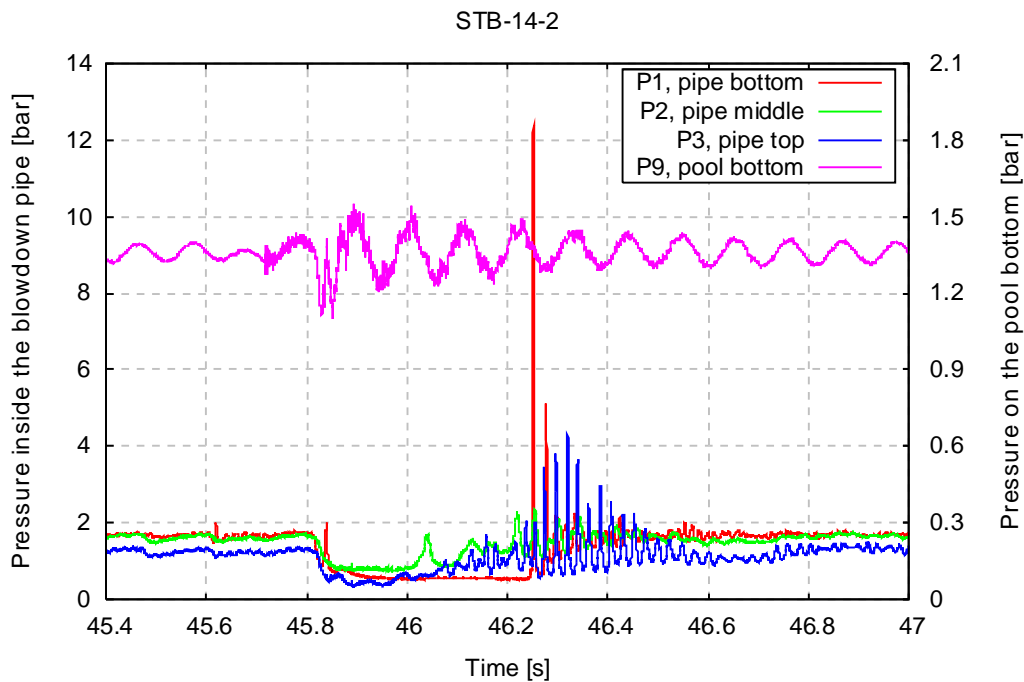

Figure 78. Measured pressures inside the blowdown pipe and on the pool bottom during chugging.

Rapid condensation of steam bubbles

Large steam bubbles form at the blowdown pipe outlet when the dominating condensation mode is chugging and the pool water is warm enough. Bubbles approximately two times the DN200 blowdown pipe diameter have been observed [9]. The collapse times of the steam bubbles (Table 15) have been estimated by viewing high-speed videos. Figure 79 shows some typical steam bubbles with different pool water temperatures when the steam mass flux is in the range of 8–10 kg/m²s.

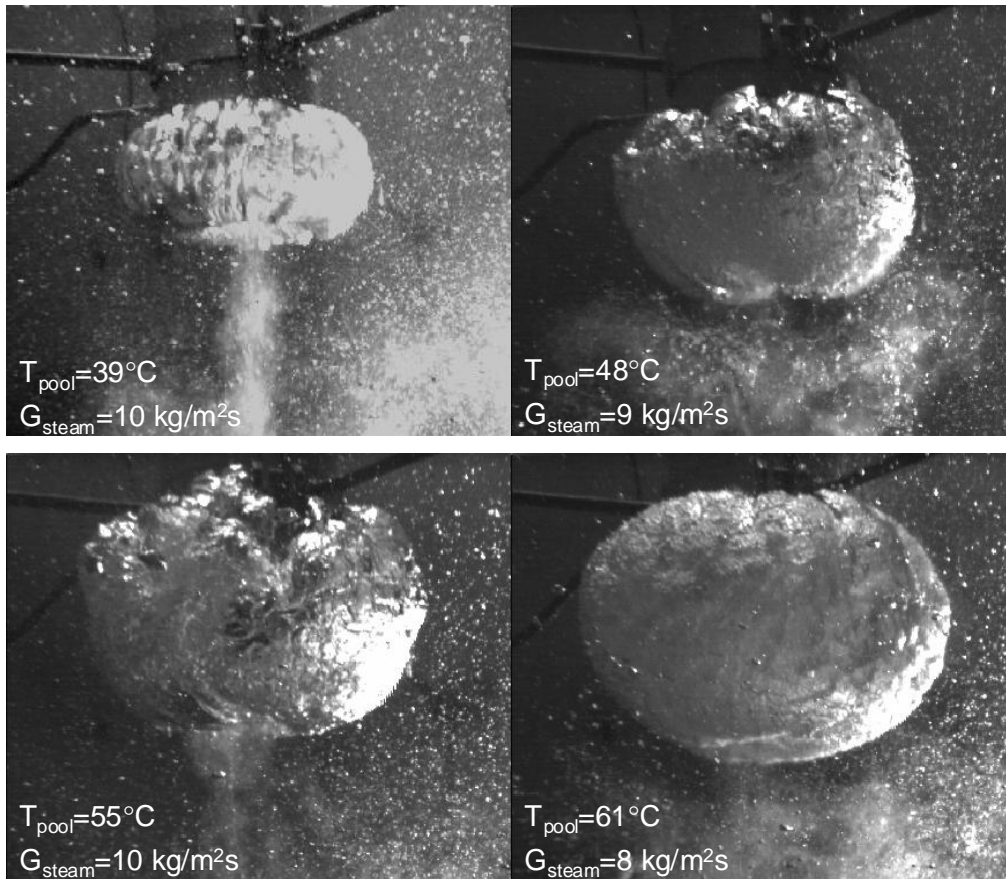

Figure 79. Frame captures from an experiment where chugging was the dominating condensation mode.

Table 15. Collapse times of the steam bubbles presented in Figure 79.

Bubble	Collapse time [ms]	Bubble diameter [mm]
Top left	20	300
Top right	50	350
Bottom left	50	400
Bottom right	60	450

Stresses due to chugging

During the steam discharge experiments loads are caused to the pool structures due to at least four different reasons: hydrostatic pressure of water, chugging, condensation oscillations and water plugs hitting to the pool bottom. Rapid condensation of large steam bubbles in the chugging region initiates condensation-induced water hammers. This causes dynamic loadings to the submerged pool structures. The maximum strain amplitude of $270 \mu\text{S}$ was measured from the bottom rounding of the pool with a steam

mass flux of $8 \text{ kg/m}^2\text{s}$ and water temperature of 77°C (Figure 80) [10]. This strain amplitude corresponds to 54 MPa of stress. When taking into account the stress caused by the static mass of water (58 MPa) the maximum stress could have been 112 MPa. The stress of this magnitude does not yet risk the integrity of the test pool.

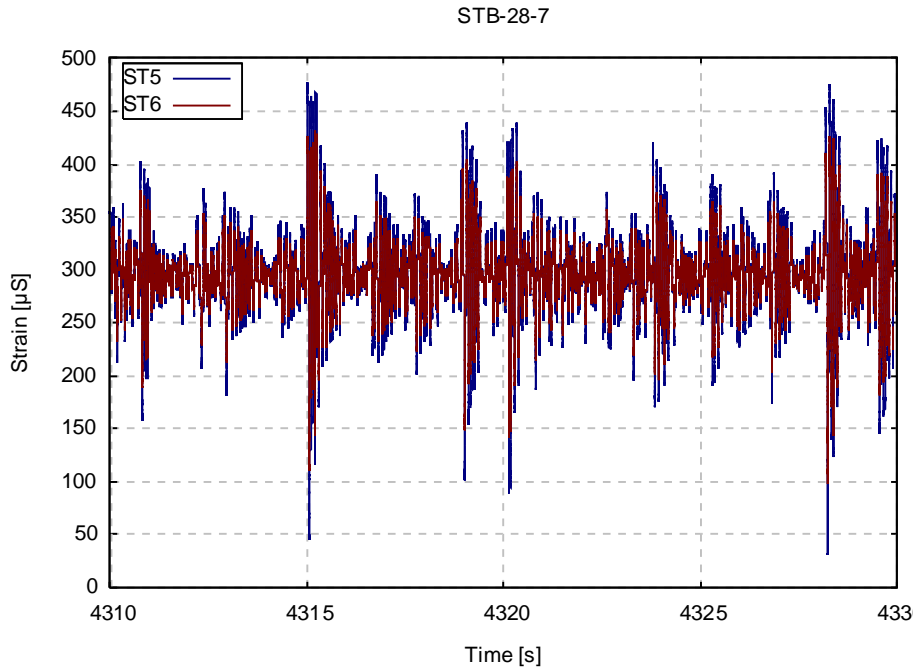

Figure 80. Measured strains due to chugging close to the rounding of the pool bottom.

Thermal stratification of condensation pool water during steam discharge

An experiment series dealing with thermal stratification of the condensation pool water in the latter phase of a postulated main steam line break inside the containment has been carried out [11]. Steam mass flow rate was scaled with the ratio of water volumes in the plant and test pool. The initial pool water temperature was about 30°C . Steam discharge was terminated when the temperature in the upper part of the pool was 67°C . After the heat-up phase, the pool was let to cool down with the measurements still on. Temperature distribution in vertical and horizontal directions in the pool was measured with 48 thermocouples installed in three vertical supporting rods, see Figure 81. Data produced in the experiments have been used for validation of the stratification model of the APROS code.

Very strong thermal stratification of the water volume above the blowdown pipe outlet level was observed after the heat-up phase (Figure 82). Temperature difference between the water surface and the blowdown pipe outlet level was about 20°C . Meanwhile, at the lower part of the pool a uniform temperature distribution (30°C) prevailed. In horizontal direction, no temperature differences were observed.

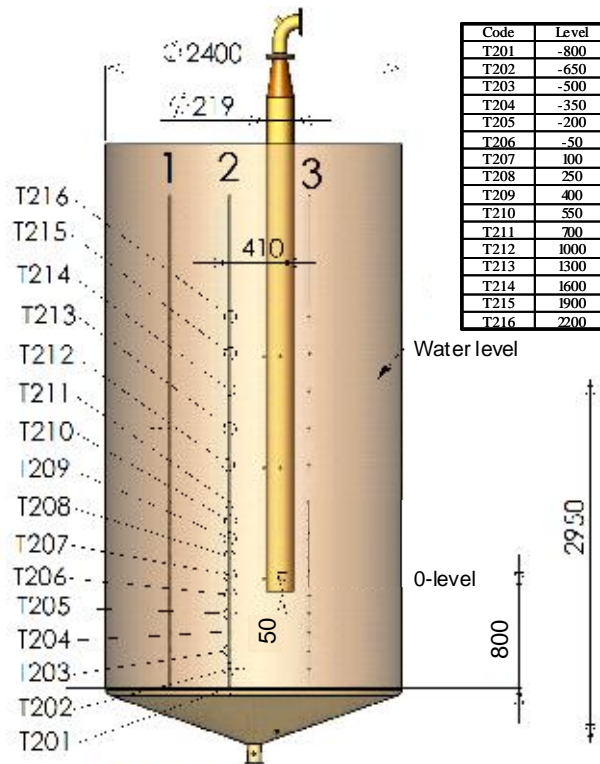

Figure 81. Instrumentation for thermal stratification experiments, thermocouples in vertical rod number 2.

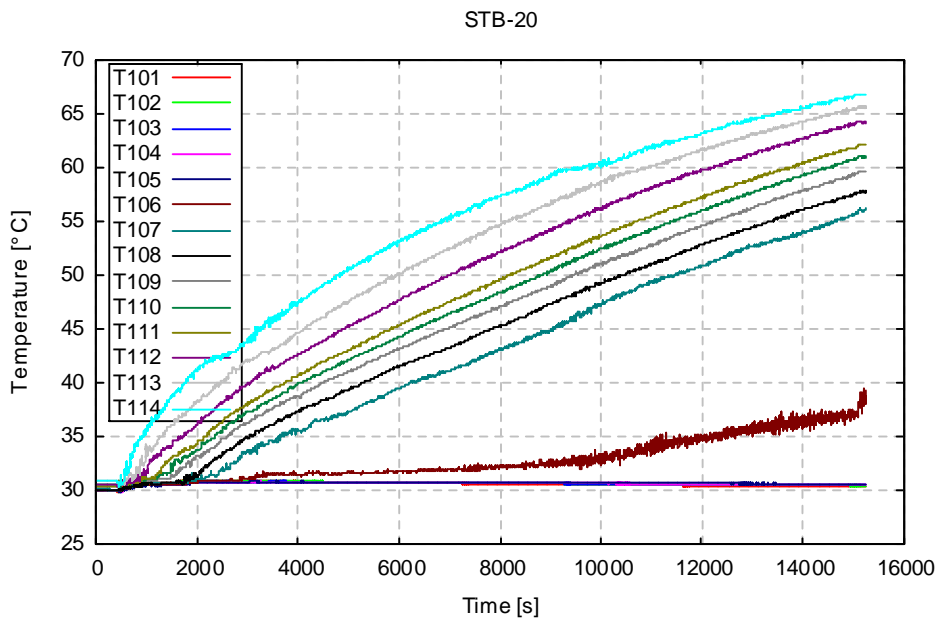

Figure 82. Development of vertical temperature distribution in the test pool during the heat-up phase of the thermal stratification experiment.

During the heat-up phase practically all steam condensed inside the blowdown pipe and the steam-water interface stayed close to the pipe outlet. No bubbles were formed at the

pipe outlet and therefore the water inventory in the pool did not mix. A falling liquid film developed on the inside surfaces of the bottom half of the blowdown pipe.

During the cooling phase stratified temperatures above the blowdown pipe outlet balanced out in about 20000 seconds. At the same time, however, the isothermal water located below the blowdown pipe outlet stratified slightly. This was a result of heat convection from the layers above.

From POOLEX to PPOOLEX

A new pool test facility including an adequate model of the upper dry well and withstanding a prototypical pressure (0.4 MPa) has been designed and constructed (Figure 83). Such a test facility will further increase the applicability of the experiment results. Possible topics to be studied on the new facility include, for example, steam discharge with several blowdown pipes, thermal mixing process of steam/water in the pool volume, level swell phenomena and the effect of pressure feedback on the system behaviour. Data on the behaviour of a scaled down containment system could be produced with the new pool test facility for the evaluation of reactor containment codes such as GOTHIC. Although the new facility replaces the POOLEX test rig, a possibility for open pool experiments still remains, since the vessel head of the new facility can be removed if necessary.

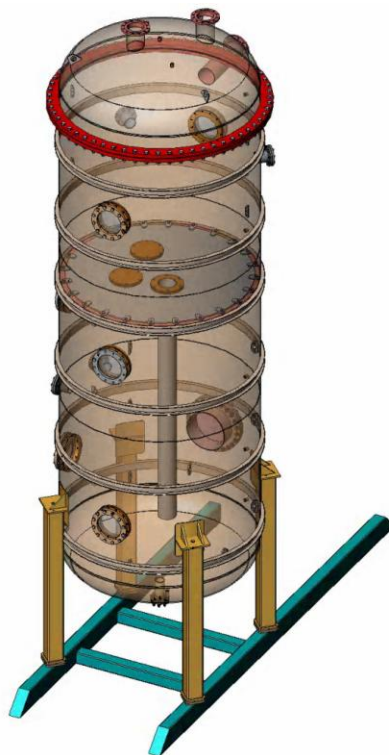

Figure 83. New PPOOLEX test facility.

Applications

The scaled down condensation pool test facility at LUT has given an opportunity to study BWR related transients of the current plant generation as well as passive safety systems of the next plant generation. Certain unanswered questions of condensation pool related safety systems in existing BWRs has been solved directly by using the information gained from the steam discharge experiments. The experiment results of the project have been of benefit to modellers in developing and validating CFD codes for nuclear safety analysis. Furthermore, the fluid/structure interactions have been studied in real conditions with sophisticated instrumentation and visualization methods. The connection of thermal hydraulics and structural loads has been built in computational environment and verified against experimental POOLEX data in the SAFIR/INTELI project by VTT. APROS models developed in the SAFIR/TIFANY project for thermal stratification resulting from a long duration blowdown into a BWR condensation pool have been validated against the POOLEX experiment results.

Conclusions

The POOLEX project has aimed at increasing the understanding of condensation pool related phenomena and at producing measurement data to be used for verification purposes of load estimation, structural analysis, fluid-structure interactions and thermal stratification. To achieve this goal several series of steam/air discharge experiments have been carried out in the pool test facility at LUT.

Preliminary experiments have shown that the frequency band and speed of standard measurement transducers and standard video cameras are not high enough to reveal the full nature of the investigated phenomena [12]. Upgrading the instrumentation and data acquisition system has thus been an absolute prerequisite for the actual experiments.

Strong pressure oscillations inside the blowdown pipe related to rapid steam condensation and water hammer phenomenon have been experienced during the DN200 experiments. When steam condenses mainly within the blowdown pipe an underpressure develops and a condensation induced water hammer is initiated. The phenomenon is pronounced in the case of cold pool water.

In the chugging condensation mode, steam flow pushes the steam-water interface downwards inside the blowdown pipe and a steam bubble forms at the pipe outlet. The bubble condenses rapidly and pressure drops below the local hydrostatic pressure. Steam-water interface moves upwards inside the blowdown pipe until steam pressure is high enough to stop the interface and push it downwards again. Chugging causes dynamic loads to the pool structures. According to strain gauge measurements, the

maximum stress amplitude at the pool bottom rounding is approximately 54 MPa. The mean stress value due to hydrostatic load of water in the tests is approximately 58 MPa. Thus, the maximum stress could have been approximately 112 MPa.

In the temperature stratification experiments the pool water has stratified strongly during the heating phase. After four hours, the temperature of water in the upper part of the pool reaches the value of 67°C. The temperature below the blowdown pipe outlet level stays at the initial value of 30°C. The pool water does not mix, since the condensation process takes place inside the blowdown pipe and therefore no steam bubbles or jet penetrate into the pool.

The coupling of CFD and structural analysis codes in solving fluid-structure interactions has been implemented in the SAFIR/INTELI project with the aid of load measurements in the POOLEX experiments during rapid condensation.

A wide range of issues related to condensation pool phenomena during steam discharge and to BWR transients have been investigated successfully during the POOLEX project. Applications dealing with CFD, structural analysis and thermal hydraulic system codes as well as with condensation pool related safety systems have been improved based on the results of the project.

References

1. Laine, J. Condensation Pool Experiments with Non-Condensable Gas. Lappeenranta University of Technology. 2002. Research Report TOKE-2/2002.
2. Lahey, R. T. & Moody, F. J. The Thermal-Hydraulics of a Boiling Water Reactor. American Nuclear Society, Illinois. 2nd edition. 1993.
3. Fischer, K. & Häfner, W. Bubble Dynamics in the BWR Wetwell Pool. *atw*, Vol. 49, No. 5, May 2004, pp. 319–322.
4. Meier, M. & Andreani, M. Yadigaroglu, G., Experimental Study of Large Steam-Air Bubbles Condensing in a Suppression Pool. Proceedings of IMECE'98. ASME. November 15–20, 1998, Anaheim, USA.
5. Timperi, A., Pättikangas, T., Calonius, K., Tuunanen, J., Poikolainen, J. & Saarenheimo, A. Numerical Analysis of a Water Pool under Loadings Caused by a Condensation Induced Water Hammer. Espoo: VTT. 2004. Research Report BTUO72-031198.

6. Timperi, A., Pättikangas, T., Niemi, J. & Ilvonen, M. Fluid-Structure Interaction Analysis of a Water Pool under Loading Caused by Steam Injection. Espoo: VTT. 2006. Research Report TUO72-056662.
7. Laine, J. & Puustinen, M. Preliminary Condensation Pool Experiments with Steam Using DN80 and DN100 Blowdown Pipes. Lappeenranta University of Technology. 2003. Research Report POOLEX 4/2003.
8. Laine, J. & Puustinen, M. Preliminary Condensation Pool Experiments with Steam Using DN200 Blowdown Pipe. Lappeenranta University of Technology. 2004. Research Report POOLEX 1/2004.
9. Laine, J. & Puustinen, M. Condensation Pool Experiments with Steam Using DN200 Blowdown Pipe. Lappeenranta University of Technology. 2005. Research Report POOLEX 4/2004.
10. Laine, J. & Puustinen, M. Steam Blowdown Experiments on Chugging. Lappeenranta University of Technology. 2006. Research Report POOLEX 2/2005.
11. Laine, J. & Puustinen, M. Thermal Stratification Experiments with the Condensation Pool Test Rig. Lappeenranta University of Technology. 2005. Research Report POOLEX 1/2005.
12. Räsänen, A. Mittausjärjestelmä lauhtumisilmiöiden tutkimukseen. Lappeenranta University of Technology. 2004. Master's Thesis. (In Finnish).

12.2 Combined effects experiments with the condensation pool test facility (POOLEX)

Markku Puustinen

Lappeenranta University of Technology

Abstract

An experimental study has been performed in the condensation pool test facility designed and constructed at Lappeenranta University of Technology (LUT) to investigate the effects of non-condensable gas on steam bubble dynamics and pressure loads during the chugging phenomenon. Steam has been mixed with air and then discharged through a submerged blowdown pipe into the test pool. The mass fraction of air among steam has ranged from 0.6 to 8.9% of the total flow. The pool water temperature has varied between 41 and 68°C.

The nature of the condensation process changes drastically, when steam mixes with air. Pressure pulses registered inside the blowdown pipe due to water hammer propagation during pure steam discharge almost disappear when the combined discharge steam and air starts. Air quantities over 2% also start to have a clear effect on the oscillations measured at the pool bottom. Both the amplitude and frequency of the pressure pulses decrease considerably.

Introduction

During a possible steam line break accident inside the containment a large amount of non-condensable (nitrogen) and condensable (steam) gas is blown from the upper drywell to the condensation pool through the blowdown pipes in the Olkiluoto type BWRs. The wetwell pool serves as the major heat sink for condensation of steam. Figure 84 shows the schematic of the Olkiluoto type BWR containment.

During the first seconds of the postulated accident the fraction of non-condensable gas among the steam/gas mixture discharging into the condensation pool is very high. After a few tens of seconds, most of the nitrogen has escaped to the wetwell pool and mainly steam flows through the blowdown pipes. Non-condensable gases have a strong effect on condensation heat transfer. The condensation heat transfer coefficient and heat transfer rate decrease with non-condensable gas. They have also an effect on pressure oscillations, related to rapid condensation, and through that on loads experienced by the condensation pool structures. Also bubble dynamics (formation at the blowdown pipe outlet, shape, detachment) are affected by the presence of non-condensable gases.

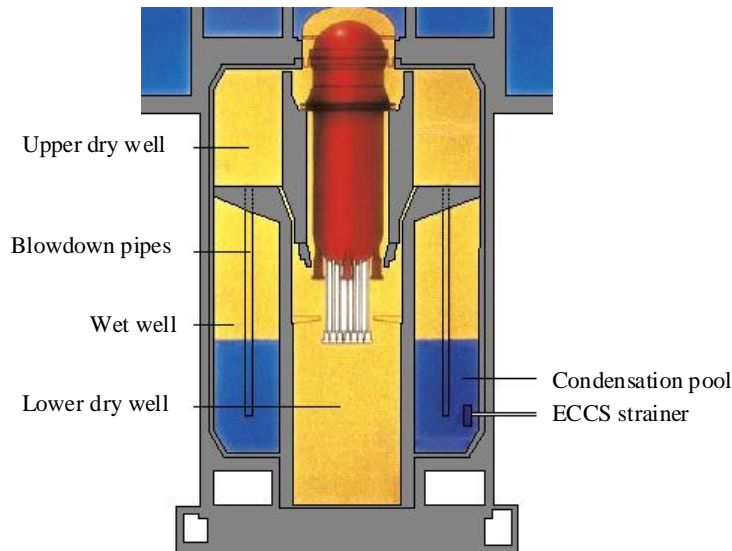

Figure 84. Schematic of the Olkiluoto type BWR containment.

In the spring of 2006, an experimental study has been performed in the POOLEX test facility to investigate the effects of non-condensable gas on bubble dynamics and pressure loads during chugging. Some results of these combined effects experiments are presented.

Condensation modes during LOCA

With low steam mass flux and cold pool water temperature, condensation takes place within vents or blowdown pipes. A sharp drop in local steam pressure occurs as steam condenses rapidly when interacting with cold pool water. Because the condensation process is very rapid, an underpressure is developed inside the blowdown pipe. Immediately after that, a condensation-induced water hammer is initiated as the pipe begins to fill with water. At the end of the collapse, a high pressure pulse occurs inside the pipe when it is filled with water. In this condensation mode, the steam-water interface moves strongly up and down inside the blowdown pipe.

As the steam mass flux increases, chugging or random condensation phenomena will commence. In chugging, the steam-water interface moves downwards inside the blowdown pipe and a steam bubble is formed at the pipe outlet, see steps 1–5 in Figure 85 [1]. The bubble condenses rapidly and an underpressure is generated (step 6). The steam-water interface begins to move upwards inside the pipe (steps 7–9) until the steam pressure is high enough to stop the interface and start to push it downwards again (step 10). Chugging imposes dynamic loads on submerged pool structures [2].

Increasing the steam mass flux further leads to condensation oscillations. In this case, the steam-water interface undergoes a condensation event completely in the pool,

outside the pipe. Steam bubble forms at the pipe outlet and begins to collapse. However, the high steam flow rate prevents water re-entry into the blowdown pipe. The next bubble is formed resulting in a condensation event and the cycle is repeated. Condensation oscillations cause unsteady loads on submerged pool structures [2].

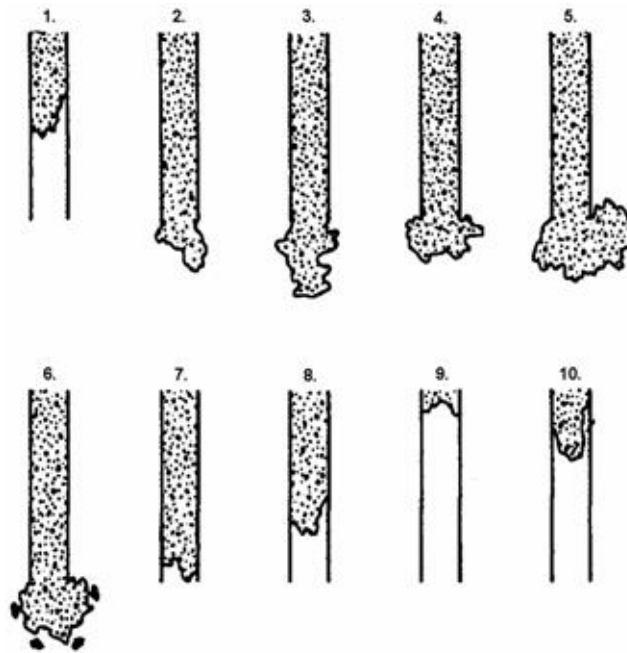

Figure 85. Sketch of the chugging phenomena [1].

With very high steam flows quasi-steady condensation is the dominating condensation mode. In this mode, high steam mass flux keeps the steam-water interface at the pipe outlet. Because steam condenses steadily, no large loads are imposed on submerged structures.

Condensation pool test facility

The condensation pool test facility is a large cylinder shaped pool with an open top and a conical bottom. The inner diameter of the pool is 2.4 m and the height 5.0 m. Steam needed during the experiments is produced with the steam generators of the nearby PACTEL facility [3]. A sketch of the test facility is presented in Figure 86.

DN200 stainless steel pipe has been used as a blowdown pipe in the combined effects experiments. The pipe is placed inside the pool in a non-axisymmetric location, i.e. 300 mm from the pool centre. Table 16 lists the main dimensions of the test facility compared with the corresponding dimensions of the Olkiluoto plant.

The test facility is equipped with thermocouples for measuring steam, air and pool water temperatures and with wide frequency band pressure transducers for observing pressure behaviour in the blowdown pipe, in the steam line and at the pool bottom. Steam and air flows are measured with vortex flow meters. Additional instrumentation includes six strain gauges on the pool outer wall close to the bottom rounding. Visual material from steam bubble formation at the blowdown pipe outlet, both with and without non-condensable gas, is recorded with a digital high-speed video camera. The data recording frequency for pressure and strain gauge measurements is 10 kHz. For temperature measurements it is 200 Hz.

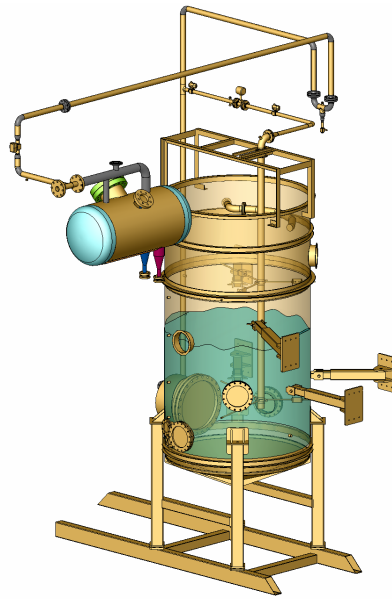

Figure 86. POOLEX test facility for steam/air discharge experiments.

Table 16. Test facility vs. Olkiluoto BWRs.

	Test rig	Olkiluoto 1 and 2
Number of the blowdown pipes	1	16
Inner diameter of the blowdown pipe [mm]	214.1	600
Pool cross-sectional area [m ²]	4.5	287.5
Water level in the pool [m]	3.5	9.5
Pipes submerged [m]	2.0	6.5
$A_{\text{pipes}}/A_{\text{pool}} \times 100\%$	0.8	1.6

Experiment programme

The combined effects experiment programme in spring 2006 consisted of three successful (and one unsuccessful) experiments (labelled from STB 32 to STB 35). Each

experiment included twelve or thirteen separate steam/gas blowdown tests. Before each experiment the pool was filled with water to the level of approximately 3.5 m i.e. the blowdown pipe outlet was submerged by 2 m. Steam flow rates ranged from 200 to 470 g/s. A period of pure steam discharge was recorded before the air injection started, see Figure 87. Air and steam mixed before reaching the blowdown pipe. The mass fraction of air among steam ranged from 0.6 to 8.9% of the total flow (Figure 88).

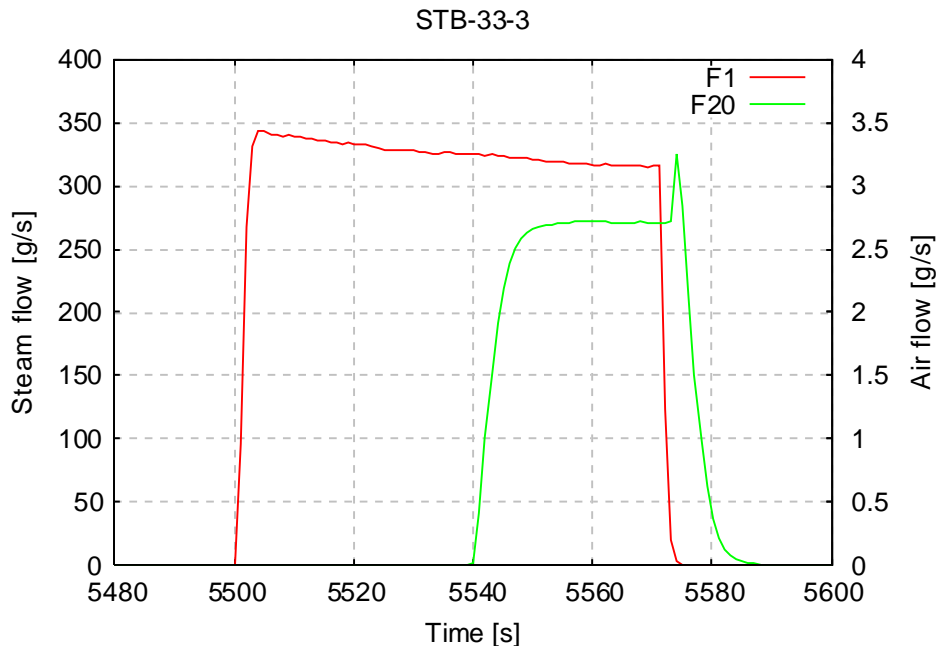

Figure 87. An example of the used procedure for steam (F1) and gas (F20) discharge in the combined effects experiments.

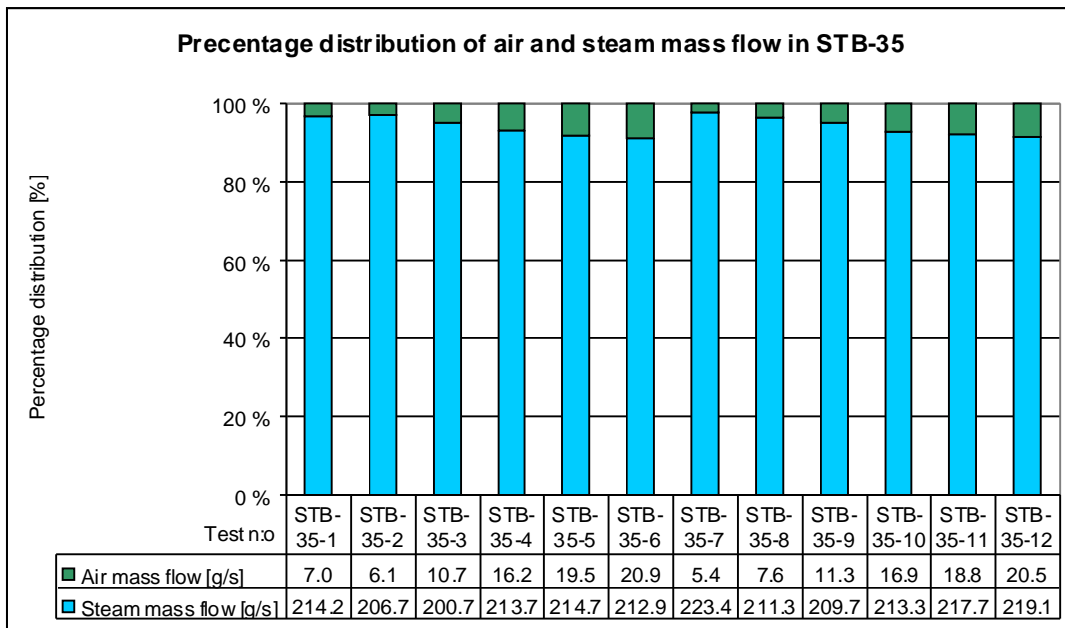

Figure 88. Percentage distribution of air and steam in separate blowdowns of STB-35.

The effect of non-condensable gas on pressure loads

The nature of the condensation process changes quite drastically, when steam mixes with air. Even quantities of less than 1% of air reduce the condensation rate considerably. Those phenomena, which are typical for the chugging region of the condensation mode map, look different after the combined discharge of steam and air starts. Pool water is no longer sucked back into the blowdown pipe as often and the upward movement of the steam-water interface inside the pipe is shorter, i.e. temperature in the middle of the pipe does not drop abruptly after the introduction of air, see Figure 89. This happens despite of the fact that the pool water is quite cold. Low pool temperature and small steam mass flux usually mean that it is not possible to avoid heavy temperature oscillations, at least not near the pipe outlet, in case of pure steam discharge. The pressure pulses registered inside the blowdown pipe due to water hammer propagation during chugging almost disappear when the combined discharge period of steam and air starts (Figure 90).

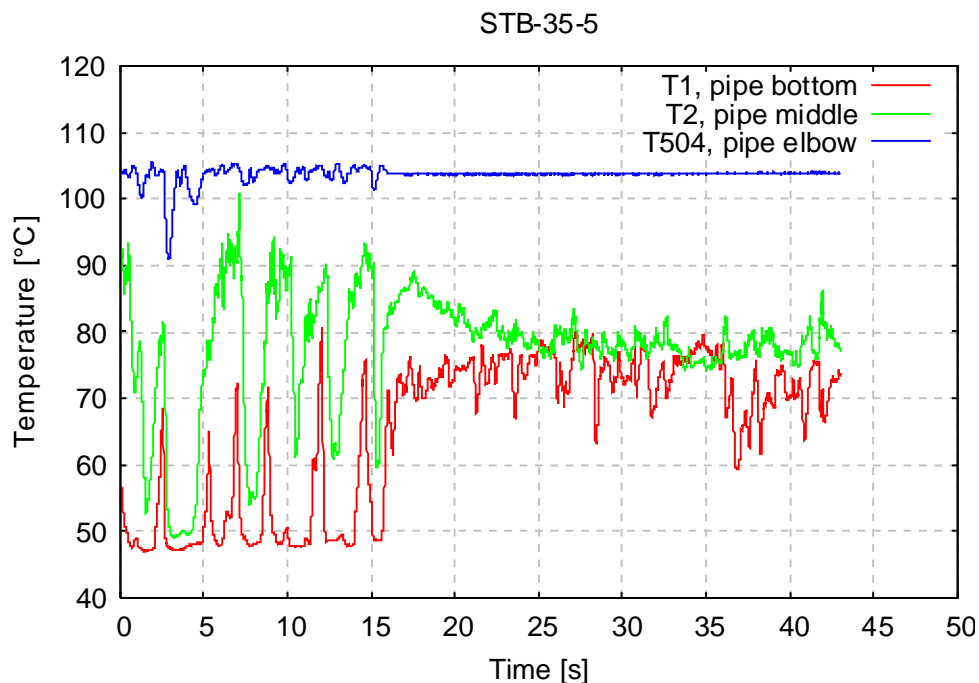

Figure 89. Temperatures inside the blowdown pipe (Air is introduced at 16 s).

Air quantities in proximity to 2% start to have a clear effect on the oscillations measured by the pressure sensor at the pool bottom. Both the amplitude and frequency of the pressure pulses decrease considerably. After the combined discharge of steam and air has started the maximum amplitude of the measured pressure signal on the pool bottom is, for example in STB-34-13, only one third of that with the pure steam discharge (see Figure 91, where the two cases are compared with the same time and pressure scales).

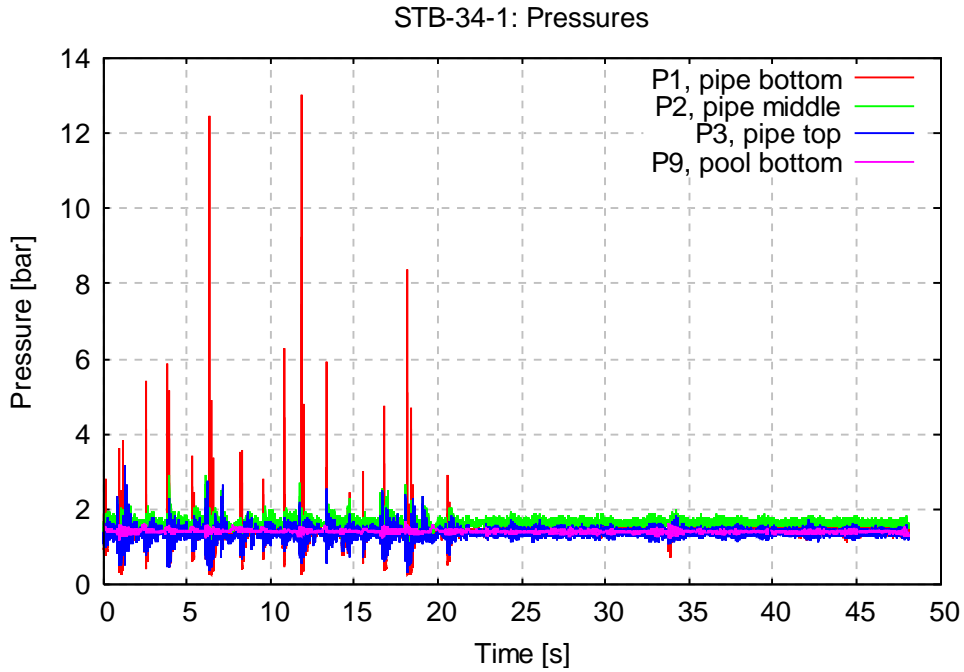

Figure 90. Pressure pulses inside the blowdown pipe (Air is introduced at 22 seconds).

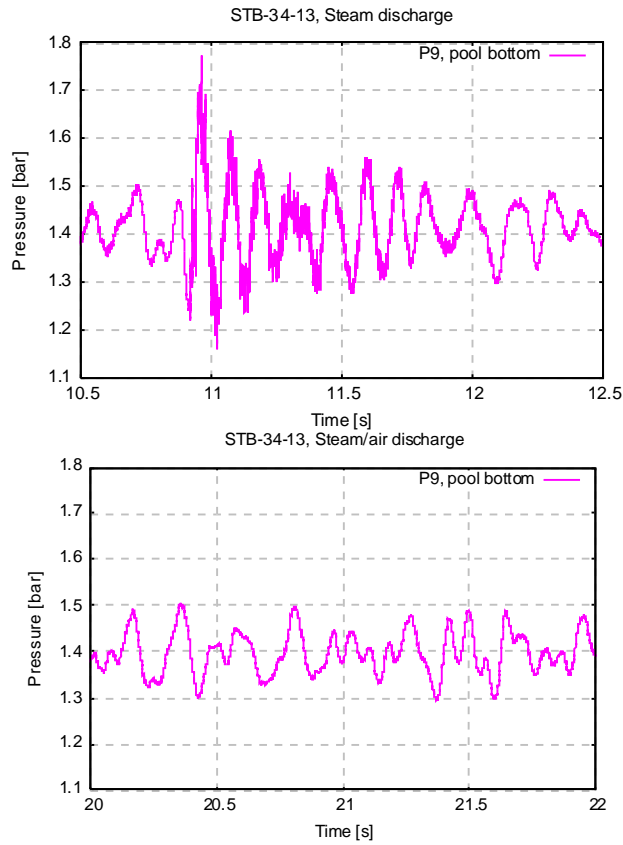

Figure 91. Pressure oscillations on the pool bottom (left with pure steam, right with mixture of steam and air).

Conclusions

An experiment series to study the effects of non-condensable gas among steam flow in the chugging region of the condensation mode map has been carried out with the POOLEX test facility at LUT. The experiments have shown that even concentrations of less than 1% of non-condensable gas among steam have a clear diminishing effect on structural loads.

The nature of the condensation phenomenon changes, when steam is mixed with air. As soon as the gas injection is initiated, water from the pool is sucked back into the blowdown pipe only occasionally. This is true even when the pool water is quite cold. Low pool water temperature and small steam mass flux normally mean that it is not possible to avoid recurrent and heavy temperature oscillations, at least not near the pipe outlet, in case of pure steam discharge.

The effect of non-condensable gas among the steam discharged into a condensation pool is very drastic from the point of view of structural loading. Practically no pressure pulses are registered inside the blowdown pipe or at the pool bottom after the combined discharge of steam and air has started. The damped oscillations associated with collapses of pure steam bubbles disappear and the measured curves indicate only smooth condensation of the steam/air mixture.

References

1. Sargis, D. A., Stuhmiller, J. H. & Wang, S. S. A Fundamental Thermalhydraulic Model to Predict Steam Chugging Phenomena. Electric Power Research Institute Report. 1978.
2. Lahey, R. T. & Moody, F. J. The Thermal-Hydraulics of a Boiling Water Reactor. American Nuclear Society, Illinois. 2nd edition. 1993.
3. Tuunanen, J., Kouhia, J., Purhonen, H., Riikonen, V., Puustinen, M., Semken, R. S., Partanen, H., Saure, I. & Pylkkö, H. General description of the PACTEL test facility. Espoo 1998. Technical Research Centre of Finland. VTT Research Notes 1929. 35 p. + app. 75 p. ISBN 951-38-5338-1; 951-38-5339-X.
<http://www.vtt.fi/inf/pdf/tiedotteet/1998/T1929.pdf>.

13. PACTEL OECD project planning (PACO)

Virpi Kouhia & Heikki Purhonen
Lappeenranta University of Technology

Abstract

The PACO project was introduced to initiate and plan a PACTEL facility related project proposal for OECD, including experimental project planning and pre-calculations. Present scheme on the proposal is to deliver it after a specialist meeting on the subject.

The experimental project planning featured a new set-up of PACTEL, Figure 92, to widen theme of research on PWR related topics. In general the studies are planned to focus on low powered situation. The planned project is expected to give more insight on involving physical phenomena as well as database for code development [1], [2] and [3].

The pre-calculations introduced simulation models of the new experimental set-up with the APROS code. First simulation tests concentrated on midloop state and the following loss of the residual heat removal system (LRHRS) transient. The simulation of the demonstrated situation turned out to be a challenging task [3].

Introduction

OECD launched the SETH project to investigate issues relevant for accident prevention and management and to ensure the existence of integral test facilities. This encouraged the idea to exploit PACTEL as an OECD project. Deriving from this prospect PACO was set to cover the demanded pre-planning period [4].

The project proposal denotes careful planning. The scientific topic of research plan has to be widely interesting and results estimated to contribute interesting information on safety issues. To emphasize the substance of the project proposal, pre-analyses have to be carried out to support the proposal [3].

Project objectives

The main objective of PACO was to produce a project proposal to OECD of the PACTEL related experiments. The task was to present a modified version of PACTEL to assist in studies of PWR related topics. The focus was set on low powered situations, and the behaviour of vertical steam generators.

To support the planning, corresponding simulation models were build and pre-calculation tests performed with one chosen transient, i.e. midloop situation followed by LRHRS failure [3].

Project results

The new set-up of PACTEL has been introduced, Figure 92. Also the pre-calculations have introduced corresponding simulation models [1], [2] and [3].

The planned OECD proposal basis and general outlines of PACTEL project are verified and conducted. In the proposal the knowledge gathered from the analytical work is utilised. The proposal includes suggestion of few predefined tests, but also a choice of one or more tests to be defined by the participants. The final proposal of the project will be finalised and delivered after a planned specialist meeting on the subject.

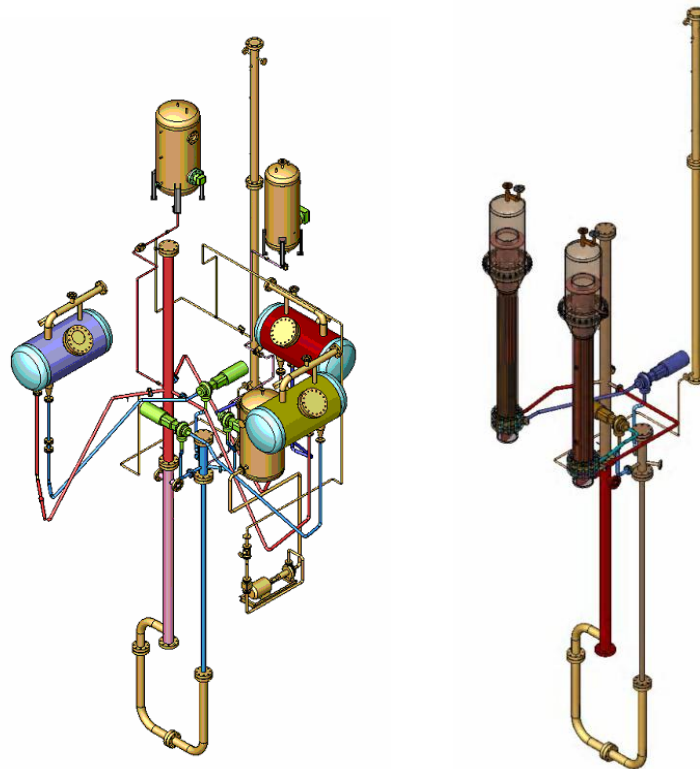

Figure 92. This figure shows the present (left) and new planned PACTEL set-up (right).

The pre-calculation tests showed possibilities and difficulties in simulation. Observation possibilities on steam generator behaviour with the models were promising. The code upgrades, done by the VTT code developers, became a crucial aspect during the pre-calculation process to aid finalise the simulation task. Apparently the particular status, including non-condensable gases and low pressure, of the transient was problematic [3].

The time frame set originally for PACO was not enough to establish reasonable pre-calculation results. The changing situation on the OECD project application prospects also delayed the completing of PACO. Finally PACO was concluded at the end of the year 2004 [3]. Since that the deliverance of the final proposal paper has been delayed wittingly because of the changing situations in OECD project prospects.

Conclusions

PACO was launched to prepare a proposal to OECD on PACTEL related research program. The supporting pre-calculations were made with APROS. A new set-up of PACTEL has been introduced as well as corresponding simulation models. The upgrades to APROS by VTT developers have improved simulation performance [3].

Recent international work in ongoing OECD projects on similar aspects of research as planned for the PACTEL project has improved the validity of this project plan [4]. The PACTEL project gives addition to the knowledge on PWR behaviour on national level.

The ultimate deliverable of an OECD PACTEL project will be finalised and delivered after a planned specialist meeting on the subject. Since the end of PACO the deliberate delay on deliverance of the final paper to OECD has been consequence of the OECD project prospects.

References

1. Tuunanen, J. et. al. General description of the PACTEL test facility. Espoo: Technical Research Centre of Finland, 1998. VTT Tiedotteita – Meddelanden – Research Notes 1929, 1998. 35 p. + app. 75. ISBN 951-38-5338-1; 951-38-5339-X.
<http://www.vtt.fi/inf/pdf/tiedotteet/1998/T1929.pdf>.
2. Purhonen, H. & Miettinen, J. PACTEL – Parallel Channel Test Loop, general description for ISP-33. ISP-33 First Workshop, Lappeenranta 18–19 February 1992, Technical Research Centre of Finland, 1992.
3. Kouhia, V. PACO Project, Summary on pre-analysis 2004–2005. YTY-01/2006. (To be published in Lappeenranta university of Technology series).
4. Schoen, B. & Umminger, K. Final Report of the PKL experimental Programme within the OECD/SETH Project, FRAMATOME ANP, FANP NGTT1/04en/04, August 2004.

14. Participation in Development of European Calculation Environment (ECE)

Heikki Purhonen & Vesa Tanskanen
Lappeenranta University of Technology

Abstract

Lappeenranta University of Technology (LUT) as well as Technical Research Centre of Finland (VTT) is participating in the Nuclear Reactor Simulations (NURESIM) Integrated Project in the Sixth Framework Programme of EU. The aim of the NURESIM project is to take the initial steps towards a common European standard software platform for the next-generation nuclear reactors simulations. The specified participation of LUT and VTT focuses on the thermal hydraulic (TH) part of the project. The main products of the project are the information transfer to Finland of the European development of simulation software, and the new platform of two-phase CFD code calculations for advanced safety analysis.

The existing POOLEX test data was reviewed and one test was selected and proposed to be used in the validation of NEPTUNE CFD module in SALOME platform. However, suggested test was considered to be too complex. It was decided to carry out a tailored experiment for NURESIM, with an insulated blowdown pipe.

The NEPTUNE CFD module was installed in a Linux system at LUT. Different calculational grids have been developed and tested. Grids have been imported to NEPTUNE CFD and free post-processing tools have been used. Simulations started with 2D geometry. 3D testing of NEPTUNE is under way.

Introduction

Lappeenranta University of Technology (LUT) as well as Technical Research Centre of Finland (VTT) is participating in the Nuclear Reactor Simulations (NURESIM) Integrated Project in the Sixth Framework Programme of EU. The goal of the ECE project is to take part in the development and validation process of the new Common European Standard Software Platform for modeling of the problematic two-phase flow simulations of present and next-generation nuclear reactors. A key activity of the project is also to maintain good relations and increase contact intensity to the European nuclear research community. The participation ensures the access to use the new platform and new simulation tools. The project gives a possibility to increase educational competence and to acquire readiness to use new two-phase flow simulation tools. Also, an important aspect in the project is to maintain the domestic preparedness to the new challenges in the forefront of nuclear simulation.

The aim of the NURESIM project is to take the initial steps towards a common European standard software platform for the next-generation nuclear reactors simulations. The specified participation of LUT and VTT focus on the thermal hydraulic (TH) part of the project, which is one of the sub projects of NURESIM. The VTT part is included in the SAFIR/THEA project. The funding share from EU is limited, but it is strategically important to stay involved in NURESIM. The SAFIR funding in the ECE project would enhance the possibilities of LUT to be also involved in the calculation work and to concentrate on the preparation of the experimental data.

Main objectives

The main products of the project are the information transfer to Finland of the European development of simulation software, and the new platform of two-phase CFD code calculations for advanced safety analysis. The new calculation environment will increase the prediction capability of the simulation tools and enhance safety of current and future nuclear installations.

The development process of a new code is very extensive task especially in the area of problematic two-phase CFD simulation. During the project performance period (three years), the simulation tools will be validated on selected experiments to gain acceptance within utility and regulatory organizations. Power companies, research organizations, safety authorities and technical universities in Finland can utilize the research results.

The goal of the ECE project is to take part in the development and validation process of the new Common European Standard Software Platform for the simulations of next-generation nuclear reactors, NURESIM. The participation ensures the access to use the new platform and new simulation tools. The project gives a possibility to increase educational competence and to acquire readiness to use new two-phase flow simulation tools.

The objectives of ECE project are as follows:

- To select, evaluate and convert suitable steam blowdown experiment data from the condensation pool test series carried out in SAFIR/POOLEX project.*
- To use these selected experiment results for development and validation of new simulation tools.*

The experiment results will be investigated thoroughly to ensure the suitability, quality and accuracy of the results for validation purposes. The new simulation tools will be installed and tested to the SALOME platform for the validation purposes of the CFD modeling. SALOME is an open source platform for numerical simulation integration and supported by Linux operating system.

Experimental data for validation

The existing POOLEX test data was reviewed and one test was selected and proposed to be used in the validation of NEPTUNE CFD module in SALOME platform [1]. However, this suggested test was considered to be too complex for the present version of the software having a fast condensing steam bubble as a validation case. After reviewing again the experiment database, an experiment with a stable steam-water interface was proposed for a validation case. As the pipe simulated a normal blowdown pipe as it exists in a condensing pool, it was not insulated. The heat flux through the pipe wall was considered too high and as it was neither measured nor possible to estimate, missing this information made it difficult to use this experiment as a test case for validation.

After these problems, it was decided to carry out a tailored experiment for NURESIM in POOLEX project [2]. An insulated blowdown pipe was introduced and a test series was carried out. One test of this series has been used for validation, see Figure 93.



Figure 93. Stable steam-water interface at blowdown pipe exit in POOLEX test for NURESIM.

CFD validation

The NEPTUNE CFD module was installed in a Linux system at LUT. Availability of SALOME platform is not crucial and NEPTUNE CFD is fully functional even without. Different calculational grids have been developed and tested. Grids have been imported to NEPTUNE CFD and free post-processing tools have been used. Simulations started with 2D geometry.

Early simulations of the POOLEX test indicated very rapid condensation if Hughes-Duffey model was used for direct contact condensation (DCC) and air effects were not taken into account. In these simulations the water-steam surface was possible to keep close to the pipe exit only by using significantly higher steam velocities than used in the experiment, Figure 94.

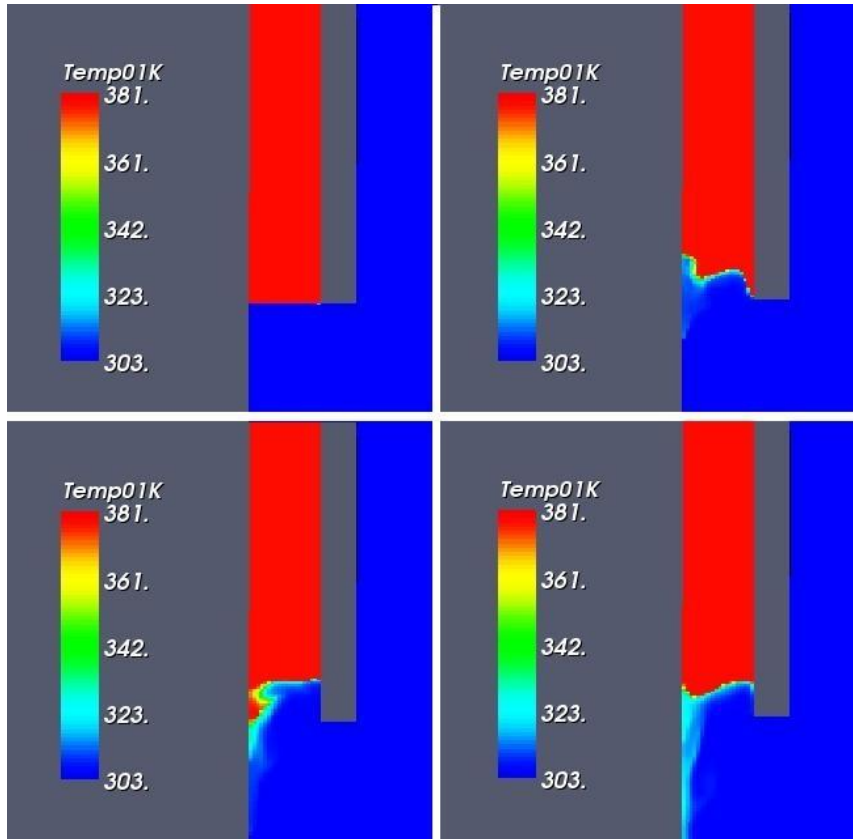

Figure 94. Simulation results of POOLEX test. Steam velocity is an order of magnitude higher than in the experiment.

Simulation in 3D geometry has started. Air as 3rd phase causes problems in simulation. In NEPTUNE air can be simulated by setting an air fraction into the steam phase, but this does not work, yet. A research visit is underway in CEA Grenoble. The duration of this visit is approximately 2 to 3 months, and during this visit, the problems of DCC modelling are discussed. Non-condensable gas, wall condensation and certain non-POOLEX DCC simulations can be discussed during this visit.

Conclusions

Lappeenranta University of Technology (LUT) as well as Technical Research Centre of Finland (VTT) is participating in the Nuclear Reactor Simulations (NURESIM) Integrated Project in the Sixth Framework Programme of EU. The aim of the

NURESIM project is to take the initial steps towards a common European standard software platform for the next-generation nuclear reactors simulations. The specified participation of LUT and VTT focuses on the thermal hydraulic (TH) part of the project. The main products of the project are the information transfer to Finland of the European development of simulation software, and the new platform of two-phase CFD code calculations for advanced safety analysis.

A tailored experiment with an insulated blowdown pipe was performed for NURESIM in POOLEX project. Achieving a stable steam-water interface was the main goal of this experiment.

Early simulations with NEPTUNE CFD in axi-symmetric 2D geometry of the POOLEX test indicated very rapid condensation if Hughes-Duffey model was used for direct contact condensation (DCC) and air effects were not taken into account. In these simulations the water-steam surface was possible to keep close to the pipe outlet only by using significantly higher steam velocities than used in the experiment. 3D testing is under way. A Research visit is underway in CEA Grenoble.

References

1. Vihavainen, J. & Puustinen, M. Review of the existing data basis for the validation of models for PTS, European Commission 6th Euratom framework programme 2005–2008, Integrated project (IP): NURESIM, Nuclear Reactor Simulations, Sub-project 2: Thermal hydraulics, Deliverable D2.1.2. (To be published).
2. Laine, J. & Puustinen, M. Condensation Pool Experiments With Steam Using Insulated DN200 Blowdown Pipe, POOLEX 3/2005, Technical Report, Nuclear Safety Research Unit, Lappeenranta University of Technology, 2006.

15. Wall response to soft impact (WARSI) & Impact loaded structures (IMPACT)

15.1 Experimental and Numerical Studies on Impacts

Kim Calonius VTT, Ilkka Hakola VTT, Simo Hostikka VTT, Ari Kankkunen TKK, Auli Lastunen VTT, Arja Saarenheimo VTT, Ari Silde VTT & Markku Tuomala TTY

Abstract

An experimental set-up has been constructed for medium scale impact tests. The main objective of this effort is to provide data for the calibration and verification of numerical models of a loading scenario where an aircraft impacts against a nuclear power plant. The experiments with fluid filled missiles yield also valuable information about the release and spreading of liquid fuel in impact. This information is vital in assessing the combustion hazard of fuel, and for analytical and numerical methods which can be applied to assess the spreading and combustion of fuel spray.

Instrumentation used in the tests includes for instance high-speed photography, force-time function measurements based on accelerometry and strain gauges, and debris tracking.

The main goal is to develop further the analytical method that defines the load-time function of relatively soft missile impacts. The second goal for further study is to develop and take in use numerical methods for predicting the response of reinforced concrete structures to impacts of deformable projectiles that may contain combustible liquid. The computational results were also needed in the continuous planning of the tests.

Introduction

The events of September 11th have emphasised the need to design protective structures for important constructions against external impact loads, caused e.g. by colliding vehicles, and to analyse carefully the possible consequences of such events, taking into account the existing experience and information.

In the open literature there are some fairly well documented test results on the subject of deformable missiles to be used as reference in developing and calibrating the finite

element simulation models and assessing the obtained numerical results. However, test results for fluid filled soft projectiles are not available in the open literature. In order to get any confidence with the simulation results, experimental, recorded data is needed for verification. The tests are carried out in IMPACT project. Numerical analyses needed for planning the tests and measurements are carried out in WARSI project. The main goal of WARSI project is to develop and calibrate finite element simulation models for reinforced concrete structures impacted by deformable missiles with fluid.

The action effects of hard missiles on structures and materials have been extensively studied in the past, as described e.g. by Johnson [1]. Further studies are needed to get an understanding of the impact forces that would arise when an aircraft impacts against a structure. An aircraft can be characterised as a soft missile due to its stiffness and mass properties. Riera (1968) [2] has proposed a method to estimate the force-time function in the case of an aircraft impact. To validate this formula, an experimental set-up has been constructed at VTT for medium-scale impact tests. The new test facility is based on a pneumatic technology that VTT has used for long time in experimental research [3]. The main part of the test system is an apparatus that is used to accelerate a missile against a vertical wall. Further details on this test system and research activity are given in the study by Kärnä et al. [4].

The main objective of this effort is to provide data for the calibration and verification of numerical models of a loading scenario where an aircraft impacts against a nuclear power plant. The experiments with fluid filled missiles yield also valuable information about the release, spreading pattern and drop size of liquid spray during an impact.

The impact force-time history of a deformable missile is determined by numerical finite element methods and by simpler analysis methods. During the impact tests, especially when using the rigid target wall, the force time history, the velocity of the missile rear end and the missile shortening during the impact were recorded for comparisons. The impact force-time function consists of the mass flow and of the crushing force of the missile. In order to verify the goodness of the numerical crushing force prediction, some static compression tests were done with the missile pipe.

Many different kinds of missiles were used in the tests. The impacts of the missiles to a rigid wall were numerically simulated with a finite element code. The analyses were demanding dynamic analyses with different kinds of non-linearities and both solid materials and fluids. Mainly axi-symmetric models were used. Especially the model mass was tried to make as close to the real one as possible. The nonlinear explicit time integration was used to solve the dynamic behaviour as a function of time. The material properties used were mainly acquired from the material tests conducted within this project.

Experimental set-up

The development of the impact test facility at VTT began in 2004. The system is built in an underground space, where a powerful pneumatic compressor was already situated. The apparatus contains a pressure accumulator, an acceleration tube and a counter reaction frame in the rear of the tube. An overview of the test facility is shown in Figure 95.

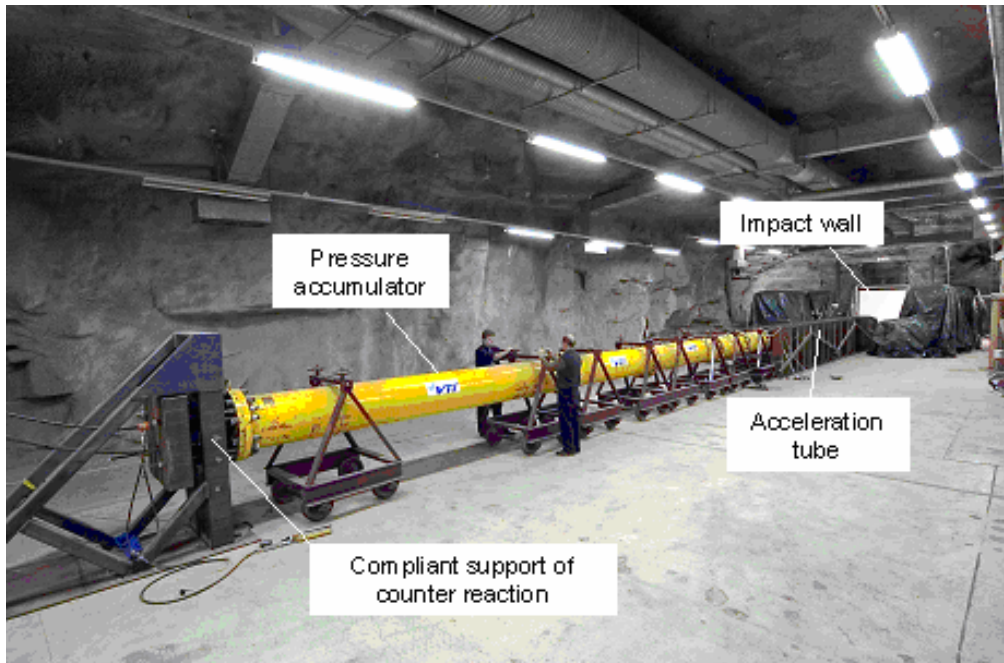

Figure 95. Overview of impact test facility.

A principle of the apparatus is based on compressed air which gives the required energy and velocity for a piston and a missile. A thin explosion steel disk installed between the pressure accumulator and the acceleration tube fractures and explodes at a calibrated pressure level and the discharged compressed air accelerates the piston. Also plastic explosion sheatings can be used for lower pressure values. Special purpose software was developed for selecting an appropriate rupture disk for each test depending on the mass and the required velocity of the missile.

In the first tests the piston itself was representing the missile and accelerated inside the acceleration tube. However, this arrangement imposes serious restrictions on the dimensions and the shape of possible missiles. Also, condensation of the air humidity due to extreme cooling during the (nearly isentropic) expansion hinders observations by high-speed photography. An original steel piston, which was used in a preliminary test, is shown deformed after collision in Figure 96. The mass and the length of the piston were about 22 kg and 1250 mm, respectively.



Figure 96. Steel piston after impact with the speed of 143 m/s.

Alternatively, the piston inside the acceleration tube can be connected to a missile that moves on a track above the acceleration tube. In that case, the piston itself is forced to collide with an inclined catcher plate. The force transmission between the piston and the missile was designed and tested to resist the inertial force, which is very high at the beginning of the acceleration. The piston in the acceleration tube pushes the missile at the top of the tube via a steel fin connected to the piston. After the acceleration, the piston is captured by the catcher plate while the missile continues its flight freely to the destination wall.

Missiles tested with the apparatus shown in Figure 95 were made of either steel pipe, thin-walled spirally seamed air-conditioning pipe or aluminum pipe. Some of the missiles were filled with water in order to observe spreading of the liquid. In addition, some missiles were filled with low strength concrete, utilizing a corrugated plastic tube as a formwork, in order to enhance the mass flow effect in the impact force of the missile. The mass of the missile varied up to 100 kg depending on the test. The impact velocity is accurately controllable between 100–200 m/s.

An example of the test series is a test with the steel pipe missile in Figure 97a. The missile was shot using rails at the top of the acceleration tube. The weight, the length and the diameter of the missile were 40 kg, 1000 mm and 273 mm, respectively. In this particular test the impact velocity of the missile was 154 m/s. The deformed missile is shown in Figure 97b.



a.



b.

Figure 97. Steel pipe missile before (on the left) and after (on the right) the test.

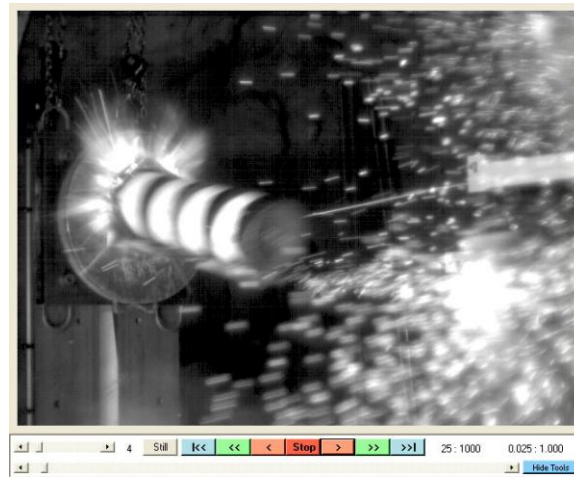
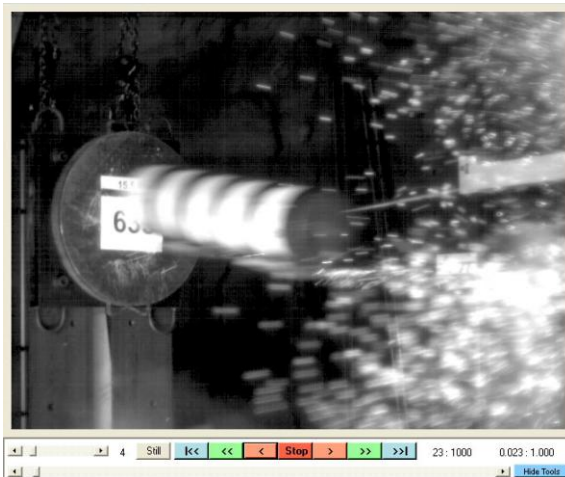

Figure 98. Still figures of steel pipe missile during an impact.

The deformation progress of this particular steel pipe missile in collision is shown in Figure 98. The still figures are from a film shot by a high speed video camera with exposure speed of 1000 frames per second. The figures give also information about the missile speed and deceleration before and during the collision. The sparks behind the missile are due to the friction between the missile and the rails. The condensation of the air humidity can also be seen a moment after the sparks.

The velocity of the missile is measured by two high speed laser devices. The deceleration of the missile is measured by a shock accelerometer. The acceleration of the concrete wall is measured by accelerometers. In addition, the pressure of the pressure pipe and the acceleration tube is measured by high speed pressure sensors. The velocity of the missile can also be calculated using pressure peak values during the explosion.

One of the main ideas in impact tests is to measure the force-time function during a collision. In this project, the force is measured by two separate measuring systems. If the main objective is to study the behaviour and the impact force of the missile crushing against a rigid target, the force is measured by a force plate, which consists of a rounded steel plate with diameter of 700 mm and three force transducers installed behind the plate. The second possibility is to use the supporting back pipes, which are fixed to the rock wall. The impact force can also be measured using strain gages glued in each one of the back pipes. When concrete walls are tested, the impact force can only be measured by the back pipes.

Recent tests were made by accelerating the missiles above the acceleration tube onto the force plate or onto reinforced concrete test slabs. The behavior of the target slab is monitored by deflection transducers and strain gauges glued on the reinforcement bars.

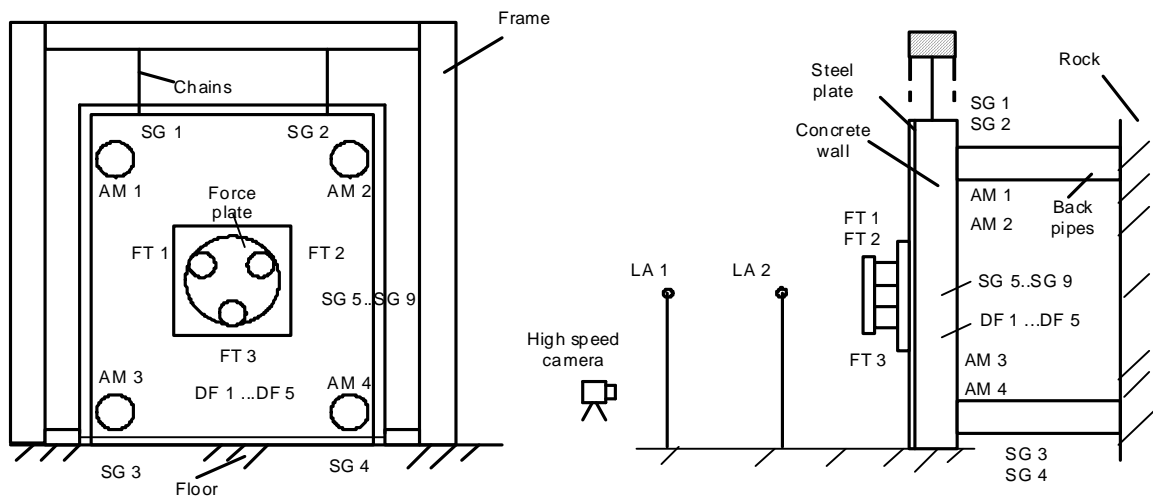

Figure 99. Instrumentation of test wall.

The high-speed photography is invaluable in monitoring the missile and wall break-up processes and debris and/or liquid dispersal. In the present configuration, the span of the concrete test slab is about 2.2 m. All the data is collected using high speed acquisition cards with the speed of 100 kilo samples per second. The sensors and test setup is depicted in Figure 99.

Numerical studies on deformable missiles

The main goal was to develop further the analytical method that defines the load-time function of relatively soft missile impacts. All the tests with different kinds of missiles have been analysed, but only a single typical example test is concentrated on in the computational part of this special report. It is a test with a cylindrical missile depicted in Figure 100. It was composed of thin walled steel ventilation pipe and of some stiffening and strengthening elements from steel. The ventilation pipe as the chosen main part of the missile structure was based on the prototype in MSc. Thesis by Eriksson [5]. The main challenge in designing the missile was that it had to withstand undamaged the extreme acceleration which may reach up to 400 g. That is why additional stiffening elements were necessary. The length and diameter of the missile were 1.5 m and 250 mm, respectively. No fluid was included. The mass of the missile was 45.4 kg and the impact velocity was 122 m/s. As can be seen from the deformed missile shape after the test (on the right in Figure 100), the ventilation pipe part of the missile was contracted and folded all the way inside the stiffening back part.



Figure 100. Spiral-weld steel pipe missile before (on the left) and after (on the right) the test.

The resultant load-time function of the impact between the relatively soft missile and a rigid wall can be analytically calculated. Riera (1968) [2] has proposed a following method to estimate it. Assuming that the mass of the crushed part of the missile moves

with the target structure an equation for the conservation of momentum for the missile/target system yields

$$F(t) = \frac{d}{dt}(M_r v_m + M_c v_t), \quad (1)$$

where F is the reaction force, M_r is the mass of the uncrushed part, M_c is the mass of the crushed part, v_m is the velocity of the missile at time t and v_t is the velocity of the target at time t . If the velocity of the target v_t can be neglected then the above formula yields

$$F(t) = P_c(x(t)) - m(x(t))(v_m(t))^2, \quad (2)$$

where P_c is the crushing load or buckling load of the missile body, $m(x(t))$ is the mass per unit length of missile (at time t in contact with the target) $v(t)$ is the velocity of the undeformed (or uncrushed) part of the missile at time t . The crushing load of the missile section is calculated as a sum of the crushing loads of the nested cylinders, thereby neglecting possible interactions between cylinders. In the calculation model the missile can be divided into segments (lengthwise) and in each segment concentric cylinders representing the different parts can be defined. For each part individual kinematic (folding mechanism or squash) and material (plastic or viscoplastic) behaviour can be defined.

Based on a tension test made for a specimen cut from the spirally seamed pipe with a wall thickness of 1.2 mm the yield stress of the pipe material is assumed in the calculations to be 350 MPa on average during the deformation. For the other steel parts of the missile the yield stress is assumed to be 260 MPa. Because steel is known to be strain rate sensitive or visco-plastic the dynamic yield stress is calculated by the Cowper-Symonds formula for uniaxial tension or compression

$$\sigma_{y,dyn} = \sigma_y \left[1 + \left(\frac{\dot{\epsilon}}{D} \right)^q \right]^{\frac{1}{q}} \quad (3)$$

where σ_y and $\sigma_{y,dyn}$ are the static yield stress and the dynamic flow stress, respectively, and D and q are material parameters. The density of steel is assumed to be 7850 kg/m³. The isotropic elastic material parameters are $E = 2.1 \cdot 10^5$ MPa and $\nu = 0.3$. A folding visco-plastic mechanism is used in calculating the crushing force, P_c , assuming for the sake of comparison two different assumptions for the strain rate sensitivity parameter sets: $D = 40.4$ and $q = 5$ used sometimes for mild steel and $D = 6844$ and $q = 3.91$. The impact of the missile described above to a rigid wall was numerically simulated with ABAQUS/Explicit finite element (FE) code. Figure 101 shows the axi-symmetric model (on the left) and the three-dimensional model (on the right). For the later tests,

simulations were conducted only with axisymmetric models, since they were found to be almost as precise as corresponding three-dimensional models.

The symmetry line is the dotted yellow line on the left. The model was given an initial velocity towards the rigid wall which is a few centimetres apart from the missile. Contact conditions were specified between the missile and the rigid target and also between the walls of the missile itself. The normal contact behaviour was so called hard contact which does not allow the surfaces to overlap each other. The tangential behaviour was friction with a coefficient of 0.2.

The material properties and wall thicknesses were assigned to different parts of the model. Approximately 500 linear 2-node structural shell elements were used for the axisymmetric model. Five integrations points were used through the element thickness. The three-dimensional model had 78310 linear 4-noded doubly curved shell elements with reduced integration.

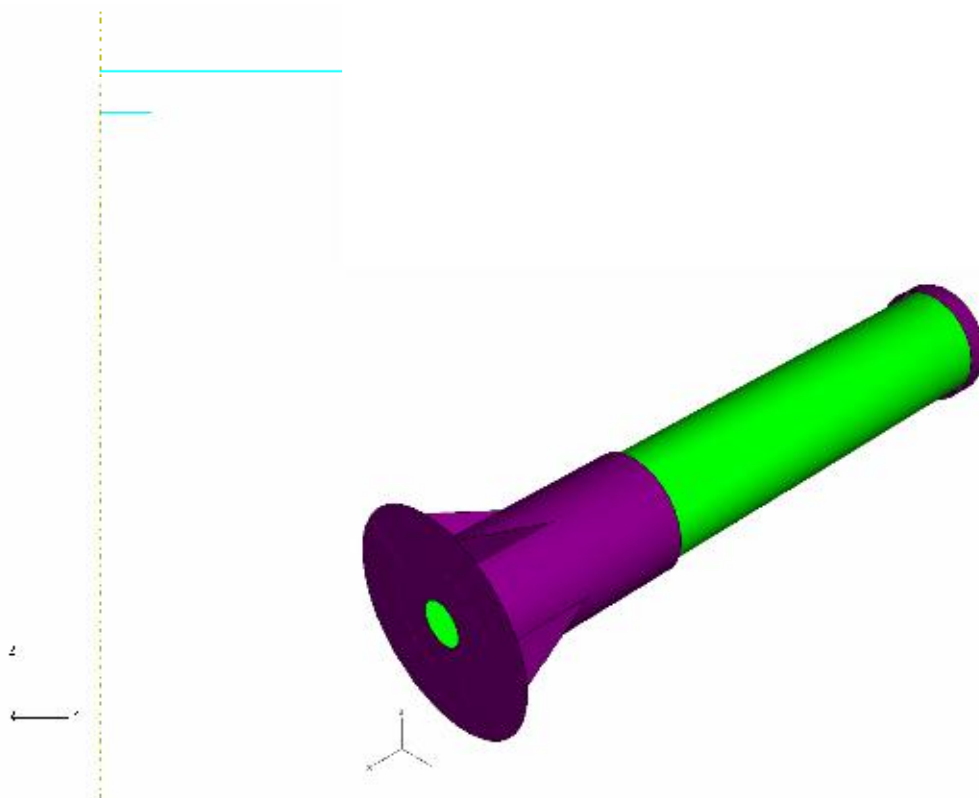

Figure 101. Axi-symmetric (on the left) and three-dimensional (on the right) FE models of the spiral-weld pipe.

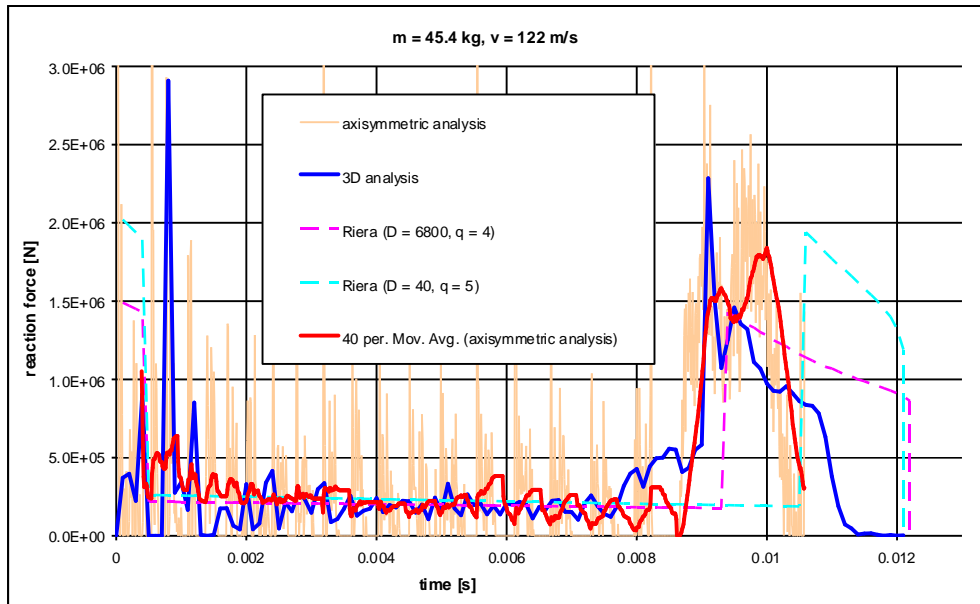

Figure 102. Reaction force in the 3D and axisymmetric analyses and in viscoplastic Riera calculations with two different parameter sets.

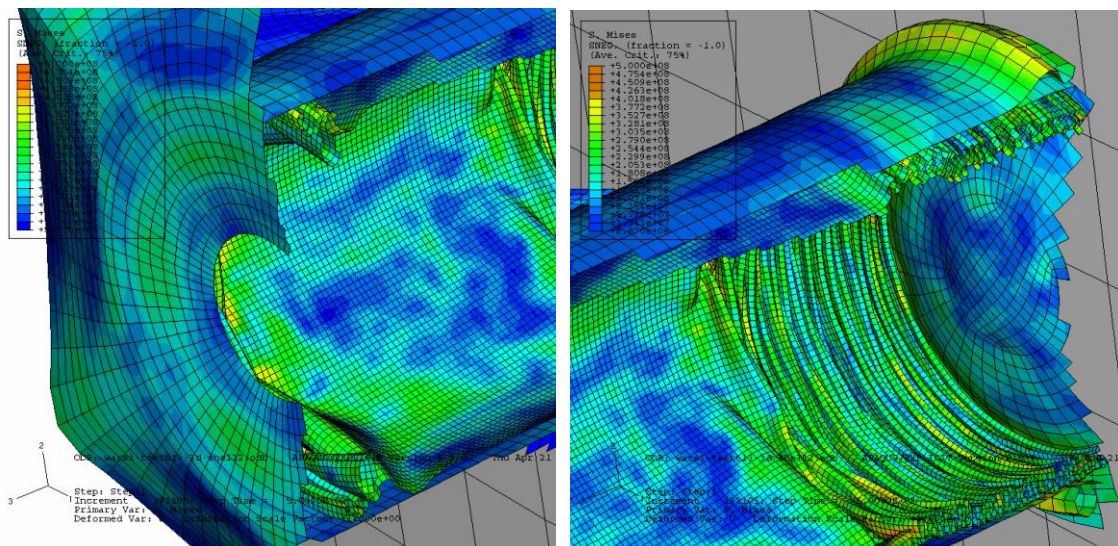

Figure 103. Von Mises stress distribution during the impact in the 3D model. The rear part is on the left and the front part on the right.

Figure 102 shows the reaction force in the impact as a function of time according to the three-dimensional and axisymmetric FE analyses and the corresponding load-time functions according to Riera approach with two different material parameter sets mentioned above. The red curve is an averaged curve of the force in the axisymmetric analysis. As can be seen, all the curves are quite similar and the methods are in a fairly good agreement.

Figure 103 shows von Mises stress distribution during the impact in the three-dimensional shell element model of the missile. The rear part is on the left and the front part on the right. The figure shows how the thin ventilation pipe was folded inside the thicker back part of the missile very much like in the real test.

Fuel dispersion considerations

The spreading of liquid fuel as a result of an intentional or accidental aircraft crash may cause a sudden fire with hazardous effects on the safety of the NPP. Very little experimental information concerning the fuel dispersal from impacted projectile can be found from the literature. Quantitative, experimental data e.g. on extent of liquid dispersal, liquid release velocity from projectile, droplet size, and spray cloud density is vital for the validation of the applied simulation techniques, and to provide boundary conditions for the assessment of fuel spreading and fire risk following an airplane crash. The impact tests conducted at VTT provide an excellent possibility to add this information [6].

The impact tests with fluid filled (“wet”) projectile covered the water masses from 15 to 68 liters, and the impact velocity ranged from 70 to 177 m/s. A customized measuring system to detect the important parameters related to liquid release and spreading from



Figure 104. A still figure of impacting steel pipe missile filled by water.

impacted missiles has been planned in WARSI project, and the system has been tested and applied in IMPACT project tests with liquid filled missiles [7]. The liquid release phenomena very close by the ruptured missile, and the spreading velocity and direction of the ejected liquid front were measured using the high-speed (1000 fps) FASTEC video cameras (Figure 104). The high-speed cameras were located so that the velocity both in the vicinity of the impact target and further away up to around 1.5–2 m from the target could be detected. High frame rate of the cameras enabled also information about the crush behaviour of the impacting missile.

Normal DV cameras (25 frames/s, 50 fields/s) were located around the target to detect the spreading angle, general view of the liquid spray, and the average velocity of liquid front up to around 5 m from the target. Wet area on the floor (pooling) caused by the liquid spilling was also measured. The measuring grid was drawn by chalk on the floor and the wet areas were photographed by digital cameras soon after the tests. Accumulation mass of liquid on selected locations on floor was roughly estimated in some tests using the steel trays gathering the liquid splashes. The extent of liquid dispersal was detected on the pure steel plates. The splashes and deposited droplets of liquid spray could be clearly seen and photographed on the plates using proper illumination. However, very small droplets could not be detected within this method, since e.g. droplets less than about 100 μm diameter will evaporate in an environment of 60% relative humidity within about 10–20 seconds i.e. much faster than the manual photographing could be performed after the test. Some oil-wetted plates were also located on the floor to capture the deposited droplets of liquid spray and to measure the final drop size using the macro photography technique and specific image analysis software. The oil used was very high-viscosity gearing oil with viscosity of 680 cSt (40°C).

A specific arrangement to photograph the size and velocity of single, airborne spray drops was also developed and tested. This system consisted of a high speed camera (1000 fps) and a high shutter speed camera ($t = 1 \mu\text{s}$, 25 fps) with double exposure. The cameras were located parallel about 2 m aside from the impact target. A stroboscope (flash time 1 μs) was used for the backward illumination for the high speed camera to arrest the motion of single drops. Good illumination enables depth of focus to be a couple of millimeters, if small iris is used. High frame rate enables good statistics to all droplets going through the measurement spot. If the velocity of droplets is small enough even the velocity of single drops can be determined.

An example of the measured velocity of liquid front to different radial directions from ruptured, cylindrical aluminium missile in one impact test is shown in Figure 105. Y-axis of the figure represents the ratio of liquid velocity to missile impact velocity. In spite of the fact that the first detected velocity point was at 0.4 m distance from the target, it is evident that the velocity of the liquid very near the missile is much higher

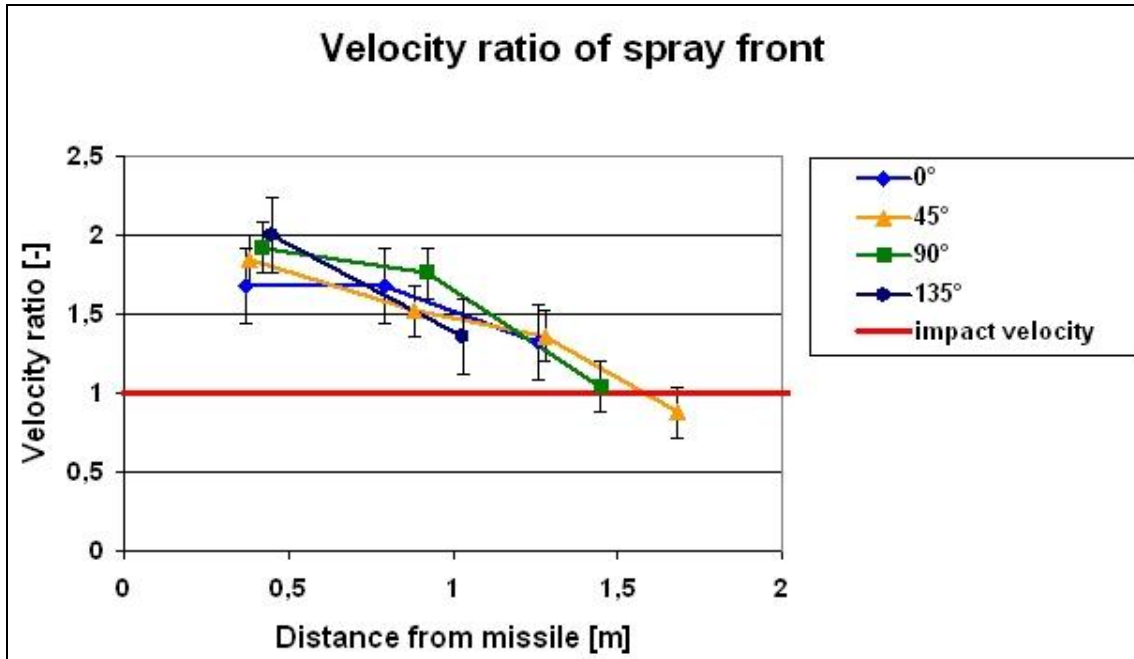

Figure 105. Measured ratio of liquid velocity to missile impact velocity to different radial directions from ruptured missile. (0° upward, 90° to the left direction)

than the missile impact velocity. The initial drops disintegrate probably very rapidly into smaller drops and the drag forces decelerate the droplet velocity. In the example, the velocity of spray front decreased to half of its initial value at about 1.5 m distance from the impact target. Figure 106 also indicates that liquid spreads partly asymmetrically around the missile depending on the crush mode of the missile.

To support the experiment design, the impact experiments were simulated using the Fire Dynamics Simulator (FDS) program [8]. FDS is a Navier-Stokes solver design for simulation of fires and the corresponding heat and mass transport processes. FDS uses Large Eddy Simulation (LES) technique to model the gas phase turbulence and Lagrangian particles to account for the two-phase flows. The purpose of the simulations was to assess the usability of the Fire Dynamics Simulator code (FDS) for the simulation of the two-phase flows involving high speed droplets, and to support the experimental work by providing initial estimate of the spray behaviour. The results included the spreading patterns in the experimental setup and spray propagation speeds and droplet concentrations as a function of the distance from the impact point. In the simulations, the effects of the droplet boundary conditions like speed, direction and size were studied, as well as the sensitivity of the results on the numerical parameter limiting the momentum transfer between the liquid and gas phases.

The simulation results indicated that FDS is a useful tool to simulate this kind of behaviour. The simulation results also showed that the effect of initial air speed, angle

of droplet release, drop size, and initial droplet speed are important parameters affecting the formation of the water cloud and final extent of liquid dispersal (Figure 106). The highest uncertainty is caused by the low Mach number assumption, which does not hold for some of the scenarios. However, the magnitude of the error caused by this assumption on the simulated spray behaviour is very difficult to estimate without a possibility to compare the results against some other code, being principally valid for the given problem. While the magnitude of this uncertainty is not estimated here, it may be assumed to be acceptable because after the impact, the speeds of both the gas and the liquid phase very rapidly slow down to level at which the assumption holds. In addition, the simulated distribution of the accumulated water on floor turned out to be sensitive to the numerical force term limiter used which must be further studied in more detail.

Next aim of the future simulations is to validate the FDS code results using the boundary conditions of real impact tests. The possibilities to scale up to the aircraft size should be also studied to find out the applicability of the model in the real problem. The ultimate goal is to replace the water by jet fuel and let the model predict the combustion hazard to the nuclear power plant.

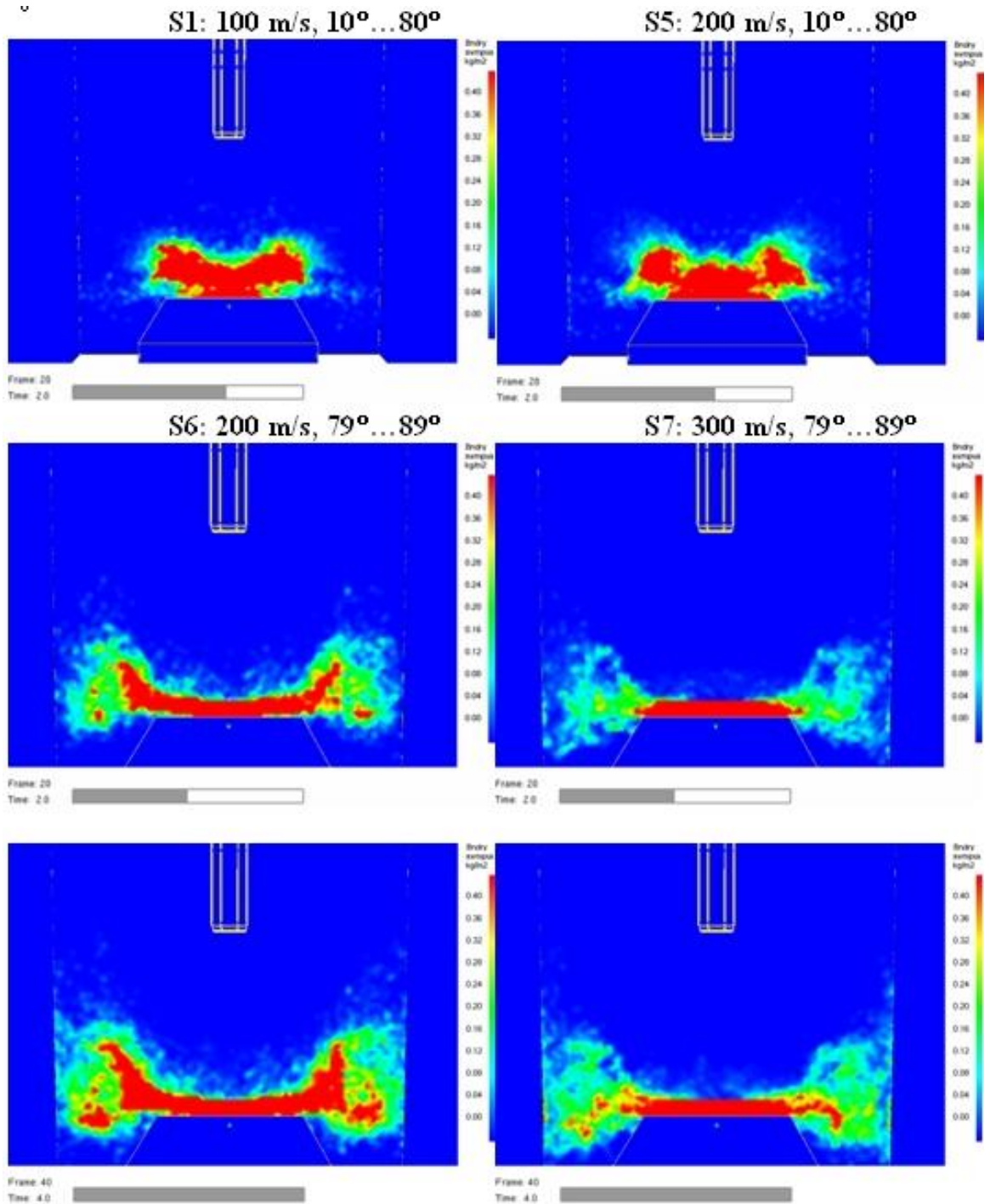

Figure 106. An effect of the droplet speed and spreading angle on the distribution of water on the floor predicted by FDS. Note that the results of S6 and S7 are given at times 2.0 and 4.0 s, while S1 and S5 at 2.0 s. The width of every image in the real scale is 10 m.

Conclusions

A test set-up for simulating in medium scale the impact of an aircraft against a nuclear power plant has been built up at VTT in Finland. This facility is capable of accelerating a 100 kg missile against a vertical wall at a maximum speed of 180 m/s. Higher velocities are feasible for smaller missiles. All lower capacity values are also possible.

Missiles of variable types have been used. Mainly cylindrical soft missiles have been used during this project. Other types of missiles to simulate the fuel tanks of an aircraft will be used in the future. In addition, missiles that resemble an aircraft with wings, engines etc. are foreseen. The missiles are accelerated to a final velocity either outside or inside of an acceleration tube. Therefore, the test system does not pose restrictions on the geometry of the missiles.

The target wall can be tailored separately to meet the experimental needs. The facility allows one to focus either on the missile behaviour (impacting a model missile against a simple rigid wall), or wall behaviour (impacting a simple missile against a model wall), or both at the same time. The facility is providing data needed to validate computer codes and models used to assess aircraft crashes on reinforced concrete structures, filling in the gaps in the international knowledge base on crucial items such as coupled mechanical loads, fuel dispersal, hard missile correlation “softening factors” and so on.

The impact force-time history of a deformable missile can be determined by the numerical finite element method and by simpler analysis methods such as Riera method, where the force-time function consists of the mass flow and of the crushing force of the missile. Both methods were used in the project. The static crushing forces of the missiles used in tests are assessed by static compression tests and corresponding numerical analyses. The strain rate dependency of the materials was taken into account by the Cowper-Symonds formula in both methods. All the finite element models used in this project were nonlinear both materially and geometrically. The nonlinear explicit time integration was used to solve the dynamic behaviour as a function of time. Especially the model mass was tried to make as close to the real one as possible. Some axisymmetric models included a tank with water in it. The water was modelled with a hydrodynamic material model in which the material’s volumetric strength is determined by an equation of state. In that case, mainly the first force peak was captured but after that the analyses were terminated due to overly large and fast deformations. The study to assess the hydrodynamic effect of a possible water hammer on the load-time function is still under way.

The main features of interest of the force-time function were for example the impact duration, the peak force values and most of all the total impulse of the impact. Also the

missile deformation in the tests and corresponding analyses were compared with each other. The main task that is to validate and further develop Riera method is very challenging, since all the methods and also the experimental measurements include uncertainties. On the basis of these different results it can be concluded that the measurements are most likely accurate and capturing the essential phenomena relating to the tests. The finite element results were in a good agreement with experimental results and are thus valuable in developing the simpler analytical method.

Recent tests have been made by accelerating the missiles above the acceleration tube onto the force plate or onto reinforced concrete test slabs. The behavior of the target slab is monitored by deflection transducers and strain gauges glued on the reinforcement bars. Some of these tests are simulated both with three-dimensional shell and solid element models, where the reinforcement bars and the whole target structure are taken into account. Careful pre-calculations are needed in order to achieve a desired collapse mode of the impact loaded reinforced concrete wall. The main difficulties are due to the span width limitations of the test frame. Especially, when seeking a collapse by bending, the collapse by punching must be prohibited by proper planning.

A measuring system to detect the important parameters related to liquid release and spreading from impacted missiles has been planned in WARSI project, and the system has been tested and applied in IMPACT tests with liquid filled (“wet”) missiles. The impact tests with wet missiles covered the water masses from 15 to 68 liters, and the impact velocity ranged from 70 to 177 m/s. Preliminary simulations to support the experiment design were performed using the Fire Dynamics Simulator (FDS) program.

In the most wet impact tests so far, the measured initial velocity of liquid ejected from the missiles was significantly higher than the missile impact velocity. On the other hand, the spray velocity decelerated very fast reaching the missile impact velocity at the latest at around 1–2 m distance from the impact target.

The first experiences indicate that FDS is a useful tool to simulate this kind of behaviour. The highest uncertainty is caused by the low Mach number assumption. The simulation results also showed that the effect of initial air speed, angle of droplet release, drop size, and initial droplet speed are important parameters affecting the formation of the water cloud and final extent of liquid dispersal. Next aim of the numerical simulations is to validate the FDS code results using the boundary conditions of real impact tests. The possibilities to scale up to the aircraft size should be also studied to find out the applicability of the model in the real problem. The ultimate goal is to replace the water by jet fuel and let the model predict the combustion hazard to the nuclear power plant.

References

1. Johnson, W. *Impact Strength of Materials*. Edward Arnold Ltd, London 1972. 361 p.
2. Riera, J. On the stress analysis of structures subjected to aircraft impact forces. *Nuclear Engineering and Design*, 8, 1968, pp. 415–426.
3. Laine, P. A blast tube in a test set-up to study the resistance of air-raid shelter facilities. Ms.Sc. Thesis. Helsinki University of Technology, Espoo 1965. 45 p.
4. Kärnä, T., Saarenheimo, A. & Tuomala, M. Impact loaded structures. In: SAFIR, The Finnish Research Programme on Nuclear Power Plants Safety. Interim Report, VTT Tiedotteita 2272, Espoo 2004. Pp. 113–122. ISBN 951-38-6515-0; ISSN 1235-0605. <http://virtual.vtt.fi/inf/pdf/tiedotteet/2004/T2272.pdf>.
5. Eriksson, E. 2004. The Crushing Forces of the Missile Body. MSc. Thesis. Tampere University of Technology.
6. Saarenheimo, A., Hakola, I., Hyvärinen, J. & Tuomala, M. Numerical and Experimental Studies on Impact Loaded Concrete Structures. Proc., of ICONE 14, International Conference on Nuclear Engineering. ICONE14-89477. July 17–20, 2006, Miami, USA.
7. Saarenheimo, A., Aalto, A., Calonius, K., Hakola, I., Hostikka, S., Kankkunen, A., Kärnä, T., Silde, A. & Tuomala, M. Numerical Studies for Impact Tests. Research Report BTUO72-051408. VTT. 27.2.2006.
8. McGrattan, K. *Fire Dynamics Simulator (Version 4) – Technical Reference Guide*, Special Publication 1018, National Institute of Standards and Technology, Gaithersburg, MD, 2004. 94 p.

16. Severe accidents and nuclear containment integrity (SANCY, 2003–2005) / Cavity phenomena and hydrogen burns (CAPHORN, 2006)

16.1 SANCY / CAPHORN summary report

Ilona Lindholm, Stefan Holmström, Jaakko Miettinen, Tommi Kekki, Pekka Pankakoski, Tuomo Sevón, Eveliina Takasuo, Jouko Virta & Riitta Zilliacus
VTT

Abstract

SANCY and CAPHORN projects investigated physical phenomena related to severe nuclear accidents with importance to Finnish nuclear power plants. Currently the major topics are the ex-vessel coolability issues, long-term severe accident management and containment leak tightness, hydrogen combustion, and adoption and development of new calculation tools considering also the needs of the future Olkiluoto 3 plant. The projects employed both experimental and analytical methods.

Introduction

The objectives of the projects were to reduce remaining uncertainties of severe accident phenomena that are important to Finnish nuclear power plants. These issues comprise the core melt coolability, severe accident management in the long time range and updating of analytical tools to cover also the needs of Olkiluoto 3 in addition to the existing plants. Such analytical tools are e.g. the French TONUS code for hydrogen distribution and combustion studies, NUCLEA/GEMINI code for determination of phase diagrams of various core melt mixtures and WABE code for 2D/3D assessment coolability of heat generating particle beds.

Furthermore, the follow-up and participation of major international research projects in the area of severe accidents is carried out as part of the project.

One important goal was to aid in maintaining competence in severe accident area in Finland by engaging experts from various fields of science and by providing education by doing for young students.

Main objectives

The STYX experiments aim at completion of concise data base on particular debris bed coolability in the containment for Finnish nuclear power plants, in particular for Olkiluoto BWRs.

The long-term accident management studies will focus on assessing the survivability of containment penetration seal materials under high radiation doses, elevated temperatures and prevailing chemical environment.

The project aims at acquisition and implementation of new computer codes applicable also to Olkiluoto 3 plant. Also own computer codes will be developed utilising the information obtained from international experimental programs, in particular for melt coolability.

Project also follows-up the OECD/MCCI project investigating melt coolability and concrete erosion issues. Maintenance and updating of MELCOR code is performed in connection of participation to USNRC/CSARP programme.

Particle bed dryout heat flux experiments

The STYX facility for measurement of particle bed coolability tests was constructed for the dry-out heat flux tests of particle beds in the previous MOSES project of the FINNUS programme [1]. The STYX tests were continued in the succeeding SANCY project with tests employing heavier top layer material in the stratified geometry and with different bed heights to investigate the effect of bed depth on dryout heat flux.

The first test series was performed with a constrained (net on the top) stratified bed of alumina particles in the STYX test rig [2]. The second test series was with a top layer of ferrochrome (FeCr) [3]. The density of ferrochrome is 1.6 times that of alumina. The effective grain size of FeCr was measured by Fortum NS to be 0.13–0.15 mm [4]. The sieved grain size of the fine sand was 0.2–0.4 mm. The measured dryout heat fluxes in the first and second stratified test sets are presented in Table 17.

Table 17. Dryout heat fluxes of stratified beds measured in STYX facility.

Pressure/ Dryout power and heat flux	2 bar	4 bar	7 bar
No net, alumina top layer	205–221 kW/m ²	–	348–361 kW/m ²
Net on top of fine layer, alumina top layer	208–221 kW/m ²	294–307 kW/m ²	242–256 kW/m ²
Ferrochrome top layer, initial pressurization with air	215–240 kW/m ²	393–420 kW/m ²	325–337 kW/m ²

The third test set employed beds with different heights: 200, 400 and 600 mm [5], [6]. Also the density of heater levels in the bed was increased in the third test set up. In the bed of 200 mm the heater elements were too close to each other and were considered to have disturbed the measurements and these results are not considered representative. Experiments were performed for both homogeneous beds (400 and 600 mm) and for stratified beds with a layer of 40–67 mm of fine sand added on top of the respective homogeneous bed.

Figure 107 illustrates the measured dryout powers for homogeneous and stratified beds of 600 mm in the third test setup. The homogeneous bed resulted practically the same dryout powers as before with the sparser heater level configuration (green and red dots). In the stratified bed the dryout power was reduced by 0–11 % in comparison to the homogeneous bed. The dryout power became smaller as the average fine particle diameter was reduced. This is according to the existing models. However, the measured dryout powers were much higher than predicted for stratified beds by the existing correlation models.

The dryout power increased as the bed depth decreased. Also the reduction of dryout power in the respective stratified bed became more distinct. The thicker the fine top layer was (60 mm vs. 40 mm) the larger difference there was in comparison to the homogeneous bed. But still, the magnitude of the dryout heat flux in the stratified 400 mm bed remained higher than predicted by the models. In all but one stratified test the top layer was not heated. The heating of the top layer did not have a significant difference to the dryout heat flux. The most likely explanation for the relatively high dryout heat fluxes in the stratified beds is the channel formation in the fine sand that allows better steam removal/water penetration to the bed.

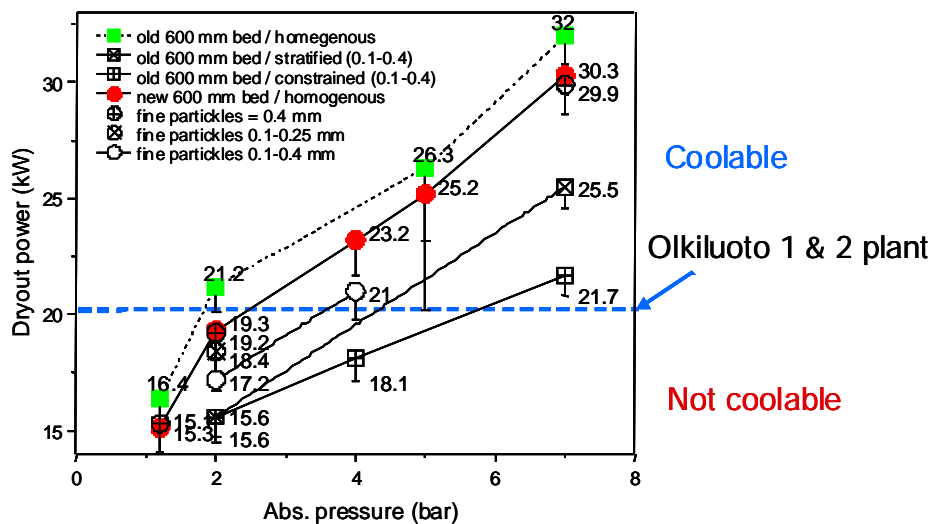

Figure 107. All measured dryout heat fluxes in the STYX tests with bed depth 600 mm. Homogeneous and stratified bed geometries.

On the basis of performed work it can be concluded that multi-grain sized, irregular particles should be characterised with significantly smaller average particle diameter in comparison to mass-averaged value. Theofanous-Saito correlation predicts best the behaviour of the homogeneous STYX beds. Stratified beds with thin top layer resulted in higher dryout heat fluxes than predicted by Lipinski-1D model. The reason may be fluidisation and/or channeling of the top layer. Plant scale margins to coolability may be lower than previously assumed (especially at lower pressures). The effects of 2D-geometry of the beds should also be investigated with more advanced computer codes, like the WABE code.

Seal material irradiation tests

Seal material behaviour under exposure to radiation during a long period of time after a severe accident is investigated with irradiation and material property testing of real seal material samples.

The first tested material was butyl rubber used in Olkiluoto 1 and 2 in personnel hatch in the upper drywell and in service door in the transport shaft [7]. The second material was EPDM (ethylene-propylene-diene- terpolymer) employed as seals of cable penetrations in OL-1 and 2. The maximum cumulative dose to the butyl rubber samples was about 0.9 MGy corresponding to the estimated cumulative dose of walls during the first year after a hypothetical severe accident. The effects of seal material being in contact to caustic solution resulting from accident management has been accounted for in the testing. Also the period of elevated temperature in the upper drywell prior to completion of containment water filling has been accounted for in the testing. The material properties of butyl rubber were significantly affected already with the shortest irradiation time corresponding to a cumulative dose in the containment after about 2 months from the accident. Butyl rubber became softer as the cumulative dose increased and the deterioration of material was visible. EPDM in turn retained reasonably well all measured material properties even at the highest cumulative dose. With visible examination the test samples looked intact. The material tests revealed that the e.g. the maximum strain was 40% of the original value after radiation dose equivalent to one year after severe accident. EPDM tended to become harder and more brittle as the cumulative dose increases.

The third test series was performed for two silicon rubber materials, Q2000 and Silastic GP-70 [8]. Silastix GP-70 is used in personnel hatches in Loviisa plant. The survivability of the material properties of silicon is between EPDM and butyl rubber. Also silicon lost its elasticity properties and became harder as the dose rate increased.

Comparison of the results from the irradiation and material testing with the materials tested in SANCY project (butyl rubber, EPDM and silicon) shows that EPDM (ethylene-propylene-diene- terpolymer) is most resistant for higher irradiation doses [1]. In the tensile strength test the maximum load is almost double compared to that of Q2000 silicon rubber, which had the second highest tensile strength. Both EPDM and silicon rubber are hardened because of the irradiation according to the Shore A test. Butyl rubber in turn became softer as the cumulative dose increased.

Adoption of GEMINI2/NUCLEA thermochemical database

The GEMINI2/NUCLEA code system was purchased from French company Thermodata and implemented at VTT Processes [9]. The GEMINI2 code using NUCLEA database allows the user to calculate the phase diagrams of metal-oxide mixtures encountered in various in-vessel and ex-vessel core melts for further use in assessments of severe accident phenomena. The model estimates complex multiphase multicomponent chemical equilibria (ideal gaseous phase, stoichiometric condensed substances and multicomponent condensed solution phases) by minimization of the total Gibbs energy of the system under either constant pressure or volume conditions.

The code was used to determine the liquid fractions of a typical in-vessel and ex-vessel melt pools in typical PWR and Olkiluoto 1 and 2 and Loviisa VVER plants plants with varying mass fractions of dissolved concrete. A case with melt composition specified for Loviisa is presented in Figure 108.

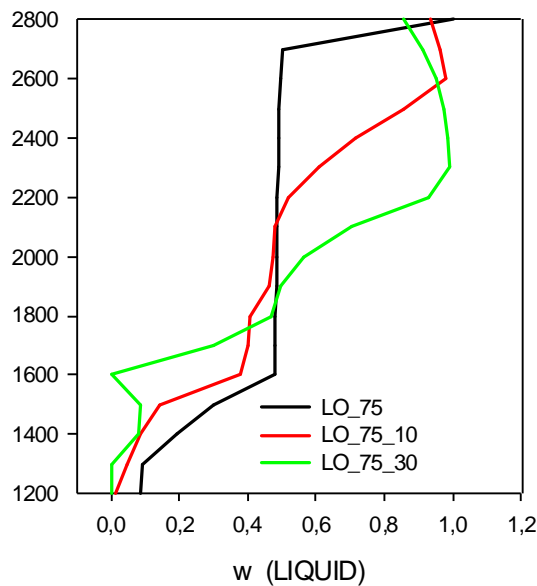

Figure 108. Illustration of melt mixture liquid fraction vs. interface temperature in a system of Loviisa core melt (75 % of Zr oxidised) with 0, 10 and 30 % of siliceous concrete in the mixture [10].

TONUS 2D/3D computer code for hydrogen distribution and combustion studies

The TONUS code is a 3D code developed at CEA, France for hydrogen risk studies. The code was acquired to VTT in 2006 for possible future use in technical licensing support for STUK concerning hydrogen combustion in particular for the Olkiluoto 3 plant (OL3). One research scientist visited the CEA/Saclay for a period of 3 months to get user training of the code use as well as to learn the modelling principles of the code.

During the visit two different FLAME experiments were calculated with TONUS code to test the applicability of the code for flame acceleration calculations. FLAME experiments were performed in the 1980's in the Sandia National Laboratories and the test facility comprised a long, horizontal rectangular channel with possibilities to install flow obstacles in the channel walls for turbulence generation. The purpose of the test was to investigate acceleration of flame speed. Two tests were calculated; one without flow obstacles and one with flow obstacles. The same tests have been previously calculated with FLUENT CFD code at VTT [11]. A more detailed discussion of the TONUS work is presented by Takasuo in [12].

The assessment of TONUS code is continuing currently in calculation of ENACEFF experiments performed by IRSN, France. The ENACEFF facility is a vertical tube with a larger dome volume on top. This test setup is closer to the postulated problem geometry in a nuclear power plant, e.g. OL3. The results of these analyses will become available by mid 2007.

Acquisition of WABE 2D computer code for particle bed coolability studies

The WABE code is developed at IKE Stuttgart, Germany and it facilitates modelling of coolability of axisymmetric particle beds. The code model accounts for the effects of coolant entrance to the bed from the sides as well as from above or from below. The code was obtained via EU SARNET Project and one research scientist visited IKE for one week to get user training of the code use.

In the first calculations of STYX test 2.4 the heating power in WABE input is defined to be increasing linearly from 100 to 190 W/kg between 0–2000 s, and constant 190 W/kg after that. According to WABE code the hottest region is at the elevation 10–12 cm from the bottom of the bed (Figure 109). In the experiments the dryout occurred 5 min after increase of heating power to 191 W/kg. Figure 110 shows the respective saturation profile in the bed.

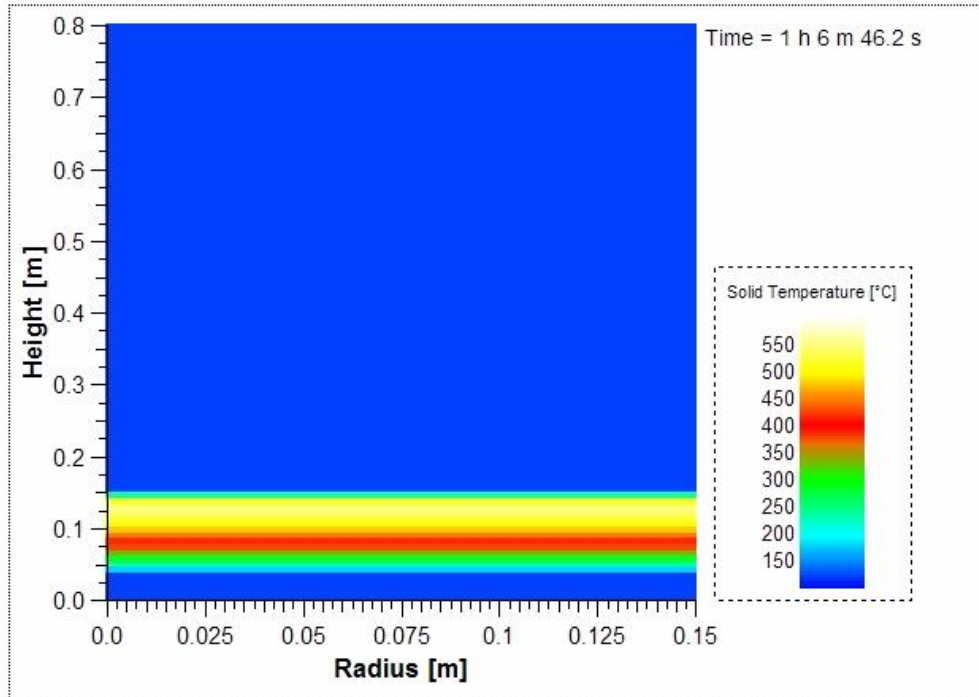

Figure 109. Temperature profile of STYX test 2.4 (homogeneous 600 mm bed, pressure 2 bar) at 2000 s after the incipient dryout calculated with WABE code.

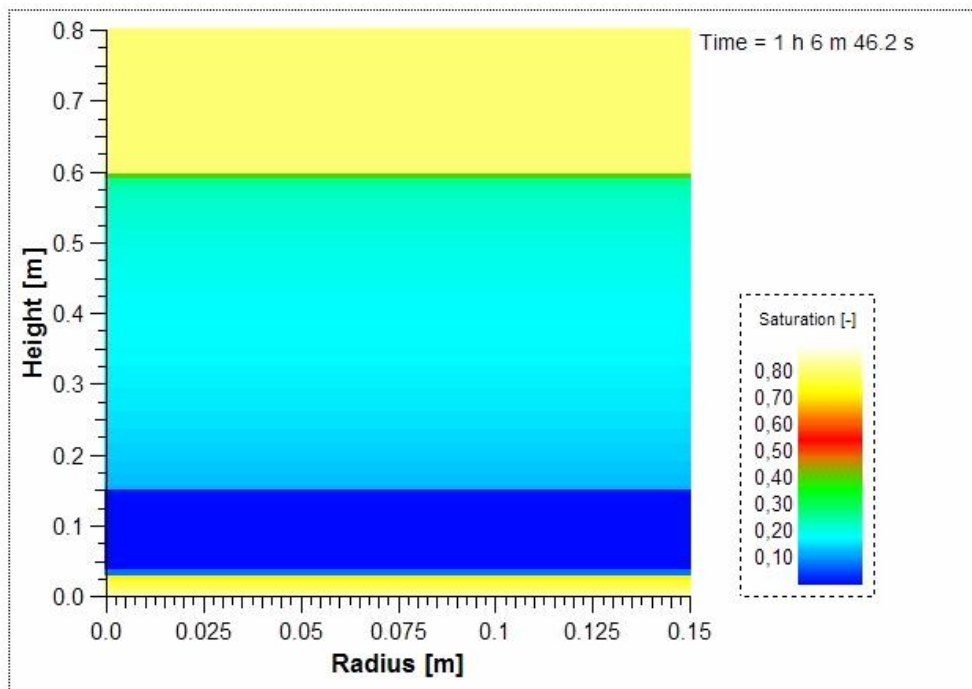

Figure 110. Saturation profile of STYX test 2.4 at 2000 s after the incipient dryout calculated with WABE code. The particle bed is dry on locations where the saturation is zero and completely filled with water on locations where saturation is 1.

Design and construction of HECLA facility for investigations of molten metal-concrete interactions

The purpose of the HECLA tests is to investigate molten metal-concrete interactions during a postulated severe accident. The specific goal of HECLA tests is to investigate the effect of molten metal on sacrificial concrete used in the dry cavity of OL3. In addition to erosion rate by melting the occurrence of mechanical erosion, e.g. spallation of concrete, will be investigated. HECLA test facility is located in Otaniemi at the facilities of VTT's Production Systems (Figure 111).

The rough design of the test facility and test matrix was performed as master's thesis [13]. The updated, current test matrix is shown in Table 18. The melt is generated in an induction furnace capable of melting max 50 kg of stainless steel (Figure 112). The melt is poured into the test section that is kept in inert N₂ gas atmosphere inside the test cabin (Figure 113). The target is to employ superheated melts (~400°C) which means initial melt temperatures of about 1900°C. Concrete erosion is measured with K-type thermocouples embedded into the concrete at different locations at each location at different depths. The melt temperature is measured manually in the induction furnace with a dip-in thermocouple. The opening for the melt jet at the furnace end is 13 mm in diameter. The initial melt pool diameter in the concrete crucible is 26 cm. The measurement of the melt pool temperature is under development. The scoping test will employ two type C thermoelements in quartz glass tubes.

The melt generation and pouring capabilities was demonstrated by melting 40 kg of iron and by pouring it into an inert ceramic test vessel without proper temperature measurement in the crucible. The crucible with embedded thermocouples of the first test (scoping test) has been cast and the test is scheduled for late 2006. The majority of the HECLA tests are planned to be performed in the next two years in the project COMESTA.

Table 18. The current HECLA test matrix.

Test No.	Melt	Concrete	Schedule
Melt generation development test	40 kg iron	inert ceramic	6/2006
Scoping tests	20 kg iron	siliceous Finnish concrete	12/2006
1	50 kg iron	iron oxide concrete	2007
2	50 kg stainless steel	iron oxide concrete	2007
3	50 kg stainless steel+ Zr	iron oxide melt	2008
4	50 kg stainless steel+ Zr	siliceous concrete	2008



Figure 111. The HECLA test facility. The blue cabin houses the concrete crucible.



Figure 112. Top view of the induction furnace and vessel with melt flow path opening for melt.

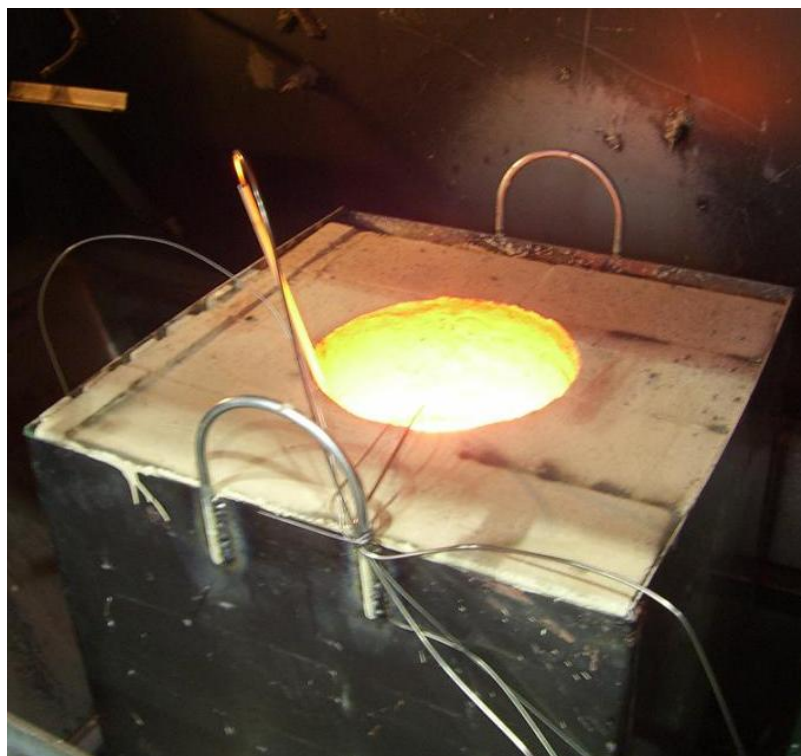

Figure 113. Top view of the inert test section with molten iron inside. Development test for melt generation and pouring.

Miscellaneous work and international follow-up

OECD/MCCI and MCCI-2 projects performing tests on water ingress and melt eruption coolability mechanisms, solidified core melt (crust) structural strength and material properties and 2-D core melt-concrete interaction has been participated. Information of the obtained results and project progression have been realised in form of technical travel reports and technical data reports have been further distributed to STUK, TVO and Fortum.

USNRC/CSARP programme meetings have been participated. MELCOR 1.8.6 code version was obtained to Finland via participation to CSARP. Olkiluoto 1 & 2 plant input has been updated for MELCOR 1.8.6 [14]. COMET L2 and L3 benchmark exercise organized in the frame of EU SARNET project has been participated with MELCOR 1.8.6 code [15].

Applications

STYX particle bed experiments can be applied to assess the debris bed coolability in Olkiluoto BWR containment. The test data have been applied to model development. Seal material testing gives prototypical data applicable in assessment of long term containment leak tightness following a severe accident. Similar data is sparse or does not exist internationally. GEMINI2 has been already been used to other nuclear safety applications outside SANCY project. The acquisition, implementation and learning to use in SANCY project has facilitated timely start of other uses. TONUS code provides a tool for independent hydrogen combustion evaluations in technical licensing support of OL3 for STUK. WABE code provides an advanced tool for assessment of debris bed coolability in OL1 and 2 plants for safety evaluations. HECLA tests will give information of the behaviour of the new iron oxide concrete type under thermal-chemical attack by in-vessel metallic melt.

Conclusions

Important new data on particle bed coolability have been obtained in the new STYX experiments. The dryout heat fluxes of homogeneous beds with wide particle size distribution may be lower than generally expected and on the other hand shallow, non-heated layers of fine particles may not reduce the dryout heat flux as much as predicted by the models.

New data have been produced on long-term behaviour of containment seal materials exposed to high radiation rates and chemical environment after a severe accident. This type of data is sparse or non-existing. In general the material properties of the seals are significantly changed already in a couple of months after a severe accident.

New calculation tools for assessments of severe accident phenomena have been adopted (GEMINI2, TONUS, WABE, MELCOR 1.8.6).

New test facility, HECLA, has been constructed for investigation of thermal-chemical attack of in-vessel metallic melt on Finnish concrete types. The experiments will give information on the behaviour of new iron oxide concrete used in the dry cavity of OL3. These tests are to be conducted in the project COMESTA of SAFIR2010.

References

1. Lindholm, I., Holmström, S., Miettinen, J., Lestinen, V., Hyvärinen, J., Pankakoski, P. & Sjövall, H. Dryout heat flux experiments in heterogeneous particle bed. Nucl. Eng. Des. 236 (2006), pp. 2060–2074.
2. Holmström, S., Pankakoski, P. H. & Hosio, E. 2003. STYX dryout heat flux testing with constrained stratified bed. Espoo: VTT Industrial Systems. Research Report No. BTUO74-031179. 20 p.
3. Holmström, S., Pankakoski, P. H. & Hosio, E. 2004. STYX dry-out heat flux testing with dense top layer bed. Espoo: VTT Industrial Systems. Research Report No. BTUO74-031202. 30 p.
4. Kokkonen, I. 2004. Permeability measurements for STYX-5 experiment. Vantaa: Fortum Nuclear Services, Report TERMO-305.10 p.
5. Holmström, S., Pankakoski, P. & Hosio, E. STYX dry-out heat flux testing with different test bed thicknesses: Part I: the 200 and 400 mm test beds, Research Report BTUO74-041303, 11.1. 2005. 14 p. + app. 4 p.
6. Holmström, S., Pankakoski, P. & Hosio, E. STYX dry-out heat flux testing with different test bed thicknesses: Part II: homogeneous and stratified tests with 600 and 400 mm test beds, Research Report BTUO74-051381, 20.12. 2006. 19 p. + app. 26 p.
7. Zilliacus, R. & Joki, H. The irradiation tests of sealing materials, Project Report PRO1/P1006/05, 10.5. 2005. 19 p.
8. Zilliacus, R. & Joki, H. The irradiation tests of silicone rubbers, Research report VTT-R-00899-06, 14.2.2006. 9 p.

9. Kekki, T., Zilliacus, R. & Lindholm, I. Implementation of NUCLEA database for in- and ex-vessel applications, Project Report PRO1/P7018/04, 2.5.2005. 15 p. + app. 2 p.
10. Kekki, T., Zilliacus, R. & Lindholm, I. GEMINI Calculations for Loviisa and MET-1 Test Cases, Project Report PRO1/P1024/05, 20.12, 2005. 16 p. + app. 2 p.
11. Takasuo, E. & Kudriakov, S. Modeling of the FLAME hydrogen combustion tests F-8 and F-22 using the TONUS CFD code, CEA Report SFME/LTMF/RT/06-046/A. (To appear).
12. Takasuo, E. & Kudriakov, S. Modeling of the FLAME hydrogen combustion tests F-8 and F-22 using the TONUS CFD code, SAFIR Final Report.
13. Sevón, T. Molten Core – Concrete Interactions in Nuclear Accidents| Theory and Design of an Experimental Facility, VTT research Notes 2311, Espoo 2005. ISBN 951-38-6743-9; 951-38-6744-7.
<http://virtual.vtt.fi/inf/pdf/tiedotteet/2005/T2311.pdf>.
14. Sevón, T. Updating of Olkiluoto 1&2 BWR Model to MELCOR Version 1.8.6, Research Report VTT-R-08033-06, 11.9.2006. 25 p.
15. Sevón, T. Simulation of COMET-L2 Melt-Concrete Interaction Experiment with MELCOR, Research Report VTT-R-04325-06, 3.5.2005. 8 p.

16.2 Modeling of the FLAME hydrogen combustion tests F-8 and F-22 using TONUS CFD code

Eveliina Takasuo, VTT
Sergey Kudriakov, CEA Saclay

Abstract

In the present study, the FLAME large-scale hydrogen combustion tests F-8 and F-22 performed at Sandia National Laboratories, USA, were simulated using the TONUS CFD code. In test F-8 a configuration without obstacles and no top venting was used. The objective of the calculation of test F-8 was to investigate the effect of two different boundary condition specifications at the test channel exit as well as the effect of mesh refinement. The difference between the tested boundary conditions was observed to be significant. The CREBCOM combustion model was used in the simulation and attention was paid at finding an appropriate model parameter K_0 for the current test.

Test F-22 which includes obstacles resulting in a 33% blockage ratio in the test channel was modeled by the CREBCOM and $k-\varepsilon$ turbulence model with Eddy Break-Up reaction kinetics. Both models were found to perform qualitatively well for both 2D and 3D models of the system. However, it was observed that the correlations presently available for the key parameter K_0 of the CREBCOM model are not suitable for the FLAME tests. In test F-22, an additional challenge was provided by the unclear conditions near the exit of the channel and it was noticed that high local pressure peaks were formed near the obstacles in the channel.

Introduction

Hydrogen risk is an important concern in nuclear reactor safety since considerable amounts of hydrogen can be released into the containment as a result of oxidization of zirconium fuel cladding by steam during a core melt accident. Several modes exist in which hydrogen combustion can occur, ranging from slow deflagrations in which the velocity of the combustion front is considerably less than the speed of sound to supersonic detonations which cause severe dynamic pressure loads.

There are numerous studies on determination of the critical conditions for flame acceleration (FA) and deflagration-detonation-transition (DDT) in closed domains. The effect of transverse venting on the processes of FA and DDT has also been studied by Sherman et al. [11], Ciccarelli et al. [5] and Alekseev [1]. The critical conditions for FA and DDT in the latter situation are much less understood compared to those in closed systems. Previous simulations of the FLAME tests include calculations of the tests F-8

and F-22 using FLUENT by Manninen et al. [9] at VTT Technical Research Center of Finland, as well as the validation of FLACS code performed by Hansen et al [8]. The two tests presented in this study were selected to be the same as the tests in [9] since comparisons of the results obtained by different CFD codes is planned in a future study.

The end of the FLAME channel is open to the atmospheric air which requires the definition of a numerical boundary at the exit. A main goal of the study is to test the effect of the boundary by using a simple computational domain and an extended domain. The other objectives are investigating the effect of mesh refinement and validating the CREBCOM and $k-\epsilon$ models used in the TONUS code by evaluation of the values for CREBCOM model K_0 parameter and Eddy Break-Up constant.

FLAME test results

The FLAME facility consists of a horizontal 30.5 m long rectangular channel with the width and height of 1.83 m and 2.44 m, respectively, made of reinforced concrete. The dimensions were selected to be half-scale of the upper plenum region of an ice condenser of a PWR containment. The schematic of the facility is presented in Figure 114.

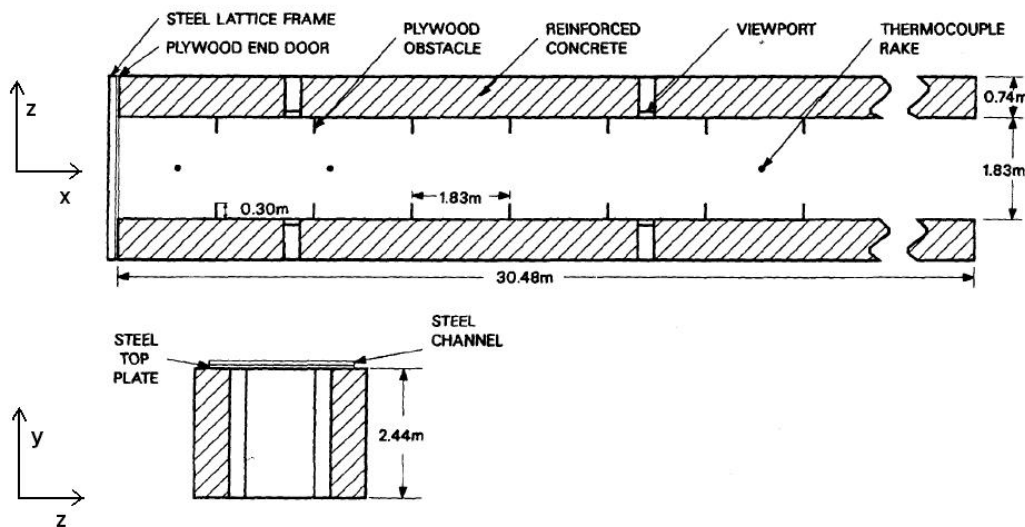

Figure 114. The FLAME test facility [10].

Prior to the test the channel is filled with a hydrogen-air mixture. Mixing fans are used to ensure a uniform distribution of hydrogen into the volume. The mixture is ignited near the end which is sealed with a plywood door and a steel lattice frame. The top of FLAME is covered with steel plates which can be moved for different arrangements of top venting. In tests F-22 simple plywood baffles with the blockage ratio of 33% were used [11].

In test F-8 flame acceleration to 170 m/s was measured at the last 10 m of the channel and the measured peak overpressure was 26 kPa. In test F-22 the planar flame speed reaches 700 m/s approximately at 1/2 of the channel length at which it propagates until the exit. Due to the enhanced turbulence caused by the obstacles the flame velocities are higher than in F-8. A strong pressure peak of 3.2 MPa was observed at the channel exit which according to [11] indicates that a DDT occurred near the exit even though a detonation wave was not observed.

Physical and numerical modeling

The CREBCOM combustion model is the principal tool for combustion analysis in TONUS. The model has been developed for the simulation of combustion in geometries which are larger than the characteristic dimensions of the physical phenomena involved [2], [4], [7]. The thermal conduction and species diffusion which are the dominating phenomena in a deflagration propagation are not directly modeled: their action is taken into account by introducing an experimentally derived correlation source term into the Euler equations. The governing equations of the model are

$$\frac{\partial \rho}{\partial t} + \vec{\nabla} \cdot (\rho \vec{u}) = 0 \quad (1)$$

$$\frac{\partial \rho Y_k}{\partial t} + \vec{\nabla} \cdot (\rho \vec{u} Y_k) = \rho \omega_k \quad (2)$$

$$\frac{\partial \rho \vec{u}}{\partial t} + \vec{\nabla} \cdot (\rho \vec{u} \otimes \vec{u} + P\mathbf{I}) = \rho \vec{g} \quad (3)$$

$$\frac{\partial \rho e_t}{\partial t} + \vec{\nabla} \cdot (\rho \vec{u} h_t) = \rho \vec{g} \cdot \vec{u} - \rho \sum_j \nabla h_{f,j} \omega_j + S_{cr} \quad (4)$$

$$\frac{\partial K_0}{\partial t} + \vec{\nabla} \cdot (\rho \vec{u} K_0) = 0 \quad (5)$$

$$\frac{\partial Y_{H2,f}}{\partial t} + \vec{\nabla} \cdot (\rho \vec{u} Y_{H2,f}) = 0 \quad (6)$$

$$\frac{\partial Y_{H2,i}}{\partial t} + \vec{\nabla} \cdot (\rho \vec{u} Y_{H2,i}) = 0 \quad (7)$$

The combustion progress variable is defined as

$$\xi(r, t) = \frac{Y_{H_2}(r, t) - Y_{H_2,i}(r, t)}{Y_{H_2,f}(r, t) - Y_{H_2,i}(r, t)} \quad (8)$$

and the reaction rate for the progress variable

$$\dot{\omega}_\xi = \frac{K_0}{\Delta x} \cdot \{criterion_function\} \quad (9)$$

In a computational cell (l,m,n) the criterion function is equal to 1.0 if the following condition is valid

$$\varepsilon^2 = \xi_{l+1,m,n}^2 + \xi_{l-1,m,n}^2 + \xi_{l,m+1,n}^2 + \xi_{l,m-1,n}^2 + \xi_{l,m,n+1}^2 + \xi_{l,m,n-1}^2 - 3\xi_{l,m,n}^2 \quad (10)$$

Otherwise, it is equal to 0.0 and no combustion occurs in the cell. The model key parameter is K_0 which defines the combustion rate. It can be determined by trial-and-error or by experimental correlations. The following three methods are available for deflagration regime. Method I is described by Efimenko in [7]:

$$K_0 = S_T \frac{\rho+1}{4} = \frac{S_T}{S_L} \frac{\sigma+1}{4} S_L \quad (11)$$

The turbulent burning rate S_T is found by experimental correlations

$$\frac{S_T}{S_L} = 0.5(\sigma-1) \frac{L}{\delta}^{1/3} Le^{-2/3}, \text{ high turbulence } L/\delta > 500 \quad (12)$$

$$\frac{S_T}{S_L} = 0.0008(\sigma-1)^3 \frac{L}{\delta}, \text{ low turbulence } L/\delta < 500$$

where S_L is the laminar burning rate, L the integral length scale of turbulence, δ the laminar flame thickness and σ the expansion ratio. Method II is described by Dorofeev [6]:

$$K_0 = S_T \frac{\sigma+3}{8} = \frac{S_T}{S_L} \frac{\sigma+3}{8} S_L \quad (13)$$

Method III is described in [10]:

$$K_0 = 66.7 \cdot S_L \quad (14)$$

In TONUS, alternatively to the CREBCOM model combustion and fluid flow can be modeled by the Reynolds-Averaged Navier-Stokes equations with k- ϵ closure model in which the chemical reaction is modelled by an Eddy Break-Up (EBU) model. A finite-volume approach is used in the discretization of the equations. The convective fluxes are discretized by the Van-Leer-Hänel Flux Vector Splitting Method or by the Colella-Glas Scheme (Shock-Shock Method). The diffusive fluxes (applicable in the k- ϵ model) are discretized by approximating edge center gradients of the primitive variables using their cell-centered values. The method of approximation is the “diamond” method described in Beccantini [3].

CREBCOM model simulation

The computational grids used in the simulation of test F-8 are presented in Figure 115. The red zone is the ignition domain which is used to start the combustion by giving the species mass fractions and temperature values corresponding to already burnt gas AIBC conditions.

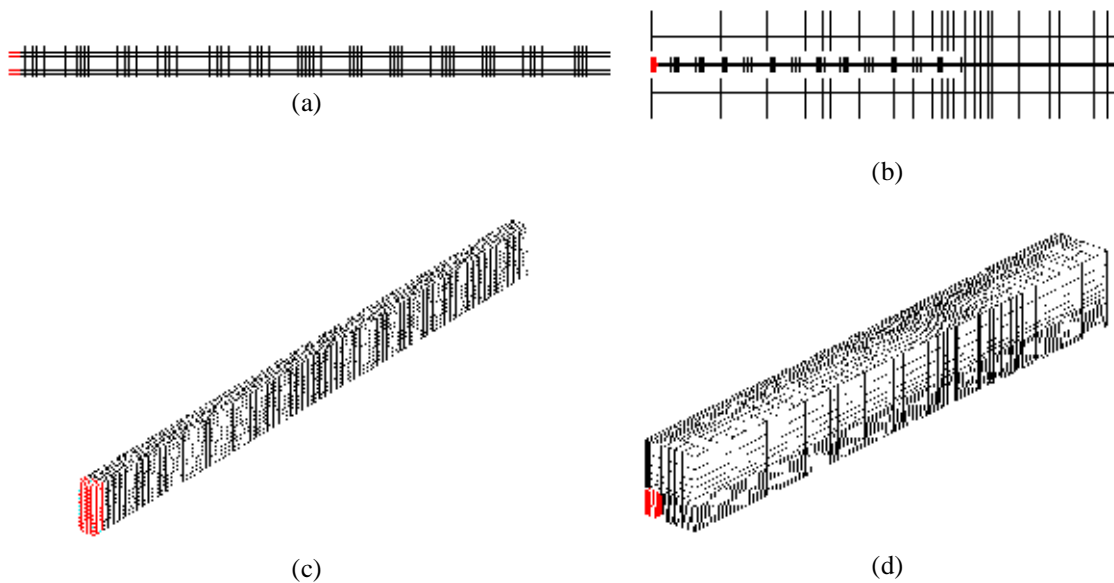

Figure 115. Computational meshes. (a) basic 2D mesh with 1350 elements, (b) extended 2D mesh with 2704 elements, (c) basic 3D mesh with 9000 elements, (d) extended 3D mesh with 22572 elements.

The K_0 for the test was defined by comparing the results of different K_0 to experimental results which resulted in $K_0 = 2.0$ m/s. The values predicted by correlations (11)–(14) are

- Method I: $K_0 = 601.0$ m/s
- Method II: $K_0 = 43.0$ m/s
- Method III: $K_0 = 81.7$ m/s.

These values are significantly too high and it can be concluded that the correlations are not suitable for the present open geometry. A pressure and flame speed comparisons to the test results are shown in Figure 116 (a) and Figure 116 (b).

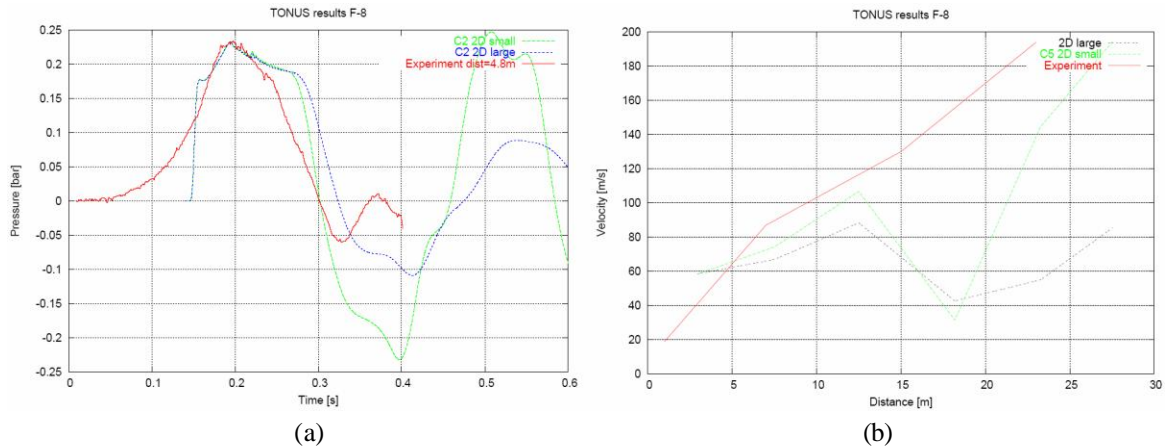

Figure 116(a). Pressure evolution comparison in test F-8. (b) Flame speed vs. distance along the test channel.

The first pressure peak seen in the results is the pressure wave which is set forth by the deflagration. After the pressure wave has exited the channel there is a region of underpressure at the outlet which results in reversed fluid flow from the atmosphere (or the pressure boundary) creating a ‘reflected’ pressure wave. This second pressure rise is highly exaggerated in the small basic grid case and the pressure starts to oscillate strongly after the flame has exited the channel. The large extended grid shows a better agreement with the test results. The simulation flame speed does not show a similar acceleration as the test since the reversed flow also affects the apparent flame velocity. The numerical boundary conditions for pressure values together with the simplified chemical model greatly affect the computational results. Similar results are also obtained by using a mesh with double density with somewhat higher pressure peaks as expected using a Finite Volume Method.

K-ε turbulence model simulation

The results for pressure and flame speed in the k-ε simulation of test F-22 are shown in Figure 117. The eddy break-up constant for the reaction rate was defined by trial-and-error resulting in the value $C_{EBU} = 6.5$. The present model also shows a pre-compression of gas in the corners formed by the walls and the obstacles prior to combustion. The compressed gas is then burnt resulting in a pressure peak which can be as high as 3.6 MPa as shown in Figure 118 which represents the pressure field near the channel exit. In reality, the obstacles made of plywood would be destroyed before such

high pressure values are achieved but the results give the impression that a local explosion could explain the DDT reported by Sherman et al. [11].

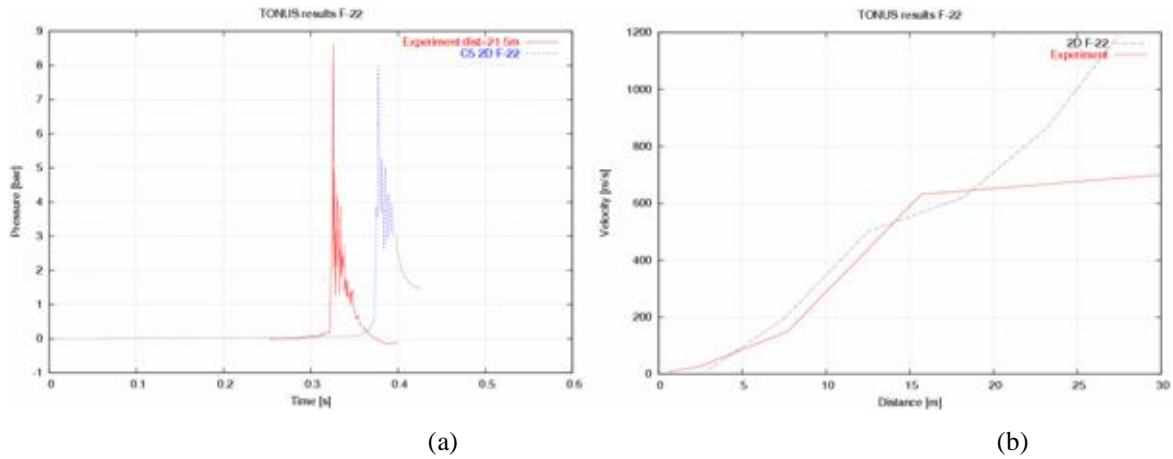

Figure 117. (a). Pressure evolution comparison in test F-22. (b) Flame speed vs. distance along the test channel.

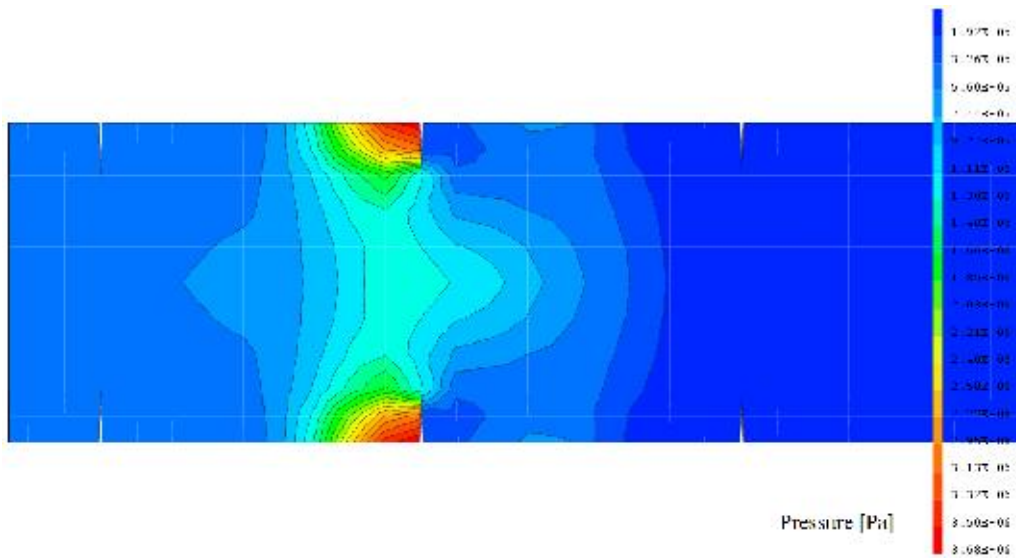

Figure 118. Pressure at $t = 0.3825$ s in test F-22.

Conclusions

For the test F-8, comparing the results between the basic mesh (boundary condition at the channel exit) and the large mesh cases, the large extended computational domain was found to perform significantly better. Qualitatively, the CREBCOM model was found to capture the pressure loads realistically in the test F-8. A drawback of the model is that the correlations that are available for the parameter K_0 which defines the combustion rate are not capable of predicting the parameter in the FLAME test since the correlations were developed for closed volumes.

The test F-22 was simulated using both the CREBCOM and k- ϵ models. The k- ϵ calculations show a good agreement with the experimental results and the pressure behavior is more realistically modeled as in the CREBCOM case. However, the CREBCOM model is computationally less expensive and suitable for conservative estimations of pressure loads, provided that an appropriate K_0 is found.

Modeling of the test F-22 is complicated because of the flame acceleration and reported DDT near the exit in the experimental results. The absence of a retonation wave in the test in case of DDT and the fact that high pressure peaks were observed in the simulation next to the obstacles raised some discussion about the nature of the phenomena at the exit: it is unclear whether a detonation, “a quasi-detonation” or a local effect in a corner that was witnessed in the test.

References

1. Alekseev, V. I., Kuznetsov, M. S., Yankin, Y. G. & Dorofeev, S. B. Experimental study of flame acceleration and the deflagration-to-detonation transition under conditions of transverse venting. 2001. *Journal of Loss Prevention in the Process Industries* 14 (2001), pp. 591–596.
2. Beccantini, A. Implementation of CREBCOM combustion model in TONUS code. Technical Report DM2S, SFME/LTMF/RT/01-017/A (2001).
3. Beccantini, A. & Gounand, S. Evaluation of the Diffusive Terms of the Navier-Stokes Equations via a Cell-Centered Finite Volume Approach. 2002. Technical Report DM2S, SFME/LTMF/RT/02-024/A (2002).
4. Beccantini, A. & Kudriakov, S. Modelling of Hydrogen Combustion in TONUS V2006.1. Technical Report DM2S, SFME/LTMF/RT/06-027/A (2006).
5. Ciccarelli, G., Boccio, J., Ginsberg, T., Finfrock, C., Gerlach, L., Tagawa, H. & Malliakos, A. The effect of lateral venting on deflagration-to-detonation transition in hydrogen-air steam mixtures at various initial temperature. 1998. NUREG/CR-6524, BNL-NUREG-52518. USNRC, Washington DC.
6. Dorofeev, S. Redlinger, R. Description of FLAME3D. 2003. Internal report. Forschungszentrum -IKET, Karlsruhe.
7. Efimenko, A. A. & Dorofeev, S. B. CREBCOM code system for description of gaseous combustion. 2001. *Journal of Loss Prevention in the Process Industries* 14 (2001), pp. 575–581.

8. Hansen, O. R., Renoult, J., Sherman, M. P. & Tieszen, S. R. Validation of FLACS-HYDROGEN CFD consequence prediction model against large scale H₂ explosion experiments in the FLAME facility. 2005. 1st International Conference on Hydrogen Safety, September 8–10, 2005. Pisa, Italy.
9. Manninen, M., Lindholm, I. & Silde, A. Hydrogen Combustion in Olkiluoto Reactor Building: Assessment of Flame Acceleration, Onset of Detonation, and Detonation Loads. 1999. Espoo, Finland, VTT Energy, Research Report ENE21/20/99. 34 p.
10. Pailhories, P. Bilan des calculs de combustion multi-D réalisés avec le modele CREBCOM du code TONUS. Note technique IRSN/DSR, (2003).
11. Sherman, M. P., Tieszen, S. R. & Benedick, W. B. FLAME facility. The Effect of Obstacles and Transverse Venting on Flame Acceleration and Transition to Detonation for Hydrogen-Air Mixtures at Large Scale. 1989. Washington D.C, USA, Office of Nuclear Regulatory Research, USNRC, NUREG/CR-5275, SAND-1264 141 p.

17. Fission product gas and aerosol particle control (FIKSU, 2003–2004) / Behaviour of fission products in air-atmosphere (FIKA, 2005–2006)

17.1 FIKSU-FIKA summary report

Ari Auvinen, Jorma Jokiniemi, Raoul Järvinen, Jussi Lyyränen, Jouni Pyykönen,
Unto Tapper & Seppo Vanttinen
VTT

Abstract

FIKSU and FIKA projects have been a combination of studies related to severe accident issues. Participation in the follow up, interpretation and design of international PHEBUS FP, ISTP and ARTIST programs are described in this summary report. Experiments on ruthenium oxidation and transport in air ingress accidents are treated in a separate special report.

Introduction

The PHEBUS FP program is an international cooperative research program to develop experimental data for validating computer codes used for severe reactor accident analysis. The PHEBUS FP experiments simulate the major aspects of a severe accident, beginning with the degradation of irradiated reactor fuel, release of fission products, transport of fission products through a simulated reactor coolant system, and injection of these fission products into a model of reactor containment. Fission product behavior within the containment is examined over a period of about five days. This examination includes study of both aerosol behavior and the chemistry of radioactive iodine.

The Phebus FP program is conducted by IRSN in association with the European Commission JRC, EdF and American, Canadian, Japanese, Korean and Swiss nuclear safety organizations. Launched in 1993 with an initial test, it has an estimated cost of €300 million. Each experiment is prepared with meticulous care, making extensive use of predictive calculations obtained using a variety of software programs. In this way, the experimental protocol can be established and the criteria for ending the experiment defined. On November 18, 2004 after four years of preparation, the fifth and last meltdown experiment took place in Cadarache, France.

International Source Term Program (ISTP) is a cooperative research program on severe accidents based on separate-effect experiments. The program provides complementary

data from analytical tests to refine the existing severe accident modelling. The main part of the work is related to iodine chemistry studies in the reactor cooling system (RCS) and in the containment, ruthenium chemistry in the containment, oxidation of Zircalloy cladding in air and degradation of B₄C control rods.

Sequences such as a steam generator tube rupture (SGTR) with stuck-open safety relief valve represent a significant public risk by virtue of the open path for release of radioactivity. The release may be lessened by deposition of fission product containing aerosol on the steam generator (SG) tubes and other structures or by scrubbing of these particles in the secondary coolant. The absence of empirical data, the complexity of the geometry and controlling processes, however, make quantifying the retention very difficult. Therefore credit for Fission Product (FP) retention is not taken in risk assessments. In ARTIST experimental program conducted at Paul Scherrer Institute (2003–2007), Switzerland, the retention of aerosol-borne fission products in the SG secondary is studied.

Main objectives

The ongoing PHEBUS FP program is the centrepiece of an international co-operation investigating, through a series of integral in-pile experiments, key-phenomena involved in the progression of a postulated severe accident in a light water reactor (LWR). Its objective is to provide further insight into the complex phenomena encountered during this type of accident. This should improve the actions taken to limit the impact of the accident by providing more accurate assessments, and optimize the emergency plans set up around plants.

The dedicated PHEBUS facility offers the capability to study the degradation of real core material, from the early phase of cladding oxidation and hydrogen production up to the late phase of melt progression and molten pool formation. The subsequent release of fission products and structural materials is also experimentally studied, including their physicochemical interactions, their transport in the cooling system, and their deposition in the containment. The revolatilisation of iodine due to radiochemical effects in the water of the sump and the amount of low-volatility FPs and transuranium elements reaching the containment are receiving a special interest, as large uncertainties related to their modelling exist.

The partners in PHEBUS FP program contribute both separate effects test results and analyses to aid in the interpretation of the integrated test results. These contributions have been organized into Interpretation Circles that intensively examine individual aspects of the integral phenomenological tests. Results of these examinations are reported to a Scientific Analysis Working Group that makes recommendations to a

Steering Committee concerning work needed and plans for tests. The main objective in the SAFIR program is to provide assistance especially in the interpretation of fission product transport, iodine chemistry and as well as in the optimisation of experimental instrumentation.

Based on the results obtained from PHEBUS FP program, a set of separate effect experiments has been defined. These experiments should solve remaining uncertainties, which can not be addressed in integral experiments. The objective of ISTP is to provide data on Zircalloy oxidation in air and steam, the impact of B₄C on fuel degradation, chemical forms of fission products in the RCS, silver reactions with iodine and production of organic iodides in the containment. The need for experiments on fuel collapse and fission product release from the fuel is under assessment. In SAFIR program the objective is to help in designing the facilities and the experiments as well as interpretation of the experimental results.

The objective of ARTIST-programme is to provide a comprehensive database to support safety assessments and analytical models in the case of SGTR accidents. VTT has expertise in conducting experiments and modelling on aerosol resuspension, which is considered to be a key uncertainty in SGTR sequences. In SAFIR-programme VTT also provides aerosol measurement instrumentation and expertise for integral ARTIST-experiments.

Main results

The experiments in the PHEBUS-FP program are providing data that are valuable for validating and refining computer codes used to assess the safety of the currently operating plants and to check the efficiency of accident management procedures. They will also support the design of future plants having the capacity to confine core melt-down accidents within their containments.

The main findings in PHEBUS FP experiments include:

- Oxidation runaway was more violent than predicted in high steam flow rate. Cladding dislocation criteria has to be revised for such case.
- Fuel collapse took place earlier than predicted mainly due to interactions of fuel with other materials such as Zircalloy.
- The overall released amount of volatile fission products was well reproduced with existing models. However, coupling between fuel degradation and FP release is important, when release kinetics is modelled.

- Modelling of semi-volatile fission products (such as Molybdenum) has to be further improved.
- Structural, control rod and fuel material release is important for chemical speciation of fission products and for prediction of aerosol mass and behaviour in the circuit and in the containment.
- Chemical forms of important fission products Cs, I and Te are currently not known in the circuit.
- Early presence of gaseous iodine was observed in the containment in most experiments. In FPT-3 experiment conducted with B₄C control rod the fraction of gaseous iodine was especially large.
- Partly oxidised silver reacted with iodine in the sump water to form non-soluble species and thus reducing drastically gaseous iodine production by radiolysis.
- Production of organic iodides in the containment is suspected have taken place mainly due to interactions of I₂ with paint. A deeper knowledge on interactions is needed for proper modelling of the interactions.

Based on work completed in SAFIR program a recommendation was given to quantify fission product deposition in a section of PHEBUS FP circuit upstream of the steam generator [1]. In PHEBUS FPT-3 experiment approximately one third of cesium core inventory was found from that section. Although the results are yet to be confirmed, a reassessment of fission product mass balance also in FPT-2 experiment has been initiated. Most likely the results related to fission product transport in primary circuit have to be reviewed in all previous PHEBUS FP experiments.

For the first time in PHEBUS FP program, aerosol size distribution was successfully measured in FPT-3 experiment with instrumentation tested and partly designed in SAFIR program. Gamma emission profile of an impactor used at point G (cold leg) of the circuit is presented in Figure 119 [2].

Analysis of the iodine measurements conducted for PHEBUS FPT-1 experiment lead to a significant improvement of aerosol filtration efficiency in various iodine measuring devices [3]. In FPT-3 experiment the instrumentation performed very well enabling reliable division between gaseous iodine and iodine carried in aerosol particles.

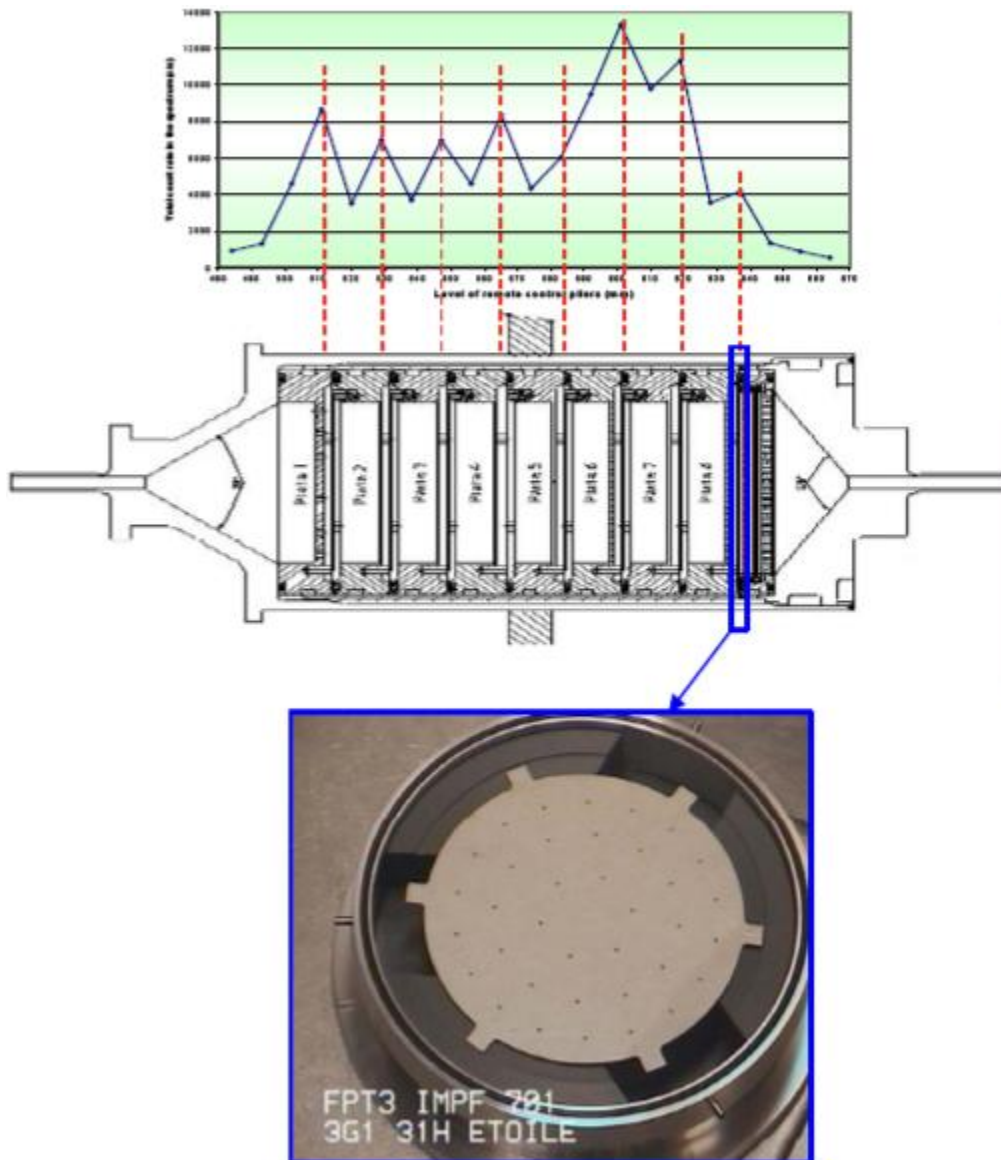

Figure 119. Particle size selective gamma emission profile measured in the cold leg of PHEBUS FP circuit during FPT-3 experiment [2].

In the frame of SAFIR program a sampling and dilution system for both hot and cold leg of the CHIP-facility applied in the International Source Term Program was designed [4]. The work included the conception of the sampling and quenching system with necessary flow controls as well as temperature and pressure measurements. The system is remotely controlled by computer, which also enable realtime logging and adjustment of all necessary parameters. Sampling system was dimensioned to fit to the expected experimental conditions. Error caused by non-optimal sampling due to variation in the experimental conditions was estimated. During the project a prototype diluter was build in order to test a new low-loss dilution concept enabling controlled sampling of aerosol and vapours at 1000°C. The performance of the designed diluter in the CHIP experiments was simulated using Fluent CFD -code.

In two last integral experiments in the ARTIST-facility VTT provided aerosol instrumentation and expertise enabling quantification of particle retention in the facility. Such information was deemed crucial for the success of the experimental series. VTT also defines the shape factor of aerosol particles applied in the ARTIST experiments. According to NRC, shape factor is one of the most important and previously unknown parameters affecting aerosol transport in the primary circuit. At separate effect experiments VTT is developing a database for aerosol deposition and resuspension in turbulent internal tube flow.

Applications

The five large-scale tests of the PHEBUS-FP program are supported by numerous separate effects tests and extensive test analyses from a number of perspectives by the international community participating in this program. Data from the tests have been applied to refine models of core degradation and fuel relocation, hydrogen production, and fission product speciation. Experiments have also been used in more recent evaluations of the radioactive releases to be considered in the preparation of emergency plans.

Furthermore, the OECD has chosen the second experiment in the program as a reference for an International Standard Problem for benchmarking computer codes used for severe accident analyses. The exercise involved 30 organizations from 20 countries aimed at testing the performance of various severe accident simulation codes.

Development of sampling systems in the frame of ISTP projects is aiming at online measurements of fission product chemistry in conditions relevant to primary circuit hot leg. Such measurement system would provide information on one of the most significant uncertainties related to severe accidents, if follow-ons to the PHEBUS FP experiments are ever to be conducted.

ARTIST experimental program provides an estimate of aerosol retention into the structures of vertical steam generator in case of a SGTR scenario. Currently, the absence of experimental data prevents taking credit of particle retention in risk assessments. Database developed in separate effect experiments at VTT is applied by VTT, IRSN and University of Newcastle in modelling transport of particles in turbulent flow.

Conclusions

The PHEBUS FP program has proven to be an important corner stone in validation and development of computer codes used for severe accident analysis. Experiments have not only provided valuable data but also pointed out areas, where current understanding is

not sufficient. Such areas like fission product chemistry in the primary circuit or aqueous and gaseous chemistry of iodine within the reactor containment are currently addressed in the frame of International Source Term Program.

Investigations carried out in the frame of SAFIR program have been an integral part of the PHEBUS FP program. They have provided important information on mass balance and primary circuit transport of the fission products as well as means to improve aerosol and iodine measurements in the experiments.

References

1. Auvinen, A. & Jokiniemi, J. Aerosol deposition into Phebus FPT-1 steam generator. VTT Processes Project Report PRO3/P11/03, 2003.
2. Zeyen, R., Albiol, T. & Melis, J. PHEBUS FP Program semi-annual progress report October 2004 – March 2005. DPAM/DIR 2005-0172, 47RS1110CR, May 2005.
3. Girault, N., Dickinson, S., Funke, F., Auvinen, A., Herranz, L. & Kraussmann, E. Iodine behaviour under PWR accidental conditions: lessons learnt from the two first Phebus tests. Nuclear Engineering and Design, 2006, Vol. 236 (12), pp. 1293-1308.
4. Auvinen, A., Jokiniemi, J., Lyyräinen, J., Pyykönen, J. & Vanttinen, S. CHIP-Facility sampling and quenching system, VTT Processes Project Report PRO3/P3048/05, 2005.

17.2 Experiments on the behaviour of ruthenium in air ingress accidents

Teemu Kärkelä, Ulrika Backman, Ari Auvinen, Riitta Zilliacus, Maija Lipponen,
Tommi Kekki, Unto Tapper & Jorma Jokiniemi

VTT

Abstract

In this project the release, transport and speciation of ruthenium in conditions simulating an air ingress accident was studied. Ruthenium dioxide was exposed to oxidising environment at high temperature (1100–1700 K) in a tubular flow furnace. At these conditions volatile ruthenium species were formed. Majority of the released ruthenium was deposited in the tube as RuO_2 . Depending on the experimental conditions ~1–26 wt-% of the released ruthenium was trapped in the outlet filter as RuO_2 particles. In stainless steel tube ~0–8.8 wt-% of the released ruthenium reached the trapping bottle as gaseous RuO_4 . A few experiments were carried out, in which revaporisation of ruthenium deposited on the tube walls was studied. In these experiments oxidation of RuO_2 took place at a lower temperature. During revaporisation experiments 35–65% of ruthenium transported as gaseous RuO_4 . In order to close mass balance and achieve better time resolution four experiments were carried out using a radioactive tracer.

Introduction

During the operation of a nuclear reactor, ruthenium will accumulate in the fuel in relatively high concentrations. In an air ingress accident, ruthenium may form volatile oxides, which may be released to the containment. As the radiotoxicity of ruthenium is high in both short and long term, the understanding of its transport and speciation is of primary importance in case of an air ingress accident.

When RuO_2 is exposed to oxygen at high temperature, it reacts to form RuO_3 and RuO_4 . At temperatures below approximately 700°C RuO_3 becomes thermodynamically unstable and decomposes to RuO_2 . RuO_4 does not necessarily decompose upon cooling as it is metastable. It has been found to exist in appreciable amount at ambient temperature. [1]

Experimental facility

The experimental facility used in the ruthenium experiments is schematically presented in Figure 120. The main component of the system was the tubular flow reactor (Entech, ETF20/18-II-L), in which the ruthenium source (RuO_2 powder) was oxidised at high temperature. The tubular flow reactor used was 110 cm long and had two heating zones, each 40 cm long. The tube material in the reactor was high purity alumina. The ceramic crucible with the RuO_2 powder (about one gram per experiment) was placed over the second heating zone of the reactor.

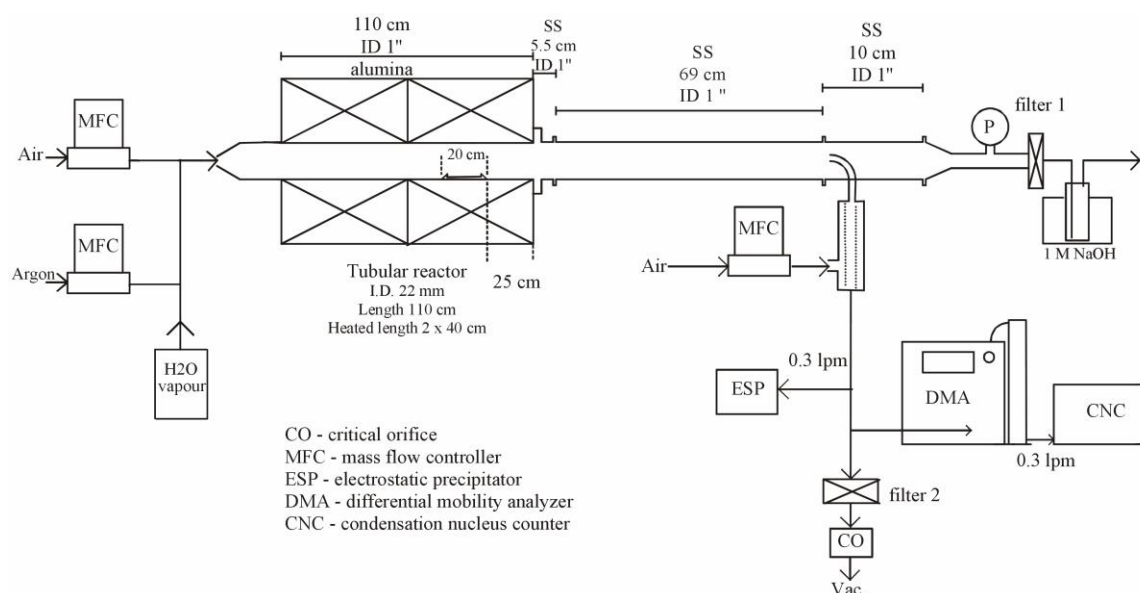

Figure 120. Experimental set-up for ruthenium experiments.

The non-condensable gas flow through the furnace was controlled with mass flow controllers (Tylan FC-2900M, Brooks 5851S). Water was added to the gas stream either by saturating air flow in a bubbler, placed in temperature controlled water bath (temperature 30°C), or by adding superheated steam directly into the gas stream. Saturated air-flow went through an inlet heated up to 70°C . During steam feed gas flow was heated to 100°C before entering the reactor.

As the gas stream exited the reactor, it cooled in a stainless steel (AISI 316L) tube and the gaseous ruthenium oxides decomposed partly to RuO_2 particles. Aerosol particles were filtered out at point 106 cm downstream of the reactor. The filters used were polycarbonate plane filters (Nuclepore). Gaseous ruthenium was trapped downstream of the filter in a 1 M NaOH-water solution. The bubbler containing the trapping solution was placed in an ice-bath.

Gas-phase sampling was done at point 74 cm downstream of the reactor using a j-shaped probe pointing upstream in the flow. The sample was diluted with a porous tube diluter minimising the losses during the process. The number size distribution of the particles was measured with differential mobility analyser (DMA, TSI 3081) and condensation nucleus counter (CNC, TSI 3022). The particles are size classified according to their electrical mobility by the DMA. The CNC counts the number of particles in each size class. The system was controlled with the Aerosol Instrument Manager Software version 4.0 (TSI). The gas flow in the sampling line was filtered before being vented to the fume hood, using the same type of filter as in the main line. Transmission electron microscopy (TEM) samples were collected on holey carbon coated copper grids using an electrostatic precipitator (ESP). Aerosol sampling was not conducted in radiotracer experiments.

The analysis of samples was done with instrumental neutron activation analysis (INAA). The detection limit for ruthenium with INAA using 3 hour irradiation time is 2 µg/sample. The amount of the solution that can be irradiated in the reactor limits the determination of ruthenium from liquid samples. Therefore, the trapping solution was heated on a sand bath and ethanol was added to reduce ruthenates to RuO₂. The solution was filtered and ruthenium on the filter paper was irradiated for 1 minute. Gamma measurements of the irradiated filters were conducted one day after irradiation. Aerosol filters applied in the experiments were analysed similarly using INAA.

Experiments

Thirteen experiments have been carried out during the project. At the time of the writing four more experiments are to be conducted using gaseous RuO₄ feed. The details of the experiments can be found in Table 19. The objective of the experiments was to determine the effect of oxidation temperature and steam content on the transport of ruthenium oxides. The furnace temperature was varied between 1100 K and 1700 K. In first three experiments and in the sixth experiment the gas flow was saturated with water vapour at 30°C. In the other experiments different amounts of steam and argon were injected into the gas stream, while oxygen partial pressure was kept constant. One experiment, n:o 9, was conducted with dry air. In revaporisation experiments the reactor set point and the furnace tube was the same as used in the previous experiment in the Table 19. However, ceramic crucible with RuO₂ powder was removed from the furnace. All ruthenium released in the revaporisation test was thus deposited on tube surfaces in the previous experiment. Radioactive tracer was applied in four experiments in order to close the mass balance, to measure deposition profile and to get on-line data about the behaviour of ruthenium during experiment. During the experiments the gas flow through the reactor was 5 l/min (NTP).

Table 19. Details of the experiments during years 2005–2006.

Exp.	Reac- tor T [K]	Flow rate [lpm]	Gas	Tube material (from furnace to filter)	Duration [min]	Other
1	1300	5	Air sat. w. H ₂ O	SS (106 cm)	45	-
2	1700	5	Air sat. w. H ₂ O	SS (106 cm)	40	-
3	1700	5	Air sat. w. H ₂ O	SS (96 cm)	360	revaporisation
4	1500	10	Steam/Ar/ Air25/45/30	SS (106 cm)	23	higher flow rate
5	1100	5	Steam/Ar/ Air10/60/30	SS (106 cm)	372	-
6	1500	5	Air sat. w. H ₂ O	SS (106 cm)	41	radiotracer
7	1300	5	Steam/Ar/ Air10/60/30	SS (106 cm)	45	radiotracer
8	1300	5	Steam/Ar/ Air50/20/30	SS (106 cm)	45	radiotracer
9	1300	5	Air	SS (106 cm)	45	radiotracer
10	1700	5	Steam/Ar/ Air10/60/30	SS (106 cm)	40	-
11	1700	5	Steam/Ar/ Air10/60/30	SS (106 cm)	190	revaporisation
12	1500	5	Steam/Ar/ Air10/60/30	SS (106 cm)	46	-
13	1500	5	Steam/Ar/ Air10/60/30	SS (106 cm)	190	revaporisation
14	1500	5	Air sat. w. H ₂ O	Al ₂ O ₃ (106 cm)		RuO ₄ injection
15	1500	5	Air sat. w. H ₂ O	Al ₂ O ₃ (106 cm)		RuO ₄ injection radiotracer
16	1500	5	Air sat. w. H ₂ O	SS (106 cm)		RuO ₄ injection radiotracer
17	1500	5	Air sat. w. H ₂ O	Al ₂ O ₃ (106 cm)		RuO ₄ injection radiotracer SS plates

Results

The results are summarised in Table 20. The results are normalised to a flow rate of 5 l/min (NTP), because the carrier gas flow rate through the main line filter and the trapping bottle was not, due to sampling, the same in all experiments. The amount of released ruthenium is measured by weighting the crucible before and after the experiment. Mass of ruthenium in bubbler and in filter is determined with INAA. In the estimation of ruthenium release and transport rates it was assumed that the rates are constant throughout the experiment. The result for ruthenium aerosol mass on filter in experiment 2 is not correct, because all ruthenium could not be analysed.

Table 20. Results of the experiments on the behaviour of ruthenium. Presented values are masses of released and transported ruthenium. Values for transport are normalised for 5 l/min flowrate.

#	Reactor T K	Ru released mg	Bubbler mg	Filter mg	Release rate mg/min	Transport: gaseous mg/min	Transport: aerosol mg/min
1	1300	88,5	4,80	0,6	Exp	0,1723	0,0208
2	1700	777,0	0,16	> 123,3	19,43	0,0054	> 4,1768
3	1700		4,53	4,84		0,0126	0,0134
4	1500	223,9	1,01	15,3	9,73	0,0524	0,7944
5	1100	40,3	~ 0	0,26	0,11	~ 0	0,0007
6	1500	247,5	0,05	52,0	6,04	0,0012	1,2677
7	1300	36,8	1,40	2,0	0,82	0,0311	0,0444
8	1300	37,5	0,82	0,5	0,83	0,0182	0,0111
9	1300	45,0	2,33	2,9	1,00	0,0517	0,0650
10	1700	382,5	0,10	98,0	9,56	0,0025	2,4500
11	1700		1,10	0,6		0,0058	0,0032
12	1500	296,3	~ 0,15	37,6	6,44	0,0033	0,8174
13	1500		0,17	0,33		0,0009	0,0017

Ruthenium release rate results are graphically presented in Figure 121. Release rates at dry conditions at 1500 and 1700 K temperature were measured in an earlier study [1]. According to results, the release rate of ruthenium decreases while the oxygen partial pressure is decreased – as expected. Increasing steam partial pressure while keeping the oxygen partial pressure constant seemed to have no effect on release rate. Ruthenium release rate increased from 0,11 to 19,43 mg/min as temperature increased from 1100 K to 1700 K. This indicates that *significant* oxidation of RuO₂ takes place at temperatures above 1100 K. Higher gas flow rate at 1500 K seemed to also increase ruthenium release rate.

The rate of gaseous RuO₄ transported into trapping bubbler is presented as mass flow rate of ruthenium in Figure 121. Transport rates at dry conditions at the temperature of 1500 and 1700 K were measured in an earlier study [1]. RuO₄ transport rate ranged from ~ 0 to 0,17 mg/min. The lowest transport rate of gaseous ruthenium was measured at 1100 K. Transport was highest at 1300 K although release rate continued to increase as the temperature of the furnace was increased. High oxygen partial pressure seemed to favour RuO₄ transport. Also higher flow rate increased transport of gaseous ruthenium. It also seemed that increasing the amount of water vapour in a gas flow increased the fraction of transported RuO₄ compared with total amount of transported ruthenium. During revaporisation experiments the transport rate ranged from 0,0009 to 0,0126 mg/min while oxygen volume fraction increased from 6 to 19% and temperature increased from 1500 to 1700 K. The fraction of revaporised ruthenium that transported as RuO₄ ranged from 35% to 65%. It should be noted that even though the furnace was set to 1500 or 1700 K in those experiments, the oxidation of ruthenium deposits must have taken place at a significantly lower temperature

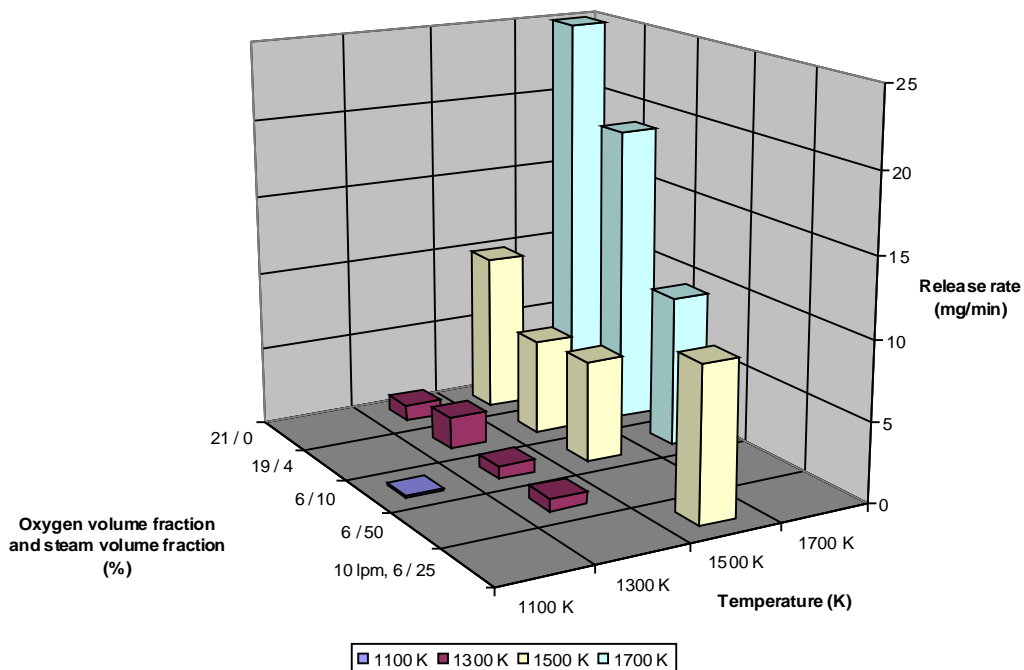

Figure 121. Ruthenium release rate (mg/min). Other axis are temperature (K) and oxygen volume fraction and steam volume fraction (%) in carrier gas flow. There is one experiment with 10 lpm flow rate.

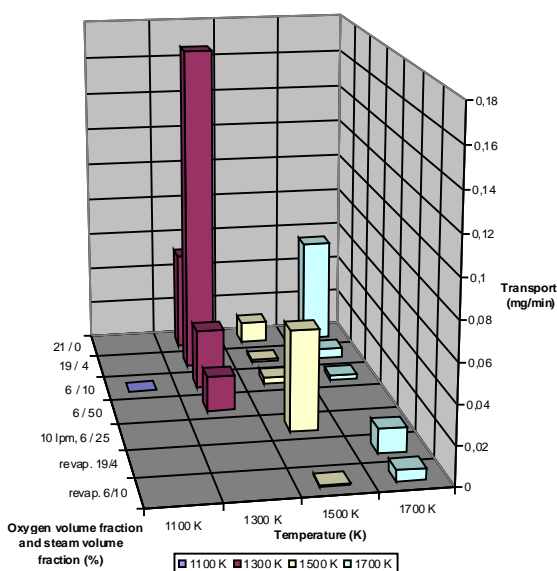

Figure 122. RuO₄ transport rate (mg/min). Other axis are temperature (K), oxygen volume fraction and steam volume fraction (%). The transport rates are also presented for experiments with 10 l/min flow rate and revaporisation.

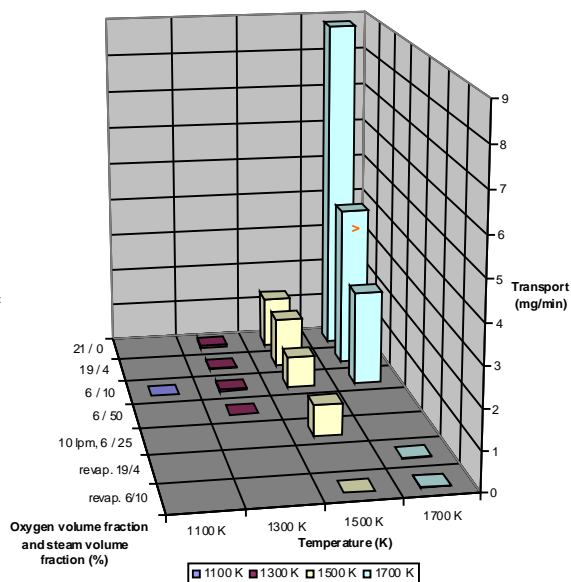

Figure 123. RuO₂ transport rate (mg/min). Other axis are temperature (K), oxygen volume fraction and steam volume fraction (%). The transport rates are also presented for experiments with 10 l/min flow rate and revaporisation.

The rate of RuO₂ aerosol particles transported into plane filter is graphically presented in Figure 122 as mass flow rate of ruthenium. Transport rates at dry conditions at 1500 and 1700 K temperature were measured in an earlier study [1]. RuO₂ transport rate in the figure ranged from ~ 0 to 8,8 mg/min at temperatures 1100 to 1700 K. Transport is increasing while temperature is increasing. As in previous experiments [1] the transport of RuO₂ particles competed with the deposition on the wall surfaces. As the temperature of the furnace increased also the cooling rate increased. Fast cooling rate favours RuO₂ particle formation in the gas phase and decreases deposition on the walls. In all experiments most of the released ruthenium still deposited on the surfaces. When the oxygen partial pressure is lower RuO₂ transport is also decreasing, because the release rate of ruthenium decreases.

The deposition profile of RuO₂ particles was measured in some experiments using a γ -tracer (¹⁰³Ru-isotope). The measured deposition profiles of ruthenium (RuO₂ mass found per centimetre) in the tube are presented in the Figure 124. Furnace outlet is located at 0 cm in the figure. As can be seen, the measured profiles correspond very well to each others. At first, it is important to note that there is no ruthenium deposition at the sample location or directly after it. The first deposition peak takes place inside the ceramic furnace tube close to the outlet of furnace (peak is about at -8 cm). At that location there is a significant temperature gradient inside the furnace because of insulation. Deposition likely takes place by thermal dissociation of RuO₃ to RuO₂. The second deposition peak is at furnace outlet and it is formed by thermophoresis. The last peak is very clear in experiments 6 and 9 (at ca. 35 cm in the Figure 124), where the gas flow was dry or the steam fraction was very low. The peak was probably due to decomposition of RuO₄ at 150–200°C. More gaseous ruthenium was transported both in experiments 7 and 8 with rather high steam volume fraction. In those experiments the third peak is absent. Decomposition of gaseous RuO₄ at a relatively low temperature is studied further in the on going experiments.

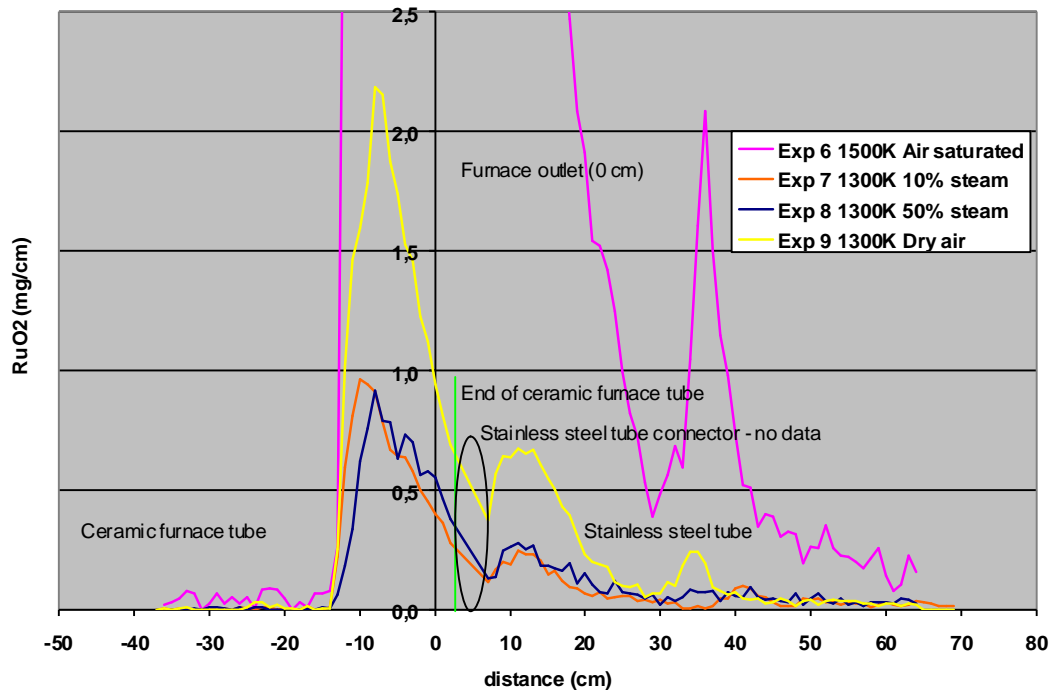

Figure 124. Ruthenium deposition profile in the experiments 6, 7, 8 and 9. Deposition is presented as RuO_2 mass found per centimetre. Furnace outlet is located at 0 cm. There is no deposition data from the flange connecting the stainless steel tube to the furnace tube.

RuO_2 particles were collected with the electrostatic precipitator (ESP) and analysed with the transmission electron microscope (TEM). Representative TEM image of particles is presented in Figure 125 with selected area diffraction (SAD) pattern of a single RuO_2 crystal.

The number size distribution of the particles was measured using a DMA-CNC combination. The typical mean agglomerate size was 108 nm and the geometric standard deviation was 1,5. The measured number size distribution corresponds to the size of agglomerates and is therefore larger than the size of primary particles.

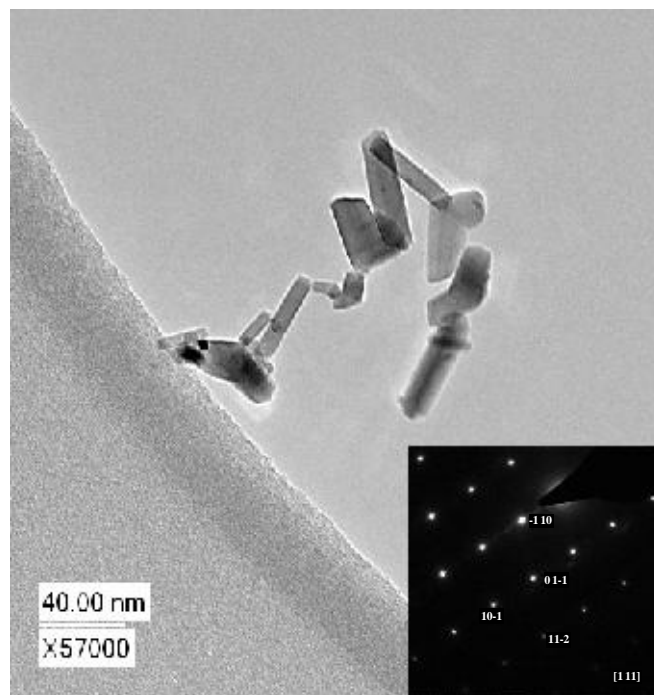

Figure 125. Representative TEM image of RuO_2 particles with SAD pattern of a single RuO_2 crystal.

Conclusions

This project is a continuation of ruthenium transport and speciation experiments conducted previously at VTT. In previous experiments it was found out that gaseous ruthenium mostly decomposed on steel surface at dry atmosphere. Those experiments also indicated that humid atmosphere may favour gaseous ruthenium transport.

At the time of the writing, thirteen experiments on the behaviour of ruthenium in humid oxidising conditions have been carried out. The transport rate of gaseous ruthenium depended significantly on reactor temperature. The fraction of ruthenium transported as gaseous RuO_4 ranged from ~ 0 to 8,8%, the highest transport rate of gaseous RuO_4 was observed at furnace temperature of 1300 K. It also seemed that water vapour in a gas flow increased the fraction of transported RuO_4 . Otherwise, when the oxygen volume fraction of the gas flow, oxidation temperature or the gas flow rate increased the transport of the gaseous RuO_4 increased. It was found out also that revaporisation of deposited ruthenium particles could be an important source of gaseous RuO_4 .

Most of the ruthenium released in the experiments deposited on tube surfaces as rod-shaped RuO_2 particles. Of the released ruthenium ~ 1 to 26% transported through the experimental facility as RuO_2 aerosol. Transport of RuO_2 increased with the oxidation temperature as well as with the oxygen volume fraction increased.

Four radioactive tracer experiments were conducted, in which ruthenium deposition profiles could be measured. These experiments showed that the most important retention mechanism was decomposition of gaseous RuO_3 into RuO_2 as the temperature of the furnace was decreasing. In these experiments the transport rate of gaseous ruthenium was decreasing while the release rate was constant. It was also found out that in experiments, in which a deposition peak was formed in the stainless steel tube, the transport rate of gaseous ruthenium was substantially decreased. Therefore the transport of gaseous RuO_4 in stainless steel tube is further studied in the remaining experiments.

References

Backman, U. Ruthenium behaviour in severe nuclear accident conditions – Final Report. VTT Processes, PRO3/P26/04, 2004.

18. Development of aerosol models for NPP applications (AMY)

Tomi Routamo
Fortum Nuclear Services Ltd

Abstract

AMY-project concentrated on understanding and modelling on deposition-resuspension phenomena of aerosols in pipe flows. The aim was to develop a calculation model that could resolve the current deficiencies in the aerosol deposition modelling in turbulent flows, and to implement the models into the tools that are used for calculating the fission product behaviour and release in severe reactor accidents. These tools are APROS SA, which is used for simulating the severe accident phenomena and progression of the accident, and SaTu (support system for radiation experts), which is originally designed to estimate radiation levels and radioactive releases during the accident situation. Based on the experimental results, the primary side deposition in the steam generator tubes during primary-to-secondary leakages seems to be rather low.

In addition to the deposition-resuspension model, other important models were implemented in the tools mentioned above. Re vaporisation of deposited fission products from primary circuit surfaces may increase the releases into the reactor containment and further into the environment, and thus the phenomenon should be taken into account. To the SaTu system, models for estimating the environmental consequences was implemented, as well, and the system was modified to be able to describe nuclear power plants other than the Loviisa plant. Another important feature for source term calculations in PSA level 2 analyses was the implementation of the uncertainty calculation environment in SaTu.

Introduction

The most important radionuclides that are released during a severe reactor accident are transported in reactor circuit mostly as aerosols. The deposition of these fission products in the pipe systems, especially in containment bypass sequences when the release route goes through narrow pipes, plays an important role in reducing the environmental releases from a nuclear power plant. The deposition in a pipe system is a complex phenomenon including the removal of deposited material either by revaporisation or by resuspension.

The aim of this work was to reduce the uncertainties in aerosol behaviour in pipe systems, and to build a model for resuspension to be used in nuclear reactor applications. The new model, in addition to other related models, was to be

implemented in codes used for modelling the behaviour of fission products during a course of a severe reactor accident.

AMY project consisted of three separate tasks: Bypass sequences, APROS SA and SaTu. In bypass sequences, aerosol deposition in bypass route piping was studied. To complement the experimental data on relevant phenomena some experiments are carried out. Based on experimental data a model for deposition-resuspension in flow condition relevant to the bypass sequences is developed. With APROS SA the aim is to complement the deposition models and validate the fission product models implemented in the code. The SaTu system includes deposition models for auxiliary system pipes, which are revised within the project. A calculation environment is developed to study uncertainties in source term evaluation in PSA 2, and a model to estimate environmental consequences is implemented in the system. In addition, the system will be modified to be applied for a NPP other than Loviisa.

Some of the results were already presented in the SAFIR Interim Report [1], and therefore they are not repeated here.

Bypass sequences

The pre-existing knowledge on aerosol resuspension in pipe flows was first gathered in a literature review [2]. This information was used to make a suggestion on the resuspension model and to plan the experimental matrix.

The aerosol deposition is studied in Horizon facility (see Figure 126), which consist of a test section of a horizontal steam generator model originally from the PACTEL facility and additional aerosol generation and measurement devices as well as steam supply equipment, and with PSAero facility that is a single tube facility with more flexible parameter variation possibilities than Horizon. Both of these two facilities had already been used in the SGTR project within the EURATOM's 5th Framework Programme [3], but the PSAero facility was extensively modified to suit better the experiments planned to be carried out in the AMY project, and eventually the aerosol deposition layer thickness profile was determined by measuring light intensity decrease through the layer.

Horizon facility has the average tube length of 8.78 m and tube diameter of 16×1.5 mm, which correspond well to the real Steam Generator (SG) dimensions in the Loviisa NPP. Two experiments with Horizon were carried out in the AMY project [4, 5] to complement the data from earlier experiments. The deposition profiles are about what was expected, but the total deposited fraction was very small in each of these experiments. The deposition models show almost total loss of the aerosols within the tube, but due to resuspension only small fraction of the material permanently remained in the tube [6].



Figure 126. The test section of the Horizon facility (originally one of the steam generators from the PACTEL facility).

The earlier experiments with PSAero showed that at a constant flow velocity the deposited material reached an equilibrium state. Resuspension was enhanced with an increasing flow velocity, and above a certain flow velocity all of the deposits were removed from the tube surfaces. The resuspension model that was developed in the project includes information on the deposition history with deposition velocity, maximum flow velocity during the formation of the deposits and some information on the adhesive forces of the deposit layer [7, 8]. An example of the model results compared against the measurements is shown in Figure 127.

In addition to the pipe deposition experiments, deposition at the entrance of a perforated plate was studied. The aerosol deposition was considered to be able to form blockages at narrow orifices in the flow path, and thus decrease the flow through pipings that could be considered in bypass sequences resulting in smaller fraction of aerosols to be directed in the bypass route.

To study this phenomenon, CsI and CsOH aerosols were injected through a perforated plate at high flow velocities [9], and the pressure was measured at the outlet side of the plate. The gas was ejected from the outlet by a vacuum pump, and thus the decrease in the pressure level showed clogging of the plate holes. It was observed that addition of CsOH into the aerosol material resulted in formations of looser deposits and clogging was not as efficient as with pure CsI particles.

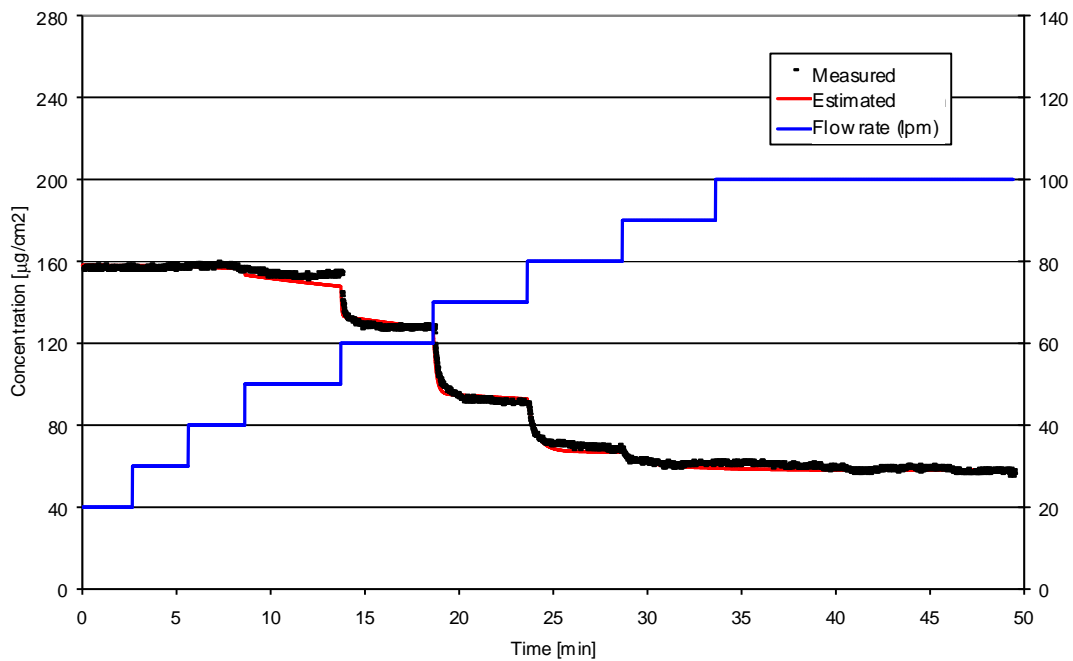

Figure 127. Example of the resuspension measurement and the modelling results of a PSAero experiment. The steps show that deposition is removed from the tube surface by resuspension when increasing the flow velocity, but stabilised rapidly to a new equilibrium state. [8]

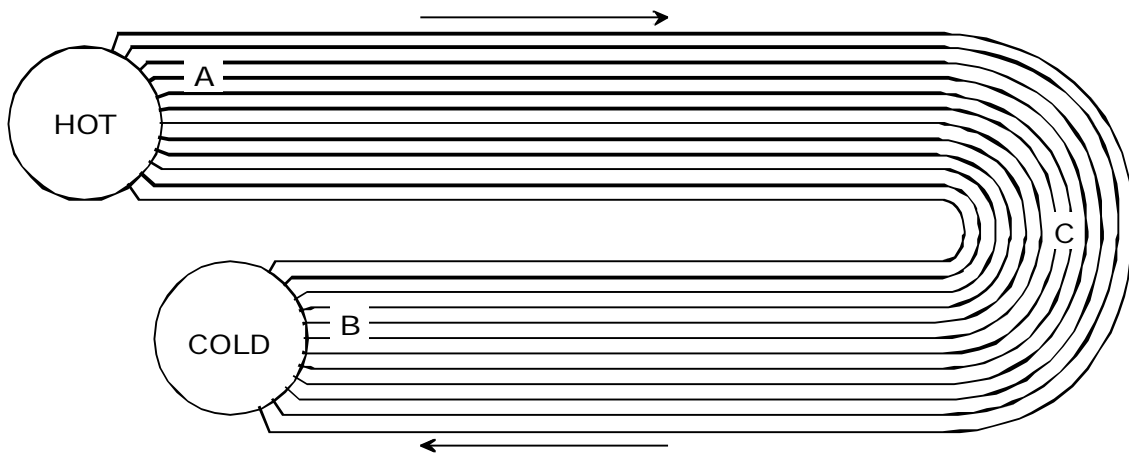

Figure 128. The leak location studied: A – close to the hot collector; B – close to the cold collector; C – half-way between the hot and cold collectors. [10]

Based especially on the Horizon experiments, a simplified model to estimate aerosol deposition within the steam generator tubes was developed [10]. The model takes into account the simultaneous deposition and resuspension by decreasing the deposition velocity from that estimated for turbulent impaction. The model was used for estimating the leak location (see Figure 128), the primary circuit conditions and the aerosol particle

size on the overall deposition. From the results for different situations in Table 21, it can be concluded that in the primary-to-secondary leakages, the deposition in the primary side surfaces of the tubes does not significantly affect the environmental releases.

Table 21. Fraction of particles flowing through the SG in different leakage conditions for CsI with different MMDs and GSD of 2. [10]

- SGTR_{xy}* – Steam generator tube rupture, *x* defect tubes, leak location *y*;
SGCB – Steam generator collector break (at the cold collector);
CLL_{zz} – Cold leg leakage, pressure level *zz* bar.

Case	MMD (µm)				
	0,25	0,50	1,00	2,00	4,00
SGTR1A	0,895	0,847	0,823	0,816	0,815
SGTR2A	0,912	0,861	0,830	0,820	0,818
SGTR5A	0,935	0,881	0,838	0,819	0,815
SGTR1B	0,779	0,522	0,246	0,087	0,040
SGTR2B	0,839	0,623	0,344	0,137	0,052
SGTR5B	0,910	0,763	0,515	0,255	0,094
SGTR1C	0,582	0,367	0,262	0,233	0,226
SGTR2C	0,567	0,376	0,278	0,240	0,229
SGTR5C	0,652	0,451	0,325	0,260	0,233
SGCB	0,995	0,982	0,936	0,807	0,558
CLL05	0,814	0,571	0,278	0,081	0,013
CLL10	0,702	0,416	0,158	0,034	0,004
CLL20	0,556	0,265	0,075	0,011	0,001

APROS SA

APROS SA includes fission product transport and deposition models, and the work in AMY project aims at validating the models implemented in the code by separate tasks for primary circuit and containment calculation. Additional models to calculate sedimentation in the primary circuit and the revaporisation from deposits were implemented in the code. However the difficulties in resuspension experiments caused delay in the model development, and therefore it was not possible to implement the resuspension model in APROS SA within the project.

The aerosol behaviour in the primary circuit has been compared with experimental results from primary circuit model in PHEBUS FPT1 experiment. Revaporisation plays an essential role in the hot leg, and all of the iodine is revaporised from the hot leg surfaces in the calculation, whereas little iodine remained in the hot leg in the experiment.

Sedimentation has also some effect on the results, since the flow velocities are rather low. The results from cesium are more or less similar with those of iodine. [11]

The aerosol models in the containment were validated towards experiments carried out with the VICTORIA facility [12, 13]. The calculations with APROS SA showed reasonable results (Figure 129 & Figure 130), although the simplified three-group model of the aerosols is not possible to describe the aerosol behaviour in the experiments completely [14, 15].

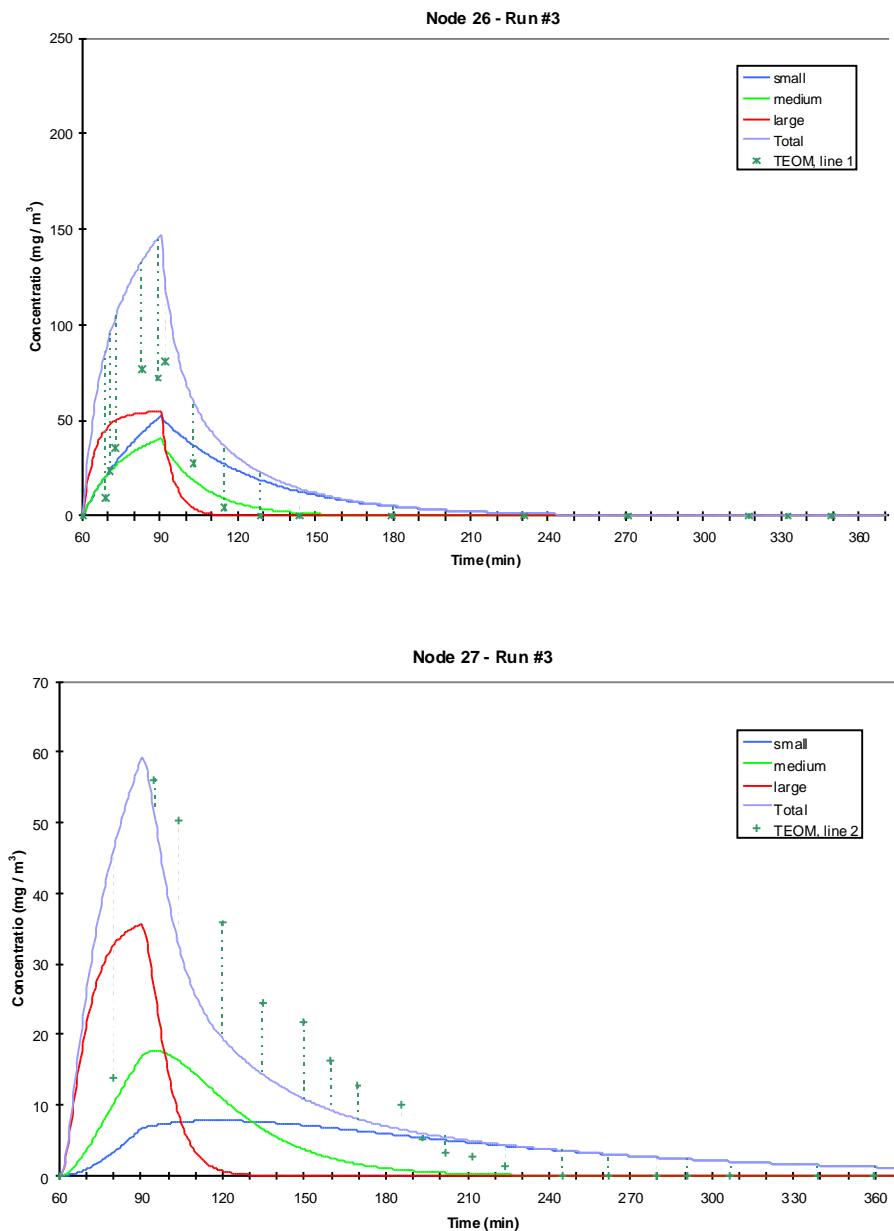

Figure 129. Measured and calculated airborne aerosol (CsOH) concentration in experiment VICTORIA-61 [14].

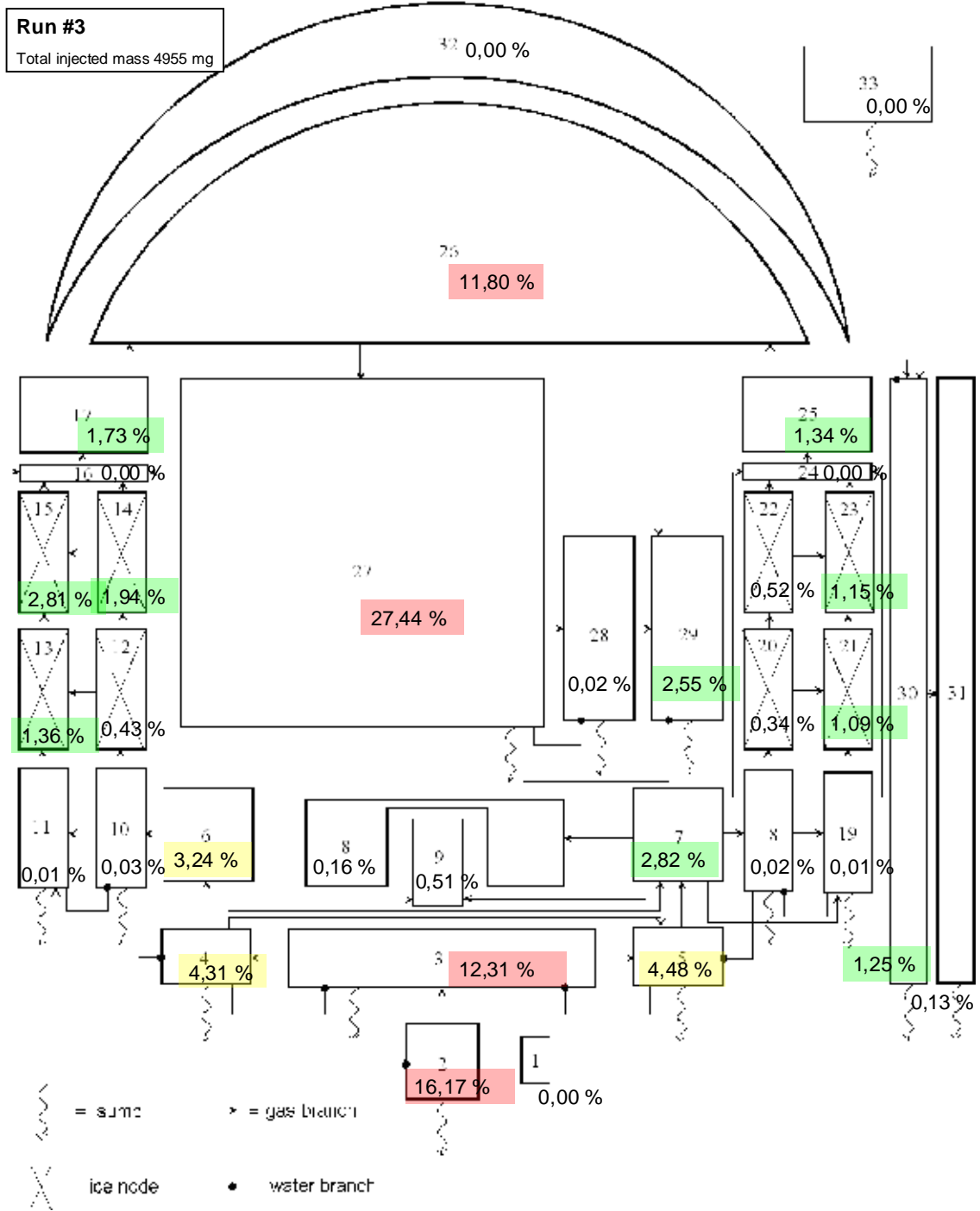

Figure 130. Calculated distribution of aerosol material at the end of experiment VICTORIA-61 [14].

SaTu

In order to evaluate radiation levels at the plant and releases of radionuclides during an accident situation at the Loviisa plant a support system SaTu has been developed as a Microsoft Excel application [16, 17, 18, 19, 20]. The system has been modified to

support release calculations in the PSA level 2 evaluation. In order to estimate environmental consequences, a model for radioactive releases in the environment was included in the system [21]. In PSA studies, the effect of uncertainties on the results should be estimated, as well. To achieve this requirement, an uncertainty calculation environment was built for the SaTu system [22, 23]. Furthermore, a version of the SaTu system was developed to roughly describe the EPR plant [24].

Conclusions

The development of a new deposition-resuspension model enhances the aerosol behaviour when considering pipe deposition. Based on the experimental data, the primary side deposition in the steam generator tubes during primary-to-secondary leakages seems to be rather low.

The added models for APROS SA allow better estimation on the fission product behaviour in severe accident calculations. However, the testing of the resuspension model still remains to be done in plant applications. The validation of fission product models in APROS SA makes it possible to carry out realistic simulations.

The environmental dose calculation tool and the uncertainty calculation environment in the SaTu system helps in estimating the quality of the results when using SaTu for PSA level 2 source term analyses. Also, it was shown that it is possible to develop SaTu system to describe the behaviour of other plants than the Loviisa NPP with moderate modifications.

References

1. Routamo, T. Development of aerosol models for NPP applications (AMY). SAFIR, The Finnish Research Programme on Nuclear Power Plant Safety 2003–2006, Interim Report, VTT Tiedotteita – Research Notes 2272, VTT Processes, Espoo, Finland (2004). 280 p. + app. 59 p. ISBN 951-38-6515-0; 951-38-6516-9. <http://virtual.vtt.fi/inf/pdf/tiedotteet/2004/T2272.pdf>.
2. Auvinen, A. & Jokiniemi, J. Aerosolimallien kehittäminen ydinvoimalaitos-sovelluksiin – Hiukkasdeposition käyttäytyminen turbulentissa virtauksessa. VTT Prosessit, Espoo 17.12.2003. Projektiraportti PRO3/P71/03. (In Finnish).
3. Jokiniemi, J., Lähde, A., Auvinen, A., Tuomisto, H., Routamo, T., Lundström, P., Dienstbier, J., Güntay, S., Suckow, D., Dehbi, A., Sloodman, M., Herranz, L., Peyres, V. & Polo, J. Steam Generator Tube Rupture Scenarios (SGTR). FISA-2003 / EU Research in Reactor Safety, 10–13 November 2003, EC Luxembourg.

4. Mäkynen, J., Jokiniemi, J. & Routamo, T. HORIZON 1 tube experiment with CsOH and CsI as aerosol material. VTT Processes, Espoo 8.5.2003. Research Report no. PRO3/895/03.
5. Mäkynen, J., Jokiniemi, J. & Routamo, T. HORIZON 1 tube experiment with varying flow rate. VTT Processes, Espoo 18.8.2003. Research Report no. PRO3/1073/03.
6. Routamo, T., Jokiniemi, J. & Mäkynen, J. Aerosol Deposition in Horizontal Steam Generator Tubes in Severe Accident Conditions. Proceedings of NURETH-10. The Tenth International Topical Meeting on Nuclear Reactor Thermal Hydraulics, October 5–11, 2003, Seoul, Korea.
7. Auvinen, A. & Jokiniemi, J. K. Modelling resuspension of particle layer in an internal tube flow. Presented in the European Aerosol Conference (EAC04), September 6–10, 2004, Budapest, Hungary.
8. Auvinen, A. & Jokiniemi, J. Aerosolimallien kehittäminen ydinvoimalaitos-sovelluksiin – Pienhiukkasten resuspensio turbulentissa kaasuvirtauksessa. VTT Prosessit, 26.8.2005. PRO3/P3033/05. (In Finnish).
9. Hokkinen, J. Deposition experiments with CsI and CsOH. VTT Processes, Espoo, September 26, 2003. Research Report no. PRO3/P56/03.
10. Routamo, T., Auvinen, A. & Jokiniemi, J. Aerosol Deposition in a Horizontal VVER-440 Steam Generator. Proceedings of ICAPP '05, Seoul, Korea, May 15–19, 2005. Paper 5243.
11. Karttunen, V. Validation of a fission product revaporization model. Helsinki University of Technology, Master's thesis, Espoo, January 10, 2005. 81 p. + apps.
12. Mäkynen, J., Jokiniemi, J. K., Kauppinen, E. I. & Routamo, T. LWR containment aerosol experiments at the VICTORIA facility. Data report – Experiments 60 and 61. VTT Energy, March 1999. Technical Report 1/99.
13. Mäkynen, J., Jokiniemi, J. K., Kauppinen, E. I. & Routamo, T. LWR containment aerosol experiments at the VICTORIA facility. Data report – Experiment 62. VTT Energy, June 1999. Technical Report 2/99.
14. Karttunen, V. APROS SA fission product validation in containment nodes with CsOH. Fortum Nuclear Services Ltd, Report 24.1.2005. TERMO-435.

15. Karttunen, V. APROS SA fission product validation in containment nodes with Ag. Fortum Nuclear Services Ltd, Report 25.4.2005. TERMO-466.
16. Routamo, T. Support system for radiation experts – SaTu, Model description V2.09.0. Fortum Nuclear Services Oy, 31.5.2005. NUCL-128 M3. (In Finnish).
17. Routamo, T. Support system for radiation experts – SaTu, User’s Guide V2.09.0. Fortum Nuclear Services Oy, 31.5.2005. NUCL-607 M3. (In Finnish).
18. Routamo, T. Support system for radiation experts – SaTu, Developer’s Guide V2.09.0. Fortum Nuclear Services Oy, 31.5.2005. NUCL-610 M3. (In Finnish).
19. Routamo, T. Support system for radiation experts – SaTu, User’s Guide for PSA mode V2.09.0. Fortum Nuclear Services Oy, 31.5.2005. NUCL-674 M3. (In Finnish).
20. Routamo, T., Eurajoki, T. & Lundström, P. SaTu- Support System for Radiation Experts. OECD/CSNI SAM Workshop on Operator Training and Instrumentation Capabilities, Lyon, France, 12–14 March 2001.
21. Lamminmäki, H. SaTu-järjestelmän ympäristöannosten laskenta. Fortum Nuclear Services Oy, Raportti 20.1.2005, NUCL-2711. (In Finnish).
22. Siltanen, S. Influence of Uncertainty of Calculation Parameters in Modelling on Radioactive Releases in Severe Accident Conditions. Helsinki University of Technology, Master’s Thesis, 2 December 2003. 93 p. + app. (In Finnish).
23. Routamo, T., Siltanen, S. & Lundström, P. PSA Level 2 Source Term Approach in the Loviisa NPP. Presented in OECD/CSNI International Workshop on Level 2 PSA and Severe Accident Management. Cologne, Germany, 29–31 March 2004.
24. Routamo, T. Support system for radiation experts – SaTu, System developed for EPR – V2.09.0-EPR. Fortum Nuclear Services Oy, 27.6.2005. NUCL 2877. (In Finnish, Restricted)

19. Emergency preparedness supporting studies (OTUS)

19.1 OTUS summary report

Jukka Rossi
VTT

Main objectives

The objective of the OTUS project was to improve emergency preparedness at the Finnish nuclear power plants with two specific tasks. The first is studying radiation levels in rooms and in the vicinity of the power plants and accessibility of them in case of a severe accident during maintenance and refuelling outage when radioactive substances can be transported into different parts of a nuclear power plant and its environment, because the lid of a reactor pressure vessel and different material transfer gates of a reactor containment building may be open. The second task was studying the effect of sea breeze on the dispersion of atmospheric discharges of the power plants during an accident and methods to assess the dispersion during such a specific weather condition.

Main results

In the first task the PSA2 analyses done for the refuelling and maintenance outage of the Olkiluoto nuclear power plant served as a starting point. Primary importance was to get insight of the maximum radiation dose rate levels at the site (Figure 131) and further to assess possible accessibility of working areas. First the accident sequence was selected and the released activities into the power plant and its environment were calculated. Then radiation levels as well as working times could be estimated based on the existing computer codes and other simplified methods. Main interest was to concentrate on the accident sequences, which are essential from a point of radiation doses. Source data was provided by STUK. A report was written comprising the methods used to define accident case, calculations done, results obtained and conclusions drawn on the accessibility of the rooms and the site during maximum prevailing radiation dose rates in the case of a severe reactor accident occurring during refuelling outage [1].

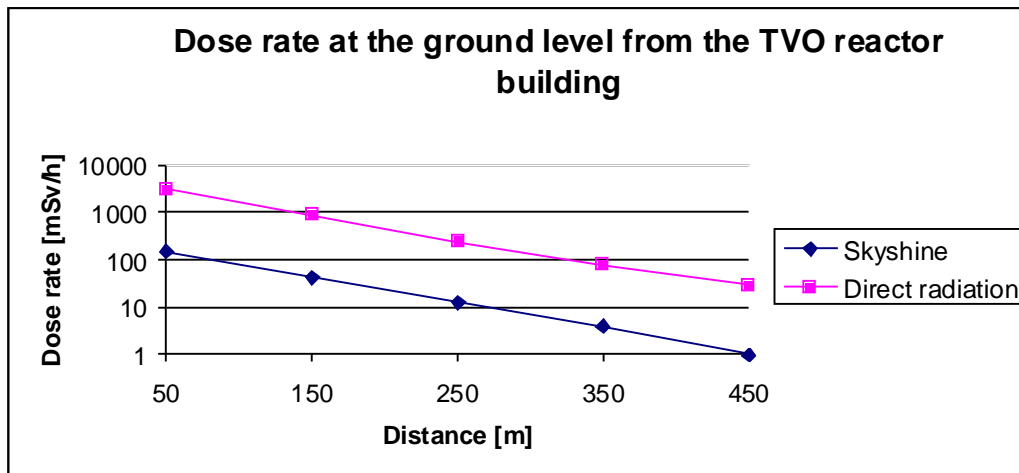

Figure 131. Maximum dose rates outdoors due to a severe accident during service and refuelling outage. Coolant has escaped from the reactor vessel and fuel has melt, consequently discharges are released to the reactor building from open reactor vessel.

In the second task the effect of sea breeze on the dispersion of atmospheric discharges and especially at the Loviisa and Olkiluoto power plants were reviewed based on the published literature. Methods to take this phenomenon into account in emergency response procedures and corresponding dispersion models on the basis of available meteorological data were investigated. The results were summarized in a state-of-the-art report consisting of the concept of the sea breeze as a phenomenon, especially focusing on the Finnish conditions, modelling features and proposals to take the phenomenon into account in the emergency response activities [2].

References

Puska, E. K. SAFIR, The Finnish Research Programme on Nuclear Power Plant Safety, Annual report 2003. Espoo: VTT Processes Project Report PRO1/P7001/04. 57 p. + app.

1. Rossi, J. Säteilyseläskelmia suojarakennuksen ohittavassa onnettomuudessa huolto-seisokin aikana Olkiluodon voimalaitoksella. Espoo: VTT Prosessit Projektiraportti PRO1/P7022/03. 14 p.
2. Rossi, J. Maa- ja merituuli ydinvoimalaitoksen onnettomuustilanteessa. Espoo: VTT Prosessit Projektiraportti PRO1/P7021/03. 17 p.

20. Interaction approach to development of control rooms (IDEC)

20.1 Integrated validation of complex human-technology systems – development of a new method

Leena Norros & Paula Savioja
VTT

Abstract

In this paper the development of a human factors engineering evaluation method is described. The method is called Contextual Assessment of Systems Usability (CASU). It is designed for performance-based integrated validation of complex system interfaces. The paper describes the design rationale of the method and the process of its development. It also makes explicit the structure of inferences that results in evaluations concerning systems usability. The major evaluation dimensions are facilitation of the core task and support for the three main functions of tools in the control of the process, the instrumental, psychological and communicative functions.

Introduction

This study anticipated the needs for knowledge, methods and know-how concerning human factors engineering (HFE) evaluation that the modernisation of the Finnish nuclear power plants and their control rooms would bring. Meanwhile the evaluation needs have become even more pressing as the Finnish nuclear programme has proceeded into the construction of a new nuclear installation with digitalised automation system and a screen-based control room. The foundations for taking the challenge of getting qualified in an extended and complex HFE evaluation activity had been laid in earlier own research that had focused on control room operators' decision making and team work [see summary in 1], and also on an earlier control room system validation [2].

The study concerns the interaction of the human operators with complex technological processes, for the control of which operators are responsible. There are several features that characterise complex processes as activity or work environments. Kim Vicente presents a list that consists of system characteristics, which increase the demands laid on both the system users and the system designers. The characteristics are for example: enormous number of relevant factors that the designer of the system must consider, heterogeneous user roles, geographical distribution and users in different locations,

dynamic nature of the system and a high degree of potential hazards in operations, many couplings and highly automated subsystems, unanticipated events and disturbances [3]. Norros has summarised this and corresponding other descriptions of complex processes by proposing that the intrinsic qualitatively different dimensions of constraints that characterise these environments are dynamicity, complexity, and uncertainty (DCU). Specific skill, knowledge and collaborative demands are related to these dimensions. The demands must be fulfilled for maintaining the overall objectives of the activity [1]. The constraints and demands are taken care of by accomplishing goal-oriented situation specific tasks. These are often labelled as primary tasks. For example in our target process, the nuclear power plant, operators' primary tasks are agreed to comprise of 1) monitoring, detection and situation assessment, 2) performing routine tasks, and 3) teamwork, crew coordination and collaboration [4]. These operator tasks are also defined according to the operational modes of the process and specific situations. Emergency, disturbance, planned transients, and normal operation modes are typically identified. For the design purposes it is practical to identify task demands according to these modes, but in reality the distinction between modes is much fuzzier, which actually complicates the operators work.

It is obvious that information and control technology is an inseparable element and resource in the control of DCU environments. It provides an interface between the process environment and the human operators and should support in all above mentioned primary tasks and still not overwhelm operators with too much information. Depending on the type of the control rooms and the specific monitoring and control devices the so-called secondary tasks of operators vary. Secondary tasks are those needed to handle the control system itself and to navigate within it. Modernising and digitalising the existing NPP analog control systems is currently taking place world wide. Simultaneously, screen-based presentation of information and "soft" screen based control of the process are being substituted for traditional wall panels and control desks. This change in the human-system interface is expected to leave the primary tasks intact but induce changes in the secondary tasks. It is unclear yet, how big a change is going to take place in work demands and ways of work, and what actually are the safety consequences of the change. Hence, there is a demand for adequate means to evaluate the new control rooms and interfaces. The evaluation should support both design and regulatory acceptance of new designs. In our work we articulated these two aims as two basic functions of evaluation, the innovative and the normative function, respectively.

Design rationale of the new evaluation method

As we indicated, evaluation of human-system interfaces is a widely identified demand and so is also the need for appropriate methods to do the job, i.e. to accomplish an integrated system validation. In the initiative of the US Nuclear Regulatory Commission

and the Electric Power Research Institute considerable internationally shared work has been conducted to create valid and effective approaches to integrated validation [5, 6]. Integrated validation is according to the former report an evaluation using different types of performance-based evaluations to ensure that the design is consistent with performance requirements and acceptably supports safety operation of the plant [5, p. 57]. Our work was from the very beginning considered to be part of the international effort to improve evaluation methods. Hence we informed ourselves thoroughly with the existing relevant literature [7] and created contacts with central actors in the field. In getting acquainted with the on-going work in the area we also identified open questions with regard to which we could make a novel contribution. In the following we name four issues in which we found improvements or optional solutions to be motivated.

Human performance may basically be considered from two points of view in design. Traditionally human behaviour has been perceived from the perspective of causing risk to the proper and safe functioning of the system. The other perspective emphasises the positive contribution of human performance for productivity and safety. If design only focuses on the minimising of the human contribution to risk this would sooner or later lead to putting the human operator aside the responsibility for control [8]. The fact that there are still pilots on board of commercial aircrafts even though technological prerequisites for unmanned flying are considered being available, is an example of exploiting the positive effect of human behaviour. The favourable effects and the features of artefacts that support them need to be articulated also. This is what usability-oriented human-centred design can provide. Drawing on these arguments we maintain that the rationale for evaluation of the human-system interface is not only safety but safety through usability of the technology. Hence, in our approach, we should integrate knowledge from two so far alien areas of research and design, i.e. from system and risk-oriented human factors engineering and usability-oriented human-centred design. We should be informed of both traditions when defining the evaluation dimensions for good design. The notion of “systems usability” that was adopted early in the work as the ultimate quality attribute and target of HFE, portrays our integrative and system oriented point of view to evaluation. Tools under evaluation are constituent of the system, and thus their quality has an effect on the functioning and development of the whole system [9].

Our next consideration was that the evaluation method should facilitate both functions of evaluation mentioned above, i.e. the innovative and the normative function. Articulation of these functions sensitised us of the nature of evaluation, and of the nature of the interaction between the utility and the regulator in the course of an actual design process. We first thought that utility-driven innovation would typically dominate in the beginning and regulator-driven normative acceptance in the end. This is true, but, we also found that due to the complexities and uncertainties of the design process the

two functions interrelate considerably over the whole design process and that the interaction between the interest groups is in reality much more complicated. The consequences of these reflections to the method development were that we identified time and design-process-maturity related constraints on the method. The evaluation should support systematic accumulation of knowledge and insights both with regard to design and acceptance. Hence design feedback during the sometimes very long design process (modernisation processes take about 10 years both in Olkiluoto and Loviisa NPP's) should be made available, and accumulation of evidence for acceptance collected.

A third major improvement that we were aiming at with the new method was more adequate definition of the underlying evaluation basis for good design. According to the generally agreed idea of integrated validation, operator performance is the basis for evaluation (see above). Acceptance of the human-system interface is not only made on the basis of interface features that would conform to targeted interface design guidelines. In addition to that, good design would become evident in good operator performance. The challenge arises to define what then is good performing. In this question our method should clearly add new features to any earlier one. The presently available methods typically use either process outcome indicators or human performance outcome measures like time, failures, compliancy with rules etc. Even the so-called cognitive measures [10] – the most popular of them is situation awareness (SA) [11, 12] – evaluate performance from an external outcome-oriented and situation specific perspective. On the basis of these measures generalisation over situations is very difficult. People, however, do develop generic and for them meaningful approaches, habits, to tackle the ever changing situations. The idea is that we should try to identify the quality of these habits, and use this as a basis for our evaluation. This kind of reasoning would allow generalisation and prediction. [1]. We conclude that our method should make use of the possibility to identify both situation-specific performance and generic habits as basis for integrated evaluation of human-system interfaces.

The final design rationale that we held decisive concerns the question how to connect human performance results to human-system interface features. In other words, how do we know which interface features are responsible for certain performance results, and how to make usability-informed inferences to improve design? Most of the presently available integrated validation methods do not consider this issue in a deliberate way. It is not a surprise, because – as we argued above – the measures that are used focus on the performance outcome and evaluate changes in outcome on a statistical basis. The measures do not consider how people actually use information and act, i.e. what is the process that brings about the observed outcomes. Our method should reveal this connection.

The above-described design rationales define the theoretical basis of the method. The method was labelled Contextual Assessment of Systems Usability. In the following a brief review is provided of the phases of its development. Thereafter the structure of the method is presented.

Phases and procedure in the method development

The method development comprised of both theory-based conceptualisation and empirical testing. In the theory-based conceptualisation we first made use of our own previous work. This work was set in relation to international human factors and human-centred design literature, and guidelines on human factors evaluation and usability testing. We also launched a conceptually-oriented collaboration within the OECD Halden Reactor Project. In the collaboration function-oriented design thinking was the major topic. This design philosophy relates closely with our core-task -based evaluation approach.

Empirical testing took place in two forms. The first type of testing was connected with the modernisation processes of the Finnish NPP's in Loviisa and Olkiluoto. We were able to accomplish comprehensive simulator runs with three different scenarios and six crews at both sites to determine how the operators utilise information in the control room before any changes had taken place. These runs have so far been used only for method development purposes but will in the future serve as reference if the new fully modernised control rooms should be benchmarked against the old ones.

As the modernisation proceeded we were in several ways involved with the design process. Designer interviews were accomplished in both plans to define the design rationale of the renewal. In the case of Loviisa, where the utility is directly involved with the design of the human-system interface, we also accomplished two further evaluation steps. The first one focused on the style guide to be used in the further phases of the design. The second concerned the first pilot designs that focus on restricted systems. The results of these tests verified the style guide and validated the design approach on information display level. These results are informative with regard to the design to be accomplished in the subsequent phases. The results also serve acceptance function and were delivered to the regulator.

The method could also be tested in another type of empirical context. The method was namely implemented in a more forward looking research in which we, in collaboration with the OECD Halden Project, accomplished simulator experiments to test new interface concepts within a comparative design.

In all these evaluation tasks the method was implemented. The comprehensive reference tests were particularly helpful in defining the evaluation basis and the metrics. The style guide analysis provided insights of how to incorporate usability standards and guidelines into the method. The pilot test within the on-going modernisation sensitised us of the longitudinal aspects of evaluation and the need to adapt the method to the maturity-level of the design. It also clarified the two evaluation functions, the innovative and the acceptance functions. The testing of display design concepts was helpful in clarifying the ideas concerning the actual connection between interface features and operators' performance and practices.

The basic structure of the method

In this section we shall present the logical structure of the CASU-method. First we define the bases of evaluation used in the method, i.e. demands on systems usability. Then we provide the inference structure that enables us to make evaluations of systems usability [9].

Systems usability of a complex human-system interface means, first, that the technology should be evaluated in a *holistic* and *context-dependent* way. This we achieve by claiming that the technology must *facilitate fulfilling the core task* of the particular work. We use the activity system model [13] and the functional modelling of the physical domain [3], with the aid of which we can define the users' task in a new systemic way. This is called the core task [1]. Core task is the essential content of a particular work that is determined by the constituents of the activity system and the functionalities of the physical domain. The demands of the core task must be maintained in all situations as the physical laws for their part remain the same from situation to another.

The core-task modelling provides a consistent and theoretically founded way to define the circumstances in which the artefact is used. The definition of the context is not restricted to the actual perceivable situation, as is often the case in scenario-based techniques. Instead it also enables an analysis of the invisible societal and historical content of the activity which the users may take into account according to different logics that make sense to them.

In order to reach the demands of systems usability work tools must, secondly, *fulfil three generic functions of tools, the instrumental, psychological, and communicative*. These functions are drawn from the cultural-historical theory of activity and integrated with ideas of media theory as Rückriem has proposed [14]. Thus, systems usability of tools means that tools are such that they are good instruments to induce a desired effect, they are good cognitive tools that fit and shape the human dispositions to act

appropriately, and they communicate the relevant content to the users in a meaningful visual or multimodal representation. Hence, we use *efficiency and effectiveness, fitness for human use* and *meaningfulness in use*, as evaluation dimensions.

Good systems usability is visible in the users' work performance as systems usability promotes the construction and development of work practices. Good work practices are such that they produce *good directly measurable results*, and they have internal quality features like *interpretativeness, communicativeness and orientedness to the core task*, and the users experience the technology to be *promising* for the future development of the work and its core task.

The essence of CASU method is depicted below in Figure 132. It is a simplified version of the actual model and, hence, mediates the basic content clearly. The inference process consists of four separate phases. In Figure 132 the coloured boxes denote research activities and the white boxes are the outcomes of the activity. The first phase i.e. the modelling phase outlines the basis for the evaluation by producing a reference. In here it is stated what good process control activity in a given operational situation is. The modelling phase includes task analysis, but it is called modelling, because the output is a model of the task demands defined both in functional and sequential form. It is the first approximation of the core task. The important outputs of the modelling phase are the core-task oriented measures and criteria used in the control room evaluation.

The second phase is the data collection phase in which the actual simulator runs or other performance situations are observed and the video and the interview data are collected. In the CASU methodology the data collection methods vary from observation of activity and questionnaires to a few types of interviews. Data collection can be carried out either in a simulator or in a normal work situation.

Third phase is the analysis phase. Analysis aims at taking different perspectives to the collected data. First the observation data is analysed from chronological point of view. What happened in the scenario and when, is examined. This is combined to process performance analysis. From trends and logs we can see how the process behaved and whether the main parameters remained within acceptable boundaries. In the analysis of practices, we look at the crew's practice of process control. This is done based on both the observable behaviour and the justifications the crew gives for their own actions. In interaction analysis, the human-system interaction is observed on a detailed level. The experienced appropriateness is analysed based on the interview data.

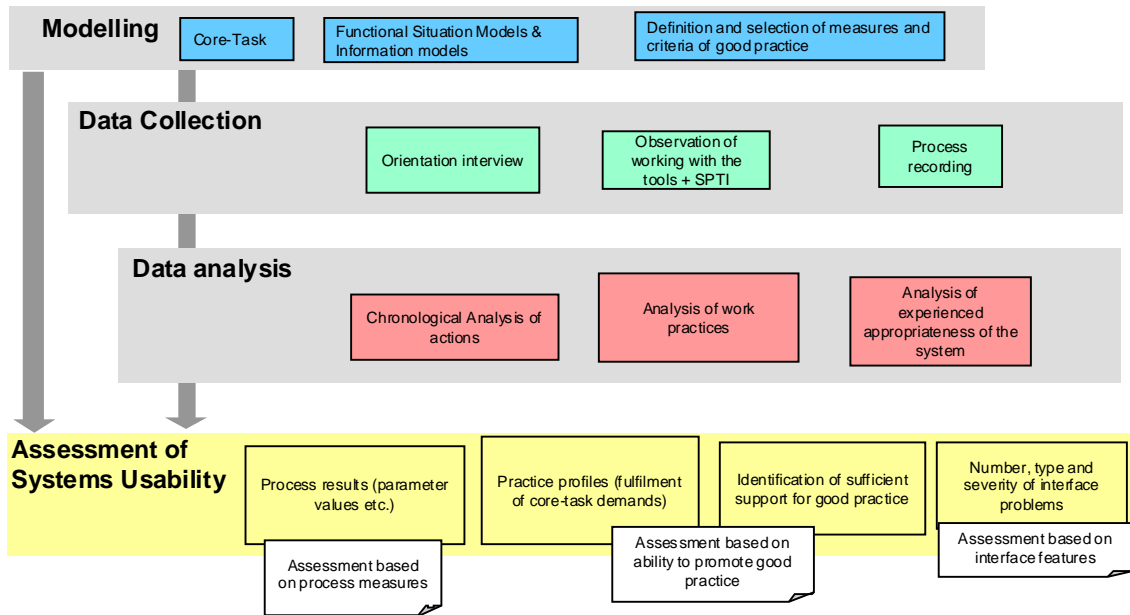

Figure 132. The principle inference structure of evaluations proposed in the CASU method. (Abbreviation SPTI refers to situational process-tracing interviews).

The evaluation ends with the assessment of the interface. The assessment is made by combining three points of view: Process measures, the tools ability to promote appropriate work practices, and interface quality.

The future use and development of the method

As we indicated the development of the CASU method was a twofold task, i.e. it included conceptual innovation and empirical testing of the method. With regard to the conceptual challenges we see that we succeeded to implement the theory-based design rationales into the structure of the method. Hence, the concept of “systems usability” that was seen to provide a comprehensive point of view to the evaluation could be decomposed to provide a basis for evaluation. The main dimensions that underlie evaluation are fulfilment of the core task and support for the three main functions of tools. Thanks to these evaluation dimensions the method deserves its specification as a contextual method.

By the second design rationale we emphasized the interaction of the two functions of evaluation, innovation and acceptance. In the method this rationale was observed by taking a longitudinal perspective to the evaluation. We discovered that a definite way to synthesise evidence for acceptance that arises from repeated and diverse reweaving, testing, hearing and other measures and sources should be made possible. Proof for safety and usability could be offered in the form of a combined safety and usability case. This type of reasoning could provide a possibility to accumulate evidence for

acceptance. Due to so far restricted possibilities to use the method in the evaluation of actual design results, the practical solutions of how to implement the second design rationale was incomplete. Plans have been made to continue work in this question. In this connection we aim also at specifying how to construct the integrative systems usability ratings to provide an indication of the acceptability and promisingness of the new technologies.

The third design rationale focused on the need for more profound understanding of user performance that is generally considered as the reference in integrated validation. The major invention in our method is to extend the performance evaluation to cover not only situation specific performance outcome measures but include also measures that reveal the generic mode of working that operators tend to repeat in all corresponding situations. Only when people become aware of their habits it is possible effectively to discuss what they as expert practitioners hold as internally good performance [15]. These, in our case operators' own evaluations, can be used as reference when evaluating the technologies and their role in shaping users performance.

The fourth design rationale pointed out the necessity to identify the connection between display features and practices. We created a semiotic i.e. communicational solution that reveals the connection between the display type, process content to which it refers, and the operator practice that provides the interpretation of the meaning of the above connection. The analysis of the triadic relationship reveals not only whether some information is delivered to the operators but also whether the information conveys relevant meaning that the operator is able to make use of in practice. With the aid of this method we may study whether the designers succeeded to communicate meaningful information of the process via their design solutions, and whether operators are distributing the meaning within the crew in a coordinated way, and so that a shared understanding of the situation is formed. This line of development of the CASU-method will continue in the still on-going work in which we compare different forms of information presentation. We have also created possibilities for even more far-reaching design-oriented work in which we, together with experts of the NPP process, semantic modelling, and virtual reality and multimodal information presentation technologies, study new ways to afford and grasp the dynamics of the process.

Conclusions

In our work we have made explicit that systems usability is a relevant qualification of the complex human-system interface and a significant part of the overall safety of the process. We also have brought up that in the questions of design, the interaction between the utilities and the regulator probably takes a form of dialogue between experts, because it is not possible to have a completely pre-defined safety and quality

reference. Rather what is held safe and good enough must be negotiated among the experts of both sides during the design process. We see that human factors should have a say in these discussions, and that the CASU-method is one way to create basis for the human factors experts to participate. We may conclude by noting that this method appears to be applicable also in other domains in which systemic analyses are needed about the human-system interfaces and their design.

References

- [1] Norros, L. Acting under Uncertainty. The Core-Task Analysis in Ecological Study of Work. VTT Publications 546. 2004, Espoo: VTT. ISBN 951-38-6410-3; 951-38-6411-1244. <http://virtual.vtt.fi/inf/pdf/publications/2004/P546.pdf>.
- [2] Norros, L. & Nuutinen, M. Performance-based usability evaluation of a safety information and alarm system. *International Journal of Human-Computer Studies* (63), 2005, pp. 328–361.
- [3] Vicente, K. J. *Cognitive Work Analysis. Toward a Safe, Productive, and Healthy Computer-Based Work*. 1999, Mahwah, NJ: Lawrence Erlbaum Publishers, (1999).
- [4] O'Hara, J., Pirus, D. & Beltracchi, L. Information display: Considerations for designing modern computer-based display systems. Electric Power Research Institute: Palo Alto, CA.
- [5] O'Hara, J. et al. Human factors engineering program review model. United States Regulatory Commission: Washington, DC.
- [6] EPRI, Human factors guidance for control room and digital human-system interface design and modification, in Report 1008122. 2004, Electric Power Research Institute.
- [7] Norros, L. & Savioja, P. Usability evaluation of complex systems. Radiation and Nuclear Safety Authority (STUK): Helsinki, Finland. p. 44.
- [8] Papin, B. Integration of human factors requirements in the design of future plants. in Enlarged Halden Programme Group Meeting. 2002. Storefjell.
- [9] Savioja, P. & Norros, L. Systems usability – promoting core-task oriented work practices. In: *Maturing Usability: Quality in Software, Interaction and Value*. Law, E. et al. (eds.). Springer. (In press).

- [10] O'hara, J. M. A quasi-experimental model of complex human-machine system validation. *Cognition, Technology & Work*. 1(1), 1999, pp. 37–46.
- [11] Endsley, M. R. Toward a theory of situation awareness in dynamic systems. *Human Factors*. 37(1995), pp. 32–64.
- [12] Endsley, M. R. Measurement of situation awareness in dynamic systems. *Human Factors*. 37(1995), pp. 65–84.
- [13] Engeström, Y. Activity theory and individual and social transformation. In: *Perspectives in Activity Theory*. Engeström, Y., Miettinen, R. & Punamäki, R.-L. (eds.). 1999, Cambridge University Press: Cambridge. Pp. 19–38.
- [14] Rückriem, G. Tool or medium? The Meaning of Information and Telecommunication technology to Human Practice. A quest for Systemic Understanding of Activity Theory. University of Helsinki, Center for Activity Theory and Developmental Work Research: <http://www.iscar.org/fi/>.
- [15] Macintyre, A. *After Virtue: Study in Moral Theory*. 2nd ed. 1984, Notre Dame, Indianana: University of Notre Dame Press, 1984.

21. Application possibilities of systematic requirements management in the improvement of nuclear safety in Finland (APSREM)

21.1 APSREM Summary Report

Veli Taskinen
RAMSE Consulting Oy

Main objectives

The main objective of the work was to map state-of-the-art Requirements Management (ReM) practices, and to study and present a summary of the practices and application possibilities in the selected application areas (Figure 133). The most important application areas were the nuclear authority (STUK) activities and the modifications and procurement of nuclear power plants.

Specific goals

- to study the Requirements Management research situation
- to study the state-of-the-art practices in Requirements Management of the selected application areas
- to study the application areas of requirements management of STUK and utilities
- to draft the Requirements Management process for FIN5 nuclear power plant case
- to identify Requirements Management standards applicable in the nuclear industry.

Main results

- The study on research in ReM indicated that ReM has been conducted mainly in software production, especially in the requirements definition phase of ReM. Short descriptions of the methods developed in the research projects have presented in the APSREM project report. [1]
- It was found that the focus of the identified ReM practices was on the definition of stakeholder requirements and on software production. Essential approaches and the most important practices concerning the ReM for authority use have been identified in the project, and their main principles have been described.

- Safety control of new and operating nuclear power plants was pointed out as application area of ReM practices for authorities and procurement of new nuclear power plants and modification of operating plants for utilities.
- A tentative ReM process has been developed for the nuclear safety control of the FIN5 nuclear power plant.
- About 30 nuclear safety standards have been analysed from the requirements management point of view. The results showed that ReM has been included in different ways and to a varying extent in the standards, and only part of them are good enough for systematic ReM.

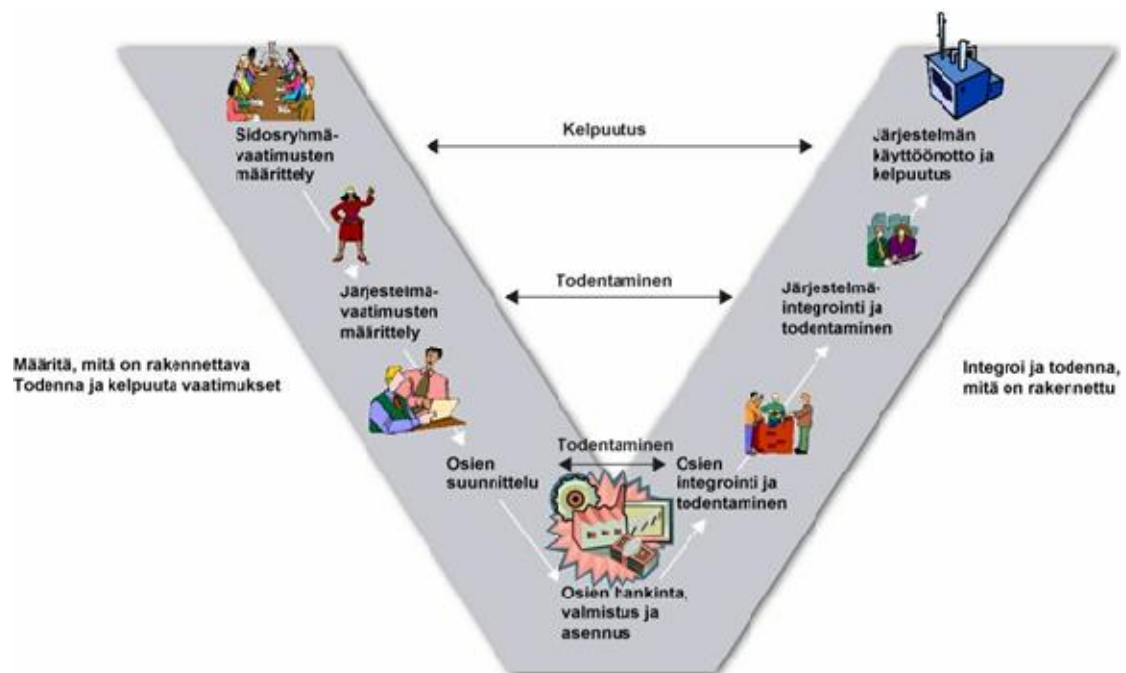

Figure 133. The APSREM project aimed at producing nuclear specific requirements management material in Finnish.

References

Puska, E. K. SAFIR, The Finnish Research Programme on Nuclear Power Plant Safety, Annual report 2003. Espoo: Technical Research Centre of Finland (VTT), 2004. 57 p. + app. (VTT Processes Project Report PRO1/P7001/04).

1. Renlund, M., Taskinen, V., Vaatimushallinnan soveltamismahdollisuudet ydin- turvallisuuden parantamisessa Suomessa. Helsinki: Säteilyturvakeskus (STUK), 2004. 54 p. (STUK-YTO-TR 203).

22. Influence of RoHS-directive to reliability of electronics – preproject (ROVEL)

22.1 ROVEL summary report

Hannu Hossi, Helge Palmén & Antti Turtola
VTT

Introduction

The target of this prestudy was to study the necessary changes in electronics due to the so called RoHS -directive (Directive 2002/95/EC of the European Parliament and of the Council, of 27 January 2003, on the restriction of the use of certain hazardous substances in electrical and electronic equipment [1]).

The directive will ban the use of lead, quicksilver, cadmium, hexavalent chromium and flame retardant materials PBB (polybrominated biphenyls) and PBDE (polybrominated diphenyl ethers) in new electronic products put to market after 1 July 2006. The needed changes in materials and processes may alter the product so much that its properties do not correspond present.

Main objectives

Modifications due to EU RoHS -directive

The changes due to the directive were studied by collecting information from Finnish and international research projects. This was done by participating to the following international conferences, the Scandinavian NoNE (No Lead in Nordic Electronics) project final conference in June in Copenhagen and IPC/JEDEC 2004 International Conference on Lead-Free Electronic Assemblies and Components in October in Frankfurt.

Participation in IEC TC45 standardisation work

The development of the new IEC-standard, IEC 62342: Nuclear power plants – Management of aging of nuclear power plant instrumentation and control and associated equipment (45A/441/NP), has continued. The work was done in the IEC TC45 working group WG A10, Instrumentation systems.

Main results

Modifications due to EU RoHS -directive

The so called RoHS-directive is going to prohibit the use of some elements in the electronic industry: lead, chromium 6+, mercury, cadmium, polybrominated biphenyls (PBB) and polybrominated biphenyl ethers (PBDE). The ban of lead is at the moment considered to be most critical to the reliability of electronics.

Lead has been used in the soldering materials because it makes the soldering operation easier. The properties of the lead containing solder joints are also better. Connection technologies of electronic components have a big influence to the reliability of electronic components and also to the end products. That is why each new material and technology requires to be studied before they can be adopted. Higher melting point of lead free materials is a very important parameter. This means a higher soldering temperature and some differences in the production. The components and the printed circuits boards (PCBs) have to tolerate higher temperatures. Also the chemicals that are used in the process have to be designed for the lead free process. The producers of soldering materials offer many alternative lead free solder alloys. The main metal in these lead free alloys is tin. The most common supplements to tin are copper and silver (the SAC-alloy).

According to the published research results a reliable solder joint can be made using lead free materials and processes. There are still some possible reliability problems. Mostly these problems are due to some unsuitable materials and chemicals that are still on the market. And some problems come purely because the process window of the lead free process is tighter than in the commonly used process at the moment. This makes the process control more demanding which can cause reliability problems.

Participation in IEC TC45 standardisation work

The development of the new IEC-standard, IEC 62342 Nuclear power plants – Management of aging of nuclear power plant instrumentation and control and associated equipment, was finished in to a committee draft [2]. The next phase will include development of detailed standards for selected components (e.g. connectors and cables).

References

1. Directive 2002/95/EC of the European Parliament and of the Council, of 27 January 2003, on the restriction of the use of certain hazardous substances in electrical and electronic equipment.
2. IEC 62342 Ed.1: Nuclear Power Plants – I&C systems important to safety – Management of aging, 1 September 2004, Committee Draft (45A/541/CD).

23. Software qualification – error types and error management in software life-cycles (QETES)

Hannu Harju & Jukka Ranta, VTT
Martti Välisuo, Fortum Nuclear Services

Abstract

QETES-project aims at giving a new approach to classify software defects. The approach is based on three aspects of computer semiotics: syntactic, semantic and pragmatic. Previously several defect classifications have been proposed in software engineering, but most of them do not focus on the defect detection and prevention. The new approach supports identifying the subset of defects to be eliminated reliably by design and testing so that qualification of safety critical software becomes more effective. The proposed computer semiotic classification of defects has been validated by a number of incidents involving software errors.

Introduction

Software qualification is one of the main challenges in implementation and renewal of instrumentation and control systems in nuclear power plants. The new plant and modernisations of previous plants will increase the use of critical software in control and protection tasks. The automation technology is changing from analogy to digital technology everywhere. The demand for software based systems will be expected to grow during the following decades.

The use of software in I&C systems brings unquestionable benefits seen as increased safety and reliability, but due to more complicated software the growing use brings also problems: difficulty of identifying defects, a risk of introducing common mode failures through the software, difficulty of proving that tools are producing correct results, and expensive verification and validation and licensing processes of software based safety systems.

Since designing and programming of software are essentially making statements in some language, it is also closely linked to linguistics theory; although, there are many research papers that connect linguistics to software or computer engineering [1, 2]. According to linguistics theory, software errors can be classified into the following error types:

- Syntactic error, which is an inconsistency between items presented in a document and the language in which the document is written.

- Semantic error, which is an inconsistency between a document and information in another document or domain.
- Pragmatic error, which is an inconsistency between a document and user's or computer's interpretation of it, or a failure to use the document.

Different error management methods prohibit various errors types. In order to be comprehensive, error management process should use several methods in prohibiting together all types of errors. In order to evaluate comprehensiveness of the error management, each management method should be evaluated in respect of every error type. The evaluation succeeds providing that error types have been defined orthogonally and completely.

We have considered the relevance of the new approach to classify software defects in two ways: we give common problems due to computer safety systems to be answered, and we validate the approach by a number of incidents due to software errors. The questions are the following: Can crash of a software process or a processor be caused by semantic errors? Can functional diversity save from semantic errors also when the diverse functions are in the same processor? Can pragmatic errors be detected by the self diagnostics? Answers to these few questions will clarify us how to design and evaluate safety of software based systems and system concepts. The validation process and results are given in its own section of this report.

Previous defect classifications

Classification of software defects² is a process of analysing and precisely categorising software defects, in order to facilitate the defect avoidance and prevention processes. The classification can be created in several ways. Our goal at QETES-project is to determine whether or not defect classification based on the three aspects of semiotics (syntactic, semantic and pragmatic) would support qualification of software.

Important principles for any classifications are orthogonality and completeness [4]. By orthogonal, we mean that the allocation of a software defect into one predefined class will only be allocated to that specific class. By completeness, we mean that all possible software defects are classified concerning the two positions of artifacts hold: across work products and across the entirety of the system. Every defect must fit into one and only one of the defined classes.

² We use definitions of fault, error and failure given by Laprie [3]. By defect, we mean any of these terms.

There are a number of different classifications that have been suggested in the literature [4, 5]. One of the several ways to categorize software defects in real time systems is to divide them into logical errors and execution (run time) faults. The former are caused by the logic described in abstract documentation (specifications and models); the latter are caused by various errors, such as divide by zero, memory leakage, segmentation fault, deadlock, etc. Another way is to categorise real time software faults into the value domain and into the time domain. Unfortunately, only a few classifications are focused on the defect detection and prevention.

The failure modes to be tolerated are expressed in terms of failure models that range from fail-stop and crash to response and arbitrary failures. In many applications the performance of computers is measured with metrics such as response time, the faster the better with no specific requirements on the timing behavior of the system. But real-time applications are different from this paradigm of computation in that they impose strict requirements on timing behavior of the system. Traditionally, the correctness of many computer systems has been taken to imply their logical and functional behavior. For real-time systems correctness depends on the temporal properties of this behavior as well.

There are various classifications for failures; according to Cristian [6] failures can be divided into the following categories:

1. Crash failures occur when a component after the first omission failure omits to respond to all subsequent inputs.
2. Omission failures occur when a component fails to respond to an input.
3. Timing failures occur when a component responds correctly, but outside the required real time; that is, either too late or too early.
4. Response failures occur when a component responds incorrectly, either with an incorrect value or an incorrect state change.

Cristian emphasizes the relations between components, and the difference between the correct and failure behavior of a component: one component depends on another if its correctness is contingent on that of the other. The interaction and communication of components have a strong effect on constructing computer semiotics.

Computer semiotics

Semiotics is the discipline of signs, e.g. symbols, signals and tokens, which are considered in all human systems [7]. In recent years, semiotics has extended for information systems [8, 9]. From the semiotic point of view, an organisation, though a small collection of computers and people, is an information system: information is created, stored and processed for communication, coordination and achieving organisational objectives.

A theoretic readiness of information semiotics is in its first steps. Some of semiotic aspects given by Stamper [9] are very well handled in computer engineering. There are effective means for computer and software engineering to deal with syntactic, physic and empiric aspects, but Stamper's aspects semantic, pragmatic and social layer are yet to receive a sound theoretical treatment. In computer semiotics there have recently been research results to clarify the theoretical bases [2, 3], but even these few activities concentrate more on human aspects than software or computer aspects. Due to objectives of QETES, concentration is only on computer system by dissipating the original cause of all software errors; the human being.

A language is defined through the use of syntactic and semantic rules to determine structure and meaning respectively. Most languages are textual like written natural languages. On engineering fields graphical languages using specific relationships between signs to present a program, specification or design are used. One of these, the function block diagram is common in control engineering. Figure 134 describes the concept of pragmatics in computer semiotics. We have two components A and B which are syntactically and semantically correct. That is, syntactically correctness means that both of these components comply with their grammars, and semantically correctness means that the behaviour of each component complies with the meaning for which the component is aimed at.

Syntax error is the most obvious type of error. That occurs when specification or code is written in a manner not allowed by the rules of the language. Notations, files and resources have this kind of potential errors, for example, a data file may be in unintelligible format. Syntax errors are reliably detected by the compiler or interpreter that presents an error message informing the problem.

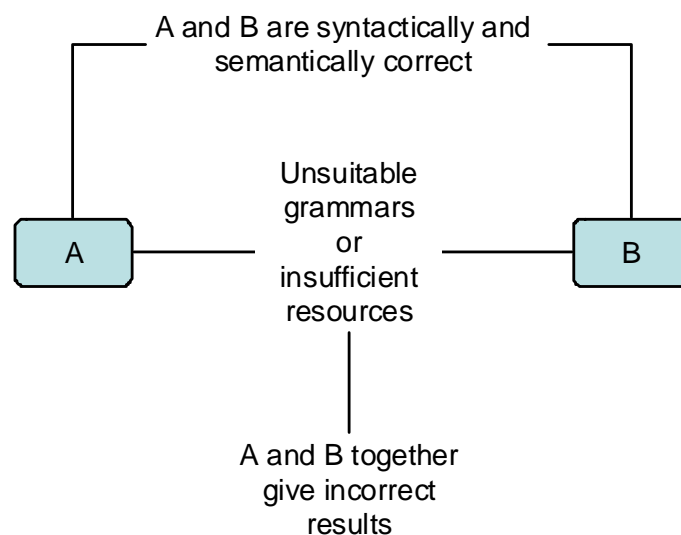

Figure 134. Pragmatic error is related to correct syntax and semantic of components.

A semantic error is more difficult to detect than the syntax one. Semantic errors occur when the syntax of specification or code is correct, but the meaning is not according to the original intention. Compilers or interpreters do not catch out all semantic errors, because the structure obeys the language rules. Most of semantic errors are caught by run time systems and by experimental means: tests and simulations. According to how to detect semantic errors, we define four types of semantic errors: 1) domain factual errors, 2) run time errors, 3) logical errors, and 4) performance errors.

Most common semantic error is domain factual error (misunderstood parameter, behaviour, event generation, or interaction protocol); e.g. incorrect parameters in inputs, states or outputs of a program. The domain factual error is external error to software; it can be detected by domain knowledge; especially important error management means are functional diversity, reviews and inspections of specifications, functional tests and simulations of the software. The domain factual error can propagate to other types of semantic errors, for example to run time errors.

Due to run time errors, execution of a program cannot be carried out. Run time errors indicate faults in the program or problems that the developers had expected but could do anything about. Run time errors are also called exceptions. For example, division by zero, $\log(-1)$, infinite loop, segmentation fault, running out of memory will often cause an exception that can be reliably caught by exception handlers in execution environment. Also electrical transients often cause run time errors in program flow, data, program codes, or processor registers. Without the intervention of exception handlers a semantic run time error will typically cause the program to crash or hang.

The third type of semantic errors, logical error, violates a combination of signs in language so that the required behavior is not implemented correctly in language. A program runs but results are incorrect. Variables may not contain the correct data, or the program may continue down a path that is not intended. These errors are called semantic errors, because while the program does not crash, the logic that it executes is in error. Logical errors can be caught by experimental means, for example testing programs verifying results against e.g. known mathematical properties.

Due to the fourth type of semantic errors, performance error, a program runs and gives correct results, but performs poorly due to bad choices in the implementation, e.g. picking a slow algorithm, not addressing elements consecutively, redundant computations, trashing, or poor parallel techniques. Performance errors are caught by experimental means, test programs and simulations performing timings on an unloaded system verifying mathematical performance models.

The situation changes as considering pragmatic errors that occur while program is running. As the Figure 134 describes, for components of the program has correct syntax and semantics, but the program runs incorrectly leading to abnormal termination of program or to crash. The cause of difficulties is in incompatible properties of the components (data type, memory size, etc.). A component A interprets wrongly another component B; if A asks a service, B cannot give it, or if B can service the request, A cannot utilize the service. Pragmatic subjects are typically things not enforced by either the compile time or run time systems, though they might be enforced e.g. by the software development environment the programmer is using.

The main source for pragmatic errors is poor information. The specifications and code should be understood by all audience groups. For a very large specification not all groups will be able to understand the whole specification. In pragmatics, we recognise that we must understand the requirements of all stakeholders in terms of responsibility, obligation, right and privilege.

Validation of the error classification approach

Validation of the approach requires comparison for a cross-section of software programs of the predicted reliability with software field-reliability. This could be a challenging effort.

A number of incidents involving software errors were studied and classified into the semiotic error types. Total of 16 cases were considered. When selecting the cases the most important factor was sufficient background information to allow reasonable knowledge about the role of software. Many accidents and incidents are reported, but few have been publicly analysed to the extent required by the classification or are presented in a suitable way. Many of the cases are related to space flight due to the mentioned reasons. Some cases have been included even though there is no detailed description of the error. In these cases it is possible that, e.g., a pragmatic error has manifested it self so that based on the description it appears to be semantic. Hence, the focus of the cases is in clarifying the concepts of classification, not actual analysis of accidents.

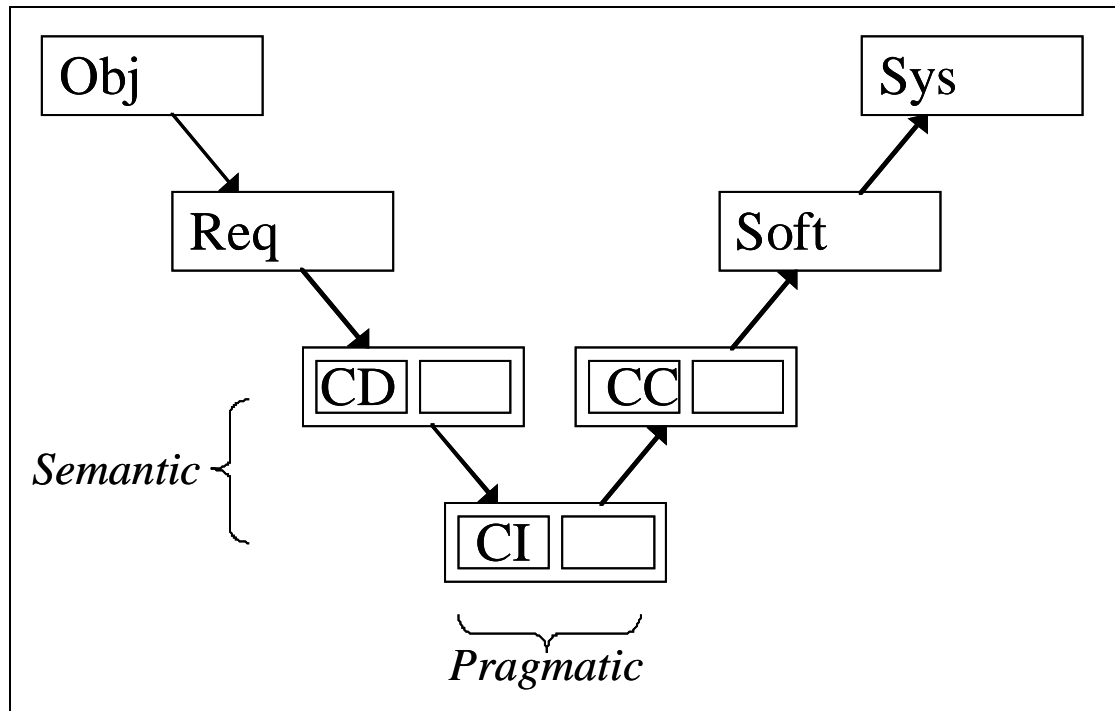

Figure 135. Semantic and pragmatic errors in V-model of software development life-cycle: Objective à Requirements à Component Design à Component Implementation Component Configuration à Software à System.

Typically semantic errors are a discrepancy between two layers of the V-diagram (see Figure 135), e.g., the requirements do not match the objective, component design does not fulfil requirements, or component implementation does not match the component design. Examples of semantic errors are, e.g., the Titan IV/Centaur case where a parameter had the wrong value and thus the component implementation did not match the design and the aluminium foundry cases where the calendar of the software (requirements) did not match the real world calendar (objective). The 16 studies taken in this validation are described in the Table 22.

Pragmatic errors usually appear between components on the same level of the V-diagram. They are results of misusing communication between software components or computational services provided by other components. Manifestation of pragmatic errors is also often associated with special conditions of the services or communication protocol. An example of such special conditions is the Ariane 5 case, where a transformation between two data types was attempted using an input value that had no representation in the output data type. I.e. the transformation was well defined but only for a subset of values presentable by the input data type. There was no recovery routine for the exception in the transformation.

Table 22. The incident cases involving a software error used for validation of the new approach of classification of software defects.

Case	Error description
Cases with semantic errors:	
Ringhals 2 NPP	Computation did not match requirements
TitanIV/Centaur	Implementation did not match design
Chemical reactor	Requirements did no match objective
Transit system stop-button	Implementation did not match design
Patriot	Implementation did not match design (real/floating point values)
SOHO	After changes system did not match design
Railway system	Resources (implementation) did not match design
Calendar error	System calendar did not match real calendar (leap year)
Difficult names	System requirements did not match objective
Cases with pragmatic errors:	
Ariane 5	Misuse of floating point conversion to integer
Therac 25	Communication between user interface and rest of the system
Misuse of integer	ION Panama Communication between digitization and computation modules
Mars Path Finder	Misuse of bus use protocol
Mars Climate Orbiter	Communication between software modules using different units
Mars Polar Lander	Interpretation of sensor signals
False missile alerts	Recognition of hardware failure

Classification of the errors is not always straight forward. The way the error was introduced into the software often clouds the perspective. E.g., in the Titan IV/Centaur case mistyping a parameter value easily seems like a pragmatic error though in the final software the error is semantic. Also defining the fundamental error is not always clear, i.e., an error observed at one level of analysis can be a result of another error observable at a deeper level of analysis. Also, there are often contributing factors that allow the error to result in an accident. Sometimes such factors can themselves be classified as semiotic errors, like the testing of Ariane 5 software using Ariane 4 flight data can be described as a semantic error between operating conditions (actual objective) and testing conditions (objective implied by testing). Some contributing factors are lapses in the development/verification/validation process or organizational problems in communication.

Conclusions

A new approach for the classification of software defects has been given. The approach is based on three aspects of computer semiotics: syntactic, semantic and pragmatic. Syntax errors are incorrect use of language; the program does not pass by the compilers. Typically semantic errors are a discrepancy between two development layers of the V-model of software life-cycle; whereas pragmatic errors occur between components on the same level of the V-model.

Important principles of any classification are the concepts of orthogonal and completeness. Because of this, sixteen incidents involving software errors were studied and set into the new classification. The case studies indicate that classification of the errors is not always straight forward. The completeness of computer semiotic defects holds; the three semiotic error classes are sufficient, but the orthogonal principle concerns only individual phases of software life-cycle. This is because the semiotic errors change their type between phases. That is why, for example the domain factual error (e.g. wrong set value) can result as run time error. However, even if semantic errors can cause crashes of application program; these errors can be reliably caught by exception handlers of run time systems.

The new approach supports identifying the subset of defects to be eliminated by design and testing tools. As syntax defects are caught by compilers, and semantic defects best by run time systems and experimental methods, pragmatic defects are more cumbersome. Pragmatic errors cover several kinds of misinterpretations between components and between designers as previous incidents due to software errors have been indicated. The cause of these errors can be in semantic error. Even if pragmatic errors can be detected by experimental means and self diagnostics, the best means to avoid them are careful study of interaction behavior of components with different features.

More research work is needed for understanding the concept of computer semiotic defects. To understand more about computer defects support us to develop more effective tools (model checkers, automated test case generators, computer aided design, etc.) to prevent these defects occurring.

References

1. Krogstie, J., Berg, E. & Sandvold, Ø. Groupware Support for using Quality Function Deployment in Software Requirements Specifications. In Proceedings of Incorporating the 4th International Symposium on Quality Function Deployment. Sydney, Australia, 2–5 August, 1998. Pp. 107–118.

2. Lindland, O. J., Sindre, G., Sølvsberg, A. Understanding quality in conceptual modelling. *IEEE Software*, March 1994, pp. 42–48.
3. Laprie, J.-C. (ed.). Dependability: basic concepts and terminology. In: *Dependability Handbook*. Toulouse, France: Laboratory for Dependability Engineering. (LAAS Report no. 98-346). 290 p.
4. Chillarege, R., Bhandari, I. S., Char J. K., Halliday, M. J., Moebus, D. S., Ray, B. K. & Wong, M.-Y. Orthogonal Defect Classification – A concept for in-process measurements. *IEEE Transactions on Software Engineering*, 1992, Vol. 18, No. 11.
5. IEEE 1044. IEEE Standard Classification for Software Anomalies. New York, NY, USA, 1993.
6. Cristian, F. Understanding fault-tolerant distributed systems. *Communications of the ACM*, 1991, Vol. 34, pp. 56–78.
7. Peirce, C. S. *Collected Papers of C. S. Peirce*, Hartshorne, C. & Weiss, P. (eds.). Harvard University Press Cambridge, Mass. 1931/1935.
8. Liu, K. *Semiotics in Information Systems Engineering*. Cambridge University Press, Cambridge. 2000. ISBN 0521593352. 230 p.
9. Stamper, R. K. Information: Mystical fluid or a subject for scientific enquiry? *The Computer Journal*, 1985, Vol. 28, No. 3.

24. Influence of Whiskers to Reliability of Electronics, Prestudy (WHISKE)

24.1 WHISKE summary report

Helge Palmén, Antti Turtola & Hannu Hossi
VTT

Abstract

The target of this prestudy was to study the reasons of the whisker growth in metals like tin (Sn) and zinc (Zn), the influences of the manufacturing process and environment during operation on this growth and the impact of whiskers on the reliability of electronics.

Introduction

Whiskers are electrically conductive, crystalline structures of one metal that sometimes grow from surfaces where this metal is used as a final finish. Whiskers have been observed to grow to lengths of several millimeters (mm) and in rare instances to lengths up to 10 mm. Whiskers are not a new phenomenon. Indeed, the first reports of zinc, cadmium and tin whiskers date back to the 1940s.

A single accepted explanation of the whisker growth mechanisms has not been established. But according to the literature and many recent observations, whisker growth might be driven by two key factors: Formation of intermetallic compounds, which is accompanied by a build-up of bi-axial microstress in the metal layer, and the ability of such metal layers to release this stress by pathways different from whisker growth. The amount of intermetallics is mainly a property of the substrate. It will therefore be determined how much intermetallic is formed depending on time, temperature, and substrate.

With the introduction of legislation, the RoHS-directive (Directive on the restriction of the use of certain hazardous substances in electrical and electronic equipment, 2002/95/EC), the date of lead-free electronics is now fixed as 1 July 2006 [1]. The change from tin/lead compounds to lead-free ones creates a potential reliability risk at electronics.

Main objectives

The influence of whiskers on the reliability of electronics

The influence of whiskers on the reliability of electronics has been studied by collecting information from Finnish and international research projects. At the same time the changes of materials in electronics due to the RoHS-directive have been studied. This has partly been done with participation in international conferences.

Participation in IEC TC45 standardisation work

The development of the new IEC-standard, IEC 62342: Nuclear power plants – Management of aging of nuclear power plant instrumentation and control and associated equipment (45A/441/NP), has continued.

Main results

The influence of whiskers on the reliability of electronics

Whiskers are electrically conductive, crystalline structures of one metal like Tin, Zinc, Cadmium, Indium and Antimony. Sometimes these metals grow from surfaces where they are used as a final finish. The more pure the metal finish is the more likely it is that there whiskers may grow. Whiskers are typically short, but they can grow to lengths of several millimeters (mm) and in rare instances in the case of tin whiskers to lengths up to 10 mm.

Often whiskers cause only cosmetic problems to the metal finish, but because whiskers are electrically conductive they can cause failures in electronic systems. It has been suspected that numerous system failures have been attributed to short circuits caused by whiskers that bridge closely-spaced circuit elements maintained at different electrical potentials. Many of these failures have been only short system malfunctions and no whiskers have been found at the “scene of the crime”. That’s because whiskers have not been looked after or the whisker has been destroyed during the short circuit. NASA Goddard Space Flight Center maintains homepage for tin other metal whiskers (<http://nepp.nasa.gov/whisker/>). In those pages several stories and descriptions of whisker based failures can be found.

Whiskers are sometimes confused with a more familiar phenomenon known as dendrites. It is important to note that whiskers and dendrites are two very different phenomena. A whisker generally has the shape of a very thin, single filament or hair-like protrusion that emerges outward from a surface. Dendrites, on the other hand, form

in fern-like or snowflake-like patterns growing along a surface rather than outward from it. The growth mechanism for dendrites is well-understood and requires some type of moisture capable of dissolving the metal into a solution of metal ions which are then redistributed by electromigration in the presence of an electromagnetic field.

The introduction of legislation with lead-free electronics (because of the RoHS-directive) creates a potential reliability risk, because pure tin creates easily whiskers. One demonstration of this took place on April 17, 2005, at Milestone Nuclear Generating Station, as a plant unit tripped when the solid state protection system inadvertently generated a safety injection signal at full power operation. The cause of the trip was attributed to the failure of a universal logic board located in the SSPS. The board failure was subsequently determined to be caused by a short from the anode lead of diode to the printed circuit board trace directly beneath it. The short was caused by a tin whisker.

To study the potential of the whisker growth JEDEC (The JEDEC Solid State Technology Association) has published in May 2005 the standard JESD22A121: Measuring Whisker Growth on Tin and Tin Alloy Surface Finishes [4]. It gives test methods that can be used to verify metal finishes and plating processes.

The standard has three tin whisker test conditions:

Temperature Cycling : Min Temperature -55 to -40 (+0/-10)°C
Max Temperature +85 (+10/-0)°C,
air to air; 5 to 10 minute soak; ~3 cycles/hour, 1000 cycles

Ambient Temperature / Humidity Storage:
30 ±2°C and 60 ±3% RH, 3000 hours

High Temperature / Humidity Storage:
60 ±5°C and 87 +3/-2% RH, 3000 hours.

The standard also gives guidelines for visual analysis of the whiskers. The standard is made for tin whiskers but it can be used for other metal finishes. iNEMI (The International Electronics Manufacturing Initiative) has published acceptance criteria for tin platings. According to the standard whiskers can grow up to 40–67 µm during the test before the metal finish is rejected. But according to the document at mission or life critical, high-reliability applications (like military, space and medical applications) pure tin metal finishes may not be used at all.

Reima Lahtinen and Tom E. Gustafsson have showed in their studies reasons for zinc whiskers [5, 6].

In their investigations the following preconditions for whisker growth on hot dip galvanised zinc coatings were found:

- Small crystal size, corresponding to dull HDG surface.
- Chlorine and sulphur must co-exist and the amount of chlorine must be greater.
- Temperature fluctuations are required, but they can be small and slow (intergranular fretting)
- Compressive stresses in the coating.

A possible local heating mode can in some cases involve photon absorption and the decay of the absorbed energy to heat.

The anisotropic nature of CTE of zinc crystal and the small crystal sizes (dull surface) are the major cause for zinc whisker growth on HDG zinc coatings.

It seems to be that there are similarities between the growth mechanism of tin and zinc [8].

Participation in IEC TC45 standardisation work

The development of the new IEC-standard, IEC 62342 Nuclear power plants – Management of aging of nuclear power plant instrumentation and control and associated equipment, was finished in to a final draft [2]. The second phase has included revising the first working document [3] in to a committee draft (CD) on the Management of aging of electrical cable systems.

A new working item on condition monitoring was also discussed during the last working group meeting in November [7].

References

1. Directive 2002/95/EC of the European Parliament and of the Council, of 27 January 2003, on the restriction of the use of certain hazardous substances in electrical and electronic equipment.
2. IEC 62342 Ed. 1.0 FDIS1 Nuclear power plants – Instrumentation and control important to safety – Management of aging.

3. 45A/615/RVD, WD2 Methods for nuclear power plants – I&C systems important to safety – Management of aging of electrical cable systems.
4. JESD22A121, Measuring Whisker Growth on Tin and Tin Alloy Surface Finishes. The JEDEC Solid State Technology Association (JEDEC), May 2005.
5. Lahtinen, R. & Gustafsson, T. E. The Driving Force Behind Whisker Growth. Part 1, Metal Finishing issue 103/11, New York, U.S.A.
6. Lahtinen, R. & Gustafsson, T. E. The Driving Force Behind Whisker Growth. Part 2, Metal Finishing issue 103 / 12, New York, U.S.A.
7. Palmén, H. Ageing performance of electromagnetic relays – evaluation based on a five year in-service study and a life test. VTT Industrial Systems. International Workshop on “Practical Applications of Age-Dependent Reliability Models and Analysis of Operational Data”, 5–6 October 2005, Fontenay aux Roses, France.
8. Palmén, H., Turtola, A. & Hossi, H. Influence of Whiskers to Reliability of Electronics. VTT research Report, NRO VTT-R-00856-06, Espoo, 31.1.2006. 15 p. (In Finnish).

25. Organisational culture and management of change (CULMA)

25.1 CULMA summary report

Teemu Reiman & Pia Oedewald
VTT

Introduction

Accident investigations and empirical studies have shown that human and organizational failures dominate in most incidents and accidents [7]. More and more accidents in various safety critical organizations are attributed to organizational factors such as norms, procedures, responsibilities, managements systems and company culture [1, 3, 8]. On the other hand, it has been acknowledged that organizational culture can support the safety of the overall system and promote both efficiency and safety of the employees [17, 20, 21]. The emphasis on safety science has been shifting from individual errors to organizational factors and their safety impacts. A major challenge is to assess and change the culture before it leads to accidents. There has previously been little research on how to assess the organization of a NPP and how to identify the risks associated with various organizational phenomena proactively. Consequently, no coherent theory of organizational factors and safety exists. Thus, there was a need for a research project focusing on both practical cases studies and theoretical work on organizational factors.

Main objectives

The main objective of the research project was to increase the understanding of the effects of organizational factors on nuclear safety. The project aimed to produce knowledge of the effects of organizational culture, organizational changes and different ways of organizing work on nuclear safety. The practical goal was to develop methods and models for taking organizational factors into account e.g. in change situations and development initiatives so that all of the criteria for an effective organization (safety, productivity and health, see ref. [19]) are adequately considered. The project also continued the work started in FINNUS/WOPS [10] aiming at developing a methodology for assessing the organizational and safety culture at NPPs.

The goals of the CULMA-project 2003–2006 were

1. Produce knowledge on the new ways of organizing work and the organizational challenges of the nuclear power industry
 - examine the organizational changes and development initiatives that have been carried out by the nuclear power companies
 - generate recommendations for supporting organizational changes and development initiatives at the NPPs.
2. Create organizational psychological theory on safety critical organizations
 - produce knowledge on the internal dynamics of safety critical organizations in order to contribute especially to management of change and development of competence at the NPPs
 - identify the special characteristics of the organizational culture of the safety critical organizations
 - clarify cultural tensions and issues of dissent at the NPPs.
3. Exploit and improve the Contextual Assessment of Organizational Culture (CAOC) methodology piloted during the FINNUS research programme:
 - verify and validate the methodology
 - improve the CAOC methodology to make it easier and more efficient to apply by the end users and/or the researchers.

Research strategy

The CULMA project has been carried out by conducting case studies in combination with theoretical work on organizational factors and safety.

Case studies

- A case study on organizational culture at TVO maintenance unit was conducted in 2002–2003 (started with NKS funding).
- This was followed by case study on the socialisation and training of newcomers in maintenance and a remeasure of maintenance culture in 2006. Suggestions to improve the maintenance culture were given at all stages.
- Also a measure of the conceptual understanding of the maintenance work and the plant technical specifications was created for evaluating the effectiveness of the training process at TVO.
- The use of subcontractors in the nuclear industry was researched in 2003 by conducting a literature review and a small case study at TVO.

- In 2005–2006, an assessment of organizational culture at TVO Power Plant Engineering was done.
- At Loviisa NPP, a remeasure of the maintenance culture (originally assessed during the FINNUS/WOPS project) was done in 2004.
- A case study on the Loviisa NPP organizational change 2002 was carried out.
- In 2005 the researchers participated in a change project focusing on production management at the Loviisa NPP and evaluated the benefits and risks of applying process thinking in the organization.
- In addition to the case studies, organizational changes made in Finnish and Swedish power companies' maintenance units and their safety impacts have been clarified.

Theory and methodology development

- Theoretical work on organizational assessments, organizational changes and characteristics of organizational culture at the nuclear power plants has been carried out
- Five scientific articles and eleven conference papers have been published focusing on psychological issues concerning the assessment of NPPs and the psychological requirements of work in NPPs
- Dissertation concerning the development and application of the CAOC methodology in maintenance domain has been submitted for review.

International networks and cooperation

The Culma project has strived to create a network of human factors researchers and professionals, to disseminate the public results of the project, and to keep up to date on the state of the art on human factors in other countries. The project members have

- presented and discussed the results of the project in ten different international conferences/workshops
- participated in IAEA technical meeting on event investigation techniques
- participated on IAEA/SCART mission to South Africa
- attended and hosted seven Nordic Safety Management Network meetings coordinated by Prof. Ola Svenson and Dr. Ilkka Salo
- hosted the first meeting of the Finnish Human Factors and Safety network (see Figure 136)

- participated in the first meeting of the HUSC (Finnish and Swedish power companies' Safety Culture and MTO network)
- co-edited a book on Nordic Perspectives to safety management [18] where results from different safety critical domains are presented.



Figure 136. Professor James Reason giving a presentation at the first Finnish Human Factors and Safety network meeting hosted by the CULMA project in February 2006. The meeting had over 70 participants from various industries and research institutes.

A Finnish language book on the special characteristics of organizational culture at safety critical organization has also been written [5]. During the writing of the book, views from aviation, oil industry and chemical industry were gathered by interviews. Additional interviews were also made in the nuclear industry.

Main results

Organizational challenges and ways of organizing work

NPPs in Finland are facing pressures for organizational changes due to e.g. deregulation of the electricity markets, aging technology and the generation turnover. According to the results of the CULMA project, organizational changes clearly are issues that have potential effects on safety. Both positive and negative cases on safety effects of organizational changes exist. Our case studies revealed e.f. problems in communication, unclear responsibilities, deteriorating working climate and increased stress as a consequence of reorganizations [16]. Experiences and recommendations for conducting organizational changes have been reported and a model for describing the

organizational aspects having a potential safety impact in the change process was created [16].

Major organizational changes have received increasing attention in the nuclear industry and the risks associated with them are beginning to be analysed more systematically [16]. Less attention has been devoted to smaller, more incremental changes in organizational structures, tools and practices. These are also organizational changes and being usually non-specific in duration, less immediate in outcomes and less analyzed in possible consequences and interrelations, they are a potential source of gradual drift in practices and culture toward an unsafe condition (cf. Figure 137 and ref. [14]).

One of the organizational challenges is that the activity in the NPPs is very much based on the tacit knowledge of the workers and on unofficial working practices. The current practices and the best way of carrying out the work cannot thus easily be described and documented. Thus, it is hard to anticipate the effects of changes on the organization and also hard to outsource activities to subcontractors who do not know the plant and its culture.

Organizational psychological theory on safety critical organizations

We have defined and applied two concepts that can be used in understanding and assessing complex industrial organizations, namely the concepts of organizational core task (OCT) and organizational culture. The aim was to create a model of organizational dynamics in order to be able to understand the continuous and often unintentional change and drift in practices that are not always optimal in terms of safety.

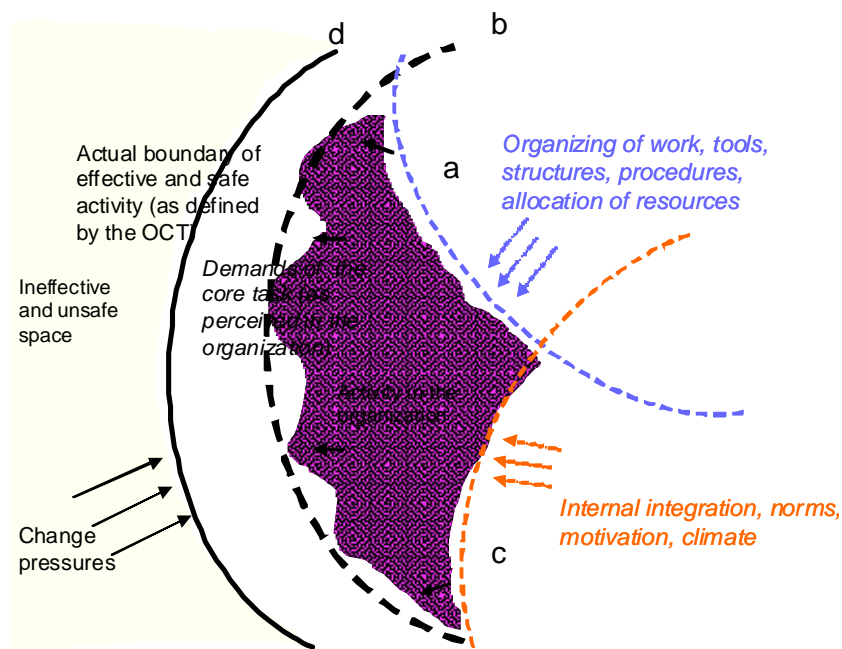

Figure 137. Activity in the organization is influenced by the three cultural elements, adapted from Reiman and Oedewald [14], see also [6].

Organizational culture defines and manifests in A) visible structures, tools and descriptions that the organization has chosen or created, B) conceptions concerning the goals they are trying to achieve and limits of safe and efficient functioning, C) integration and norms of the people working together [9, 14]. Thus, it can be claimed that organizational culture frames the activity of the system. The dynamics of organizational culture is illustrated in Figure 137 using the graphical presentation format that resembles visually the format that Rasmussen [6, p. 190] has used

In the Figure 137, line D represents the actual boundary of effective and safe activity as dictated by the overall goals the organization is trying to achieve. We call that Organizational Core Task (OCT). Line B represents the demands of the OCT as they are perceived in the organization (the perceived boundary). Line A indicates the influence of resources, tools, organizational structures and procedures on the activity. Line C indicates the influence of the internal integration of the culture (norms, sources of motivation, and climate) on the organizational activity. The space between lines A-C defines the area of normal organizational activity. The lines A-C are not outside pressures affecting the system, rather they are aspects of the organizational culture created and maintained by the organization [14]. The CAOC methodology that is discussed next is based on these theoretical premises. Methods and models based on this theory have also been developed. These are elaborated in the Applications Section and in a separate article in this publication.

Contextual Assessment of Organizational Culture (CAOC) methodology

The subproject continued the work done in FINNUS/WOPS-project to develop a methodology for contextual assessment of organizational culture (CAOC). CAOC-methodology has been applied in case studies where the organizational culture has been described along the dimensions shown in Figure 137. Organizational core task analysis has been used to model the requirements of the work and the actual boundary of safe activity (line A in Figure 137). The specific methods comprising the CAOC methodology have been validated and improved. For case examples, see [11, 12, 13, 15]. Outside the SAFIR programme, the CAOC methodology has been applied and further validated in e.g. eleven metal manufacturing organizations and three health care organizations.

Applications

The results and knowledge produced by the CULMA project have been applied in e.g. event investigations by the power companies and STUK, periodic safety review of Loviisa NPP, annual planning and identification of development initiatives by the case organizations, and development of TVO maintenance training programs. Furthermore,

the results can be applied in planning and conducting organizational changes, in implementing methods for human performance improvement and in developing safety culture.

The CULMA project has also developed a number of methods and models that have practical relevance for the development of safety in the nuclear industry. The models include a model of the work motivation at safety critical organizations [4, 15], model of the special characteristics of safety critical organizations [5], model of the safety effects of organizational changes [16], model of safety management principles [9, Reiman & Oedewald this publication] and a model of the organizational drift [9, 14]. The methods include organizational culture questionnaire [9, 12] and a measure of the theoretical knowledge of the TVO maintenance personnel.

Future research needs and challenges concerning organizational issues

The CULMA project has identified a number of issues requiring attention in the future. There exist plenty of methods and models for tackling human error and improving human performance. The problem with these methods is that they seldom make explicit on what kind of a model of an organization and individual behaviour they are based. The implementation of these methods may fail or the methods are counterproductive if they are based on an inadequate picture of the way people and organizations actually behave. The organizational level phenomena and their safety effects also require more conceptual and practical work, especially incremental changes in culture. Furthermore, the influence of the ways of organizing work on the nuclear safety such as the increased use of subcontractors requires research. A challenge for research and practice are the identification and creation of conditions that support the personnel's understanding of the safety significance of one's own work. Also conditions for the creation of a realistic sense of control and a sense of personal responsibility need more research.

To summarize, in the future research on both accidents/risks *and* safety are needed. Most safety research is actually research on risks or incidents/accidents. Still, safety is more than the absence of accidents or the negation of risks. The organizational conditions and prerequisites of safety need to be elaborated and ways to support the organizational perception of the boundaries of safe operation and ways to support the organizational practices of steering away from these boundaries when needed have to be elaborated [2].

References

1. ACSNI. Organising for safety. Third report of the Human Factors Study Group of the Advisory Committee on Safety in the Nuclear Industry. Health & Safety Commission. London: HMSO, 1993.
2. Dekker, S. W. A. Ten questions about human error. A new view of human factors and system safety. New Jersey: Lawrence Erlbaum, 2005.
3. Hollnagel, E. Barriers and accident prevention. Aldershot: Ashgate, 2004.
4. Oedewald, P. & Reiman, T. Enhancing maintenance personnel's job motivation and organizational effectiveness. CSNI workshop on Better Nuclear Plant Maintenance: Improving Human and Organisational Performance. Ottawa, Canada. 3–5 October 2005.
5. Oedewald, P. & Reiman, T. Turvallisuuskriittisten organisaatioiden toiminnan erityispiirteet. VTT Publications 593. Espoo, VTT, 2006. 108 p. + app. 10 p. ISBN 951-38-6698-X; 951-38-6699-8.
<http://virtual.vtt.fi/inf/pdf/publications/2006/P593.pdf>.
6. Rasmussen, J. Risk management in a dynamic society: A modelling problem. Safety Science, 1997, Vol. 27, pp. 183–213.
7. Reason, J. Human error. Cambridge: Cambridge University Press, 1990.
8. Reason, J. Managing the risks of organizational accidents. Aldershot: Ashgate, 1997.
9. Reiman, T. Assessing organizational culture in complex sociotechnical systems – Methodological evidence from studies in nuclear power plant maintenance organizations. (In review).
10. Reiman, T. & Oedewald, P. Contextual Assessment of Organizational Culture – methodological development in two case studies. In: Kyrki-Rajamäki, R. & Puska, E-K. (eds.). FINNUS. The Finnish Research Programme on Nuclear Power Plant Safety, 1999–2002. Final Report. VTT Research Notes 2164. Helsinki: Yliopistopaino, 2002. 267 p. + app. 66 p. ISBN 951-38-6085-X 951-38-6086-8. Pp. 251–260. <http://virtual.vtt.fi/inf/pdf/tiedotteet/2002/T2164.pdf>.

11. Reiman, T. & Oedewald, P. Kunnossapidon organisaatiokulttuuri. Tapaustutkimus Olkiluodon ydinvoimalaitoksessa. VTT Publications 527. Espoo: VTT Tuotteet ja tuotanto, 2004. 63 p. + app. 8 p. ISBN 951-38-6371-9; 951-38-6372-7. <http://virtual.vtt.fi/inf/pdf/publications/2004/P527.pdf>.
12. Reiman, T. & Oedewald, P. Measuring maintenance culture and maintenance core task with CULTURE-questionnaire – A case study in the power industry. *Safety Science*, 2004, Vol. 42, pp. 859–889.
13. Reiman, T. & Oedewald, P. Assessing the maintenance unit of a nuclear power plant – identifying the cultural conceptions concerning the maintenance work and the maintenance organization. *Safety Science*, 2006, Vol. 44, pp. 821–850.
14. Reiman, T. & Oedewald, P. Assessment of Complex Sociotechnical Systems – Theoretical issues concerning the use of organizational culture and organizational core task concepts. *Safety Science*. (In press).
15. Reiman, T., Oedewald, P. & Rollenhagen, C. Characteristics of organizational culture at the maintenance units of two Nordic nuclear power plants. *Reliability Engineering and System Safety*, 2005, Vol. 89, pp. 333–347.
16. Reiman, T., Oedewald, P., Rollenhagen, C. & Kahlbom, U. Management of change in the nuclear industry. Evidence from maintenance reorganizations. *MainCulture Final Report. NKS-119. Nordic nuclear safety research, Roskilde*, 2006.
17. Roberts K. New challenges in organizational research: high reliability organizations. *Industrial Crisis Quarterly*, 1989, Vol. 3, pp. 111–125.
18. Svenson, O., Salo, I., Skjerve, A. B., Reiman, T. & Oedewald, P. (eds.). *Nordic perspectives on safety management in high reliability organizations: Theory and applications*. Valdemarsvik: Akademitryck, 2006.
19. Vicente, K. *Cognitive work analysis. Toward safe, productive, and healthy computer-based work*. London: Lawrence Erlbaum, 1999.
20. Weick, K. E. Organizational culture as a source of high reliability. *California Management Review*, 1987, Vol. 29, pp. 112–127.
21. Weick, K. E. & Sutcliffe, K. M. *Managing the unexpected. Assuring high performance in an age of complexity*. San Francisco: Jossey-Bass, 2001.

25.2 Organizational factors, management, and nuclear safety

Teemu Reiman & Pia Oedewald
VTT

Abstract

Organizations that operate in high hazard domains are expected to function reliably and to anticipate the operating risks caused by the technology itself and the organizational practices. It is widely acknowledged that organizational reliability requires more than clear procedures and compliant people. Nuclear power plants are complex sociotechnical systems where goal conflicts and interdependencies between different functions are inevitable. The technology, structures and procedures as well as the people working in the power plants are constantly changing. Safety management should aim at identifying the changing vulnerabilities of the organization and evaluating how the actions taken to improve safe performance actually affect the reliability of the organization. CULMA-project has carried out various organizational assessments in Nordic nuclear power plants and identified conflicting opinions on how to approach organizational reliability. Four principles for improving organizational performance are suggested based on our results from the organizational assessments and the latest research on safety critical organizations.

Introduction

Organizations that operate in high hazard domains face extraordinary demands from the society. They are expected to function reliably and to anticipate the operating risks. The approaches to risk management and initiatives to improve safety have developed gradually during the decades. Different steps have been taken in the area of human and organizational factors. It can be said that human factors research started over a hundred years ago, and since then many steps have been taken to reduce the failure of human-machine interaction. As shown in Figure 138, usability tests, aptitude tests, task design, and training have been utilized in different domains for decades. Major accidents have increased the demand for managing human performance and thus, they have facilitated the development of new concepts and tools for analysing failures and protecting the systems from human error.

Figure 138 shows that the research and development work on human and organizational factors has focused on controlling human performance and creating system barriers to prevent errors and mitigate their effects. The safety culture approach that followed the

Chernobyl accident placed more emphasis on organization issues. The safety culture approach does not, however, differ essentially from the previous traditions [12]. Its purpose is to develop organizational norms, values and practices which ensure that all the known failure prevention practices are actually utilized.

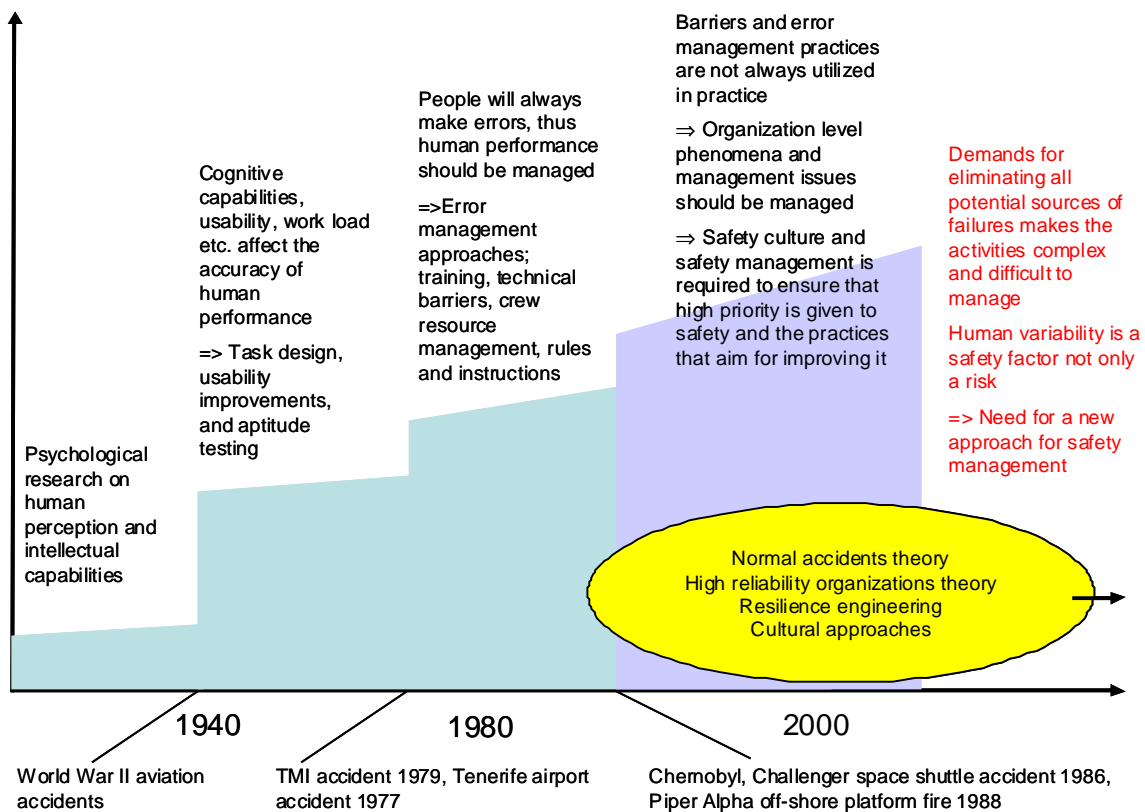

Figure 138. Development of human and organizational factors approaches.

The tools and practices that are used for managing risks have accumulated across time. In fact, many safety scientists and organizational factors specialists state that the organizational structures, safety systems, procedures and working practices have become so complex that they are creating new kinds of threats for reliable functioning of the organization [8, 15]. The risks associated with one's own work may be more difficult to understand, people may exhibit faulty reliance on safety functions such as redundancy and blind reliance on procedures and the organization may experience difficulties in responding to unforeseen situations due to complex responsibilities. For this reason, safety researchers have started to develop new approaches for analysing and supporting human and organizational reliability and the overall safety of the system.

High reliability organizations or normal accidents?

The High Reliability Organization group, HRO, [3, 14] formed in 1984 at the University of Berkeley by Todd La Porte, Karlene Roberts and Gene Rochlin, and the work of Karl

Weick at the University of Michigan [16, 17] have been influential in illustrating the organizational aspects of safety and reliability of safety critical organizations.

The HRO theories emphasize the significance and possibilities of training and good organizational design and management including redundant organizational structures, the prioritization of safety as an overriding goal, and decentralized decision making in times of crises for creating a “high reliability organization” capable of “nearly failure-free” operations [3, 4, 13]. Weick and Sutcliffe [18] have extracted many interesting general features and characteristics of high reliability organizations: constant preoccupation with the possibility for failure, continuous improvement and learning, reluctance to accept simplifications of reality, sensitivity to daily operations, deference to expertise and commitment to resilience.

On the other hand, the advocates of Normal Accidents Theory, NAT, [8, 9, 15] have illustrated the potential dangers of interactive complexity (which produces bizarre and unanticipated failures) and tight couplings (which cause the failures to escalate rapidly out of control) prevalent in e.g. nuclear industry, modern weapons systems, aviation and chemical industry. Perrow [9, p. 3] writes that “no matter how much training, how many safety devices, planning, redundancies, buffers, alarms, bells, and whistles we build into our systems, those that are complexly interactive will find an occasion where the unexpected interaction of two or more failures defeats the training, the planning, and the designing of safety devices”. Sagan [15] has presented an overview of the main differences between HRO and NAT (Table 23).

These theories are not mutually exclusive when analysing organizations. HRO examines organizations more optimistically in terms of precursors to success, whereas NAT examines the same organization in more pessimistic light in terms precursors to failure. Lessons from both theories should be incorporated into an effective safety management of nuclear installations.

Recently, the term *resilience* has been introduced into safety science [2]. In a book called “Resilience Engineering”, Woods and Hollnagel [20] argue that safety is created through proactive resilient processes rather than reactive barriers and defences. The resilience engineering approach strives for anticipating the constantly changing organizational behaviour and tries to define what information the organization needs in order to be able to steer itself safely and flexibly. They stress the importance of analysing the inherent conflicts of the everyday work, for example the prescriptions of work versus the way the work is actually carried out or efficiency versus thoroughness in the work.

Table 23. Competing perspectives on safety with hazardous technologies [15].

<i>High Reliability Theory</i>	<i>Normal Accidents Theory</i>
Accidents can be prevented through good organizational design and management	Accidents are inevitable in complex and tightly coupled systems
Safety is the priority organizational objective	Safety is one of a number of competing values
Redundancy enhances safety: duplication and overlap can make “a reliable system out of unreliable parts.”	Redundancy often causes accidents: it increases interactive complexity and opaqueness and encourages risk-taking.
Decentralized decision-making is needed to permit prompt and flexible field-level responses to surprises.	Organizational contradiction: decentralization is needed for complexity, but centralization is needed for tightly coupled systems.
A “culture of reliability” will enhance safety by encouraging uniform and appropriate responses by field-level operators.	A military model of intense discipline, socialization, and isolation is incompatible with [American] democratic values.
Continuous operations, training, and simulations can create and maintain high reliability operations.	Organizations cannot train for unimagined, highly dangerous, or politically unpalatable operations.
Trial and error learning from accidents can be effective, and can be supplemented by anticipation and simulations.	Denial of responsibility, faulty reporting, and reconstruction of history cripples learning efforts.

Our case studies have shown that the employees in nuclear field face the inherent conflicts of safety critical work. There exists conflicting opinions and beliefs about many basic safety management themes, for example how well the risks can be described and calculated, what is the right level of proceduralizing work, what should be trained and how responsibility is allocated [6, 10, 11]. Thus, we state that safety management approaches should avoid too general and idealistic models of safe organizations. Safety management should aim at identifying the changing vulnerabilities of the organization [19] and evaluating how the actions taken to improve safe performance actually affect the reliability of the organization [see also 10]. Attention should be paid to the challenges and conflicts of daily work as well as to the cultural opinions and beliefs about safety and risks prevalent in the given organization.

Applications for safety management

We propose four principles for improving organizational performance in safety critical domains. These principles should be incorporated into safety management process. The principles will be elaborated next.

Commitment and motivation of the personnel

Committed and motivated people are of crucial importance for guaranteeing the manageability of complex systems. Work motivation and commitment depend on work design and content of work. The so called context factors such as salary or congeniality have secondary importance. A challenge for NPP safety management is to be able to build organizational structures, practices and norms that would facilitate the following psychological conditions of work motivation: a sense of meaningfulness of work, a possibility to see the results of one's own work (goal clarity), good working and communication climate, a realistic sense of control over one's own work, and a sense of personal responsibility over the plant [5, 6]. An understanding of the safety significance of one's own work is of utmost importance in providing motivation and meaningfulness as well as promoting sense of personal responsibility. The psychological conditions are influenced by the preconditions of the work.

Adequate preconditions of the work

The personnel should have the ability to carry out the task appropriately. This includes taking care of the competence of the personnel and providing adequate tools. Furthermore, procedures should be up to date and adequate for the daily work, and resources sufficient for carrying out the work thoroughly. One important precondition of work is the way the work is organized. The organizational structures should provide the worker an overall picture of the work process and allow fluent working. If the preconditions of the work are not optimal, the psychological conditions suffer. For example, lack of resources can lead to a perceived lack of control. Unclear responsibility areas or division of labor can diminish sense of personal responsibility or the perceived meaningfulness of the work. In the worst case, the current tools and practices can hamper the perception of the safety impacts and risks of the work.

Helping the organization to perceive the organizational core task and the associated risks

The workers and the management should have an understanding of the organizational core task and what demands and risks it sets for the organizational activity. This is demanding for many reasons; (1) the current tools and practices guide the way people think and act, the current culture can "blind" the personnel for some risks, (2) the demands and risks change incrementally, which is difficult to notice in daily work and (3) also the culture of the organization changes gradually, potentially creating new risks. Organizations seek to manage and control those risks that they consider or believe to be of importance for safety. Thus, it is important to reflect on the accuracy of these beliefs, since risks that are not considered are not consequently controlled.

Continuous and proactive safety management process

Proactive safety management is dependent on keeping the cultural conceptions concerning the organizational core task and its demands up to date. The organizations should have a “capability to recognise the boundaries of safe operations, a capability to steer back from them in a controlled manner, a capability to recover from a loss of control if it does occur” [1, p. 45]. Woods and Cook [19] have stated that the progress on safety depends on providing the workers and management with information about the changing vulnerabilities of the system as well as on the ability to develop new means for meeting these. This implies that safety is never a static state; it is a dynamic non-event [16] and requires constant effort to achieve.

An important requirement for effective safety management is the preparation for surprising events. In complex environments, everything cannot be predicted. Organizations should prepare for handling unexpected events or phenomena with slack resources, competence and working practices.

Discussion

The Finnish nuclear power plants and the regulator are currently carrying out different types of organizational evaluations. In these evaluations more emphasis is still placed on the assessment of technical solutions and structures than on organizational performance. In order to understand the overall vulnerabilities of the system there should be more work done to integrate the views. The technical solutions, organizational norms and values and the workers’ understanding about the overall task and the boundaries of safe activity should be analysed hand in hand because these organizational elements always affect each other. On the one hand, technical solutions affect the way people see their task and risks. On the other hand, the values and attitudes of the people affect the way they utilize new technology. We recommend that assisted self assessments should be conducted e.g. when there are changes in the organizational structures, new tools are implemented, when the people report increased workplace stress or decreased working climate or when incidents and near misses increase.

Assessment of the overall functioning of the organization has been considered demanding since simple methods and tools are rare and the validity of the various performance indicators is unclear. A comprehensive organizational assessment requires integration of information from different sources and a well planned assessment process. The most critical phase in the organizational assessment is the understanding of what to look for, where and when, not the selection of the assessment methods per se. CULMA project has investigated the usability of subjective measures and workers’ conceptions in organizational assessments. It can be stated that the perceptions of the

people working with these complex systems are indicators of the overall state of the organization [7]. Interviews, working climate surveys and descriptions of the actual work processes (e.g. those that can be seen in event reports) provide valuable information about the general challenges and help in creating possible risk scenarios.

The safety culture assessments and other organizational measures tend to assume a straightforward connection between safety performance of the organization and attitudes towards safety. In case of performance failures it seems to be easier to blame bad attitudes than lack of technical (safety) knowledge. Although the Finnish nuclear organizations have highly experienced employees it should be recognized that misunderstandings, narrow expertise areas, forgetting basic definitions and theories, inability to follow the development of the technology can be found also in nuclear power plants. The organizations may be unaware that there exist misunderstandings about basic safety principles. Thus, it is advisable to evaluate the basic training needs from time to time.

As we have pointed out, human and organizational performance is influenced by the overall organizational system (motivation, prerequisites of work, perceptions of the task, safety management process). In addition to these, human performance can be improved e.g. by training and by utilizing different types of error management tools. The Finnish nuclear organizations have been very deliberate towards error management tools. It is important that these tools can be smoothly integrated to normal work practices. Adding complexity to work processes is a risk factor because it can direct the attention away from the task itself. The task design is as important when implementing practices that aim for improving human and organizational behavior as when implementing new technical tools.

References

1. Dekker, S. W. A. Ten questions about human error. A new view of human factors and system safety. New Jersey: Lawrence Erlbaum, 2005.
2. Hollnagel, E. Resilience – the challenge of the unstable. In: Hollnagel, E., Woods, D. D. & Leveson, N. (eds.). Resilience engineering. Concepts and precepts. Aldeshot: Ashgate, 2006
3. La Porte, T. R. High reliability organizations: Unlikely, demanding and at risk. *Journal of Contingencies and Crisis Management*, 1996, Vol. 4, pp. 60–71.

4. La Porte, T. R. & Consolini, P. M. Working in practice but not in theory: Theoretical challenges of “High Reliability Organizations”. *Journal of Public Administration Research and Theory*, 1991, Vol. 1, pp. 19–47.
5. Oedewald, P. & Reiman, T. Enhancing maintenance personnel’s job motivation and organizational effectiveness. CSNI workshop on Better Nuclear Plant Maintenance: Improving Human and Organisational Performance. Ottawa, Canada. 3–5 October 2005.
6. Oedewald, P. & Reiman, T. Turvallisuuskriittisten organisaatioiden toiminnan erityispiirteet. VTT Publications 593. Espoo: VTT, 2006. 108 p. + app. 10 p. ISBN 951-38-6698-X; 951-38-6699-8.
<http://virtual.vtt.fi/inf/pdf/publications/2006/P593.pdf>.
7. Oedewald, P. & Reiman, T. Using subjective measures to monitor the systems’ capability to manage complexity – evidence from the nuclear industry and health care. In: Hollnagel, E. & Rigaud, E. (eds.). *Proceedings of the Second Resilience Engineering Symposium*. 8–10 November, 2006. Antibes, Juan-Les-Pins, France.
8. Perrow, C. *Normal accidents: Living with high-risk technologies*. New York: Basic Books, 1984.
9. Perrow, C. Accidents in high-risk systems. *Technology Studies*, 1994, Vol. 1, pp. 1–20.
10. Reiman, T. Assessing organizational culture in complex sociotechnical systems – Methodological evidence from studies in nuclear power plant maintenance organizations. (In review).
11. Reiman, T. & Oedewald, P. Assessing the maintenance unit of a nuclear power plant – identifying the cultural conceptions concerning the maintenance work and the maintenance organization. *Safety Science*, 2006, Vol. 44, pp. 821–850.
12. Reiman, T. & Oedewald, P. Assessment of Complex Sociotechnical Systems – Theoretical issues concerning the use of organizational culture and organizational core task concepts. *Safety Science*. (In press).
13. Roberts, K. H. Some characteristics of one type of high reliability organization. *Organization Science*, 1990, Vol. 1, pp. 160–176.

14. Rochlin, G. I. Safe operation as a social construct. *Ergonomics*, 1999, Vol. 42, pp. 1549–1560.
15. Sagan, S. D. *The limits of safety. Organizations, accidents, and nuclear weapons.* New Jersey: Princeton University Press, 1993.
16. Weick, K. E. Organizational culture as a source of high reliability. *California Management Review*, 1987, Vol. 29, pp. 112–127.
17. Weick, K. E & Roberts, K. H. Collective mind in organizations: Heedful interrelating on flight decks. *Administrative Science Quarterly*, 1993, Vol. 38, pp. 357–381.
18. Weick, K. E. & Sutcliffe, K. M. *Managing the unexpected. Assuring high performance in an age of complexity.* San Francisco: Jossey-Bass, 2001.
19. Woods, D. D. & Cook, R. I. Incidents – markers of resilience or brittleness? In E. Hollnagel, D. D. Woods, N. Leveson (eds.). *Resilience engineering. Concepts and precepts.* Aldershot: Ashgate, 2006.
20. Woods, D. D. & Hollnagel, E. Prologue: Resilience engineering concepts. In E. Hollnagel, D. D. Woods & N. Leveson (3ds.). *Resilience engineering. Concepts and precepts.* Aldershot: Ashgate, 2006.

26. Disseminating Tacit Knowledge and Expertise in Nuclear Power Plants (TIMANTTI)

26.1 Tacit Knowledge and Preserving It in Nuclear Power Plants

Tanja Kuronen, Niina Rintala & Katri Säämänen
Helsinki University of Technology

Abstract

Preserving tacit knowledge is important for reliable and competent performance of nuclear power plants. The TIMANTTI project (2004–2006) examined the nature of tacit knowledge and possibilities for improving the preserving of tacit knowledge in Finnish nuclear power plants. This paper defines tacit knowledge as well as its structure and content in NPP context. The challenges in and prerequisites for tacit knowledge sharing are also described. In addition, some good practices for knowledge sharing based on the research findings are provided.

Introduction

Knowledge and the capability to create and develop knowledge has become one of organizations competitive advantages. [see e.g. 1] Organizational knowledge can be divided into explicit and tacit dimension. [2]. Explicit knowledge is or can be codified, documented and transmitted systematically. Tacit knowledge is based on employees' experiences.

Knowledge management efforts in organizations have mostly focused on explicit knowledge and technology intensive solutions. The need for more effective knowledge management practices and for preserving tacit knowledge has increased the past few years due to e.g. employee turnover. Tacit knowledge affects performance. Therefore preserving tacit knowledge in organizations is especially important in high reliability organizations, such as nuclear power plants (NPPs) and air traffic control, where the emphasis is above all on reliable performance. In these organizations losing critical tacit knowledge might compromise their safe operation. High reliability organizations cannot rely on "learning by doing". Consequently, there is often neither information nor experience about the events leading to the most damaging consequences [3]. A different approach to knowledge, learning and preserving competences is needed.

Preserving tacit knowledge has become a current issue in Finnish NPPs because of ageing workforce, many simultaneous retirements and declining interest of the field among students. Many of the employees were involved in designing and building the plants. They have developed cumulated knowledge and profound understanding on the complex and unique technology of the plant and its operation. Preserving this tacit nuclear knowledge is a major challenge for NPPs also internationally [4].

Research approach, methods and research questions

The methodological approach in TIMANTTI project combined action research and inductive case study. A context-specific approach was needed as tacit knowledge takes different forms in different contexts and thus, has to be defined separately in each context. The data consisted of thematic interviews (N=39) in three different organizational units: mechanical maintenance, technical design and control room. The interviewees represented experienced experts, new recruits, instructors of novices and shift supervisors. In addition to individual interviews, data was gathered in two workshops and two group interviews. The data was analyzed with qualitative content analysis.

The TIMANTTI project addressed the following questions in NPP context: 1) What is tacit knowledge in NPPs?, 2) What are the challenges in sharing tacit knowledge?, 3) What are the prerequisites for preserving tacit knowledge? and 4) What methods are or should be used for preserving tacit knowledge?

Tacit knowledge

Tacit knowledge has distinctive features which separate it from explicit knowledge and make it difficult to preserve. **Tacit knowledge is subjective.** It is expertise, gained through experience and interaction with the environment. It includes intangible factors such as culture, values and intuitions [5]. Even though tacit knowledge itself is subjective, the outcomes of tasks performance relying on tacit knowledge, can be objective i.e. observed and evaluated e.g. for quality. **Tacit knowledge is unconscious.** It is often unrecognized in everyday task performance and problem-solving [6]. Experienced employees find it difficult to identify and describe their knowledge, because they are unaware of its tacit dimension. Systematic analysis of skills or knowledge may even hinder the task performance. [7] **Tacit knowledge is valuable.** It contains an inherent contradiction of being intangible, but at the same time a part of all knowledge, problem solving, decision making and task performance [8]. **Tacit knowledge is contextual.** It is connected to the context in which it is acquired and also meaningful only in that specific context. [6, 9]. **Tacit knowledge is difficult to codify and communicate systematically** because it is acquired through implicit learning [7].

Codifying tacit knowledge may lead to excessive documentation, yet failing to distinguish the relevant knowledge. Documentation is also expensive and slow and may not provide a reliable reflection of the knowledge. In addition, the experienced experts may lack skills, motivation and time to document their expertise [10, 11, 12].

Tacit and explicit knowledge are mutually exclusive but complementary and interdependent. Explicit knowledge is needed e.g. in acquiring and applying tacit knowledge. The distinction between these two forms of knowledge is not static – tacit knowledge is continuously converted into explicit knowledge and vice versa [10].

Tacit knowledge in nuclear power plants – role, structure and content

As in other safety critical organizations with highly regulated and instructed operation, also in the nuclear power industry knowledge is considered to be primarily formal and explicit, emphasizing technical know-how and specialized competencies. However, tacit knowledge also has a special importance in the nuclear power industry. The significance of tacit knowledge was seen especially emphasized in knowledge related to e.g. building process of the plants, experiences of plant operation and radioactive waste management [13]. The role of tacit knowledge in the NPP context was considered critical at least for three reasons: 1) nuclear technology is very complex, 2) nuclear know-how is only in hands of a few and 3) safety and quality of plant operation are essential. Hence, some of the same features that define the nuclear power plants as high reliability organizations also form the essential core of tacit knowledge.

Regardless of the work task, the tacit knowledge in studied NPP units could be divided into technical and contextual dimensions of tacit knowledge (Figure 139). *Technical tacit knowledge* consists of specified technological expertise. It is based on education but can only develop with experience. *Contextual tacit knowledge* refers to competence needed to apply the specified technical knowledge in a high risk context.

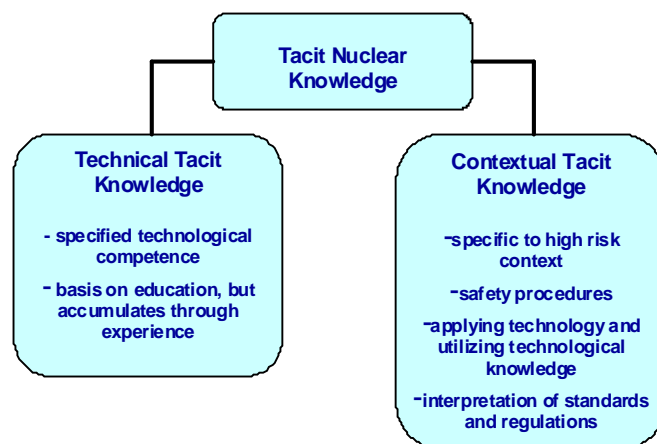

Figure 139. Tacit nuclear knowledge.

The structure of tacit knowledge in studied units is modeled in Figure 140. The tacit knowledge consists of cognitive (know-that and know-why) and of procedural tacit knowledge (know-how).

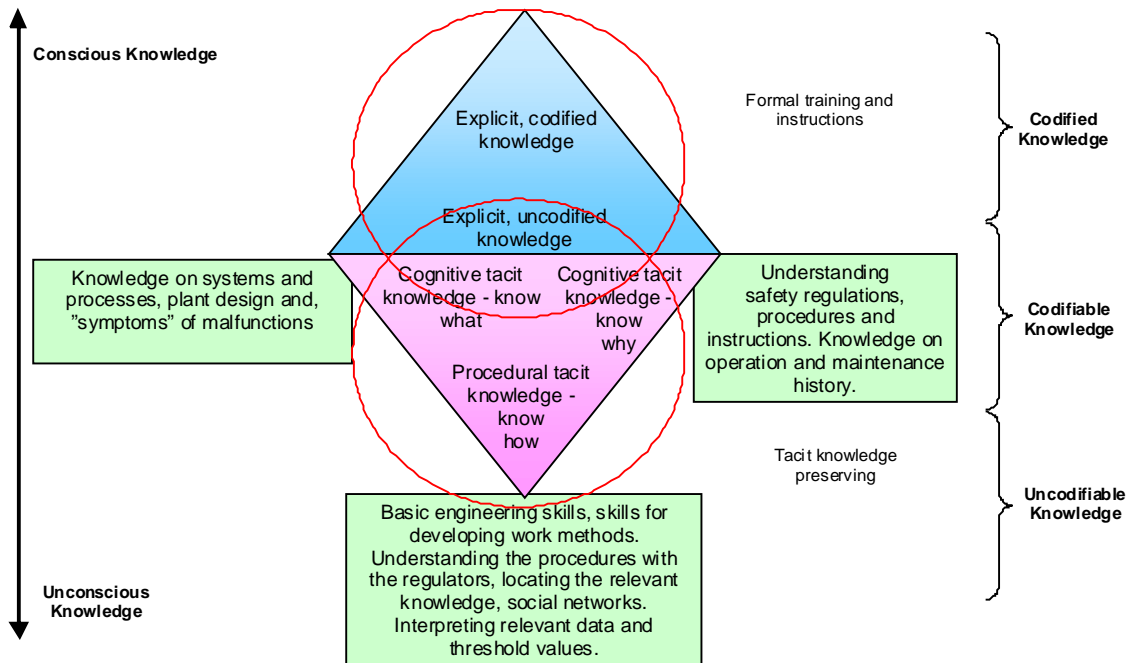

Figure 140. The Diamond Model: The structure of tacit knowledge in NPPs.

Procedural tacit knowledge is entwined with skills and routinized procedures. It is sophisticated technical knowledge which forms the visible part of professional expertise combining knowledge on task design and task performance. *Cognitive tacit knowledge* can be partly codified. It consists of implicit mental models and perceptions that facilitate making distinctions between relevant and irrelevant information [14, 15].

In studied tasks the cognitive part of tacit knowledge referred to knowledge on plant operation and processes as well as to the motives for specific behaviors or decisions. It was considered closely related to safety. Procedural and cognitive tacit knowledge were emphasized especially in technical design and mechanical maintenance. In addition, there is *social tacit knowledge* which refers to knowledge concerning organizational routines, culture and social interaction [16]. Social dimension of tacit knowledge was considered more relevant in control room. A detailed description of the content of tacit knowledge is provided in Table 24.

Table 24. The content of tacit knowledge in studied NPP units.

Technical design	Mechanical maintenance	Control room
Interpretation of authorities' standards and other regulations	Maintenance history of devices	Communication and collaboration within the control room team, field personnel and across organizational functions
Collaboration and communication with the regulator, understanding the procedures and possible procedural rules	Experience of plant operation	Operation history, history of incidents
Social networks inside the plant and within the nuclear community	Interpretation of authorities' standards and other regulations	Interpretation of authorities' standards and other regulations; situational instruction referral
Locating necessary information, identifying essential information	Understanding the reasons for safety practices	Expertise on system and process interfaces and interaction
Outage processes (contractors and technical aspects)	Location of devices	Expertise on causal relationships and combined or cumulative effects in the process
	Identifying symptoms, sensory recognizing of weak signals	Recognizing weak signals; responding to malfunctions
	Engineering skills and development of maintenance methods	Scheduling of tasks

The prerequisites for preserving and sharing of tacit knowledge in nuclear power plants

The organizational culture has an effect on the amount and quality of knowledge preserving in organizations. Many of the prerequisites for knowledge sharing are related to culture. These include the lack of communication and confidentiality, excessive trust on explicit knowledge, failure to reward people engaging in knowledge sharing, and not assign the knowledge sharing to any person or position in particular [17, 18].

The distinguishing features of tacit knowledge (see previous chapter) make it demanding to preserve. The main challenges in preserving tacit knowledge in NPPs were: 1) insufficient understanding of what tacit knowledge is, 2) simultaneous retirements of experienced experts, 3) lack of time and opportunities for collaboration to ensure knowledge sharing and 4) lack of competent instructors.

The research data showed that the prerequisites for successful sharing of tacit knowledge in studied units are divided into three categories: *The organizational factors (1)* include identifying experts and early recruitment. The organization is responsible for identifying the experts with critical knowledge and capability to instruct novices. Organizations should invest in early recruitments in order to provide enough time for collaboration and sharing of expertise. *The situational factors (2)* refer to the context and atmosphere in which the knowledge sharing takes place. Working together in the authentic work context was considered the most important way to share tacit knowledge because it stimulated the discussion about the task. The situation should allow the

novice to take responsibility and provide possibilities for interaction. *The social factors* (3) include the collaboration and interpersonal relations between the expert and novice. The attitudes towards learning and instruction should be positive. The affirmative collaboration facilitates constructive communication and useful feedback. Good interpersonal skills and understanding the learning processes improved the knowledge sharing. Attention should be paid to matching the experts and novices in terms of skills and personalities. The organizational factors (1) precede the situational (2) and social (3) factors. If the organization fails to provide enough time and support for knowledge sharing the situational and social factors lose their relevance.

Sharing tacit knowledge – methods and development

Sharing tacit knowledge is one approach to preserving tacit knowledge. Tacit knowledge develops mostly unconsciously, without written instruction or formal training [19]. Therefore, the methods for tacit knowledge sharing are based on social interaction. A literature review in the TIMANTTI project identified altogether 23 methods for sharing tacit knowledge, some of which employed a *tacitness strategy* where tacit knowledge is shared in tacit form and others a *codification strategy* where the tacit knowledge is converted into explicit form. Further, there were methods that were based on one-on-one interaction between the expert and the novice as well as methods designed for groups [see review in 22]. Since tacit knowledge should be shared through social interaction, it is highly dependable on individuals, their social networks and their willingness and capability to share knowledge. Fear of losing power or respect may cause reluctance to share knowledge. People may also be reluctant to use the knowledge of others [20, 21].

Any method adopted should be designed for the particular context or situation. The participation of employees in the selection of methods improves employee commitment and contributes to their successful implementation. In studied contexts tacit knowledge was shared in its tacit form e.g. by mentoring and occupational instruction. In addition, there were practices where tacit knowledge was shared by explicating it: e.g. retiring experts wrote manuals to gather their most critical knowledge and experts produced training materials together with the novices. However, most of these methods lacked official status, accountable person, clear objectives and evaluation practices.

Identifying the experts

In order to develop tacit knowledge sharing it is important to recognize the experts and engage them in knowledge sharing. The tacit knowledge in high reliability organizations was divided to *technical* and *contextual* knowledge. To contribute to the identification of experts these dimensions categorize the employees in four categories (Figure 141).

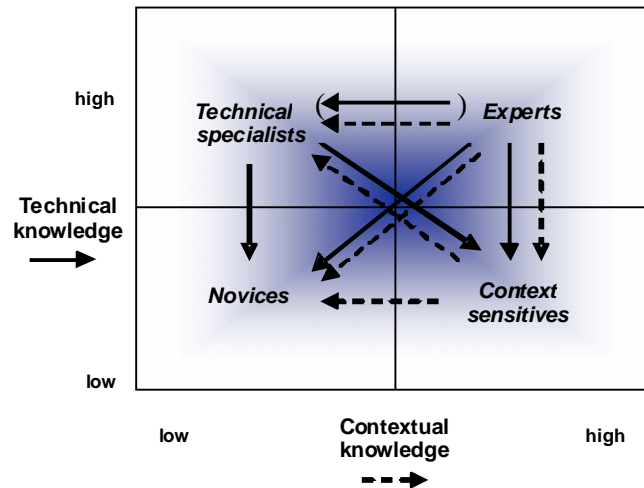

Figure 141. Classification of experts in nuclear power plants.

The experts (1) have a strong, specific technical knowledge and a profound understanding of the context that has developed through experience. It is unique and in danger to be lost when experts retire. The novices (2) are young who are not yet familiar with the context and whose technical knowledge is not very developed. However, the technical competence of novices is fresh and they are capable to learn fast. The employees who did not have experience of the context but did have technical expertise within their own special field are *technical specialists* (3). They have usually worked years in some other industry and now the challenge is to utilize their strong technical competence in the NPP context. The technical specialists can contribute to the technical tacit knowledge of the novices and context sensitives. On the other hand, the technical specialists benefit from the contextual knowledge of context sensitives and both types of tacit knowledge of the experts. The *context sensitives* (4) are employees who are newly graduated but familiar with the context. They have the potential to use their fresh technical competence in a familiar context.

Employee's position in certain category is not fixed. But being able to specify employees' expertise in a given moment helps to identify the experts who most probably have the needed understanding of the context and profound knowledge of the technical field they are specialized in. This, in turn, contributes to the planning of human resources and knowledge sharing.

Apprenticeship as a method for tacit knowledge preserving

Apprenticeship is one of the methods for preserving tacit knowledge. It had a special status as a knowledge sharing method in the control room training period of the operator training. Apprenticeship refers to an occupational learning arrangement where the expert and the apprentice perform work tasks in collaboration. The experienced

employee uses his expertise and knowledge to foster the creation of expertise and tacit knowledge of an apprentice. It doesn't mean passively or mechanistically transferring the experienced worker's tacit knowledge to the apprentice but actively facilitating his learning and knowledge development under the instruction of an expert [23]. Instead of being a teacher the expert is primarily a mentor or a guide. His role is to make thinking and work processes visible to the apprentice and stimulate and encourage the apprentice's thinking and judgement [23].

The suggested practice for apprenticeship is provided in Figure 142. It is based on the good practices recognized in practical training periods of operator training and previous studies [see e.g. 23]. Four implicit phases between the expert and the apprentice can be recognized: model, guiding, corroborating and fading. In *modeling* the apprentice forms a mental model of the task using the expert's example. In *guiding* the apprentice performs the task under the guidance of the expert. During *corroborating* the novice performs the work with the expert's support. The expert observes the work and matches

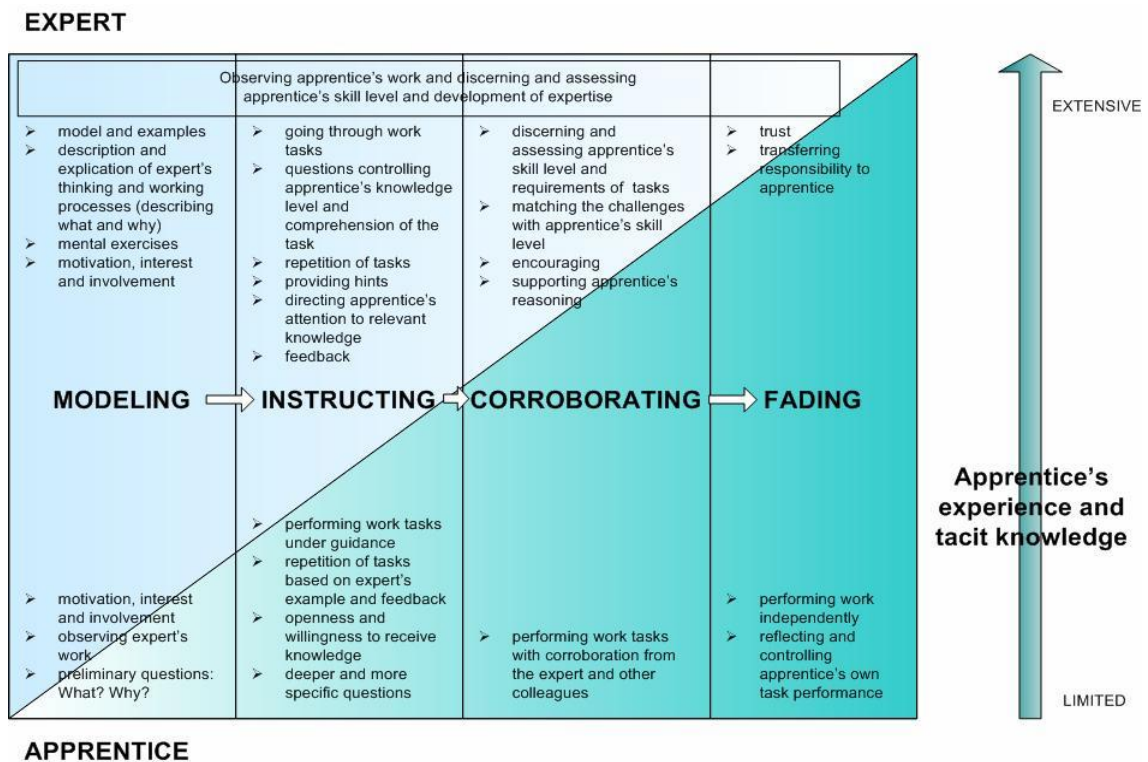

Figure 142. Model of apprenticeship process.

the challenges with the apprentice's skill level. The responsibility for performing the work is increasingly transferred to the novice in the *fading* phase. The expert's role is to evaluate the apprentice's performance until he can work independently. The phases are task-related and typically sequential, but the process is not necessarily linear. In addition the phases are not always conscious (nor need they be). Apprenticeship was seen as a

good method for sharing know-how but it was considered to require considerable resources. There were differences in the experts' abilities to instruct the novices and share their expertise. The premises supporting the implementation and use of apprenticeship were sufficient planning of the practices and commitment of both the organization and the individuals involved. On the organizational level the human resource and training departments create the framework for apprenticeship practice by setting objectives, defining roles and responsibilities and resourcing the implementation. On the individual level, the experts and apprentices engage in collaboration. They plan the particular apprenticeship period and set the objectives in more detail. Systematic feedback and evaluation practices to enable the reviewing of the results and development of apprenticeship practice are also important.

Conclusions

Identifying the role and content of tacit knowledge in a particular organizational unit or in a performance of a particular task contributes to capturing some of the critical tacit knowledge in organization. It also contributes to allocating resources for tacit knowledge sharing and knowledge management in general.

Novices cannot become experts simply by exposing them to explicit information. They need experience with the activity itself and social interaction with experienced colleagues in order to develop their expertise. Expert workers perform work tasks better and with higher quality, being more productive. They also have deeper understanding about the work context and the consequences of their actions. Observing how experts address the problems, performing tasks independently and receiving feedback are essential for novices in acquiring tacit knowledge. Experts are an enormous resource for organization and preserving knowledge.

Sharing tacit knowledge is essential way to preserve it. However, there are many methods for sharing tacit knowledge. Methods should be designed and implemented separately for each situation, bearing in mind that successful sharing of tacit knowledge between the expert and novice is not possible without practical experience and social interaction in the authentic work context. As learners and experts are expected to be active in knowledge sharing practices, they need to be involved e.g. in designing training programs.

The experts should understand their role as role models and mentors. Instructing newly recruited employees by adopting e.g. apprenticeship practices, improves also the preserving of tacit knowledge. If the experts are supported in their role as instructors and their abilities to instruct are developed, we can expect improvement also in the development of the novices' expertise. It should be noted though, that all tacit

knowledge or intuitive procedures are not useful and may even damage the task performance. Attention should also be paid to what not to share.

In the organizational level the challenge of sharing tacit knowledge relates to culture, human resource (HR) policies, knowledge management systems and communication atmosphere. Sharing and preserving knowledge should be recognized as a valuable contribution to the organization and individuals engaging in it should be rewarded. Organizational structures should provide opportunities for collaboration and cooperation aiming at preserving of tacit knowledge.

References

- [1] Nahapiet J. & Ghoshal, S. (1998) Social Capital, Intellectual Capital and the Organizational Advantage, *Academy of Management Review*, Vol. 23, pp. 242–266.
- [2] Polanyi, M. (1966) *The Tacit Dimension*, London: Routledge & Kegan Paul.
- [3] Weick, K. E. (2001) *Making Sense of the Organization*, Oxford, UK. Blackwell Publishers Ltd.
- [4] IAEA (2004) Introduction, *Proceedings in the International Conference on Nuclear Knowledge Management: Strategies, Information Management and Human Resource Development*, Saclay, September
- [5] Valle, C., Prinz, W. & Borges, M. (2002). Generation of Group Storytelling in Post-Decision Implementation Process. In the proceedings of the 7th International Conference in Computer Supported Cooperative Work in Design, on 25–27 Sept., 2002, pp. 361–367.
- [6] Evans, K & Kersh, N. (2004). Recognition of Tacit Skills and Knowledge. Sustaining Learning Outcomes in Workplace Environments. *Journal of Workplace Learning*, 16, (1/2), pp. 63–74.
- [7] Raelin, J. A. (1997). A Model for Work-Based Learning. *Organization Science*, 8 (6), pp. 563–578.
- [8] Stenmark, D. (2000). Turning Tacit Knowledge Tangible. In the proceedings of the 33rd Hawaii International Conference on System Sciences, pp. 1–9.

- [9] Johannessen, J.-A., Olaisen, J. & Olsen, B. (2001). Mismanagement of Tacit Knowledge: The Importance of Tacit Knowledge, the Danger of Information Technology and What to Do about It. *International Journal of Information Management*, 21, pp. 3–20.
- [10] Cook, S. & Brown, J. (1999) Bridging Epistemologies: The Generative Dance Between Organizational Knowledge and Organizational Knowing, *Organization Science*, Vol. 10 (4) pp. 381–400.
- [11] Johnson, B., Lorenz, E. & Lundvall, B.-Å. (2002) Why All This Fuss About Codified and Tacit Knowledge?. *Industrial and Corporate Change*, 11 (2), pp. 245–262.
- [12] Karhu, K. (2002) Expertise Cycle – an Advanced Method for Sharing Expertise, *Journal of Intellectual Capital*, Vol. 3 (4), pp. 430–446.
- [13] Hyttinen, L. & Rintala, N. (2005). The Role of tacit Knowledge and the Challenges in Transferring It – A Case Study as the Finnish NPPs. *International Journal of Nuclear Knowledge Management*, 1 (4).
- [14] Lubit, R. (2001). Tacit Knowledge and Knowledge Management: The Keys to Sustainable Competitive Advantage. *Organizational Dynamics*, 29 (4), pp. 164–178.
- [15] Smith, E. A. (2001) The role of tacit and explicit knowledge in the workplace. *Journal of Knowledge Management*, Vol. 5. No 4. pp. 311–321.
- [16] Haldin-Herrgard, T. (2000) Difficulties in Diffusion of Tacit Knowledge in Organizations. *Journal of Intellectual Capital*, Vol. 1 No. 4. pp. 357–365.
- [17] O’Dell, C. & Jackson, C. (1998). If We Only Knew What We Know: Identification and Transfer of Internal Best Practices. *California Management Review*, 40 (3), pp. 154–174.
- [18] Levin-Rozalis, M. & Rosenstein, B. (2003). A Mentoring Approach to the One-Year Evaluation Course. *American Journal of Evaluation*, 24 (2), pp. 245–259.
- [19] Schulz, M. & Jobe, L. A. (2001). Codification and Tacitness as Knowledge Management Strategies: An Empirical Exploration. *Journal of High Technology Management Research*, 12, pp. 139–165.

- [20] Jones, P. & Jordan, J. (1998) Knowledge Orientations and Team Effectiveness, *International Journal of Technology Management*, Vol. 16, Nos. 1/2/3, pp. 152–161.
- [21] Chua, A. (2002) The Influence of Social Interaction on Knowledge Creation, *Journal of Intellectual Capital*, Vol. 3, No. 4, pp. 375–392.
- [22] Rintala, N. & Kuronen, T. (2006) How to share tacit nuclear knowledge? *International Journal of Nuclear Knowledge Management*, Vol. 2, No 2, 2006, pp. 121–133.
- [23] Billett, S. (1994). Situating Learning in the Workplace – Having Another Look at Apprenticeship. *Industrial and Commercial Training*, 26 (11), pp. 9–16.

27. Potential of fire spread (POTFIS)

27.1 POTFIS summary report

Olavi Keski-Rahkonen, Johan Mangs, Simo Hostikka & Timo Korhonen
VTT

Abstract

In the POTFIS project the central goal for fire research was to improve deterministic and stochastic tools for fire-PSA. This strategic goal and its background philosophy is outlined, and main results concerning flame spread experiments and modelling, Monte Carlo simulation tools, fire detection, alarm and sprinkler systems are presented.

Introduction

Internationally the fire safety part of PSA in NPPs is not at the same scientific and technical level than most of the other parts of PSA. First US Nuclear Regulatory Commission's (NRC) paper [1] coined to three options the improving discussions during 1990's to 'pursue to develop a rulemaking for transitioning to a more risk-informed, performance-based structure for fire protection regulation of nuclear power plants': (1) develop a performance-based, risk-informed fire protection regulation, (2) develop a performance-based, risk-informed consensus standard, or (3) maintain the existing fire protection regulations and guidance. The NRC policy chosen was option 2 as a result of development of a standard [2]. An implementation proposal as a new consensus guideline was released recently for wider comments [3].

In Finland STUK asked for the goal '... to transit to more risk informed ...', but left the alternatives to scientists. Finnish research program FINNUS (1999–2002) set 1998 fire research goal: '...fast risk analysis methods ... will be developed.' [4, p. 13]. Thus already 1999 the first prototype version of our Monte Carlo calculation platform PFS was presented [4, Appendix 1, p. 23], which was later expanded to a general calculation platform [5]. Encouraged by success in creating stochastic framework for fire-PSA, Keski-Rahkonen wrote 2002 in plans of the next program SAFIR (2003–06): 'The major strategic problem during SAFIR is the ability to predict potential of fire spread in given scenarios', [6, p. 55]. From discussions with authorities and utilities a conclusion was made, the most demanding scenarios influencing CFD in our existing plants are cable fires in places containing two or more redundancies without partitions. Although the consensus guide [3], not available during the planning of SAFIR, contains new information on some of the proposed items, the major goal setting holds, and is closer to option 1 mentioned above and thus, mainly somewhat ahead of those in [3].

Main objectives

In the POTFIS project the central goal for fire research was continuing the avenue opened during the former national research programme FINNUS to develop deterministic and stochastic submodels to the same level as other branches of PSA. The major strategic problem during SAFIR was the ability to predict potential of fire spread in given scenarios. Three subprojects were started: (1) flame spread experiments on cables, (2) fire spread modelling, and (3) reliability of active and operative fire protection. Subproject (2) included also participation in International Collaborative Project to Evaluate Fire Models for Nuclear Power Plant Applications (ICP). In the later part of the project, participation in the international OECD project PRISME was added as subproject (4). The goal of the PRISME project is to provide code validation data for fire and smoke propagation from a source room to neighbouring room(s).

Main results are resumed below and work on Two Model Monte Carlo simulations is presented in the accompanied special report.

Flame spread experiments and modelling

Experiments on vertical flame spread at various scales and autoignition of thin solids were carried out to gain understanding of the mass and heat transfer processes taking place during the vertical flame spread on cable materials. A new vertical flame spread model was depicted using literature studied, by small scale experiments from subproject (1) and by direct numerical simulation (DNS) solving of Navier-Stokes equation.

Numerical simulations were carried out using LES simulation code FDS in forced 2D DNS-like mode to explore axisymmetric vertical flame spread. Examples of instantaneous gas temperatures in the simulations of three wood rods are shown in Figure 143. Calculations served primarily as numerical experiments to explore possible phenomena and specially variables needed to characterize concurrent turbulent flame spread. Secondly they served as rough tests of performance of the simulation code to be compared with experiments carried out simultaneously. The general trends of asymptotic flame spread were explored. An example of the movement of pyrolysis region along 7.8 mm thick rod of birch wood is shown in Figure 144. By averaging the time dependent heat transfer variables over the time in the co-ordinate system that moves along the pyrolysis region, we were able to find the asymptotic heat flux profiles during a vertical flame spread. An example of incident radiative heat flux is shown in Figure 145.

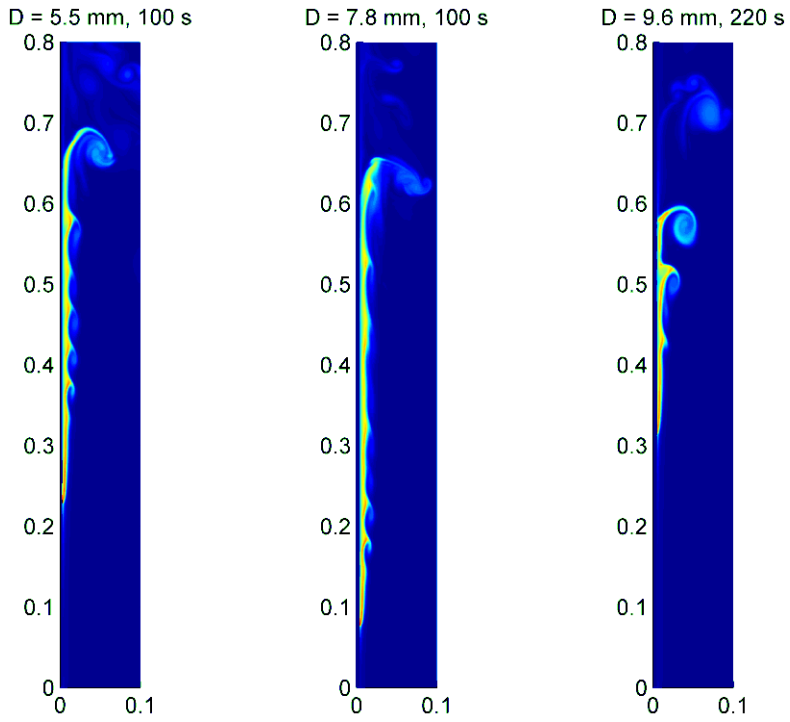

Figure 143. Instantaneous gas temperatures in three simulations.

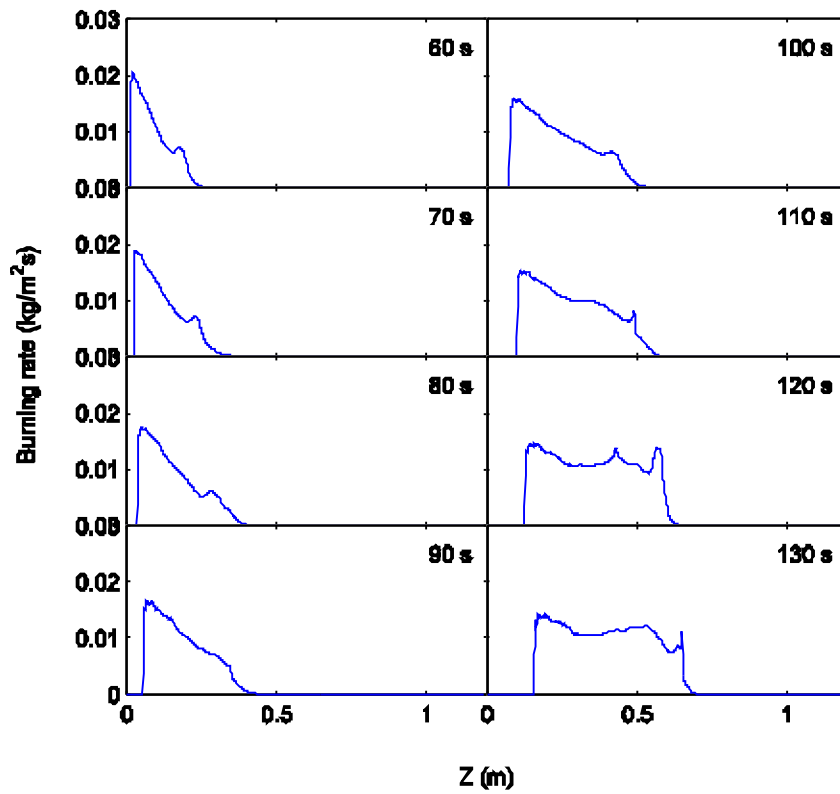

Figure 144. Movement of pyrolysis region in the simulation of 7.8 mm thick rod (P2).

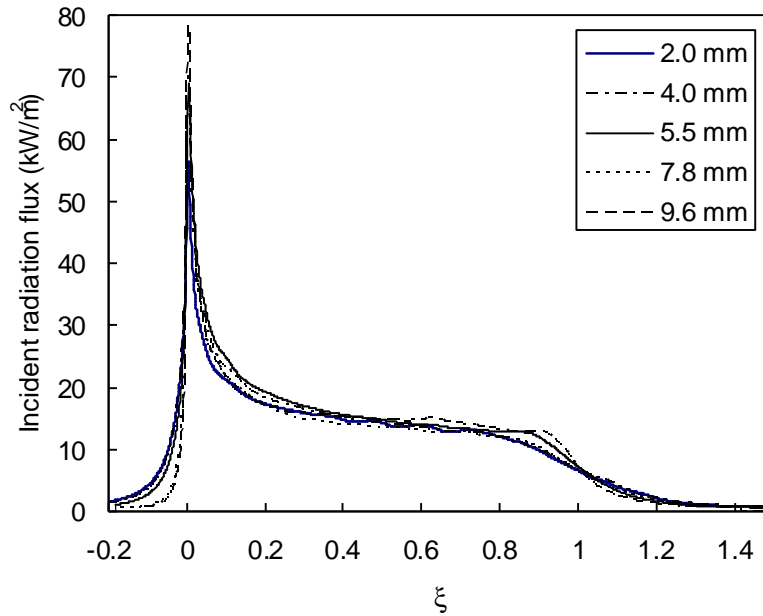

Figure 145. Time averaged profiles of incident radiative heat flux on the vertical sample.

New instruments for fire experiments

None of the existing standard fire tests are able to measure directly physical parameters, which describe flame spread on extended solids. New flame spread measuring instruments were therefore proposed: a 2 m vertical sample test rig for the measurement of flame spread velocity as a function of initial temperature, and a double cone calorimeter for energy and mass balance measurements.

The 2 m sample test rig for the new flame spread model was outlined based on modelling and measurements ideas from previous work. Physical models were written to allow quick and cheap design of the rig in the main detail. Numerical models were used for cross checking function of the selected prototype model. Series of experiments were carried out on bench scale flame spread test rig to test instrumentation, as well as to obtain data to be compared with DNS-like simulations of flame spread. Results showed the concept is ready for physical construction, which was started in 2006. A sketch of the new test rig is shown in Figure 146a.

New forms of cone calorimeter needed for energetics of flame spread were also outlined, and modelled analytically. Series of experiments were carried out to assess the practicability of the new double cone calorimeter concept. The results showed that the method is practical and realizes adiabatic boundary condition on the central surface of the vertical sample. A photograph from a double cone calorimeter experiment is shown in Figure 146b.

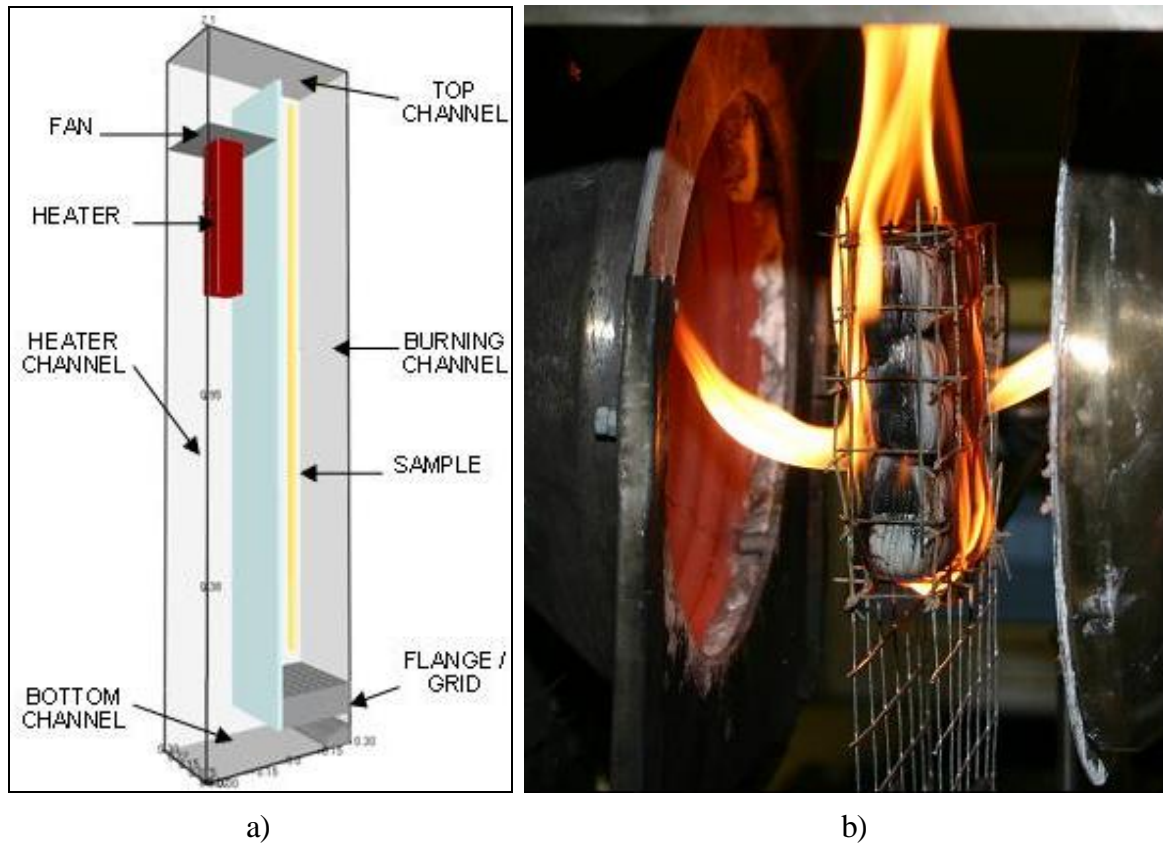

Figure 146. a) 2 m vertical sample test rig for flame spread velocity as a function of initial temperature. b) double cone calorimeter experiment on wood sample for energy and mass balance.

Monte Carlo calculation tools

In the previous research projects concerning the fire safety of Finnish nuclear power plants, a Monte Carlo tool called Probabilistic Fire Simulator (PFS) was developed [5]. PFS can be used for the computation of the distributions of fire model output variables and the sensitivities of the output variables to the inputs. In the current project, a new technique was developed for the use of two different fire models in the same Monte Carlo simulation [6]. The Two-Model Monte Carlo (TMMC) technique provides a computationally effective means to improve the accuracy of the fast but inaccurate models, using the results of the more accurate but computationally more demanding models. The technique was tested in three scenarios: approximation of analytic functions, calculation of a ceiling jet temperature and a simulation of a simple room fire. Practical applications included the simulations of component failure time distributions and probabilities in NPP relay and cable rooms.

Reliability of fire detection and alarm systems

A literature review of reliability data of fire detection and alarm systems was made giving rough estimates of some failure frequencies [8]. No theoretical or technical articles on the structure of reliability models of these installations were found. Inspection records of fire detection and alarm system installations by SPEK were studied, and transferred in electronic data base classifying observed failures in failure modes (59) and severity categories (3) guided by freely written records in the original data. The results are presented in tabular form. A small sample of installations was collected, and number of components in them was counted to derive some distributions for determination of national populations of various components based on known total amount of installations. From NPPs (Loviisa, Olkiluoto and Barsebäck) failure reports were analysed and observed failures of fire detection and alarm systems were classified by severity and detection mode. They are presented in tabular form for the original and new addressable systems. Populations were counted individually, but for all installations needed documents were not available. Therefore, presented failure frequencies are just first estimates.

Reliability of sprinkler systems

A literature survey from open sources worldwide of available reliability data on sprinkler systems was carried out [9]. Since the result of the survey was rather poor quantitatively because nuclear power plants present a rather small device population, data needed for estimating of reliability of sprinkler systems were collected from available sources in Finnish nuclear and non-nuclear installations. Population sizes on sprinkler system installations and components therein as well as covered floor areas were counted individually from Finnish nuclear power plants. From non-nuclear installations corresponding data were estimated by counting relevant things from drawings of 102 buildings, and plotting from that sample needed probability distributions. The total populations of sprinkler systems and components were compiled based on available direct data and these distributions. From nuclear power plants electronic maintenance reports were obtained, observed failures and other reliability relevant data were selected, classified according to failure severity, and stored on spreadsheets for further analysis. A short summary of failures was made, which was hampered by a small sample size. From non-nuclear buildings inspection statistics from years 1985-1997 were surveyed and observed failures were classified and stored on spreadsheets. Finally, a reliability model was proposed based on earlier formal work, and failure frequencies obtained by preliminary data analysis of this work. For a model utilising available information in the non-nuclear data body, it has to be analysed more comprehensively, than was possible in these studies.

Participation in OECD PRISME project

Fire simulations of the PRISME-SOURCE tests were performed using the development version of FDS 5. The simulations were carried out related to but outside PRISME aiming to guidance for design of experiments and to validate developed models. Results were transmitted to and from PRISME in project meetings by a VTT representative, who transmits working and travel reports to interested parties in Finland.

Conclusions

Fire-PSA models and tools have been improved and proposed concerning fire spread, experimental methods, numerical methods, and active fire protection.

References

1. SECY-98-058, Development of a risk-informed, performance-based regulation for fire protection at nuclear power plants, US Nuclear Regulatory Commission, Commission Paper, March 26, 1998.
2. NFPA 805, 2001. Performance-Based Standard for Fire Protection for Light Water Reactor Electric Generating Plants. National Fire Protection Association, Quincy, MA.
3. EPRI/NRC-RES, Fire PRA Methodology for Nuclear Power Facilities, EPRI TR-1008239 and NUREG/CR-6850, Electric Power Research Institute (EPRI), Palo Alto, CA and U.S. Nuclear Regulatory Commission, Rockville, MD, 2004. Volume 1: Summary and Overview, Volume 2: Detailed Methodology.
4. FINNUS, 2000. The Finnish Research Programme on Nuclear Power Plant Safety 1999-2002, Annual Report 1999, Halti-1/00, VTT Energy, Espoo 2.2.2000. 121 p.
5. Hostikka, S. & Keski-Rahkonen, O. 2003. Probabilistic simulation of fire scenarios, Nuclear Engineering and Design, 224, pp. 301–311.
6. Hostikka, S., Korhonen, T. & Keski-Rahkonen, O. Two-model Monte Carlo simulation of fire scenarios. Proceedings of the 8th International Symposium on Fire Safety Science. Beijing, China, 18 - 23 Sept. 2005. Gottuk, D. & Lattimer, B. (eds.). International Association of Fire Safety Science, pp. 1241–1253.
7. Puska, E. K. (ed.). 2003. SAFIR, The Finnish Research Programme on Nuclear Power Plant Safety. Annual Plan 2003, Project Report PRO1/P7007/03, 30.05.2003. VTT Processes, Espoo. 83 p.

8. Nyssönen, T., Rajakko, J. & Keski-Rahkonen, O. 2005. On the reliability of fire detection and alarm systems. Exploration and analysis of data from nuclear and non-nuclear installations. VTT Working Papers 18. VTT, Espoo. 62 p. + app. 6 p. ISBN 951-38-6569-X. <http://virtual.vtt.fi/inf/pdf/workingpapers/2005/W18.pdf>.
9. Rönty, V., Keski-Rahkonen, O. & Hassinen, J.-P. 2004. Reliability of sprinkler systems. Exploration and analysis of data from nuclear and non-nuclear installations. VTT Working Papers 15, VTT, Espoo. 89 p. + app. 9 p. ISBN 951-38-6566-5. <http://virtual.vtt.fi/inf/pdf/workingpapers/2004/W15.pdf>.

27.2 Two-Model Monte Carlo Simulation of Fire Scenarios

Simo Hostikka, Timo Korhonen & Olavi Keski-Rahkonen
VTT

Abstract

A risk analysis tool called Probabilistic Fire Simulator (PFS) is developed for the computation of the distributions of fire model output variables and the sensitivities of the output variables to the inputs. In this work, a new technique is developed for the use of two different fire models in the same Monte Carlo simulation. The Two-Model Monte Carlo technique provides a computationally effective means to improve the accuracy of the fast but inaccurate models, using the results of the more accurate but computationally more demanding models. The technique is tested in two scenarios: calculation of a ceiling jet temperature and a simulation of a simple room fire, and finally applied on NPP relay room fire.

Introduction

The numerical simulation of fires can be used to predict the consequences of prescribed fire scenarios at NPPs. When used as a part of the PSA process, the target function may be, for instance, a failure of a component of a redundant system located in the same physical space with the system catching fire. Such an analysis should not be limited to the most probable fire, but all the possible fires that can take place in the room of interest. The probability of component failure due to the fire should be calculated using Monte Carlo technique, where a large number of samples is randomly chosen from the input space and mapped through the system into the target distribution. Although Monte Carlo as a technique is almost 60 years old [1], its use in fire simulations has been prohibitively expensive. With modern computers the situation has changed, and the tools described here have been already applied to engineering problems. In the previous research projects concerning the fire safety of Finnish nuclear power plants, a Monte Carlo tool called Probabilistic Fire Simulator (PFS) was developed [2]. The tool was applied to fires in a cable tunnel and an electronics room. The tool allows the simulation of fire scenarios using various fire models, including two-zone model CFAST [3] and Fire Dynamics Simulator [4]. The main outcomes of the tool are the distributions of the selected result variables, for example component failure time, and the sensitivities of the output variables to the input variables, in terms of the rank order correlations.

The numerical simulation of the complicated physical processes is always trading between the desired accuracy of the results and the computational time required. Quite often, the same problem can be tackled by many different models with different physical and numerical simplifications. A technique is therefore needed, which can combine the results of the different models in a computationally effective way. A new technique, based on an intuitive approach, is proposed here. The technique allows the use of two different models in Monte Carlo simulation, and is therefore called Two-Model Monte Carlo (TMMC) [5]. In the current work, the TMMC method is first tested in a simple scenarios. In a realistic NPP application, a relay room fire is simulated using two different FDS models.

Two-Model Monte Carlo simulation

During the probabilistic safety assessment, one typically needs to estimate the probability that a certain component or system is damaged during a fire. The development of fire and the response of the components under consideration are assumed to be fully deterministic processes where the same initial and boundary conditions always lead to the same final state. The probability of an event can now be calculated using Monte Carlo simulations where input variables are sampled randomly from the given distributions. Latin Hypercube sampling [6] can be used to generate samples from all ranges of the possible values, thus giving insight into the tails of the probability distributions.

We assume that we have two numerical models A and B, which can calculate physical quantity $a(x,t)$ depending on a parameter x and the time t . In our analysis, x is considered to be a random variable from a random space Ω . The model B is more accurate than the model A, but the execution time of model B is longer than model A. The models are used to get two estimates of the time series: $\tilde{a}^A(x,t)$ and $\tilde{a}^B(x,t)$. The developed Two-Model Monte Carlo (TMMC) technique is based on the assumption that the results of the model A, at any point x of the random space, can be corrected by multiplying them with scaling function, which is the ratio of model B time series to model A time series at some point \mathbf{x}_s in the vicinity of the current point x . The points \mathbf{x}_s are called scaling points.

In the beginning of the simulation, the random space is divided into distinct scaling regions. Scaling function is then calculated for each region

$$\Phi(\mathbf{x}_s, t) = \frac{\tilde{a}^B(\mathbf{x}_s, t)}{\tilde{a}^A(\mathbf{x}_s, t)} \quad (1)$$

where \mathbf{x}_s is the mid-point of the scaling region Ω_s . During the Monte Carlo, the result of the model A is multiplied by the scaling function corresponding to the closest scaling point, to get the corrected times series $\tilde{a}^{AB}(\mathbf{x}, t)$

$$\tilde{a}^{AB}(\mathbf{x}_s, t) = \Phi(\mathbf{x}_s, t) \tilde{a}^A(\mathbf{x}_s, t), \quad \mathbf{x}_s \in \Omega_s \quad (2)$$

The result of the Monte Carlo simulation is usually not the time series itself, but some scalar property derived from the time series. A typical result is the time to reach some critical value.

Results and discussion

Ceiling jet temperature

Two models were used to predict the ceiling jet temperature under the ceiling of a 10 m × 10 m × 5 m (height) room with a fire in the middle of the floor. The room had one, 2.0 m × 2.0 m door to ambient. The fire heat release rate was of t^2 -type with a random, uniformly distributed growth time t_g . Two scalar results were studied. The scalar result $b(t_g)$ was the ceiling jet temperature at time = 30 s. The scalar result $c(t_g)$ was the time to reach a critical temperature of 100°C in the ceiling jet.

Alpert's ceiling jet model [7] was used as Model A and two-zone model CFAST as Model B. We simply assumed that CFAST is more accurate than Alpert's model, whether this is true or not in reality. The random space was divided into three scaling regions. 1000 samples were calculated using both models. The predicted cumulative distributions of $b(t_g)$ are shown in the left part of Figure 147. At all values of t_g , CFAST predicted higher temperatures than Alpert's model. TMMC distribution was very close to the CFAST result, but had small discontinuities at the boundaries of the scaling regions. The right hand side of Figure 147 shows the cumulative distributions of $c(t_g)$. As can be seen, TMMC scaling very accurately captured the shape of the CFAST distribution.

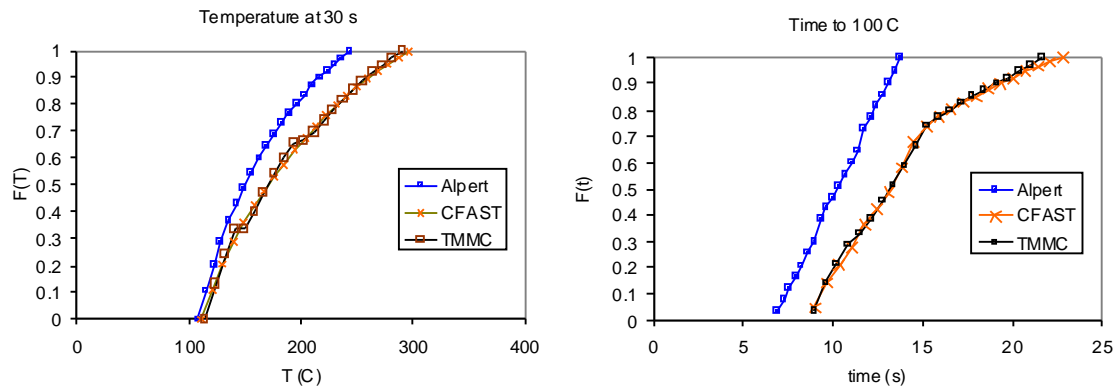

Figure 147. Distributions of temperature at time = 30 s (left) and time to reach 100°C (right).

In this example, TMMC was able to accurately reproduce the results as a full CFAST Monte Carlo, within a fraction of time required for the full CFAST Monte Carlo. Assuming that the execution times for Alpert's model and CFAST are 1.0 and 10 CPU seconds, respectively, and that the scaling overhead time is very small, the TMMC simulation time would be 1030 seconds in total. For comparison, the full CFAST Monte Carlo would take 10,000 seconds (2.8 hours).

Simple Room Fire

In this scenario, CFAST and FDS models were used for the fire modelling. For the evaluation of the TMMC results, a full Monte Carlo using FDS model was performed. Therefore, the size of the room was chosen very small in order to keep the simulation times short. A schematic picture of the room is shown in Figure 148. The fire source was a rectangular burner at the floor level. The co-ordinates and surface area of the fire source were random variables. A list of the random variables is given in Table 25. The target functions were the gas temperature and heat detector activation time under the ceiling, left from the concrete beam. For gas temperature, the time to reach 200°C was monitored.

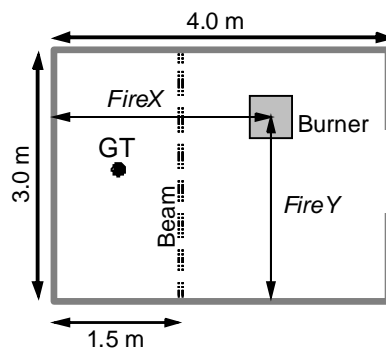

Figure 148. The geometry of the room fire scenario. GT shows the location of the heat detector and the gas temperature measurement point 5 cm under the ceiling.

CFAST was used as the model A and FDS as the model B. In CFAST, two virtual rooms were used by splitting the room at the beam location. In FDS, a constant grid cell size of 0.10 m was used. Before the actual TMMC application, simulations using only CFAST and only FDS were carried out. With 1000 realisations with both models, the final distributions were well converged.

Table 25. A list of random variables in the room fire example.

Variable	Units	Distribution	Min	Max	Mean	Std.dev.
BeamHeight z_B	m	Uniform	0.0	0.6		
GrowthTime t_g	s	Uniform	60.0	180.0		
Area	m ²	Normal	0.2	1.5	0.80	0.60
FireX	m	Uniform	0.0	4.0		
FireY	m	Uniform	0.0	3.0		

The effect of the number of TMMC scaling points was studied by using different ways to divide the random space. The number of scaling points varied from one to 32. A comparison of predicted probability distributions for the time when the gas temperature reached 200°C is shown in Figure 149. The numbers in the parantheses refer to the number of scaling points. The overall probability was 63.5% according to CFAST, while the FDS results lead to a final probability of 90.7%. The division of the random space had a clear effect on the accuracy of the TMMC distribution. If the division was made based on the information of the relative importance of the random variables, the higher number of scaling points generally improved the accuracy. However, if the scaling points were chosen without any prior information of the importance, the results did not improve as much as one might have expected, as was shown in the case TMMC(32B).

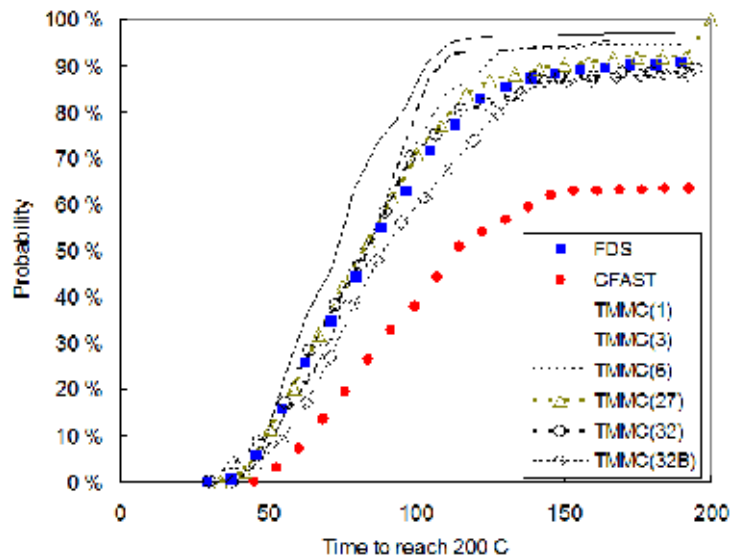

Figure 149. Predicted probability distributions of time to reach 200°C.

NPP Relay Room Fire

As a real scale application, a fire in a relay room containing about 200 electronics cabinets was studied. The room contains cabinets of two redundant sub systems separated by physical distance. The target of the simulation was the time dependent component failure probability of the second sub system, when the fire ignites in a cabinet being part of the first sub system. Based on the earlier studies, it was known that the spreading of the fire inside the ignition cabinet determines the conditions in the room in the early phases of the fire, and acts as a boundary condition for the further spreading of the fire. Due to the high uncertainty associated with the numerical flame spread predictions, the development of this early fire was described by simple analytical model [8]. The total combustible mass per cabinet determines the overall burning time and was treated as a random variable, as well as growth rate and maximum level of the heat release rate. The location of the ignition cabinet was also chosen randomly.

The simulations were performed using version 4.01 of FDS. An overview of the FDS model of the relay room is shown in Figure 150. In this application, Model A was a FDS model with relatively coarse computational mesh and Model B was FDS with fine computational mesh. 1000 simulations were performed using model A and 24 simulations using model B. Each simulation of model A took about 24 h and model B simulation about 5 days on one CPU of modern workstation. The simulations were performed on a group of 8 workstations with 2 CPUs on each computer. As an example of the results, the gas temperature field at height 2.40 m at time = 700 s is shown in Figure 151. The effect of the ventilation can be seen on the left side of the room, where fresh air is blown into the room from the air channels.

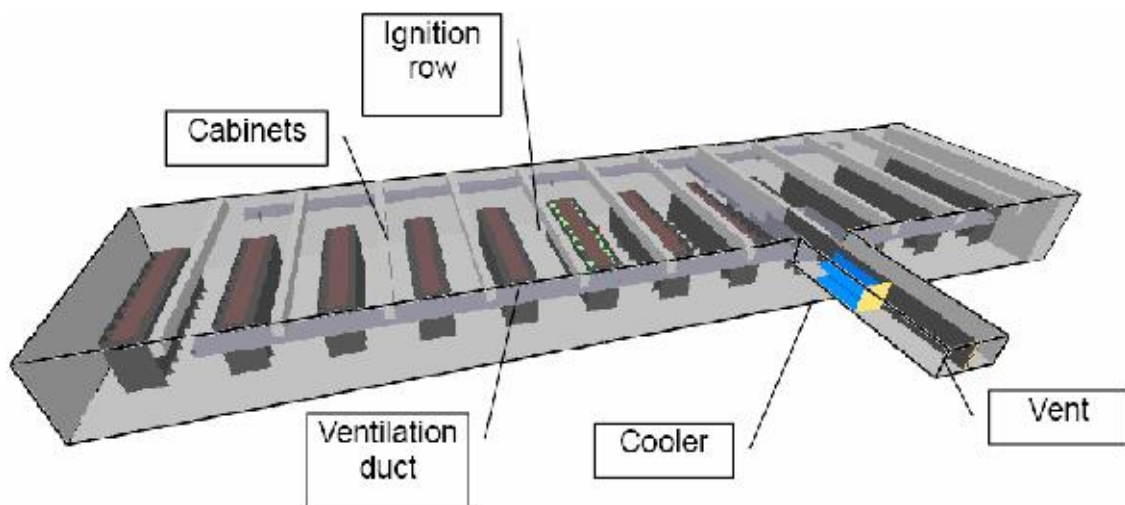

Figure 150. An overview of the FDS model of the relay room.

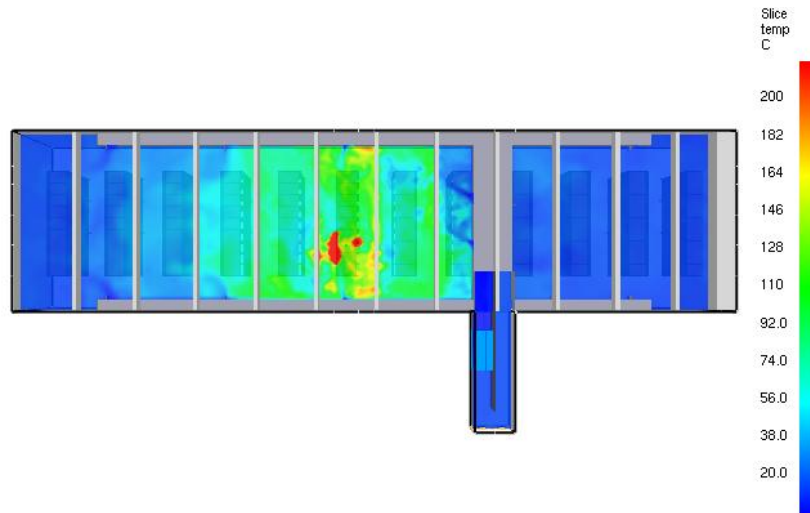

Figure 151. Instantaneous temperature at height $z = 2.4$ m, 700 s after the ignition.

A list of random variables is shown in Table 26. HRR Growth rate was the growth time coefficient of the ignition cabinet HRR curve. Row and column numbers defined the location of the ignition cabinet inside the room. Cooler power was varied to find out the importance of the room cooling. The uncertainty related to the material properties of the cabinet contents was described as the variation of the ignition temperature. This feature was only applied to the ignition of the neighboring cabinets.

The failure times of the critical components were calculated for three different critical temperatures: 80°C, 100°C and 120°C. For the calculation, the target temperature was chosen to be the maximum of the cabinets in both neighboring rows. The cumulative distributions of the failure times are shown in Figure 152. The final probabilities corresponding to the three critical temperatures are 0.41, 0.091 and 0.006, and the average values of the failure times are 23, 24 and 25 minutes. The uncertainty of the probability curves comes from both the statistical uncertainty and the uncertainty of the physical modeling. Here, the modeling uncertainty is the dominating source of error. An estimate for the uncertainty of the given probabilities is ± 0.1 .

Table 26. List of random variables in the relay room scenario.

Variable	Distribution type	Mean	Min	Max	Units	N_{TMMC}
HRR Growth time	Uniform(750,2000)	1375	750	2000	s	3
Row number	Discrete(1,2,3,4,5,6)					1
Column number	Discrete(1,2,3,4,5,6,7,8,9)					1
Combustible mass	Uniform(20,60)	40	20	60	kg	2
Cooler power	Uniform(0,96)	48	0	96	kW	1
Ignition temperature	Uniform(310,350)	330	310	350	°C	2
Maximum HRR of a cabinet	Uniform(200,450)	325	200	450	kW	2

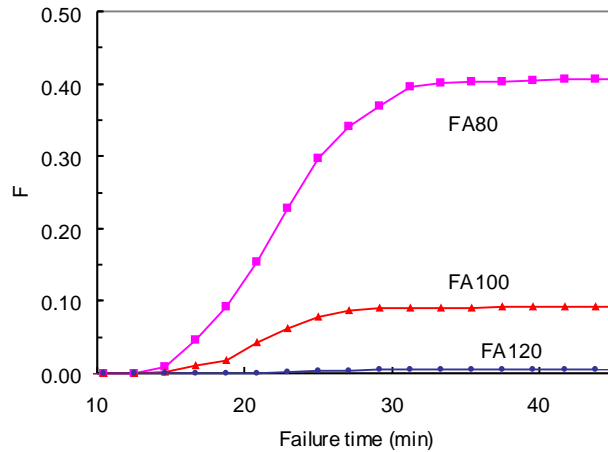

Figure. 152. Cumulative distribution of the target failure times. The three curves correspond to critical temperatures 80, 100 and 120 °C.

The sensitivity of the failure time FA80 to the input variables was studied by calculating the rank order correlations, shown in Figure 153. As can be seen, the HRR growth time is the dominating input. The physical location in the room seems to have some effect, possibly due to the asymmetric ventilation conditions.

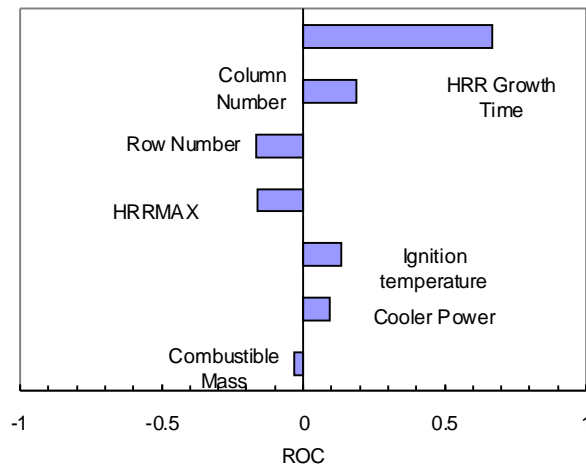

Figure 153. Sensitivity of the failure time (FA80) to the inputs.

The manual fire fighting procedures was not included in the simulations. However, the probability of successful fire fighting studied by calculating the available operation time of the fire fighters by subtracting the detection time from the failure time (FA80). The distribution of the available operation time is shown in Figure 154. The average available operation time is 16.7 min and in 2.7 % of the fires, the available time is less than 10 min. A closer look at the simulation results data showed that the smallest available operation times are caused by the late fire detection, not early failure. The fire fighters' ability to find the fire source is strongly affected by the loss of visibility in smoke. In the same figure, the distribution of the available visible time is also shown. It

is clear, that the fire fighters will have difficulties finding the fire source unless they can enter the room within six minutes from the fire detection.

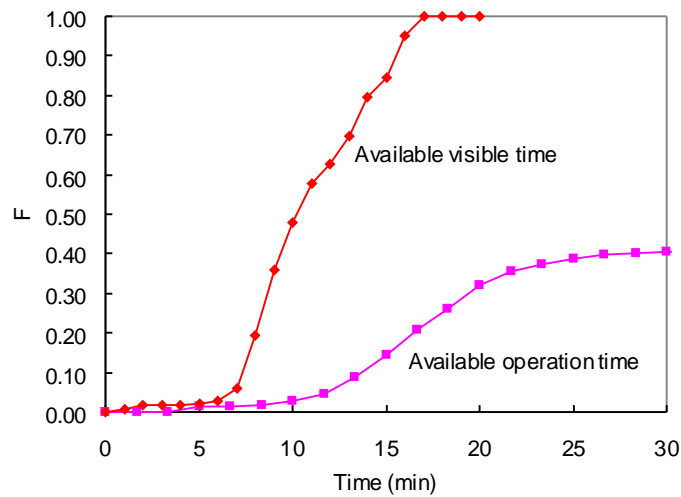

Figure 154. Cumulative distributions of the available operation time and available visible time.

Conclusions

A new technique was developed that can be used to improve the accuracy of the Monte Carlo simulation. Two-Model Monte Carlo is a computationally affordable technique to utilize advanced simulation techniques like CFD in the probabilistic safety assessment of large systems. In practical applications, the results of the simple but defective simulation models can be corrected by scaling them with the results achieved from an order of few tens of simulations with the more advanced model. A good accuracy can be achieved if the existing information on the relative importance of the random variables is used to efficiently place the scaling points. If such information is not available, or is not reliable, the random space must be divided uniformly in all dimensions, and the number of required scaling points may become very high.

The new model has already found applications in the computation of the fire induced damage probabilities in large and complicated compartments like the switchgear rooms of the nuclear power plants. In these applications, we have demonstrated that an alternative for the use of two different computer codes is the modelling of the same scenario with one code but two different discretizations.

References

- [1] Metropolis, N. & Ulam, S. The Monte Carlo Method, *Journal of the American Statistical Association*, 44 (1949) 247, pp. 335–341.
- [2] Hostikka, S. & Keski-Rahkonen, O. Probabilistic simulation of fire scenarios, *Nuclear engineering and design*, 224 (2003) 3, pp. 301–311.
- [3] Jones, W. W., Forney, G. P., Peacock, R. D. & Reneke, P. A. Technical Reference for CFAST: An Engineering Tool for Estimating Fire and Smoke Transport, National Institute of Standards and Technology NIST TN 1431, Gaithersburg, MD, 2000. 190 p.
- [4] McGrattan, K. B., Baum, H. R., Rehm, R. G., Hamins, A., Forney, G. P, Floyd, J. E, Hostikka, S. & Prasad, K. Fire Dynamics Simulator (Version 3) – Technical Reference Guide, National Institute of Standards and Technology, Gaithersburg, MD, 2002, NISTIR 6783, 2002 Ed. 46 p.
- [5] Hostikka, S., Korhonen, T. & Keski-Rahkonen, O. Two-model Monte Carlo simulation of fire scenarios. Proceedings of the 8th International Symposium on Fire Safety Science. Beijing, China, 18–23 Sept. 2005. Gottuk, D. & Lattimer, B. (eds.). International Association of Fire Safety Science. Pp. 1241–1253.
- [6] McKay, M. D., Beckman, R. J. & Conover, W. J. A comparison of three methods for selecting values of input variables in the analysis of output from a computer code, *Technometrics*, 21(2) (1979), pp. 239–245.
- [7] Drysdale, D. *An Introduction to Fire Dynamics*. Wiley-Interscience, Chichester, 1999. Second Edition. Pp. 140.
- [8] Mangs, J. & Keski-Rahkonen, O. Full scale fire experiments on electronic cabinets II. Espoo, Technical Research Centre of Finland. 1996. VTT Publications 269. 48 p. + app. 6 p.

28. Principles and practices of risk-informed safety management (PPRISMA)

28.1 PPRISMA summary report

Jan-Erik Holmberg
VTT

Abstract

The PPRISMA project deals with both risk-informed decision making and methods for risk assessment. Approaches have been developed to support maintenance and operability planning, management of fire situations and safety classification. Methods for the reliability assessment of computer-based systems and long term mission reliability analysis have been developed. In addition, the research activities are carried through international co-operation.

Introduction

Risk-informed safety management means use of information from probabilistic safety assessment (PSA) to support decision making in various contexts. In nuclear safety regulation, risk-informed applications are an option to present licensing practices. The Finnish regulatory PSA guide calls for risk-informed assessment of safety classification, in-service-inspection programmes, in-service-test intervals and allowed outage times of equipment. Similarly, maintenance and surveillance programs, training of personnel, working out of procedures and ways of acting can be assessed. PPRISMA project deals with both developments of risk-informed methods and specific PSA modelling issues related to uncertainties that can hinder implementation of risk-informed applications.

Main objectives

The main objectives are to develop risk-informed decision making methods integrating results from risk and reliability analyses with other expertise in the problem domain, to develop assessment methods for plants' operation and maintenance to enhance planning of activities and acting in situations, to develop methodologies in the problem areas of PSA, to advance skills in risk analysis, to assure the competence transfer to the new generation and to participate in international co-operation.

Risk-informed decision making

A study was made of status of risk-informed decision making at Finnish and Swedish nuclear power plants and safety authorities [1]. In Finland, the regulatory PSA guide requires the licensee to use the PSA in support of licensing of new NPPs and of resolving safety issues at operating NPPs. The regulatory body STUK has performed several pilot studies to facilitate risk-informed applications. In Sweden, the use of PSA is less mandatory than in Finland. In both countries, the nuclear power plants have applied PSA in many areas. The main problems related to the applications are: quality of PSA, communication between parties involved, and acceptance of risk-informed decision making. The study presents a decision theoretic framework to verify that most important principles have been followed to a reasonable extent.

Target values for PSA results, both for core damage frequency and for radioactive releases, are in use in most countries having nuclear power plants. In a Nordic project the history and experience from the use of the safety goals are clarified [2]. Utilities and safety authorities in Finland and Sweden were interviewed and the results will be compiled to a report. The work will be continued in an international context towards guidance on problems identified, e.g., ambiguities in definitions of safety goals and impact of uncertainties in PSA results in the use of safety goals.

Maintenance and operability strategies

The focus in human reliability analysis has traditionally been on human performance in disturbance conditions. On the other hand, human maintenance and planning failures and design deficiencies, remained latent in the system, have an impact on the severity of a disturbance, e.g. by disabling safety-related equipment. Especially common cause failures (CCFs) can affect the core damage risk to a significant extent. The topic has been addressed in Finnish studies, where experiences of latent human errors have been searched and analysed in detail from the maintenance history in the Loviisa and Olkiluoto NPPs. The most errors related to maintenance stem from modifications, preventive maintenance and repairs during the refuelling and maintenance outage periods [3]. Figure 155 shows the distribution of the fault detection states of human common cause failures originated from outages. The studies suggest improvements in planning the coverage of installation inspections and testing after small and ordinary modifications and complex or intrusive maintenance work actions.

A process model for planning a risk informed and cost-effective maintenance programme has been constructed [4]. The model covers better the risk management objectives and criteria such as risk importance, avoidance of production losses and CCFs and the operability verification than the present streamlined RCM (reliability

centered) maintenance analysis and planning methods. This model development was supported by the trial studies on application of the Burden to Importance Ratio (BIR) for resource allocation of condition based maintenance of a safety related system and analysis of the barriers against the analysed human CCFs of the Loviisa plant [5, 6].

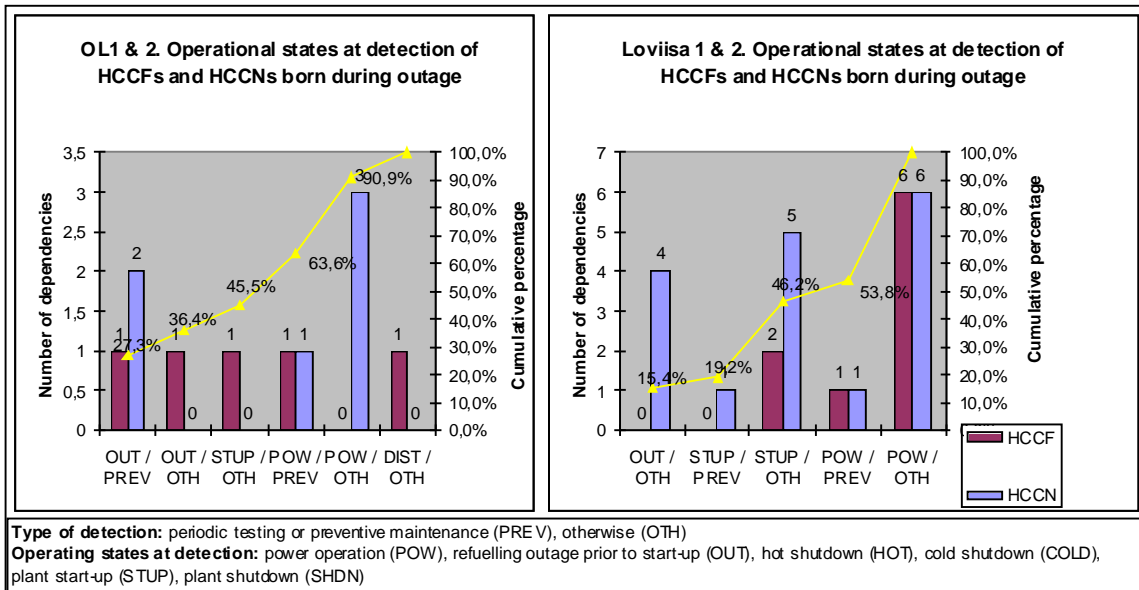

Figure 155. Distribution of fault detection states of human common cause failures originated from maintenance outages. (HCCF = critical human common cause failure, HCCN = non-critical human common cause failure).

Risk-informed ways of management of fire situations

VTT has developed a method for supporting the management of fire situations in nuclear power plants [7–9]. The approach developed is presented in a separate article of this SAFIR final report.

Risk-informed categorisation of systems, structures and components

Risk-informed categorization is based on utilising PSA information in a consistent way to select most cost-effective methods to control risk associated with systems, structures and components [10]. It provides a complementary method to the safety classification used in nuclear power plants.

Figure 156 shows a grouping of components into three risk classes: 1) High conditional core damage probability, low unavailability, 2) medium conditional core damage probability, medium unavailability and 3) low conditional core damage probability, high unavailability. The purpose of this risk classification is to evaluate the balance of safety

in the nuclear power plant. Balance means that there should be enough defense-in-depth for mitigating initiating events (diversity and redundancy in safety functions) in relation to the initiating events frequencies.

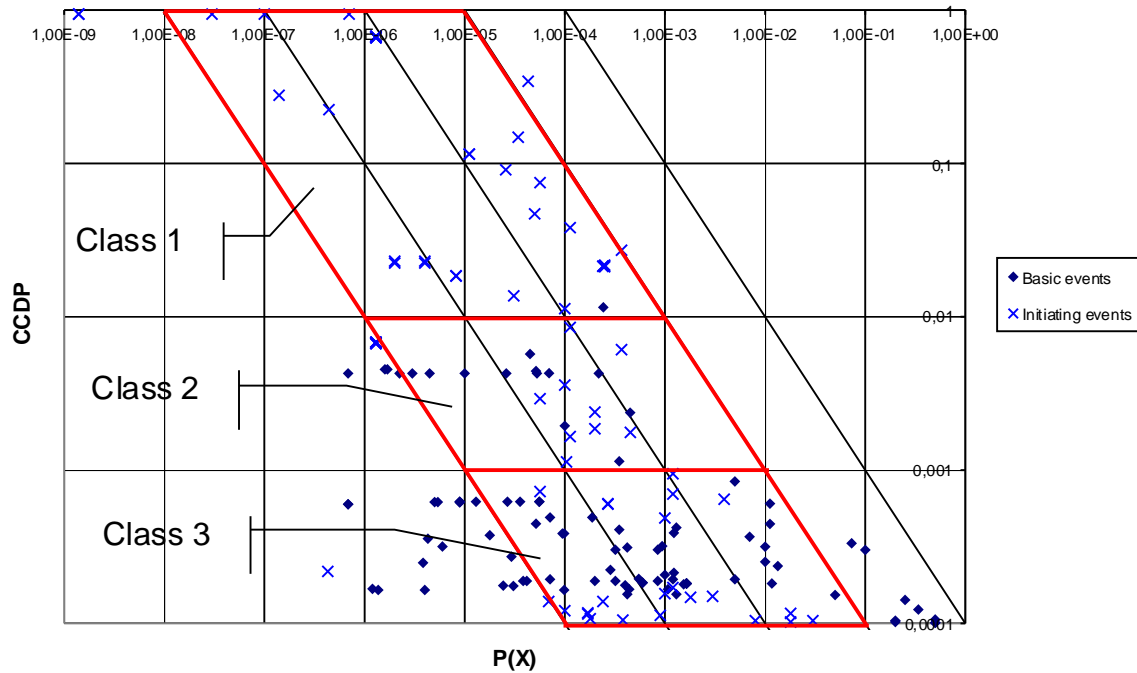

Figure 156. Classification of the components and initiating events in Loviisa 1. CCDP = Conditional core damage probability, $P(X)$ = Component unavailability. Risk classes: 1) high CCDP – low $P(X)$, 2) = medium CCDP – medium $P(X)$, 3) = low CCDP – high $P(X)$.

Reliability of computer-based systems

Computer-based systems have an increasing influence to the operation of nuclear power plants. With programmable technology it is fairly straightforward to implement the functionality required for controlling different processes of a plant. On the other hand, at the same time programmable technology is an easy way of introducing unwanted complexity and unreliability to the instrumentation and control systems. For several years a reliability estimation methodology based on Bayesian inference has been developed at VTT [11–12]. In PPRISMA project the methodology is applied from PSA point of view [13]. With the methodology justified quantitative reliability estimates for safety functions implemented on programmable technology will become available.

The reliability estimation method was applied and developed in a form of case studies. In the case study, software reliability of a motor protection relay was estimated. The case study was an in-kind contribution of ABB Substation Automation and the expert judgements of the different developer groups of the relay were applied as the prior

estimate of the failure probability of the relay. The prior estimate was built in a special expert judgement process where the technical documentation of the relay was reviewed and uncertainties within and between the development groups were recognized and estimated. The prior reliability estimate given by the experts was updated to posterior estimate with available reliability data from relay testing and operational experience.

In 2005, VTT acted as a host to IAEA technical meeting on Implementing and Licensing Digital I&C Systems and Equipment in NPPs. The IAEA Technical Working Group on the same issue (TWG – NPPCI) is preparing a TECDOC on this topic.

In the final year, methods and issues of software reliability prediction, with focus on finding the likelihood function of the reliability of software in operational use have been explored [14]. Also an overview of the SAFIR-projects PPRISMA/RECOM, ASDES and QETES focusing on different aspects of software reliability has been prepared.

Long term mission reliability assessment

For more realistic modelling of some long-term PSA scenarios, it is required to account for dynamic behaviour of analysed systems. This need has emerged, e.g. in connection to shutdown PSA and level 2 PSA. Generally, these long time missions have been analysed superficially or excluded totally. A Markov model based modelling tool was developed [15]. Recovery of failed components, logistic delay in repair and time dependent behaviour of the time system tolerates failed components are taken into account. Numerical examples are presented to demonstrate dynamical behaviour if systems with one to four components (see Figure 157).

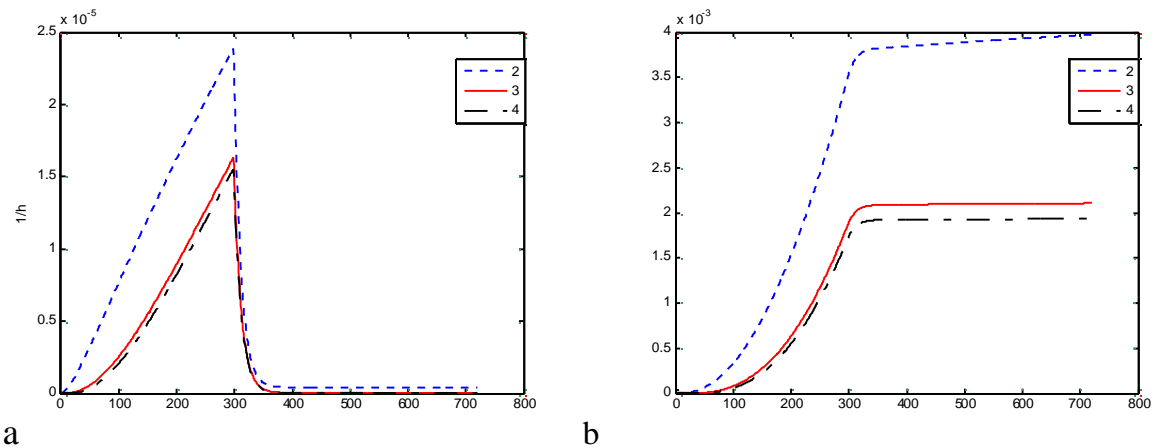

Figure 157. a) Hazard rate and b) system failure probability of example systems with 2, 3 or 4 components, logistic delay in repair was 300 h, mission time 720 h.

Applications

The results of the PPRISMA project have direct applications in risk-informed decision making both at nuclear safety authorities and utilities. The approaches developed in analysis of maintenance history information have been used for analysis, learning and prevention of errors and enhancement of defensive barriers against the human common cause failures. The BIR study demonstrated a joint analysis of data on risk importance from PSA and on maintenance activities from the plant information system for equipment in component cooling water system. The approach for planning a risk-informed and cost-effective maintenance programme supports the utilities' planning, updating and analysis of the maintenance programme to be more effective and better justified from the plant safety, availability and cost management point of view.

The method developed to support risk-informed management of fire situations can be used in the development of the operators' training and procedures, the fire alarm system and the division of labor in the main control room. It supports the development of co-operation between the control room operators, the fire fighting organisation and other relevant parties and can be utilised in improving the realism of HRA for fire PSA.

The approach developed to the risk-informed categorisation complies with the Finnish regulatory PSA guide, which asks for an assessment of safety classification using PSA. In general, the risk-informed categorisation should be seen as an approach to support selection of appropriate and cost-effective methods to control risk.

The reliability estimation method for computer-based systems provides justified failure probabilities to be used in quantitative reliability analysis of safety functions implemented using programmable technology. Same time, the method provides guidance on the evidence needed for a good reliability estimate.

The Markov model based modelling tool developed can be used to a reliability analysis of simple systems with long term mission time. Recovery of failed components, logistic delay in repair and time dependent behaviour of the time system tolerates failed components can be taken into account.

Conclusions

The challenges of risk-informed decision making can be discussed in two levels: 1) decision making practices when using risk-information and 2) quality of risk-information. Formal decision analysis methods developed in the project is one prerequisite for successful applications. Another important factor is the promotion of interdisciplinary expert co-operation and communication. Jointly developed conceptual

models facilitate the integration of expertise from different domains and support the identification and definition of the risk-informed ways of acting in decision making. The quality of risk-information can be improved by collection of operating experience, by applying appropriate probability models and by focusing on informative and pedagogic presentation of results. The Bayesian framework could be utilised more e.g. in software reliability and human reliability assessment, as demonstrated in the project.

The PPRISMA project has also been active in international co-operation through e.g. OECD/NEA Working Groups Risk (WGRISK) and Operating Experience (WGOE), Nordic Nuclear Safety Research (NKS), Nordic PSA Group (NPSAG), IAEA Technical Working Group on nuclear power plant control and instrumentation, European Union Joint Research Centre (EU-JRC) in Petten and European Safety, Reliability and Data Association (ESReDA). Results have been presented internationally at the most important conferences in this field.

References

1. Simola, K. & Pulkkinen, U. Risk-informed decision making – a pre-study. Roskilde: Nordic Nuclear Safety Research, 2004, (NKS-93). 15 p. + app. 12 p.
2. Knochenhauer, M., Holmberg, J.-E., Hultqvist, G. & Ingemarson, I. The validity of safety goals, In: Proceedings of the 8th International Conference on Probabilistic Safety Assessment and Management May 14–18, 2006, New Orleans, Louisiana, USA. New York: ASME, 2006. Paper PSAM-0162. 7 p. ISBN 0-7918-0244-2.
3. Laakso, K. Systematic analysis and prevention of human originated common cause failures in relation to maintenance activities at Finnish nuclear power plants. Espoo: VTT Industrial Systems, 2005. 39 p. (To be published in in STUK series).
4. Laakso, K. & Luukkanen, P. Development of maintenance strategies for a nuclear power plant. In Congress report of 18th Euromaintenance 2006 and 3rd WorldCongress of Maintenance. June 2006. Basel. MM Support GmbH. CH-3000 MM Support GmbH. CH-3000 Bern. Pp. 495–502.
5. Rosqvist, T. & Laakso, K. The Burden to Importance Ratio – a demonstrative study on BIR application for resource allocation of condition based maintenance. Espoo: VTT Industrial Systems, 2004, (BTU062-031189). 19 p.
6. Laakso, K. Inhimillisperäisten yhteisvikojen esteiden jatkoanalyysi kohteena Loviisan voimalaitos. Espoo: VTT Industrial Systems, 2004, (BTU062-031211). 33 p. + app. 17 p. (In Finnish).

7. Hukki, K. & Holmberg, J.-E. Development of Management of Nuclear Power Plant Fire Situations. In: Spitzer, C., Schmocker, U., Dang, V. N. (eds.). Probabilistic Safety Assessment and Management 2004. Proceedings of the Probabilistic Safety Assessment and Management Conference PSAM 7 – ESREL '04, Berlin, Germany, June 14–18, 2004. Springer-Verlag London Ltd. Pp. 376–382.
8. Holmberg, J.-E. & Hukki, K. Interdisciplinary Expert Collaboration Method (IECM) for Supporting Human Reliability Analysis in Fire PSA. In Proc. of International Topical Meeting on Probabilistic Safety Analysis (PSA 05), September 11–15, 2005, San Francisco, California, American Nuclear Society, Inc., La Grange Park, Illinois, USA, 2005. ISBN 0-89448-690-X.
9. Hukki, K. & Holmberg, J.-E. Systeminen näkökulma ydinvoimalaitoksen palotilanteiden riskitietoiseen hallintaan. Vuoden 2005 työraportti. Espoo: VTT, 2006, (Report VTT-R-06-00074). 23 p. (In Finnish).
10. Männistö, I. Risk-informed classification of components of nuclear power plants. Espoo: Helsinki University of Technology, Department of engineering physics and mathematics, M.Sc. Thesis, 2005. 75 p.
11. Haapanen P., Helminen A. and Pulkkinen U. Quantitative reliability assessment in the safety case of computer-based automation systems. Helsinki: Radiation and nuclear safety authority, Radiation and nuclear safety authority, 2004, (STUK-YTO-TR 202). 36 p.
12. Helminen, A. & Pulkkinen, U. Quantitative reliability estimation of a computer-based motor protection relay using Bayesian networks. SAFECOMP 2003 – Computer Safety, Reliability and Security, Edinburgh, United Kingdom, Sept. 23–26, 2003. 11 p.
13. Helminen, A. Case study on reliability estimation of computer-based device for probabilistic safety assessment. Espoo: VTT Industrial Systems, 2005, (Report BTUO62-051375). 30 p. + app. 2 p.
14. Karanta, I. Utilizing operational data in Bayesian software reliability estimation. Espoo: VTT, 2006 (VTT Working Papers 63).
15. Björkman, K. Long Mission Time Reliability. Espoo: VTT, 2006, (Report VTT-R-10134-06). 32 p.

28.2 Interdisciplinary development of risk-informed management of fire situations

Kristiina Hukki & Jan-Erik Holmberg
VTT

Abstract

A method has been developed for supporting risk-informed management of fire situations at the plants. One purpose of the method is to enable the *integration of relevant expertise* from different domains related to the management. The method provides a shared frame of reference that facilitates crossing the disciplinary boundaries and, therefore, enhances mutual understanding. Another purpose is to gain more understanding of the *controllability* of fire situations by identifying the possible problems and difficulties of the management and to contribute to the development of adequate support for the management.

A *scenario analysis* method has been created for the design and analysis of different fire situations. It includes identification of critical assessment tasks and analysis of possibilities of the various actors (the control room operators, fire fighters and other relevant parties) to make the critical assessments in a fire situation. A *systemic network analysis* method has been developed for considering the controllability of fire situations from the co-operational point of view. The way the different parties interact has been regarded as an important factor influencing controllability and, therefore, the way safety is constructed in the management. The analyses have been developed in co-operation with Loviisa and Olkiluoto plants by utilizing interdisciplinary expert group work available at the plants.

Introduction

Significance of fires to nuclear power plant risk is demonstrated by numerous probabilistic safety assessments (PSA). Fire situations may be very demanding, due to the complexity and uncertainty inherent in these situations. The propagation of the fire and the effects of the fire on the plant process and on the systems and devices may be very hard to foresee. The circumstances may deteriorate the physical and mental capacity of those participating in the management.

The problems of the management of fire situations are reflected in the difficulties experienced in the development of procedures and training for fire situations [1]. According to the safety guide regarding fire safety, specialized fire safety training

should be sufficient to ensure that individuals understand the significance of their duties and the consequences of errors arising from misconceptions or lack of diligence [2]. It is not clear in which way a sufficient understanding can be gained in fire situations.

Risk-informed, performance-based regulation, introduced by the US Nuclear Regulatory Commission (NRC), emphasizes shared common objectives and common indicators of safety performance between the licensee and the regulator [e.g. 3]. Licensees are encouraged to use risk information in support of changes in the licensing basis so that all safety aspects of the proposed change are evaluated in an integrated manner as part of an overall risk management approach [4]. This way of acting requires a common conception of safety in the plant organization.

Achieving a shared understanding of the safety-critical demands of the management requires an integration of all the relevant expertise at the plant [5]. This means experience and knowledge of the experts responsible of the management of the fire situations (the operators, the fire fighters and other relevant parties), those contributing to the development of the procedures and training for the management, and those responsible for fire PSA at the plant (the safety engineers). The integration of the different views makes it easier to gain an overall understanding of the management and to take all the personal knowledge into account. The importance of integrating knowledge from different domains has also been emphasized by, e.g., Rasmussen in his considerations of industrial risk management [6].

It is not, however, easy to create a common concept, due to the differences in the disciplinary practices and ways of thinking in the organization and to the tendency to adhere to one's own field of expertise [7, 8, 9]. Therefore, the co-operation should be accomplished in a group work where a shared frame of reference is jointly developed and used in order to create a shared understanding. As the conceptions of risk and safety concerning NPP fire situations vary, a conceptual framework is needed that makes it possible to analyze the fire situations from the risk point of view in a way that facilitates crossing the disciplinary boundaries.

The IECM method for supporting management of fire situations

In PPRISMA project a method has been developed, the purpose of which is to support expert group work at the plants in enhancing risk-awareness concerning the management of fire situations [5, 10, 11]. The development of the method itself has been based on interdisciplinary expert group work at Loviisa and Olkiluoto plants. The members of the group represented the active parties concerned with the management of the fire situations: control room crew, operator training, fire organization (local and external) and safety analysis.

The method, called the Interdisciplinary Expert Collaboration Method (IECM), facilitates the integration of the experts' views, knowledge and experience by providing them a systematic practice and a shared conceptual tool for the analysis of the fire situations. The aim is, with the help of the method, to gain an understanding of the potential risks inherent in the fire situations and the actual possibilities of preventing and mitigating these risks in on-line decision making. The identification of the constraints and difficulties of decision making [cf. 6, 12] makes it possible to consider the fire situations from the *controllability* point of view and, as a consequence, makes it easier to develop adequate support for the management.

The main idea of the analysis of controllability of fire situations, introduced here, is close to the consideration of potential systemic degradation of deficiencies in safety-critical organizations [e.g. 6]. The roots of the analyses, provided by the method, lie, on one hand, on the core-task approach concerning the identification of the core content of work [e.g. 13, 14]. This approach is close to the formative work domain analysis of Vicente [12]. On the other hand, the basis is on the systemic approach concerning cooperation and knowledge integration in multidisciplinary and interdisciplinary expert work [7, 8, 15].

In the first phase of the development of the method a *scenario analysis* was created for expert group work. The main idea was to develop a generic plant-specific model which can be used as a reference in the design and analysis of different fire scenarios and in the assessment of task performances. The generic reference model describes, in the form of tables, the management of fire situations from the *control room chief supervisor's* point of view.

The chief supervisor's decision making is considered with regard to risk. "Risk" is understood here broadly, accounting not only the core damage risk, but also e.g. risk of injuries, economical damages, environmental damages and damage to the utility's *imago*. Due to the complexity and huge variety of fires, rule-based management prescribed, e.g., in instructions, can never be a sufficient method of management. Therefore, risk-informed actions are needed to complete the rule-based actions typically defined in instructions. The risk-informed way of acting means that uncertainties in the situation are taken into account and threats to plant safety are anticipated and prevented.

The reference model describes the chief supervisor's cognitive task demands which have been defined as the most critical assessments required by the situation. They have been derived from the most important control tasks concerning rescue, process control and fire fighting, defined in the plant procedures. In addition, the potential risks and difficulties related to each assessment task have been described. Examples of the risks

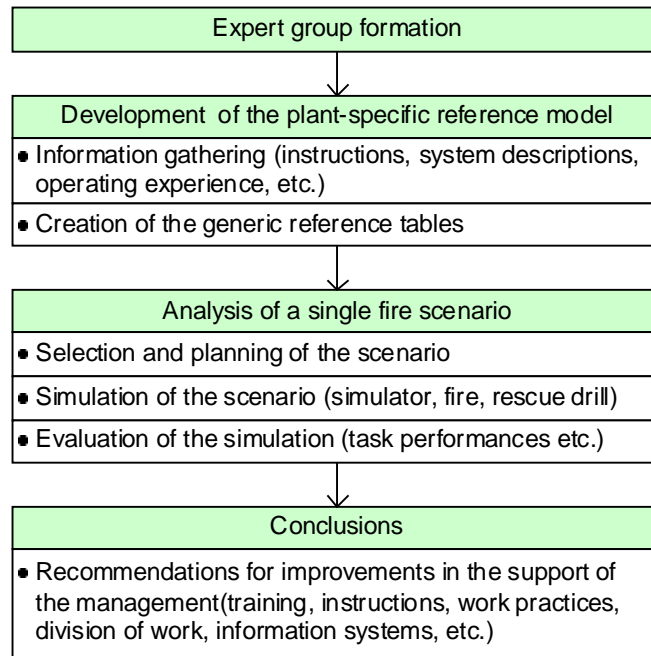

Figure 158. Steps in the development of the scenario analysis.

are, e.g. threats concerning injuries, economical damages, etc. Potential difficulties are issues like deficiencies of the procedures, unreliability of information, problems related to the technical systems and devices, etc. Figure 158 presents the steps in the development of the scenario analysis. The members of the expert group represented the relevant expertise concerning management of fire situations. After the generic plant-specific reference tables had been developed they were applied to different fire scenarios. The scenarios were selected on the basis of the results of fire PSA. They were applied in integrated simulator and fire and rescue drills at both plants. The results of the applications can be utilised in the improvement of work practices, procedures, training and the fire alarm system.

Further development of the IECM framework

Many tasks in fire situations require successful co-operation between the fire fighters, the operating personnel and other relevant parties. One finding of the research work, described above, was that the co-operational aspect of the management has not been taken sufficiently into account at the plants. The different parties responsible for the management do not share a common concept of the fundamental safety requirements concerning the management. Knowledge of the other parties' work and its boundary conditions is not sufficient. The procedures and training concerning the management are mostly separate for the different parties. In addition, the co-operation between the experts responsible for the support for the management has not been comprehensive and systematic enough.

In the further development of the method the scope of the analysis was extended to the consideration of the management as a co-operational whole, i.e., the controllability of the fire situations was analyzed from the *co-operational* point of view. The idea of the *systemic network analysis* method was to consider the role and significance of co-operation in the management of fire situations. This required identification of the *functional goals* of the management as a whole [cf. 6, 12].

As the starting point, the *safety functions* of the management of fire situations were defined. At the plants “safety functions” of the management of nuclear process are defined as safety-critical functions, the purpose of which is to prevent reactor accidents [16]. Here they have been defined in a more general way and connected with the concept of risk by considering them as technical or organizational functions to reduce particular risk sources [17]. Safety functions describe the goals of the management of fire situations. They concern issues like rescue operations, protection against a reactor core damage or against other radiological hazards, protection of property, etc.

A safety function is an abstract concept that becomes concretized through the automatic technical systems of the plant and through the human interventions. Here the focus is on the latter ones. They are operational tasks or task combinations, the purpose of which is to contribute to maintaining the safety functions. These tasks can be regulated by instructions in principle but not completely because all the possible situations cannot be accounted. They have interdependent connections and many of them require co-operation of the different parties. The co-operational tasks needed for accomplishing the safety functions are here called the *co-operational control tasks* of the management of fire situations. These tasks cross the boundaries of fire fighting and process control.

The co-operational control tasks were selected as the units of the analysis that was made for considering the co-operation of the different parties. Like in the development of the scenario analysis, described above, the actual possibilities of gaining an understanding of the critical issues concerning the fire situation were examined. In addition, the possibilities to carry out the needed operations in a right and well-timed way were considered an essential prerequisite of controllability. The focus of the analysis was on how the deficiencies and problems of communication and of the way work is organized between the different parties may deteriorate the controllability of the situation.

Four co-operational control tasks were identified and selected for the task-specific analysis: 1) Initiation of the safety functions required by the fire, 2) De-energization of the target room, 3) Prevention of the damages caused by smoke and 4) Prevention of the damages caused by water. The first ones (1 and 2) were regarded as more interesting objects of analysis and were, therefore, examined more thoroughly.

First, the task phases were defined for each control task. Secondly, the most important situation assessments required by the situation were identified and the operational activities to be carried out were defined for each phase. After that, the points of co-operation were identified, again for each task phase. These points were considered by identifying the informational, time-related and resource-related dependencies between the different parties' work tasks. Information needs, coordination of operational actions, assistance to operations, time windows etc. are examples of these dependencies. The last step of the analysis was the identification of the possible problems related to carrying out the control tasks. The problems were categorized in two groups: 1) difficulties in making assessments of the situation or 2) difficulties in accomplishing the required operational actions.

As an example, the co-operational network in control task 2 is presented in Figure 159. The existence of energized electrical systems in the target room is a problem to be solved by the network consisting of the plant operators, the fire organization, the electricians and the plant emergency organization. Here the important issues to be assessed are: Is de-energisation necessary? Is it possible to carry out the de-energization? Can the sufficiency of de-energization be ensured? What are the operational alternatives if it can not be ensured?

Potential difficulties with de-energization can be lack of procedures, lack of sufficient documentation of cables, complexity of steps to be taken, need for experts outside the plant. Risks are the health risks of the fire fighters, unwanted process consequences if or if not de-energized (e.g. loss of technical safety functions) and delayed or reduced opportunity to extinguish the fire. The co-operational network needs to be aware of the above difficulties and share the knowledge by communicating.

The results of the performed analyses indicate issues where information, time or resource related dependencies between the tasks may generate risks and endanger the controllability of the fire situation.

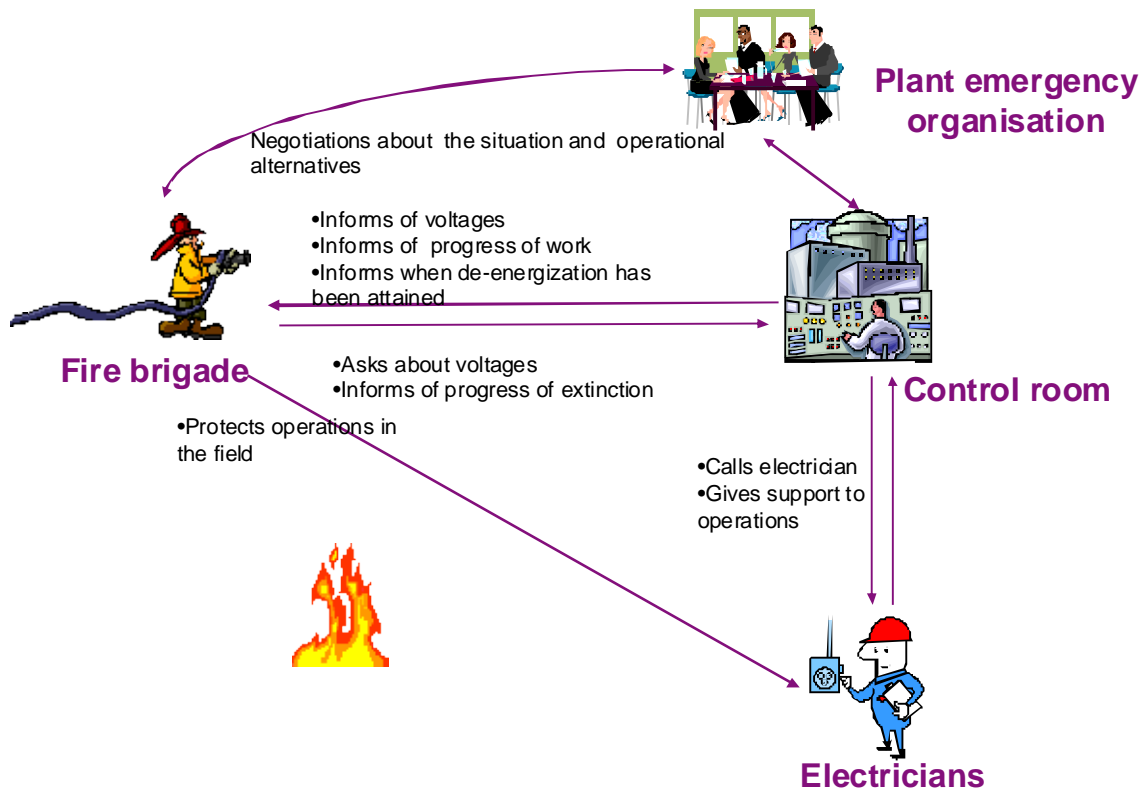

Figure 159. Co-operational network in the de-energization of energized electrical systems in the target room.

The following factors affect the possibility to make proper assessment of the situation:

- knowledge of the plant, e.g., of the cable routes
- possibility to get information during the situation
- sufficiency, timing and validity of the gained information
- functioning of the communication tools
- way of communicating in the co-operational network
- on-line risk assessment concerning injuries and plant safety.

The following factors affect the possibility to perform operations:

- available time
- availability and usability of the technical systems and devices
- sufficiency of the human resources
- availability of external help (e.g. electricians)
- availability of guidance for reaching the target room
- reachability of the target area and physical circumstances in the target area.

The analyzed control tasks are co-operationally demanding. The parties are used to view the situation from their own angles, due to the differences of domain-specific knowledge, practices and ways of thinking. Enhanced understanding of the interdependencies would facilitate the understanding of the co-operational whole and the safety-significance of co-operation and own ways of acting as a contribution to the whole [7, 8, 15]. It is important to understand the consequences of the ways of communicating and organizing the operations on the possibilities to accomplish the control tasks. Therefore, “risk-informed” management of fire situations should also include the understanding of the *safety-significance of the co-operational dependencies* [7, 8, 15].

Conclusions

The scenario analysis method provided by the IECM offers means for gaining more profound knowledge of the management of fire situations from the control room point of view. The systemic network analysis method takes the co-operational nature of the management of fire situations into account and makes it possible to identify the potential weak points in the co-operational system which may endanger plant safety.

The method has facilitated the integration of different expertise at the plants. The expert group work seems to have worked well also in that the discussions have made the different parties’ work more familiar to the others. Moreover, the common seminar that was arranged for both plants after the group work period was experienced useful and interesting.

By far, in the development of the network analysis the most important co-operational control tasks in the management have been identified and preliminary analyses have been made of the co-operational issues. The next step is to continue and deepen the analysis of the interdependencies between the different parties in order to be able to specify the possible factors that may impair the controllability of fire situations.

The long term goal is to provide knowledge that can be used to support the development of a plant-specific safety concept concerning fire situations at the plants. The concept is the shared understanding of the way fire safety is constructed in the co-operational system. It presents the requirements concerning operating and co-operating in a fire situation. Consideration of the actual possibilities of fulfilling the requirements makes the development needs of co-operation visible and lays basis for the development of integrated support for parties in the fire management. The fire safety concept would also support the co-operation between the plants and facilitate the interaction between the plants and the regulator. Moreover, it would contribute to the fire risk analysis by improving the realism of the human reliability analysis (HRA) [10].

References

1. Hukki, K. Management of nuclear power plant fire situations. Points of view related to problems of decision-making and co-operation. Research Report based on interviews, TAU A010, VTT Automation, 2002. (In Finnish).
2. IAEA Fire Safety in the Operation of Nuclear Power Plants. Safety Guide. IAEA Safety Standards Series No. NS-G-2.1. Vienna, 2000.
3. US NRC. Risk-informed, performance-based regulation, White Paper, March 1999.
4. US NRC, An Approach for Using Probabilistic Risk Management in Risk-Informed Decisions On Plant-Specific Changes to the Licensing Basis, Regulatory Guide 1.174. U.S. Nuclear Regulatory Commission, 1998.
5. Hukki, K. & Holmberg, J. Development of Management of Nuclear Power Plant Fire Situations. In: C. Spitzer, U. Schmocker, V. N. Dang (eds.). Probabilistic Safety Assessment and Management 2004. Proceedings of the Probabilistic Safety Assessment and Management Conference PSAM 7 – ESREL '04, Berlin, Germany, June 14–18, 2004a. Springer-Verlag London Ltd. 7 p.
6. Rasmussen, J. Risk management in a dynamic society: A modelling problem. *Safety Science*, 1997, Vol. 27, No. 2/3, pp. 183–213.
7. Hukki, K. & Pulkkinen, U. Cognitive prerequisites for safety-informed organizational culture. Proceedings of the European Safety and Reliability Conference ESREL 2003, Maastricht, June 15–18, 2003.
8. Hukki, K. & Pulkkinen, U. Enhancing Transparency in Multidisciplinary Expert Communication. Proceedings of the 3rd Symposium on Values in Decisions on Risk VALDOR 2003, Stockholm, June 9–13, 2003.
9. Launis, K. Multidisciplinarity and Crossing the Boundaries in Expert Work. In: Kirjonen, J., Remes, P. & Eteläpelto, A. (eds.). *Changing expertise*, University of Jyväskylä, Jyväskylä, 1997. (In Finnish).
10. Holmberg, J. & Hukki, K. Interdisciplinary Expert Collaboration Method (IECM) for Supporting Human Reliability Analysis in Fire PSA. In: Proc. of International Topical Meeting on Probabilistic Safety Analysis (PSA 05), September 11–15, 2005, San Fransisco, California, American Nuclear Society, Inc., La Grange Park, Illinois, USA, 2005. ISBN 0-89448-690-X.

11. Hukki, K. & Holmberg, J. Systemic approach to risk-informed management of nuclear power plant situations. Research report VTT-R-06-00074, 2006. (In Finnish).
12. Vicente, K. Cognitive Work Analysis. Toward Safe, Productive, and Healthy Computer-Based Work. Lawrence Erlbaum, London, 1999.
13. Hukki, K. & Norros, L. Subject-centred and systemic conceptualisation as a tool of simulator training, *Le Travail Humain*, Vol. 61, No. 4. 1998, pp. 313–331.
14. Norros, L. Acting under uncertainty. The core-task analysis in ecological study of work. VTT Publications 546, VTT Industrial Systems, Espoo 2004. 241 p. ISBN 951-38-6410-3; 951-38-6411-1.
<http://virtual.vtt.fi/inf/pdf/publications/2004/P546.pdf>.
15. Hukki, K. & Pulkkinen, U. Systems Intelligence in Expert Interaction. In: Hämäläinen, R. P. & Saarinen, E. (eds.). *Systems Intelligence. Discovering a hidden competence in human action and organizational life*. Helsinki University of Technology, Systems Analysis Laboratory Research Reports A88, October 2004.
16. Corcoran, W. R., Porter, N. J., Church, J. F. & Cross, M. T. *The Critical Safety Functions and Plant Operation*. Nuclear Technology, 1981, Vol. 55.
17. Harms-Ringdahl, L. *Beskrivningar och modeller av säkerhetsfunktioner – en förstudie*. SKI Rapport 99:35, Statens kärnkraftinspektion, Stockholm 1999. (In Swedish).

29. Assessment of smart device software (ASDES)

29.1 Assessment of smart device software

Urho Pulkkinen, VTT
Robin E. Bloomfield, Adelard LLP

Abstract

The assurance of smart devices for use in critical applications requires the safety assessment of their software. The overall objective of this project is to develop an approach to the assessment of such smart device software that takes into consideration: 1) the particular issues of assessing COTS (commercial off-the-shelf) and the design and accessibility of smart devices, 2) regulatory context of the nuclear industry in Finland (e.g. YVL guides 2.0, 2.1, 2.7, 2.8, 5.5), 3) current practices of software assurance developed in Finland [1–6] and more widely in the UK and European projects [7–10].

The first phase of the project was to appraise existing Finnish and other research and practices to define a framework for assessment. As the second phase, the proposed approach applied to an actual smart device.

Introduction

Sensors for nuclear applications have been relatively simple analogue devices that have known performance properties and known failure characteristics. However, the sensor industry is increasingly using microprocessor-based “smart sensors”. Smart sensors can achieve greater accuracy, better noise filtering and in-built linearisation, and provide better on-line calibration and diagnostics features. So, given the difficulty in obtaining replacement analogue sensors, and the potential benefits of smart sensors, it is important that the nuclear industry develops a suitable approach for justifying the use of smart sensors in systems important to safety (SIS).

This issue is applicable to smart devices in general. Smart devices are a specific form of COTS (commercial off-the-shelf) product. COTS products are normally sold as a “black box” where there is no knowledge of the internal structure. However, their safety justification might require knowledge of their internal structure and development process. The justification of devices is an increasing problem because the software constitutes a valuable intellectual investment by manufacturers, and the civil nuclear companies purchase sensors in small quantities.

The approach needs to take into consideration the particular issues of assessing such type of COTS software and the generic research and practices already in place in the nuclear and other industries, specifically

- current practices of software assurance and associated research developed in Finland and more widely in the UK and European projects
- regulatory context of the nuclear industry in Finland and the approach to software reliability and particular concerns related to the black-box assessment of smart devices.

In the ASDES project, the Safety Case approach was proposed for assessment of smart devices. A generic Safety Case compatible with Finnish regulatory context was outlined. The approach was then applied to an actual smart device, in cases of selected safety related functions at Finnish nuclear power plants.

Safety Case approach

According to Bloomfield and Bishop [11] safety case is *a documented body of evidence that provides a convincing and valid argument that a system is adequately safe for a given application in a given environment*. It is based on the analysis of the requirements set on the system under consideration. The requirements (which may be functional, safety or reliability requirements, or requirements concerning the systems development process) are used to form *claims* about the systems properties. The validity of claims is demonstrated by *evidence* and *inference* (see Figure 160).

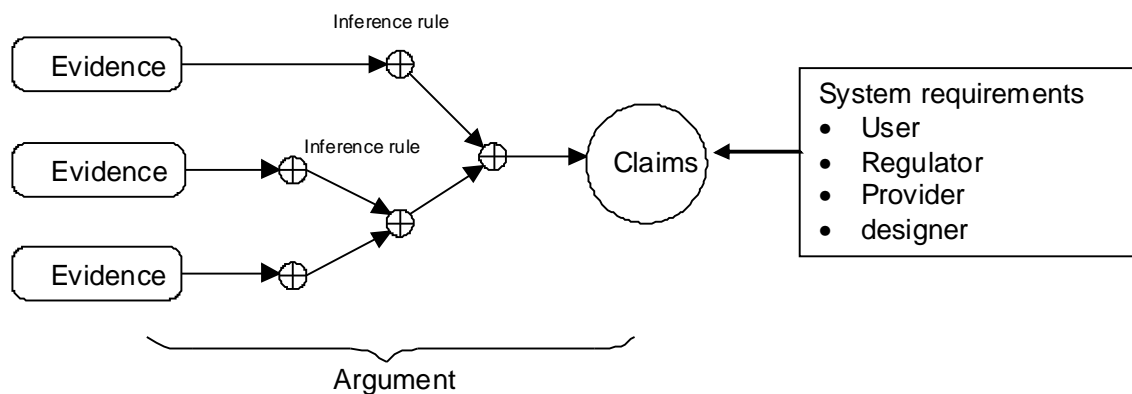

Figure 160. General structure of a safety case.

The elements of a safety case are explained in Table 27.

Table 27. The elements of a safety case.

Element of a safety case	
Claim	A statement about a property of the system or subsystem.
Evidence	A basis of safety argument; facts e.g. based on scientific principles and research), assumptions, subclaims derived from lower level sub-arguments.
Argument	Link between evidence and claim, can be deterministic, probabilistic or qualitative.
Inference	The mechanism that provides the transformational rules for the argument.

To implement a safety case, 1) an explicit set of claims about the system, 2) supporting evidence, 3) set of safety arguments that link the claims to evidence, 4) clear assumptions and judgements underlying the arguments, and, 5) different viewpoints and levels of detail are needed.

The claims may cover e.g. reliability and availability (qualitative, quantitative), usability, functional correctness, time response, accuracy, maintainability, fail-safety, robustness to overload, modifiability, structural integrity of the system.

The argumentation may be deterministic, probabilistic or qualitative. Deterministic argumentation is application of predetermined rules to derive a true/false claim; e.g. a formal proof of compliance to a specification or demonstration of dependability requirement. Probabilistic argumentation is statistical reasoning, applied to establish a numerical level of a property of the system (e.g. failure probability, MTTF, MTTR). Qualitative argumentation is the demonstration of compliance with rules that have an indirect link to the desired attributes (e.g. compliance with standards, staff skills and experience). Examples of argumentation are given in Table 28.

Table 28. Examples of argumentation.

<i>Attribute</i>	<i>Design etc. features</i>	<i>Evidence, assumptions</i>	<i>Subsystem requirements</i>	<i>Claim</i>
Fail-safety	Use of functional diversity	System hazard analysis	Fail safety requirements for subsystems;	Claim that dependability is maintained under stated conditions.
	Fail-safe architectures	Fault tree analysis	response to failure conditions	
Reliability, availability	Redundant architecture, segregation	Reliability of components, CCF assumptions	Hardware component reliability	Reliability claim based on modelling and CCF assumptions, together with fault detection and repair assumptions
	Fault tolerant architectures	Failure rate, diagnostic coverage, test and maintenance intervals, repair time	Software integrity level	
	Design simplicity	Operating experience.	Component segregation requirements Fault detection and diagnostic requirements Maintenance requirements	
Response time	Design ensures overall response time is bounded	Assumes subsystem time budgets can be met	Time budgets for hardware interfaces and software	Claim that overall system design can meet time response
Functional correctness	System partitioned according to criticality Design simplicity	Assumption that segregated functions can't affect each other	Subsystem integrity level Functional segregation requirements	Claim that response behaviour of the critical functions implements the overall function

Smart device safety case

The smart device selected for demonstrating the safety case approach was the Moore Industries SPA² Site Programmable Alarm unit. SPA² unit provides a monitoring function for signals from temperature sensors and other sensors and monitoring equipment. The front panel continuously displays the process variable, scaled to chosen units. Alarm outputs are available which trigger on high or low limit values and on the rate of change of the input, and the parameters are fully programmable on the front panel of the unit itself. A linearised and smoothed analogue output is optionally provided. The device is described in more detail in references [12–13].

The application cases were obtained from the Finnish nuclear power plants. In the Olkiluoto NPP case, a group of twelve temperature transmitters from different systems communicating with the plant's temperature supervision system (TSS) were considered. This case corresponds to a situation, where same device should be applicable to several places at the plant. A super-set of requirements compiled from the measurement point specific requirements need to be generated.

Basically, the temperature measurement points of this group can be categorized into two groups from their functional role point of view:

- Measurements with process control functions. If the temperature is too high in the pipe line under supervision, the device sends a stopping signal to a pump or closing signal to a valve, thus protecting the pump, heat exchanger or other part in the pipe line not to be damaged. High temperature is an indication of lacking cooling. (321K506, K507, K509, K510, 763K510, 511)
- Measurements providing information to the operators. In this case, the measurements are related to the condition in the reactor containment and can provide useful information in an accident situation. The measurements are not, however, part of the so called "essential accident instrumentation" which have stringent quality requirements. (316K517, K518, 547K501, K502, 741K513, K514)

Generally, the utility applies safety class 3 and the environmental class IE requirements for all the components. From the reliability requirements point of view, the measurements with process control functions are included in the plant-specific PSA (probabilistic safety assessment). The failure mode "spurious stop signal from the transmitter" is accounted as a cause for a system or pump stop. The importance of the transmitters to the core damage risk point is negligible. On the other hand, a transmitter failure may force to shut down the plant, so the transmitters can get reliability requirements also from the plant availability point of view.

In the case selected from the Loviisa NPP, the temperature transmitters belong to a system responsible for cooling a room where certain pumps important to safety are located. The safety systems in question are the low pressure emergency cooling system (TH system), emergency make-up system (TJ system) and the containment sprinkler system (TQ system). The TH, TJ and TQ pumps are normally in standby and are actuated by the plant protection signal (so called YZ-signal in Loviisa NPP). Cooling of the room is needed when the pumps are in operation since the pumps provide 65 kW thermal power (per room) and the room temperature would exceed the design limit +40°C without air cooling. The safety class of the room cooling system including temperature measurement is 3.

From the reliability requirements point of view, the transmitters are included in the plant-specific PSA (probabilistic safety assessment). A single failure “no actuation when needed” of the transmitter is not yet critical to the safety functions performed by the systems TQ, TH and TJ, but a common cause failure (CCF) can be critical.

Both of the NPP cases are describe in more detail the working report [14]. We emphasise here that the Olkiluoto and Loviisa case studies should be seen as reference cases, not as real safety case analyses.

Based on the analysis of the requirements of YVL-Guides (e.g. YVL guides 2.0, 2.1, 2.7, 2.8, 5.5) and the case dependent requirements the following top-level goals were identified:

- Goal 1: the description of the tin is adequate
- Goal 2: the component behaves according to the description when commissioned
- Goal 3: the component will continue to behave according to the description over its lifetime
- Goal 4: the integrity of supply is adequate, so increase confidence that the process is adequate and on evidence supplied.

The above goals were decomposed into behavioural, architectural, process and evidence directed sub-goals. The behavioural sub-goals are related to specific observable behaviours (e.g. accuracy, time response, reliability). The architectural sub-goals are based on the structure of the device: for example, the accuracy depends on the accuracy of the A-D converted, the transmission function and the D-A converter. Sub-goals about the supplier’s process can be expanded analogously: they may, for example, be supported by direct evidence at the supplier interface, observed consistency of behaviour of the same product type, consistency with customer orders, and general supplier reputation. Evidence based decomposition leads to sub-goals which might

depend on the available evidence or the cost of providing new evidence. The evidence required is likely to vary with the SIL (= Safety Integrity Level), in the case of ASDES project only the evidence needed for SIL 2 was considered.

During the process of developing the goals and sub-goals, the relevance of the YVL Guide clauses was assessed. Based on the assessment, a spreadsheet providing a commentary on each clause was produced. The spreadsheet can be used to assess the completeness of safety case and by integrating into the case, it is possible to provide a “compliance case” with respect to YVL Guidelines.

Discussion and conclusions

In the project, an “ASDES style” approach to the justification of smart devices was developed. The approach is goal based method that defines claims, elaborates and apportions them to smart devices and components and then creatively identifies the arguments required to show these claims. Then, one has to assess whether the claims are satisfied in the light of available evidence.

Guidelines and standards provide a reference to possible activities and techniques that can be used to generate the required evidence. It is proposed that one viewpoint to from the goal based approach is one that demonstrates and justifies the extend of standards compliance but that compliance in itself is not sufficient for software based systems.

The smart device specific aspects of the approach are in detail of the claim structure and arguments that are applicable but also structuring of the approach into what the sensor does “on the tin” and the application specific aspect.

The goal based view emphasises the claim and argument structure. This is important as in our experience it is these aspects that are not well articulated. However it is equally important to be clear about what it is that is being justified. We therefore propose a more explicit model based approach that couples the goal-based viewpoint with a model based one.

The explicit use of models leads to an approach to “stopping rules” and the vexed question of whether access to software code is required. In the example discussed here the challenges to the design model assumptions drives us towards examination of the code. This is because typical industrial design notations of text and block diagrams are only suggestive of the device behaviour and do not provide either an executable model or one we can reason about.

We have sketched the approach for arguing about a response time of a device and also investigated coupling the argument for a device specifically to an application. In both of these we were seeking to support a deterministic argument that there were no credible failures whose size was significant. For the trip example we proposed an approach that combines testing with analytical results to bound the possible errors.

References

1. Helminen, A. & Pulkkinen, U. Programmable automation system safety assessment (PASSI). In: Kyrki-Rajamäki, R. & Puska, E. K. (eds.). FINNUS The Finnish Research Programme on Nuclear Power Plant Safety 1999–2002. Final Report. VTT Research Notes 2164, Espoo, Finland, 2002, pp. 211–217.
<http://virtual.vtt.fi/inf/pdf/tiedotteet/2002/T2164.pdf>.
2. Haapanen, P., Helminen, A. & Pulkkinen, U. Quantitative reliability assessment in the safety case of computer-based automation systems. Report STUK-YTO-TR 202, Radiation and nuclear safety authority, Helsinki, 2004.
3. Kopustinskas, C., Kirchsteiger, B., Soubies, F., Daumas, J., Gassino, J. C., Peron, P., Regnier, J., Maertz, M., Baleanu, H., Miedl, M., Kersken, U., Pulkkinen, M., Koskela, P., Haapanen, M. L., Järvinen, H. W. Bock & W. Dreves. Benchmark exercise on safety evaluation of computer-based systems (BE-SECBS). In: Proc of FISA-2003. EU Research in Reactor Safety. 10–13 November 2003, Luxembourg.
4. Nevalainen, R. & Harju, H. Qualification of Safety-related Systems for Nuclear Power Plants in Finland. In: Proc. of 4th International SPICE Conference on Process Assessment and Improvement, Lisbon, Portugal, 28–29 April 2004.
5. Norrman, S. & Holmberg, J. Automation & Reactor Safety: Requirements, Assessment & Concepts (ARRAC). In: Proc. of the Nordic Seminar on Nuclear Automation Oskarshamn, Sweden 5–7 April 2004.
6. Sivertsen, T., Fredriksen, R., Thunem, A. P.-J., Holmberg, J.-E., Valkonen, J. & Ventä, O. Traceability and Communication of Requirements in Digital I&C Systems Development. Project Report 2003. Report NKS-91, Nordic Nuclear Safety Research, Roskilde, 2004.
7. Bishop, P. G., Bloomfield, R. E., Guerra, A. S. L. & Turlas, K. Justification of smart sensors for nuclear applications. In: Proceedings of the 5th International Conference on Control and Instrumentation in Nuclear Installations, 21–23 September 2004.

8. Bishop, P. G., Bloomfield, R. E. & Froome, P. K. D. Justifying the use of software of uncertain pedigree (SOUP) in safety-related applications. Health and Safety Executive Contract Research Report, CRR 336/2001. ISBN 0-7176-2010-7, HSE, May 2001.
9. Jones, C., Bloomfield, R. E., Froome, P. K. D. & Bishop, P. G. Methods for assessing the safety integrity of safety-related software of uncertain pedigree (SOUP). Health and Safety Executive Contract Research Report CRR 337/2001. ISBN 0-7176-2011-5, HSE, May 2001.
10. Cost Effective Modernisation of Systems Important to Safety. <http://www.cemsis.org>.
11. Bishop, P. G. Bloomfield, R. E. A methodology for safety case development. Safety-Critical Systems Symposium (SSS'98), Birmingham, UK, Feb 1998.
12. SPA² TPRG Installation Manual, Moore Industries, June 2004. Available: [fromhttp://www.miinet.com/custservice/install_manuals.shtml](http://www.miinet.com/custservice/install_manuals.shtml).
13. SPA² Data Sheet, Moore Industries, June 2004. Available: http://www.miinet.com/custservice/products/sg_alarm.shtml.
14. Holmberg, J.-E. & Pulkkinen, U. Bloomfield, Robin, Guerra, Sofia, VTT Energia, Daniel. Description of the ASDES case studies. VTT Research Report VTT-R-00923-06.

Appendix A: Publications of the projects

Enhanced methods for reactor analysis (EMERALD):

Scientific publications

Daavittila, A., Hämäläinen, A. & Kyrki-Rajamäki, R. Effects of secondary circuit modeling on results of PWR MSLB benchmark calculations with new coupled code TRAB-3D/SMABRE. *Nuclear Technology*, Vol. 142, No. 2, May 2003. pp. 116–123. ISSN 0029-5450.

Hämäläinen, A. Applying thermal hydraulics modeling in coupled processes of nuclear power plants. VTT Publications 578, Espoo 2005. Doctor's thesis (Lappeenranta University of Technology, Department of Energy and Environmental Technology). 103 p. + app. 99 p. ISBN 951-38-6667-X; 951-38-6668-8. <http://virtual.vtt.fi/inf/pdf/publications/2005/P578.pdf>.

Kotiluoto, P. Verification of MultiTrans calculations by the VENUS-3 benchmark experiment. *Journal of ASTM International*, Vol. 3, Issue 3, March 2006. 6 p. Online ISSN 1546-962X.

Langenbuch, S., Krzykacz-Hausmann, B., Schmidt, K. D., Hegyi, G., Keresztúri, A., Kliem, S., Hadek, J., Danilin, S., Nikonov, S., Kuchin, A., Khalimanchuk, V. & Hämäläinen, A. Comprehensive uncertainty and sensitivity analysis for coupled code calculation of VVER plant transients. *Nuclear Engineering and Design*, 2005, Vol. 235:2–4, pp. 521–540. ISSN 0029-5493.

Mittag, S., Grundmann, U., Weiss, F.-P., Petkov, P. T., Kaloinen, E., Keresztúri, A., Panka, I., Kuchin, A., Ionov, V. & Powney, D. Neutron-kinetic code validation against measurements in the Moscow V-1000 zero-power facility. *Nuclear Engineering and Design*, 2005. Vol. 235:2–4, pp. 485–506. ISSN 0029-5493.

Syrjälähti, E. & Hämäläinen, A. HEXTRAN-SMABRE calculation of the VVER-1000 coolant transient-1 benchmark. *Progress in Nuclear Energy* 48 (2006), pp. 849–864.

Vanttola, T., Hämäläinen, A., Kliem, S., Kozmenkov, Y., Weiss, F.-P., Keresztúri, A., Hadek, J., Strmensky, C., Stefanova, S., Kuchin, A. et al. Validation of coupled codes using VVER plant measurements. *Nuclear Engineering and Design*, 2005. Vol. 235:2–4, pp. 507–519. ISSN 0029-5493.

Conference papers

Anttila, M. & Ranta-aho, A. Burnup calculations for a 10x10 BWR assembly – comparison of CASMO-4, MonteBurns 1.0 and MCB results. Studsvik Scandpower Users Group Meeting. April 19–21, 2004, Turku, Finland, 21 p.

Chen, Y., Wasastjerna, F., Fischer, U. & Simakov, S. Three-dimensional shielding calculations for the IFMIF neutron source using a coupled Monte Carlo/Deterministic computational scheme. 10th International Conference on Radiation Shielding (ICRS-10) / 13th Topical Meeting on Radiation Protection and Shielding (RPS-2004). May 9–14, 2004, Funchal, Madeira. *Radiation Protection Dosimetry* 2005 115(1–4):573–579. ISSN 1742-3406 (Online); ISSN 0144-8420 (Print).

Daavittila, A. TRAB-3D/TRAB pressure transient calculation. NKS-R 3D BWR Transient Methodology Seminar. April 8, 2003, Espoo, Finland. In: Daavittila, A. (ed.). 3D analysis methods – study and seminar. Roskilde: NKS Secretariat, 2003. Pp. 60–71. (Electronic report. http://130.226.56.167/nordisk/publikationer/1994_2004/NKS-89.pdf). ISBN 87-7893-147-9.

Daavittila, A., Hämäläinen, A., Miettinen, J. & Rätty, H. Transient and fuel performance analysis with VTT's coupled code system. International Topical Meeting on Mathematics and Computation, Supercomputing, Reactor Physics and Nuclear and Biological Applications. September 12–15, 2005, Avignon, France. [CD-ROM]. La Grange Park: American Nuclear Society, 2005. Paper 091. 12 p.

Hämäläinen, A. 3D methodology in VVER transients with uncertainty analyses. NKS-R 3D BWR Transient Methodology Seminar. April 8, 2003, Espoo, Finland.

Hämäläinen, A. & Kyrki-Rajamäki, R. HEXTRAN-SMABRE calculation of the 6th AER benchmark, main steam line break in a VVER440 NPP. In: Proceedings of the 13th Symposium of the AER on VVER Reactor Physics and Safety. September 22–26, 2003, Dresden, Germany. Budapest: Atomic Energy Research (AER), 2003. pp. 445–458. ISBN 963-372-630-1.

Hämäläinen, A., Vanttola, T., Weiss, F.-P., Mittag, S., Kliem, S., Kozmenkov, Y., Langenbuch, S., Keresztúri, A., Hádek, J., Strmensky, C., Stefanova, S., Kuchin, A., Hlbocky, P., Siko, D. & Danilin, S. Validation of coupled codes in VALCO WP1 using measured VVER data. In: Proceedings of the 13th Symposium of the AER on VVER Reactor Physics and Safety. September 22–26, 2003, Dresden, Germany. Budapest: Atomic Energy Research (AER), 2003. Pp. 555–576. ISBN 963-372-630-1.

Höglund, R. Reactor physics and dynamics research within the EMERALD project. XII Meeting on Reactor Physics Calculations in the Nordic Countries. May 19–20, 2005, Halden, Norway. 6 p. Also as EMERALD summary report in: Rätty, H. & Puska, E. K. (eds.). SAFIR, The Finnish Research Programme on Nuclear Power Plant Safety 2003–2006, Interim Report, VTT Research Notes 2272. VTT Processes. Espoo (2004). Pp. 22–29. ISBN 951-38-6515-0; ISSN 1235-0605.
<http://virtual.vtt.fi/inf/pdf/tiedotteet/2004/T2272.pdf>.

Höglund, R., Solala, M., Dahlbacka, K. & Latokartano, S. Shutdown margin in the case of a misplaced bundle in a BWR core. Studsvik Scandpower Users Group Meeting. April 19–21, 2004, Turku, Finland. 10 p.

Kotiluoto, P. Development of the new deterministic 3-D radiation transport code MultiTrans. Proceedings of the 11th Meeting on Reactor Physics Calculations in the Nordic Countries. April 9–10, 2003, Espoo, Finland & m/s Romantika. VTT Symposium 230, Espoo, 2003. Pp. 49–55. ISBN 951-38-6286-0.
<http://virtual.vtt.fi/inf/pdf/symposiums/2003/S230.pdf>.

Kotiluoto, P. The new deterministic 3-D radiation transport code MultiTrans: C5G7 MOX fuel assembly benchmark. In: Proceedings of the International Conference on Supercomputing in Nuclear Applications SNA'2003. September 22–24, 2003, Paris, France. La Grange Park: American Nuclear Society, 2003. Paper 118. 7 p.

Kotiluoto, P. Adaptive tree multigrids in 3D radiation transport: a review of development and testing of the new MultiTrans code. In: Proceedings of the 14th Symposium of AER on VVER Reactor Physics and Reactor Safety. September 13–17, 2004, Espoo, Finland & m/s Silja Symphony. Budapest: Atomic Energy Research (AER), 2004. Pp. 177–184. ISBN 963-372-631-X.

Kotiluoto, P. & Wasastjerna, F. VENUS-2 MOX-fuelled reactor dosimetry benchmark calculations at VTT. In: Proceedings of the International Topical Meeting on Mathematics and Computation, Supercomputing, Reactor Physics and Nuclear and Biological Applications. September 12–15, 2005, Avignon, France. [CD-ROM] La Grange Park: American Nuclear Society, 2005, Paper 043. 12 p.

Leppänen, J. Cross section library based discrepancies in MCNP criticality calculations. In: Proceedings of the International Conference Nuclear Energy for New Europe 2003. September 8–11, 2003, Portorož, Slovenia. [CD-ROM]. Ljubljana: Nuclear Society of Slovenia. Paper 101. 8 p.

Leppänen, J. A systematic study of cross section library based discrepancies in LWR criticality calculations. In: Proceedings of the 14th Symposium of AER on VVER Reactor Physics and Reactor Safety. September 13–17, 2004, Espoo, Finland & m/s Silja Symphony. Budapest: Atomic Energy Research (AER), 2004. Pp. 149–157. ISBN 963-372-631-X.

Leppänen, J. A systematic study of cross section library based discrepancies in LWR criticality calculations. In: Rätty, H. & Puska, E. K. (eds.). SAFIR, The Finnish Research Programme on Nuclear Power Plant Safety 2003–2006, Interim Report, VTT Research Notes 2272. VTT Processes. Espoo (2004). Pp. 30–37. ISBN 951-38-6515-0; ISSN 1235-0605. <http://virtual.vtt.fi/inf/pdf/tiedotteet/2004/T2272.pdf>.

Leppänen, J. Diffusion code group constant generation using the Monte Carlo method. XII Meeting on Reactor Physics Calculations in the Nordic Countries. May 19–20, 2005, Halden, Norway. 13 p.

Leppänen, J. A new assembly-level Monte Carlo neutron transport code for reactor physics calculations. In: Proceedings of the International Topical Meeting on Mathematics and Computation, Supercomputing, Reactor Physics and Nuclear and Biological Applications. September 12–15, 2005, Avignon, France. Paper 192. 12 p.

Leppänen, J. Current status of the PSG Monte Carlo neutron transport code. In: PHYSOR-2006: Advances in nuclear analysis and simulation. September 10–14, 2006, Vancouver, British Columbia, Canada. [CD-ROM] La Grange Park: American Nuclear Society, 2006. Paper B095. 10 p. ISBN 0-89448-697-7.

Mattila, R. ARES – a new BWR simulator. In: Proceedings of the 11th Meeting on Reactor Physics Calculations in the Nordic Countries. April 9–10, 2003, Espoo, Finland & m/s Romantika. VTT Symposium 230, Espoo, 2003. Pp. 57–60. ISBN 951-38-6286-0. <http://virtual.vtt.fi/inf/pdf/symposiums/2003/S230.pdf>.

Mattila, R. Three-dimensional analytic function expansion nodal model, In: ANS Topical Meeting on Advances in Nuclear Fuel Management III. October 5–8, 2003, Hilton Head Island, South Carolina, USA. [CD-ROM]. LaGrange Park: American Nuclear Society, 2003, Paper 06–05. 9 p. ISBN 0-89448-670-5.

Miettinen, J. & Rätty, H. The coupled code TRAB-3D-SMABRE for 3D transient and accident analyses. In: Rätty, H. & Puska, E. K. (eds.). SAFIR, The Finnish Research Programme on Nuclear Power Plant Safety 2003–2006, Interim Report, VTT Research Notes 2272. VTT Processes. Espoo (2004). Pp. 38–45. ISBN 951-38-6515-0; ISSN 1235-0605. <http://virtual.vtt.fi/inf/pdf/tiedotteet/2004/T2272.pdf>.

Miettinen, J., Vanttola, T., Daavittila, A. & Rätty, H. The combined thermohydraulics-neutronics code TRAB-SMABRE for 3D plant transient and accident analyses. In: ICONE-12: 12th International Conference on Nuclear Engineering. Washington D.C., USA, April 25–29, 2004 [CD-ROM]. New York: American Society of Mechanical Engineers, 2004. Paper ICONE-12-49452. 7 p. ISBN 0-7918-3734-3.

Ranta-aho, A. Testing of CASMO-4 and Monteburns 1.0 against Takahama-3 and Fukushima-Daini-2 post-irradiation experiments. In: Proceedings of the 14th Symposium of AER on VVER Reactor Physics and Reactor Safety. September 13–17, 2004, Espoo, Finland & m/s Silja Symphony. Budapest: Atomic Energy Research (AER), 2004. Pp. 661–673. ISBN 963-372-631-X.

Ranta-aho, A. Isotopic composition and criticality safety calculation system at VTT. 10th Meeting of the AER Working Group E entitled Physical Problems on Spent Fuel, Radwaste and Decommissioning of Nuclear Power Plants. April 18–20, 2005, Villa Szondra by Modra, Slovakia. 14 p.

Ranta-aho, A. Use of SSP code systems in Finland. Studsvik Scandpower International Users Group Meeting. June 1–3, 2005, Charlotte, North Carolina, USA. 22 p.

Ranta-aho, A. Validation of CASMO-4E against radiochemical assay data from Novovoronezh 4. 11th Meeting of the AER Working Group E “Physical Problems of Spent Fuel, Radwaste, and Decommissioning of Nuclear Power Plants”. April 11–12, 2006, Hrotovice, Czech Republic, 10 p.

Ranta-aho, A. Validation of depletion codes against VVER-440 spent fuel data. OECD/NEA/NSC WPNCs Workshop on the need for post irradiation experiments to validate fuel depletion calculation methodologies. May 11–12, 2006, Rez near Prague, Czech Republic.

Ranta-aho, A. Validation of depletion codes for burnup credit evaluation of LWR assemblies. In: PHYSOR-2006: Advances in nuclear analysis and simulation. September 10–14, 2006, Vancouver, British Columbia, Canada. [CD-ROM] La Grange Park: American Nuclear Society, 2006. Paper C172, 11 p. ISBN 0-89448-697-7.

Roque, B., Gregg, R., Kilger, R., Laugier, F., Marimbeau, P., Ranta-aho, A., Riffard, C., Suyama, K., Thro, J. F., Yudkevich, M., Hesketh, K. & Sartori, E. International comparison of a depletion calculation benchmark devoted to fuel cycle issues. Results from the Phase 1 dedicated to PWR-UOx fuels. In: PHYSOR-2006: Advances in nuclear analysis and simulation. September 10–14, 2006, Vancouver, British Columbia, Canada. [CD-ROM] La Grange Park: American Nuclear Society, 2006. Paper D142, 10 p. ISBN 0-89448-697-7.

Räty, H. TRAB-3D calculation of Olkiluoto 1 load rejection test June 16, 1998. NKS-R 3D BWR Transient Methodology Seminar. April 8, 2003, Espoo, Finland.

Serén, T. 25 years of surveillance dosimetry for the Loviisa reactors – highlights and trends. In: Proceedings of the 11th Meeting on Reactor Physics Calculations in the Nordic Countries. April 9–10, 2003, Espoo, Finland & m/s Romantika. VTT Symposium 230, Espoo, 2003. Pp. 165–175. ISBN 951-38-6286-0. <http://virtual.vtt.fi/inf/pdf/symposiums/2003/S230.pdf>.

Siltanen, P., Kaloinen, E. & Wasastjerna, F. Simulation of reactor scram experiments in the Loviisa and Mochovce VVER reactors. In: Proceedings of the 11th Meeting on Reactor Physics Calculations in the Nordic Countries. April 9–10, 2003, Espoo, Finland & m/s Romantika. VTT Symposium 230, Espoo, 2003. Pp. 123–138. ISBN 951-38-6286-0. <http://virtual.vtt.fi/inf/pdf/symposiums/2003/S230.pdf>.

Syrjälähti, E. & Miettinen, J. Hot channel calculation method for the sensitivity studies and hot rod analysis. In: Proceedings of the 14th Symposium of AER on VVER Reactor Physics and Reactor Safety. September 13–17, 2004, Espoo, Finland & m/s Silja Symphony. Budapest: Atomic Energy Research (AER), 2004. Pp. 529–541. ISBN 963-372-631-X.

Syrjälähti, E. & Hämäläinen, A. HEXTRAN-SMABRE calculation of the VVER-1000 coolant transient benchmark. In: NURETH-11: 11th International Topical Meeting on Nuclear Reactor Thermal Hydraulics. Avignon, France, October 2–6, 2005 [CD-ROM]. La Grange Park: American Nuclear Society, 2005. Paper 450. 12 p. ISBN 2-9516195-0-2.

Syrjälähti, E. New sensitivity analysis tool for VTT’s reactor dynamic codes. International Youth Nuclear Congress IYNC 2006. June 18–23, 2006, Stockholm, Sweden and Olkiluoto, Finland. Paper No. 181. 11 p.

Wasastjerna, F. Importances for MCNP calculations on a shield with a penetration. The American Nuclear Society’s 14th Biennial Topical Meeting of the Radiation Protection and Shielding Division. April 3–6, 2006, Carlsbad, New Mexico, USA. [CD-ROM] La Grange Park: American Nuclear Society, 2006. Pp. 478–488. ISBN 0-89448-693-4.

Research institute reports

Daavittila, A. 3D analysis methods – study and seminar. Includes the proceedings of the NKS-R 3D BWR Transient Methodology Seminar, Espoo, April 8, 2003. Roskilde: NKS Secretariat, 2003. 13 p. + 101 p. presentations. (NSK-89). ISBN 87-7893-147-9.

http://130.226.56.167/nordisk/publikationer/1994_2004/NKS-89.pdf.

Daavittila, A., Höglund, R., Kaloinen, E., Kotiluoto, P., Miettinen, J., Rajamäki, M. & Rätty, H. Status of the reactor analysis code development within the EMERALD project at the end of 2004, VTT Processes, Project report PRO1/P1001/05, 19.1.2005. 18 p.

Hämäläinen, A. Definition of VVER-1000 pressure vessel mixing for SMABRE, VTT, Research report VTT-R-01325-06, 8.2.2006. 11 p.

Höglund, R. (ed.). Reactor physics calculations in the Nordic countries. Proceedings of the 11th Nordic Reactor Physics Meeting, Espoo & m/s Romantika, April 9–10, 2003. VTT Symposium 230. 175 p. + app. 5 p. ISBN 951-38-6286-0; ISSN 1455-0873. <http://virtual.vtt.fi/inf/pdf/symposiums/2003/S230.pdf>.

Höglund, R. The Nordic reactor physics meetings 1983–2003. VTT Processes, Project report PRO1/P7026/03, 31.12.2003. 32 p.

Höglund, R. (ed.). Status of the reactor analysis code development within the EMERALD project at the end of 2004, VTT, Research report PRO1/P1001/05, 19.1.2005. 21 p.

Höglund, R. (ed.). Status of the reactor analysis code development within the EMERALD project at the end of 2005, VTT, Research report VTT-R-1033-06, 31.1.2006. 11 p. + app. 12 p.

Inkinen, P. 3D-dynamiikkaohjelmien tulosten visualisointi Matlabilla, VTT Processes, Project report PRO1/P1017/05, 24.8.2005. 21 p. + app. 2 p. (In Finnish).

Kaloinen, E. Input instructions of HEXBU-3D/MOD5&6, VTT Processes, Project report PRO1/P1027/05, 21.12.2005. 32 p.

Kaloinen, E. CRFIT7&8, codes for creation of input file of two-group diffusion parameters and fitting coefficients for HEXBU-3D/MOD5, HEXTRAN and TRAB-3D, VTT, Research report VTT-R-03225-06, 27.3.2006. 12 p. + app. 3 p.

Leppänen, J. Impact of base nuclear data libraries on results of MCNP criticality calculations. VTT Processes, Project report PRO1/P7018/03, 1.9.2003. 25 p.

Leppänen, J. Systematic comparison of evaluated nuclear data files, VTT Processes, Project report PRO1/7009/04, 28.5.2004. 104 p.

Miettinen, J. & Rätty, H. Status of the EMERALD subtask for coupling of TRAB-3D and SMABRE. VTT Processes, Project report PRO1/P7020/03, 30.9.2003. 8 p.

Miettinen, J. & Rätty, H. Status of the EMERALD subtask for coupling of TRAB-3D and SMABRE, VTT, Research report VTT-R-00982-06, 31.1.2006. 9 p.

Proceedings of the fourteenth Symposium of AER, Espoo, Finland and Baltic Sea Cruise to Stockholm, 13–17 September, 2004. Kiadja a KFKI Atomenergia Kutatóintézet, Budapest, November 2004. 732 p. + app. 9 p.

Pusa, M. Reaktorifysikaaliset herkkyys- ja epävarmuusmenetelmät, VTT Processes, Project report PRO1/P1028/05, 30.12.2005. 51 p. + app. 5 p. (In Finnish).

Ranta-Aho, A. Validation of reactor physics codes for predictions of isotopic compositions of high burnup LWR fuels, VTT Processes, Project report PRO1/P7006/04, 1.2.2004. 147 p.

Ranta-Aho, A. PWR-UO₂ assembly: study of control rods effects on spent fuel composition, VTT Processes, Project report PRO1/P1002/05, 11.1.2005. 37 p.

Syrjälähti, E. Development of the HEXTRAN program in connection with the VVER-1000 coolant transient benchmark, VTT Processes, Project report PRO1/P1004/05, 14.1.2005. 9 p.

Syrjälähti, E. New sensitivity analysis tool for the reactor dynamics codes, VTT Processes, Project report PRO1/P1016/05, 6.6.2005. 9 p. + app. 26 p.

Syrjälähti, E. Reaktoridynamiikkaohjelmien polttoainemallien kehittäminen, VTT Processes, Project report PRO1/P1019/05, 26.8.2005. 5 p. (In Finnish).

Others

Leppänen, J. Systematic comparison of evaluated nuclear data files, Licentiate's thesis, Helsinki University of Technology, Department of Engineering, Physics and Mathematics, 2004. 104 p.

Ranta-Aho, A. Testing of a rehomogenization model for a reactor simulator. Special assignment, Helsinki University of Technology, Department of Engineering, Physics and Mathematics, 1.4.2003. 29 p.

Ranta-Aho, A. Validation of reactor physics codes for predictions of isotopic compositions of high burnup LWR fuels, Master's thesis, Helsinki University of Technology, Department of Engineering Physics and Mathematics, 14.1.2004. 147 p.

Papers in review or in print

Kliem, S., Danilin, S., Hämäläinen, A., Hádek, J., Keresztúri, A. & Siltanen, P. Qualification of coupled 3D neutron kinetic/thermal hydraulic code systems by the calculation of main steam line break benchmarks in a NPP with VVER-440 reactor. (To be published in Nuclear Science and Engineering).

Kotiluoto, P. Adaptive tree multigrids and spherical harmonics approximation in deterministic neutral and charged particle transport. Doctor's thesis. (To be published).

High-burnup upgrades in fuel behaviour modelling (KORU):

Conference papers

Kelppe, S. J. KORU project summary report. In: Rätty, H. & Puska, E. K. (eds.). SAFIR, The Finnish Research Programme on Nuclear Power Plant Safety 2003–2006, Interim Report, VTT Research Notes 2272. VTT Processes. Espoo (2004). Pp. 46–51. ISBN 951-38-6515-0; ISSN 1235-0605. <http://virtual.vtt.fi/inf/pdf/tiedotteet/2004/T2272.pdf>.

Knuutila, A. Improvements on FRAPCON/FRAPTRAN mechanical modelling. In: Rätty, H. & Puska, E. K. (eds.). SAFIR, The Finnish Research Programme on Nuclear Power Plant Safety 2003–2006, Interim Report, VTT Research Notes 2272. VTT Processes. Espoo (2004). Pp. 52–58. ISBN 951-38-6515-0; ISSN 1235-0605. <http://virtual.vtt.fi/inf/pdf/tiedotteet/2004/T2272.pdf>.

Miettinen, J., Stengård, J.-O. & Kelppe, S. FRAPTRAN-GENFLO Calculations for the IFA-650 LOCA Test. Enlarged Halden Programme Group Meeting, Sandefjord, Norway, 9-14.5.2004.

Miettinen, J., Stengård, J.-O. & Kelppe, S. Application of the coupled thermalhydraulic – fuel behaviour code FRAPTRAN/GENFLO in LOCA test evaluations, OECD/CSNI Topical Meeting on LOCA issues and the SEGFSM Plenary Meeting. Argonne National Laboratory, May 24–26, 2004, USA.

Research institute reports

Miettinen, J., Stengård, J.-O., Vanttola, T. & Kelppe, S. Refined recalculations and parameter studies of the Halden IFA-650 LOCA test. VTT Processes Project Report PRO1/P7039/03, 2.4.2004. 38 p. + app. 16 p.

Seppälä, M. & Kelppe, S. Comparison of the FRAPCON-3 and ENIGMA code calculations in normal operation with statistical methods. VTT Processes Project Report PRO1/P7025/03, 8.12.2004. 38 p. + app.

Miettinen, J. Thermal hydraulics in the general flow model GENFLO. VTT Processes Project Report PRO1/P7012/03. 10.2.2005.

Seppälä, M. & Kelppe, S. FRAPCON-3 calculations on FUMEX II, case 27. VTT Processes Project Report PRO1/7027/04, 16.2.2005. 19 p.

Kekkonen, L., Seppälä, M. & Kelppe, S. Comparison of FUMEX II case 27 calculations as made with ENIGMA and FRAPCON-3 codes. VTT Processes Project Report PRO1/7028/04, 16.2.2005. 16 p. + app. 2 p.

Knuutila, A. Re-calibration of the ENIGMA Fission Gas Release Model: Part 1, VTT-R-05201-06, 26.6.2006.

Knuutila, A. Improvements on FRAPCON3/FRAPTRAN mechanical modelling. VTT-R-11337-06, 29.11.2006.

Knuutila, A., Pietarinen, K. Re-Calibration of the ENIGMA Fission Gas Release Model: Part 2, VTT-R-11655-06, 8.12.2006.

Kekkonen, L. Validation of the fission gas release model of the advanced IMAGINE code implemented in the ENIGMA fuel performance code. VTT-R-11757-06, 15.12.2006.

Others

Kekkonen, L. ENIGMA Calculations on FUMEX II Cases. Erikoistyö, Tfy-56.198 Energiateet. Teknillinen korkeakoulu, Teknillisen fysiikan koulutusohjelma. 10.12. 2004. 31 p. (In Finnish).

Kekkonen, L. Validation of the Fission Gas Release Model of the advanced IMAGINE Code Implemented in the ENIGMA Fuel Performance Code. M.Sc. Thesis. Helsinki University of Technology – Department of Engineering Physics and Mathematics, Espoo 20.12.2005. 68 p.

Kelppe, S. Tool and Methods – Fuel performance; lecture material in Basic professional training course on nuclear safety – National, Finland. September 2003 to February 2004.

Integrity and life time of reactor circuits (INTELI):

Scientific publications

Heerens, J., Ainsworth, R. A., Moskvic, R. & Wallin, K. Fracture toughness characterisation in the ductile-to-brittle transition and upper shelf regimes using pre-cracked Charpy single-edge bend specimen. *Pressure Vessels and Piping* 82(2005), pp. 649–667. (INSEL).

Laukkanen, A., Nevasmaa, P., Keinänen, H. & Wallin, K. Fracture toughness transferability study between the Master Curve method and a pressure vessel nozzle using local approach. Proceedings of the “2003 ASME Pressure Vessel and Piping Conference (ASME PVP2003)”. Cleveland, Ohio. July 2003. Ed. D.P. Lidbury. U.S.A.: The American Society of Mechanical Engineers (ASME), USA. 8 p.

Betova, I., Bojinov, M., Kinnunen, P., Mäkelä, K. & Saario, T. 2004. Conduction mechanism in oxide films on ferrous alloys studied by impedance spectroscopy in symmetrical and asymmetrical configurations. *Journal of Electroanalytical Chemistry*. Vol. 572, No. 2, pp. 211–223.

Laukkanen, A., Wallin, K., Nevasmaa, P. & Tähtinen, S. Transferability properties of local approach modeling in the ductile to brittle transition region. *Journal of ASTM International*, Jan. 2004, Vol. 1, No. 1, Paper ID JAI10618_11.

McCabe, D. E., Merkle, J. G. & Wallin, K. An Introduction to the Development and Use of the Master Curve Method. *Fatigue and Fracture, Manual 52*. ISBN:0-8031-3368-5, Stock#:MNL52. (INSEL).

Simola, K., Pulkkinen, U., Talja, H., Karjalainen-Roikonen, P. & Saarenheimo, A. Comparison of approaches for estimating pipe rupture frequencies for risk-informed in-service inspections. *Reliability Engineering & System Safety* 84 (2004), pp. 65–74.

Takeda, Y., Bojinov, M., Hänninen, H., Kinnunen, P., Laitinen, T., Mäkelä, K., Saario, T., Sakaguchi, K., Shoji, T., Sirkiä, P. & Toivonen, A. 2004. Comparison of the Electric Properties and ESCA result of Oxide Films Formed on AISI 316L NG Steel in Simulated BWR Conditions During SSRT. *Key Engineering Materials*. Vols. 261–263, pp. 925–930.

Vepsä, A., Haapaniemi, H., Luukkanen, P., Nurkkala, P. & Saarenheimo, A. Application of finite element model updating to a feed water pipeline of a nuclear power plant. *Nuclear Engineering and Design* 235 (2005), pp. 1849–1865. (INPUT).

Wallin, K. Warm pre-stress based pre-cracking criterion for fracture toughness testing. *Engineering Fracture Mechanics* 71 (2004), pp. 1737–1750.

Wallin, K., Nevasmaa, P., Laukkanen, A. & Planman, T. Master Curve analysis of inhomogeneous ferritic steels. *Engineering Fracture Mechanics* 71 (2004), pp. 2329–2346.

Wallin, K. & Laukkanen, A. Improved crack growth corrections for J-R-curve testing. *Engineering Fracture Mechanics* 71 (2004), pp. 1601–1614.

Valo, M., Ehrnstén, U., Kohopää, J., Debarberis, L., Kryukov, A. & Rintamaa, R. Dependence of re-embrittlement rate after annealing on the copper, nickel and phosphorus contents in model alloys. *Journal of ASTM International*, April 2004, Vol. 1, No. 4, ASTM International, pp. 164–178.

Wallin, K. Critical assessment of the standard ASTM E399. *Journal of ASTM International*, Vol. 2 (2005) No: 4, pp. 17–37.

Valo, M., Wallin, K., Lucon, E., Kytka, M., Brumovsky, M., Acosta, B., Debarberis, L., Kohopää, J., Gillemot, F. & Horvath, M. The Euratom 5th Framework Programme Project FRAME (fracture mechanics based embrittlement): description of the project and first results. *Nuclear Engineering and Design*, Vol. 235, Issues 2–4, February 2005. Pp. 445–455.

Wallin, K. & Laukkanen, A. Aspects of cleavage fracture initiation. *Fatigue & Fracture of Engineering Materials & Structures* Vol. 29 (2006) No: 9–10, pp. 788–798. (INSEL).

Conference papers

Betova, I., Bojinov, M., Kinnunen, P., Kivitörmä, M., Laitinen, T., Mäkelä, K., Saario, T. & Väyrynen, J. 2003. In-depth composition and conduction mechanism in the oxide film on stainless steel in a high-temperature aqueous electrolyte. Meeting Abstracts, 203rd Meeting of The Electrochemical Society, April 27 – May 2, 2003, Paris, France. The Electrochemical Society, Inc. Pennington, NJ, USA.

Calonius, K., Saarenheimo, A. & Pättikangas, T. Numerical analyses of a water pool under loading caused by large air and steam bubbles. VIII Suomen mekaniikkapäivät. 12.–13.6.2003, Espoo.

Calonius, K., Timperi, A., Pättikangas, T. & Solin, J. Case study on thermal fatigue potential in a T-joint, 3rd International Conference on Fatigue of Reactor Components, 3.–6.10.2004, Seville, Spain.

Cronvall, O. Risk and lifetime analysis methods for structural systems and components of power plants. VIII Suomen mekaniikkapäivät. 12.–13.6.2003, Espoo.

Cronvall, O., Saarenheimo, A., Simola, K. & Talja, H. Approaches to estimate pipe failure rates for risk-informed in-service applications at nuclear power plants, ESReDA 25th Seminar: Lifetime Management of Structures. France, Paris, 17.–18.11.2003.

Ehrnstén, U., Gomez-Briceno, D., Lapena, J., Ernestova, M., Zamboch, M., Ritter, S., Seifert, H.-P., Roth, A., Föhl, J., Hüttner, F. & Weissenberg, T. Inter-laboratory crack growth test on pressure vessel steel 20 MnMoNi5 5 in simulated BWR environment. 11th Int. Conf. on Environmental Degradation of Materials in Nuclear Power Systems – Water Reactors. USA, Washington 10–14.8.2003.

Ehrnstén, U., Aaltonen, P., Heltimoinen, M., Hietanen, O. & Hytönen, Y. Indications in radiation shielding plates and fixing bolts in Loviisa 2 PWR. EPRI Workshop on Fracture Toughness & Crack Growth in Irradiated BWR Internal Components Made of Austenitic Alloys. USA, Florida 19.–21.2.2003.

Nevasmaa, P., Laukkanen, A. & Alhainen, J. Evaluation of risk of hydrogen cracking using a combined finite-difference to finite-element analysis and coupling to damage mechanics. 9th Int. Conference on the Mechanical Behaviour of Materials (ICM-9), Switzerland, Geneva May 25–29, 2003.

Takeda, Y., Bojinov, M., Hänninen, H., Kinnunen, P., Laitinen, T., Mäkelä, K., Saario, T., Sakaguchi, K., Shoji, T., Sirkiä, P. & Toivonen, A. Electric properties and ESCA result of oxide films formed on AISI 316L NG steel and their implications to the crack initiation. ICG-EAC 2003, Canada, Ottawa May 11–16, 2003.

Takeda, Y., Bojinov, M., Hänninen, H., Kinnunen, P., Laitinen, T., Mäkelä, K., Saario, T., Sakaguchi, K., Shoji, T., Sirkiä, P. & Toivonen, A. Effect of Strain on Electric Properties of Oxide Films Growing on AISI 316L Steel in Simulated BWR Conditions, 11th International Conference on Environmental Degradation of Materials in Nuclear Power Systems – Water Reactors. USA, Washington, August 10–14, 2003.

Takeda, Y., Bojinov, M., Hänninen, H., Kinnunen, P., Laitinen, T., Mäkelä, K., Saario, T., Sakaguchi, K., Shoji, T., Sirkiä, P. & Toivonen, A. Comparison of the Electric Properties and ESCA result of Oxide Films Formed on AISI 316L NG Steel in Simulated BWR Conditions During SSRT, 5th International Conference on Fracture & Strength of Solids. Tohoku University, Japan, Sendai. October 20–22, 2003.

Takeda, Y., Bojinov, M., Hänninen, H., Kinnunen, P., Laitinen, T., Mäkelä, K., Saario, T., Sakaguchi, K., Shoji, T., Sirkkiä, P. & Toivonen, A. Effect of Strain and Strain Rate on the Electronic Properties of the Oxide Film growing on an Austenitic Stainless Steel in Simulated BWR conditions. The 47th Japan Congress on Materials Research. Japan, Kyoto, October 29–30, 2003.

Kauppinen, P. Paussu, R., Sarkimo, M. & Pitkänen, J. Qualification of ultrasonic inspection of austenitic piping by practical trials with test blocks containing defects. 8th International Conference on Material I in Design, Manufacturing and Operation of Nuclear Power Plants Equipment, St.Petersburg, Russia, 14–18.6.2004.

Pitkänen, J., Lipponen, A. & Kauppinen, P. Putkien tarkastukseen käytettävät NDT-menetelmät. Baltica VI – seminaari: Voimalaitosten kunnossapidon kokemukset ja kehittyvät menetelmät. Helsinki – Tukholma 8.–9.6.2004.

Pitkänen, J., Lipponen, A. & Kauppinen, P. Applicable methods for NDT of tubes. Baltica VI, International Conference on Life Management and Maintenance for Power Plants. Helsinki – Stockholm – Helsinki. 8 – 10 June, 2004.

Sarkimo, M. Simulointi ultraäänitarkastuksen suunnittelussa ja pätevyinnissä. Baltica VI – seminaari: Voimalaitosten kunnossapidon kokemukset ja kehittyvät menetelmät. Helsinki – Tukholma 8.–9.6.2004.

Solin, J., Karjalainen-Roikonen, P., Arilahti, E. & Moilanen, P. Low cycle fatigue behaviour of 316 NG alloy in PWR environment. Proceedings of 3rd International Conference on Fatigue of Reactor Components. Sevilla, Spain 3.–6.10.2004. EPRI/OECD. (INPUT).

Wallin, K. The misconception(s) of ASTM E399, plane-strain fracture toughness K_{IC}. Baltica VI, International Conference on Life Management and Maintenance for Power Plants. Helsinki – Stockholm – Helsinki. 8–10 June, 2004.

Wallin, K. Inhomogeneity check of the “Euro” fracture toughness reference data set. The 15th European Conference of Fracture Advanced Fracture Mechanics for Life and Safety Assessments. Stockholm, Sweden. 11–13 August 2004. (INSEL).

Aaltonen, P. Yagodzinskyy, Y. & Hänninen, H. Effects of Straining on Oxide Films and Passivity on Copper in Nitrite Solution at Ambient Temperature. Passivity-9, The Ninth international Symposium on the Passivation of Metals and Semiconductors and the Properties of Thin Oxide Layers. EFC Event n 281, Paris, France, June 27–July 1, 2005 (INCOM).

Ehrnstén U., Ivanchenko M., Nevdacha V., Yagodzinskyy Y, Toivonen A. & Hänninen, H. DYNAMIC STRAIN AGEING AND EAC OF DEFORMED NITROGEN-ALLOYED AISI 316 STAINLESS STEELS. 12th International Conference on Environmental Degradation of Materials in Nuclear Systems – Water Reactors. August 14–18, 2005, Snowbird Resort, Salt Lake City, Utah, USA. (INSEL).

Karlsen, W. & Aaltonen, P. Description of Mechanical Behavior of Irradiated Stainless Steel. Deliverable (D-No: C16). **Confidential**, 1.7.2005. (INPERF).

Roth, A., Devrient, B., Gómez-Briceno, D., Lapena, J., Ernestova, M., Zamboch, M., Ehrnstén, U., Föhl, J., Weissenberg, T., Scifert, H.-P. & Ritter, S. The effect of transients on the crack growth behavior of low alloy steels for pressure boundary components under light water reactor operating conditions. 12th International Conference on Environmental Degradation of Materials in Nuclear Power – Water Reactors. August 14–18, 2005, Snowbird Resort, Salt Lake City, Utah, USA. (INSEL).

Serén, T. & Wasastjerna, F. Extensive revision of the Kernel-based PREVIEW program and its input data. 12th Int. Symposium on Reactor Dosimetry. Gatlinburg, Tennessee, USA. 7.–13.5.05 (INSEL).

Toivonen, A., Ehrnstén, U., Karlsen, W., Aaltonen, P., Massoud, J.-P. & Boursier, J.-M. Fractographic Observations on a Highly Irradiated AISI 304 Steel after Constant Load Tests in Simulated PWR Water and Argon and after Supplementary Tensile and Impact Tests. 12th International Conference on Environmental Degradation of Materials in Nuclear Systems – Water Reactors. August 14–18, 2005, Snowbird Resort, Salt Lake City, Utah, USA. (INSEL).

Wallin, K., Keim, E., Bugat, S., Diard, O., Marini, B. & Viehrig, H.-W. PERFECT (Prediction of irradiation damage effects in reactor components): Overview of RPV Mechanics Sub-Project. Proceedings of ASME PVP 2005. ASME Pressure Vessel and Piping Division Conference. Denver, Colorado, USA. 17.–21.7.05 (INSEL).

Wallin, K. & Rintamaa, R. Use of the Master Curve Methodology for Real Three Dimensional Cracks. SMiRT 18, 18th Int. Conference on Structural Mechanics in Reactor Technology. Beijing, China, 7.–12.8.05 (INSEL).

Yagodzinsky, Y., Aaltonen, P. & Hänninen, H. Electrochemical Potential Oscillations during Galvanostatic Passivation of Copper in NaNO₂ Solutions and Their Role in RTGS-SCC Mechanism. Passivity-9, The Ninth international Symposium on the Passivation of Metals and Semiconductors and the Properties of Thin Oxide Layers. EFC Event n 281, Paris, France, June 27 – July 1, 2005. (INCOM).

Kauppinen, P., Cronvall, O., Sarkimo, M., Pättikangas, T., Bojinov, M., Kinnunen, P. & Saario, T. INTELI summary report. In: Rätty, H. & Puska, E. K. (eds.). SAFIR, The Finnish Research Programme on Nuclear Power Plant Safety 2003–2006, Interim Report, VTT Research Notes 2272. VTT Processes. Espoo (2004). Pp. 59–67. ISBN 951-38-6515-0; ISSN 1235-0605. <http://virtual.vtt.fi/inf/pdf/tiedotteet/2004/T2272.pdf>.

Laukkanen, A. & Wallin, K. Constraint corrected fracture mechanics in structural integrity assessment. In: Rätty, H. & Puska, E. K. (eds.). SAFIR, The Finnish Research Programme on Nuclear Power Plant Safety 2003–2006, Interim Report, VTT Research Notes 2272. VTT Processes. Espoo (2004). Pp. 52–67. ISBN 951-38-6515-0; ISSN 1235-0605. <http://virtual.vtt.fi/inf/pdf/tiedotteet/2004/T2272.pdf>.

Solin, J., Karjalainen-Roikonen, P., Arilahti, E. & Moilanen, P. Fatigue behaviour of 316 NG stainless steel in EPR primary circuit conditions. In: Rätty, H. & Puska, E. K. (eds.). SAFIR, The Finnish Research Programme on Nuclear Power Plant Safety 2003–2006, Interim Report, VTT Research Notes 2272. VTT Processes. Espoo (2004). Pp. 76–88. ISBN 951-38-6515-0; ISSN 1235-0605. <http://virtual.vtt.fi/inf/pdf/tiedotteet/2004/T2272.pdf>.

Ehrnstén, U. & Hänninen, H. TTK. Environmentally Assisted Cracking of Non-sensitised Stainless Steels – Possible Affecting Phenomena. Contribution of Materials Investigations to Improve the Safety and Performance of LWRs, Fontevraud-6, Fontevraud Royal Abbey, France 18–22 September 2006.

Kauppinen, P., Jeskanen, H. & Paussu, R. Ultrasonic inspection of bimetallic welds of the primary circuit components and piping of VVER-reactors, The Ninth International Conference Material Issues in Design, Manufacturing and Operation of Nuclear Power Plants Equipment, St. Petersburg, Russia 6–8 June 2006. Central Research Institute of Structural Materials “Prometey” in co-operation with the international Atomic Energy Agency and Institute for Energy of Joint Research Center of European Commission.

Paussu, R. & Pitkänen, J. Study for UT Qualification of Dissimilar Weld of Pressurizer Surge Line Nozzles, ECNDT 2006 – Fr.2.5.4.

Pitkänen, J. SAFT – Is it a Tool for Improved Sizing in Ultrasonic Testing? 9th European Conference on NDT, ECNDT 2006 – Poster 211, Berlin September 25–29, 2006.

Pitkänen, J., Laukkanen, A., Kemppainen, M. & Virkkunen, I. Effect of Stress on Ultrasonic Response in Detection and Sizing of Cracks. 9th European Conference on NDT, ECNDT 2006, Berlin September 25–29, 2006.

Virkkunen, I., Kemppainen, M. & Pitkänen, J. Effect of Crack Opening on UT response, 9th European Conference on NDT, ECNDT 2006 – Th.4.4.2, Berlin September 25–29, 2006.

Research Institute Reports

Ari-Lahti, E., Bojinov, M., Hansson-Lyyra, L., Kinnunen, P., Moilanen, P., Mäkelä, K., Saario, T. & Sirkiä, P. A pneumatic bellows-driven setup for controlled-distance electrochemical impedance measurements of Zircaloy-2 in simulated BWR conditions. Research Report TUO76-033512, VTT Industrial Systems.

Bojinov, M., Kinnunen, P., Laitinen, T., Mäkelä, K., Saario, T., Sirkiä, P., Betova, I. & Zaharieva, N. Modification of the high temperature titration equipment to reach relevant temperature (288°C) and to maintain constant solution composition in studying the adsorption and surface complexation of species at the oxide film/coolant interface. Research Report BTUO76-031199, VTT Industrial Systems.

Cronvall, O. Numerical modelling of fatigue behaviour of austenitic stainless piping steels. Research Report BTUO72-031200, VTT Industrial Systems.

Keinänen, H., Laukkanen, A. & Nevasmaa, P. ADIMEW – Work Package 2: Material characterisation. Research Report TUO72-033337, VTT Industrial Systems. (Confidential).

Laitinen, T. & Mäkelä, K. Minimisation of Fe content in the feed water for the steam generators. Assessment of critical factors and tools to control the Fe input. Research Report TUO76-033209, VTT Industrial Systems.

Laukkanen, A. & Nevasmaa, P. State of the Art Methods for Leak-Before-Break Evaluation. Research Report BTUO72-031186, VTT Industrial Systems.

Sarkimo, M. NDT-tarkastusten mallinnus ja simulointi CIVA-ohjelmistolla. Tutkimusraportti BTUO77-031206. VTT Tuotteet ja tuotanto.

Talja, H. Assessment of steam generator tube integrity – aliterature study. Research Report BTUO72-021093, VTT Industrial Systems.

Timperi, A., Pättikangas, T., Calonius, K., Tuunanen, J., Poikolainen, J. & Saarenheimo, A. Numerical analyses of a water pool under loadings caused by a condensation induced water hammer. Research Report BTUO72-031198, VTT Industrial Systems.

Aaltonen, P., Pelli, R. & Ehrnsten, U. VVER Steam Generators Life Time. Research Report TUO73-043602, VTT Industrial Systems.

Bojinov, M., Hansson-Lyyra, L., Kinnunen, P., Moilanen, P., Saario, T. & Sirkiä, P. Electrochemical impedance measurements of the oxidation of Zircaloy-4 in simulated PWR conditions with a pneumatic bellows-driven setup. Research Report BTUO73-041305, VTT Industrial Systems. (INSEL).

Bojinov, M., Kinnunen, P., Saario, T. & Sirkiä, P. Corrosion – water chemistry interaction studies in the INTELI-project in 2004. Research Report BTUO75-041288, VTT Industrial Systems (INSEL).

Cronvall, O. & Sarajärvi, U. Treatment and numerical simulation of fatigue data for austenitic stainless piping steels. Research Report BTUO72-041317, VTT Industrial Systems. (INPUT).

- Hakkarainen, T. The applicability of TOFD-ultrasonic technique for characterization of welds in piping components. Research Report TUO77-055249, VTT Industrial Systems. (INSEL).
- Ikonen, K. Crack propagation simulation in pipes by finite element method. Research Report PRO1P/7011/04. VTT Processes.
- Laukkanen, A. Boundary element method founded inference of local approach parameters. Research Report BTUO72-041260, VTT Industrial Systems.
- Moilanen, P. Pneumatic servo-controlled material testing device capable of operating at high temperature water and irradiation conditions. Doctoral thesis. VTT Publications 532, Espoo 2004. 154 p. ISBN 951-38-6384-0; 951-38-6385-9. <http://virtual.vtt.fi/inf/pdf/publications/2004/P532.pdf>.
- Pelli, R., Ehrnstén, U. & Aaltonen, P. Literature review on materials performance in modern steam generators. Research Report BTUO73-041219, VTT Industrial Systems.
- Pitkänen, J. NESC III PRT Ultraäänimittaukset, Tutkimusraportti BTUO77-041213. VTT Tuotteet ja tuotanto.
- Pitkänen, J. Paineastian vikojen etsintä ja karakterisointi ultraäänitarkastuksessa. Tutkimusraportti BTUO77-051330. VTT Tuotteet ja tuotanto.
- Pitkänen, J., Lipponen, A. & Kauppinen, P. Applicable methods for NDT -inspections of the tubes. Research Report BTUO77-041217, VTT Industrial Systems.
- Wallin, K. & Planman, T. Master Curve implementation for component assessment. AMES Thematic network on ageing (ATHENA), work package 3, Final Report. Research Report TUO72-044798, VTT Industrial Systems.
- Pättikangas, T., Timperi, A., Niemi, J. & Narumo, T. Fluid-Structure Interaction Analysis of a Water Pool under Loading Caused by a Xondensation Induced Water Hammer. Research Report BTUO72-051332, VTT Industrial Systems. (INPUT).
- Sarkimo, M. & Lipponen, A. Simulointiohjelmistolla tehty tarkastelu vian kallistuskulman vaikutuksesta ultraäänitarkastuksessa saatavaan kaikukorkeuteen. Research Report BTUO77-051319, VTT Industrial Systems. (INPUT).
- Simola, K., Holmberg, J.-E., Cronvall, O., Männistö, I. & Vepsä, A. RI-ISI pilot study of the Shut-down cooling system of the Olkiluoto 1/2 NPP units. Research Report BTUO72-051318, VTT Industrial Systems (INPUT).
- Solin, J., Karjalainen-Roikonen, P., Arilahti, E. & Moilanen, P. Fatigue behaviour of 316NG stainless steel in EPR primary circuit conditions. VTT Tiedotteita 2272. Pp. 76–88. ISBN 951-38-6515-0; 951-38-6516-9 ISSN 1235-0605. <http://www.vtt.fi/inf/pdf/tiedotteet/2004/T2272.pdf>.
- Toivonen, A. Stress corrosion crack growth rate measurement in high temperature water using small preracked bend specimens. Doctoral thesis. 2004. VTT Industrial Systems, Espoo. VTT Publications 531. 206 p. + app. 9 p. ISBN 951-38-6382-4; 951-38-6383-2. <http://virtual.vtt.fi/inf/pdf/publications/2004/P531.pdf>.
- Hakkarainen, T. Pitch-and-catch-tekniikan soveltuvuus virheiden koon määrittämiseen ja raekohinan havaitsemiseen. VTT Research report VTT-S-00780-06. 13 p. (In Finnish).
- Karlsen, W. & Nenonen, P. FEG-STEM Study of the 30 dpa CHOOZ A 304 SS. VTT Research Report VTT-R-01699-06 (INSEL).
- Kinnunen, P. Corrosion – water chemistry interaction studies in the INTELI-project in 2005. VTT Research Report TUO75-056404. (INPUT).

Pelli, R. Literature review on pressurisers. VTT Research Report VTT-R-01658-06. (INCOM)

Sarajärvi, U. & Cronvall, O. Simulation and analysis of data for enhancing low cycle fatigue test procedures. VTT Research Report TUO72-056604 (INPUT).

Sarkimo, M. Comparison of ultrasonic echo amplitudes from computer simulation and experimental measurements when different tilt and skew angles are applied. VTT Research Report BTUO77-051398. 20 p. (INPUT).

Vepsä, A. Vibration study of a secondary feed water pipeline RL61 of the Loviisa nuclear power plant. VTT Research Report VTT-R-00712-06. (INPUT).

LWR oxide model for improved understanding of activity build-up and corrosion phenomena (LWROXI):

Scientific publications

Bojinov, M., Kinnunen, P., Lundgren, K. & Wikmark, G. A Mixed-Conduction Model for the Oxidation of Stainless Steel in a High-temperature Electrolyte – estimation of kinetic parameters of oxide layer growth and restructuring. *Journal of the Electrochemical Society*, 152(7), (2005), pp. B250–B261.

Conference papers

Betova, I., Bojinov, M., Hansson-Lyyra, L., Kinnunen, P., Laitinen, T., Mäkelä, K. & Saario, T. Oxide films in high-temperature aqueous electrolytes characterised by impedance measurements in different configurations. Meeting Abstracts, 6th International Symposium on Electrochemical Impedance Spectroscopy, May 16 – May 21, 2004, Cocoa Beach, FL, USA. University of Florida. Gainesville, FL, USA (2004).

Bojinov, M., Kinnunen, P., Lundgren, K. & Wikmark, G. Passive film growth and oxide layer restructuring on stainless steel in a high-temperature borate electrolyte, PASSIVITY-9, the 9th International Symposium on the Passivation of Metals and Semiconductors, and the Properties of Thin Oxide Layers: A Selection of Papers from the 9th International Symposium, Paris, France, 27 June 1 July 2005. Elsevier. Oxford (2006). Pp. 397–440.

Bojinov, M. & Kinnunen, P. Kinetics of the growth and restructuring of the oxide layer on stainless steel in a light water reactor coolant. In: Rätty, H. & Puska, E. K. (eds.). SAFIR, The Finnish Research Programme on Nuclear Power Plant Safety 2003–2006, Interim Report, VTT Research Notes 2272. VTT Processes. Espoo (2004). Pp. 89–98. ISBN 951-38-6515-0; ISSN 1235-0605.
<http://virtual.vtt.fi/inf/pdf/tiedotteet/2004/T2272.pdf>.

Research institute reports

Bojinov, M., Kinnunen, P., Lundgren, K. & Wikmark, G. 2004. Characterisation and modelling of oxide films on stainless steels and nickel alloys in light water reactors, Research report No. BTUO73-041285, VTT Industrial Systems. 142 p.

Bojinov, M., Kinnunen, V., Lehtovuori, T. & Saario, G. A conceptual four-layer model of the oxide layer on structural materials in LWRs with emphasis on the oxide-coolant interactions, Research report No. BTUO75-056405, VTT Industrial Systems. 25 p.

Papers and reports under review or in press

Bojinov, M., Kinnunen, P. & Lehtikoinen, J. Further development and quantification of the Mixed-Conduction Model of the oxide film emphasising surface complexation and reprecipitation 2006. VTT Industrial Systems, Espoo. Research report No. VTT-R-10369-06. (In progress).

Ageing of the function of the containment building (AGCONT):

Research institute reports

Orantie, K. Ageing of the function of containment. In: Rätty, H. & Puska, E. K. (eds.). SAFIR, The Finnish Research Programme on Nuclear Power Plant Safety 2003–2006, Interim Report, VTT Research Notes 2272. VTT Processes. Espoo (2004). Pp. 98–104. ISBN 951-38-6515-0; ISSN 1235-0605. <http://virtual.vtt.fi/inf/pdf/tiedotteet/2004/T2272.pdf>.

Orantie, K. Suojarakennustoiminnon ikääntyminen – State of the Art. Espoo: VTT Building Technology. Report RTE40-IR-19/2003. 16 p.

Orantie, K. Suojarakennustoiminnon ikääntyminen – State of the Art. Espoo: VTT Building Technology. Report RTE40-IR-25/2004. 25 p.

Concrete Technological Studies Related to the Construction, Inspection and Reparation of the Nuclear Power Plant Structures (CONTECH):

Conference papers

Kuosa, H., Laukkanen, K., Pitkänen, P., Salparanta, L. & Vesikari, E. CONTECH summary report. In: Rätty, H. & Puska, E. K. (eds.). SAFIR, The Finnish Research Programme on Nuclear Power Plant Safety 2003–2006, Interim Report, VTT Research Notes 2272. VTT Processes. Espoo (2004). Pp. 105–109. ISBN 951-38-6515-0; ISSN 1235-0605. <http://virtual.vtt.fi/inf/pdf/tiedotteet/2004/T2272.pdf>.

Research institute reports

Salparanta, L. & Leivo, M. Siltoihin käytettävien raudoitustankojen sallittu ruostemäärä (Allowable extent of rusting of concrete reinforcement for new construction). Espoo: VTT Building Technology. Report RTE715/03. 11 p. + app. 1 p.

Salparanta, L. Raudoitteiden kunnan tarkastus. (Reinforcement inspection). Espoo: VTT Building Technology. Internal Report. RTE40-IR-2/2003. 7 p.

Salparanta, L. & Leivo, M. Jyrsinnän vaikutus siltakannen betoniin. (Effect of milling on concrete surface). Espoo: VTT Building Technology. Report RTE4540/03. 14 p.

Kuosa, H. & Leivo, M. Sulatussuolojen kerääntyminen betoniin. (Accumulation of salts into concrete). Espoo: VTT Building Technology. Report RTE2256/03. 46 p.

Pitkänen, P. Betonirakenteiden halkeilun hallinta. Espoo: VTT Building Technology. Report RTE257/04. 20 p. (In Finnish).

Pitkänen, P. Kaivinpölyjen tarkastusputkien sementtijuotosten jäätymisvauriot. Espoo: VTT Building Technology. Report RTE4309/04. 5 p. + app. 1 p. (In Finnish).

Salparanta, L. Betonin hiekkapuhallus vettähylykivää impregnointia ja tiivistystä varten. Espoo: VTT Building Technology. Report RTE2725/04. 9 p. (In Finnish).

Salparanta, L. Nestemäisen kalvon muodostavien jälkihoitoaineiden laatuvaatimukset. Espoo: VTT Building Technology. Report RTE3442/04. 37 p. (In Finnish).

Pitkänen, P. Rappeutumisen vaikutukset betonisillan kantokykyyn. Espoo: VTT Building Technology. Report RTE758/05. 29 p. (In Finnish).

Vesikari, E. BTB projekti. Yhteenvetoraportti (BTB project. Summary report). Espoo: VTT Building Technology. Internal Report. RTE40-IR-16/2004. 55 p. + app. 19 p.

Salparanta, L. Betonin hiekkapuhallus vettähylykivää impregnointia ja tiivistystä varten. Espoo: VTT Building Technology. Research Report RTE3253/05. 18.10.2005. 5 p. (In Finnish).

Salparanta, L. Betonin suoja-aineiden SILKO-hyväksymiskokeet. Espoo: VTT Building Technology. Research Report Nro RTE2206/05. 3.6.2005. 20 p. + app. 4 p. (In Finnish).

Pitkänen, P. Muotoiluvalun ongelmat ja laatuvaatimukset. Espoo: VTT Research Report Nro VTT-S-02259-06. 2.3.2006. 27 p. (In Finnish).

Pitkänen, P. Erittäin nopeasti kovettuvan juotoslaastin kokeet. Espoo: VTT Research Report VTT-S-10395-06. 3.11.2006. 7 p. (In Finnish).

Salparanta, L. Nestemäisiltä kalvon muodostavilta betonin jälkihoitoaineilta vedenpidätyskyvyn lisäksi vaadittavat ominaisuudet Suomen sääolosuhteissa. Espoo: VTT. Research Report VTT-S-02575-06. 16.3.2006. 13 p. (In Finnish).

Räisänen, P. Kahden sillan kansilaattojen RH-seurantamittaukset. Espoo: VTT. Research report Nro VTT-S-09254-06. 4.10.2006. 25 p. + app. 2 p. (In Finnish).

Salparanta, L. Betonimassan sisäiset jälkihoitoaineet. Espoo: VTT. Research Report Nro VTT-S-09596-06. 23 p. (In Finnish).

Others

Betonin suoja-aineiden SILKO-kokeet. VTT. Espoo 2004. 17 p. (In Finnish).

SILKO-tests of protective agents for concrete. VTT Espoo 2004. 16 p.

Kuivatuotebetonit, paikkauslaastit, paikkausmassat, juotoslaastit, juotosmassat, tasoitteet, kuivatuoteruiskubetonit ja ejektorilaastit – SILKO-kokeet. VTT. Espoo 2005. 9 p. (In Finnish).

Pre-mixed dry concretes, patch mortars and mastics, jointing grouts and mastics, screeds, pre-mixed dry shotcretes and air-blown mortars – SILKO-tests. VTT. Espoo 2005. 9 p.

Lisälehti julkaisuun Tiehallinnon selvityksiä 60/2001. 11 p. + app. 10 p. (In Finnish).

The Integration of Thermal-Hydraulics (CFD) and Structural Analyses (FEA) Computer Codes in Liquid and Solid Mechanics (MULTIPHYSICS):

Conference papers

Lestinen, V., Timperi, A. & Pättikangas, T. The integration of thermal-hydraulics (CFD) and structural analysis (FEM) computer codes in liquid and solid mechanics. In: Rätty, H. & Puska, E. K. (eds.). SAFIR, The Finnish Research Programme on Nuclear Power Plant Safety 2003–2006, Interim Report, VTT Research Notes 2272. VTT Processes. Espoo (2004). Pp. 124–131. ISBN 951-38-6515-0; ISSN 1235-0605. <http://virtual.vtt.fi/inf/pdf/tiedotteet/2004/T2272.pdf>.

Lestinen, V. & Toppila, T. Determination of Thermal-Hydraulic Loads on Reactor Internals in a DBA-situation. The 11th International Topical Meeting on Nuclear Reactor Thermal-Hydraulics (NURETH-11). Avignon, France. October 2005.

Lestinen, V., Toppila, T., Timperi, A., Pättikangas, T. & Hänninen, M. Determination of Thermal-Hydraulic Loads on Reactor Internals in a DBA-situation. Proceeding of PVP2006-ICPVT-11, 2006 ASME Pressure Vessels and Piping Division Conference. Vancouver, BC, Canada. July 2006.

Research institute reports

Pättikangas, T. & Timperi, A. CFD and structural analysis of the pressure transient in the beginning of a large-break LOCA in a PWR, VTT Industrial Systems, Report BTUO72-041302 (2004).

Timperi, A., Pättikangas, T. & Hänninen, M. Joint CFD-FEM Calculations of Pressure Transient in LBLOCA Using APROS, Star-CD and ABAQUS, VTT Research Report TUO72-056661, (2005). 67 p.

Others

Orivuori, S., Iivonen, P. & Kuikka, J. Propagation of Pressure Waves Taking Fluid-Structure Interaction into Account. ENPRIMA, Report EXP-6. 22. November 2004.

Lestinen, V. The Integration of Thermal-Hydraulic (CFD) and Structural Analysis (FEM) Computer Codes in Liquid and Solid Mechanics (MULTIPHYSICS). Fortum Nuclear Services, TERMO-437, 9 December 2004.

Lestinen, V., Timperi, A., Pättikangas, T., Saarenheimo, A., Iivonen, P. & Orivuori, S. MULTIPHYSICS, Integrated Thermal-Hydraulics and Structural-Analysis Computer Code Calculations in Nuclear Reactor Technology. Final Report in SAFIR project 2004.

Papers in review or in print

Lestinen, V. Joint CFD-FEM Calculations of Pressure Transient in LBLOCA Using FLUENT and ABAQUS, Fortum Nuclear Services Ltd., TERMO-515, (2006).

**The Integral Code for Design Basis Accident Analysis (TIFANY) 2003:
APROS modelling of containment pressure suppression systems (TIFANY) 2004:
Development of APROS containment model (TIFANY) 2005:
Validation of APROS containment model (TIFANY) 2006:**

Conference papers

Salminen, K. TIFANY summary report. In: Rätty, H. & Puska, E. K. (eds.). SAFIR, The Finnish Research Programme on Nuclear Power Plant Safety 2003–2006, Interim Report, VTT Research Notes 2272. VTT Processes. Espoo (2004). Pp. 132–139. ISBN 951-38-6515-0; ISSN 1235-0605.
<http://virtual.vtt.fi/inf/pdf/tiedotteet/2004/T2272.pdf>.

Research institute reports

Eskola, E. Description and Testing of the Generic PWR Primary Circuit Model for APROS 5.03, FNS Report TERMO-276 (confidential), Fortum Nuclear Services, 18 December 2003. 18 p.

Harti, M. Validation of the APROS 5.06 containment internal spray system model against International Standard Problem No. 35. Report TERMO-497, Fortum Nuclear Services, 7 December 2005. 33 p. + app. 30 p.

Harti, M. Modelling of temperature stratification with APROS in low flow conditions in large water pool. Report TERMO-499 (confidential), Fortum Nuclear Services, 23 January 2006. 13 p. + app. 5 p.

Henttonen, T. Bubbler Condenser Model for APROS 5.04, FNS Report TERMO-345 (confidential), Fortum Nuclear Services, 22 September 2004. 29 p.

Henttonen, T. Benchmark of APROS Bubbler Condenser Model against CONTAIN calculations, FNS Report TERMO-440 (confidential), Fortum Nuclear Services, 23 February 2004. 36 p.

Hänninen, M. Validation of APROS containment Model Against Marviken Test 18, VTT Research Report PRO5/7828/03 (confidential), VTT Processes, 9 December 2003. 14 p.

Hänninen, M., Silde, A. & Eerikäinen, L. Basic Validation of Containment and Six-equation Models, VTT Research Report PRO4/7831/03 (confidential), VTT Processes, 15 December 2003. 16 p.

Hänninen, M. & Ylijoki, J. The constitutive equations of the APROS six-equation model, VTT Research Report PRO5/7832/03 (confidential), VTT Processes, 7 January 2004. 35 p. + app. 3 p.

Hänninen, M. & Junninen, P. Improvements for condensation and gas convective heat transfer in six equation model of APROS. Research report VTT-R- 00890-06 (confidential), VTT Processes, 16 February 2006. 16 p.

Hänninen, M. Improvement of mass and heat transfer calculation in APROS containment model. Research report PRO1/1047/05 (confidential), VTT Processes, 23 August 2005. 26 p.

Hänninen, M. & Junninen, P. Steam separator model of APROS. Research report PRO1/1103/05, VTT Processes, 28 December 2005. 21 p.

Poikolainen, J. & Silde, A. Validation of the containment water pool stratification model of APROS against the POOLEX experiments STB-20 and STB-21. Research report PRO1/P1020/06, VTT Processes, 22 September 2005. 25 p. + app. 3 p.

Poikolainen, J. Validation of APROS 5.06 containment model against International Standard Problem No. 42 phase F. Research report VTT-R-10905-06, VTT, 24 November 2006. 24 p. + app. 2 p.

Routamo, T. Single node Ice Condenser Model for APROS (SIC), FNS Report TERMO-350, Fortum Nuclear Services, 11 January 2005.

Salminen, K. Validation of APROS Recombiner Model, FNS Report TERMO-275 (confidential), Fortum Nuclear Services, 21 October 2003. 17 p.

Salminen, K. Integrated Generic APROS Pressurized Water Reactor Model with Full Pressure Dry Containment, FNS Report TERMO-285 (confidential), Fortum Nuclear Services, 24 November 2003. 12 p.

Salminen, K. APROS 5.04 Calculation of the International Standard Problem No. 35 (ISP-35) – Validation of the APROS Containment Internal Spray System Model, FNS Research Report TERMO-286 (confidential), Fortum Nuclear Services, 19 December 2003. 17 p. + app. 2 p.

Silde, A. Correlations and Default Input Values of the Containment Model of APROS 5.04, VTT Research Report, PRO1/7056/03 (confidential), VTT Processes, 8 January 2004. 76 p.

Silde, A. Extension of internal spray modelling, and a new water film tracking model in containment model of APROS 5.06. Research report PRO1/1105/05 (confidential), VTT Processes, 31 January 2005. 49 p. + app. 3 p.

Ylijoki, J. Connection of Thermal Hydraulic and Containment Models in APROS, VTT Research Report PRO4/7806/03, VTT Processes, 10 February 2003. 20 p.

Ylijoki, J. Modelling of heat exchangers and heat structures of containment in APROS, VTT Research Report PRO5/7812/04 (confidential), VTT Processes, 29 December 2004. 13 p. + app. 36 p.

Ylijoki, J. Simulation model of Olkiluoto Nuclear Power Plant for APROS, VTT Research Report PRO5/7829/03 (confidential), VTT Processes, 18 December 2003. 23 p. + app. 26 p.

Ylijoki, J. Validation of APROS Model for Olkiluoto Nuclear Power Plant, VTT Research Report PRO5/7830/03 (confidential), VTT Processes, 18 December 2003. 28 p. + app. 5 p.

Ylijoki, J. APROS Model of the Steam Generator of an EPR Plant, VTT Research Report PRO5/7807/04 (confidential), VTT Processes, 7 October 2004. 16 p. + app. 15 p.

Ylijoki, J. Valves of the containment model of APROS. Research report PRO1/1040/05, VTT Processes, 18 August 2005. 37 p.

Thermal hydraulic analysis of nuclear reactors (THEA):

Scientific publications

Scheuerer, M., Heitsch, M., Menter, F., Egorov, Y., Toth, I., Bestion, D., Pigny, S., Paillere, H., Martin, A., Boucker, M., Krepper, E., Willemsen, S., Muhlbauer, P., Andreani, M., Smith, B., Karlsson, R., Henriksson, M., Hemstrom, B., Karppinen I. & Kimber, G. (2005). Evaluation of computational fluid dynamic methods for reactor safety analysis (ECORA). *Nuclear Engineering and Design*, Vol. 235 (2–4), pp. 359–368.

Conference papers

Miettinen, J. The Prediction of the LWR Plant Accident Based on the Measured Plant Data. In: ICONE-13: 13th International Conference on Nuclear Engineering. Beijing, China, May 16-20, 2005 [CD-ROM]. New York: American Society of Mechanical Engineers, 2005. Paper ICONE-13-50823.

Puska, E. K. & Norrman, S. Studies with large 3-D core models for simulator purposes. *Nuclear Mathematical and Computational Sciences: A Century in Review – A Century Anew*. Gatlingburg, Tennessee, April 6–11, 2003 [CD-ROM]. La Grange Park: American Nuclear Society, 2003. Paper 080. 13 p. ISBN 0-89448-674-8.

Tuomainen, M. Fluent simulation of lighter-than-steam non-condensable gas behaviour in vertical-tube heat exchanger. *Proceedings of International Congress on Advances in Nuclear Power Plants (ICAPP'03)*, May 4–7 2003, Cordoba, Spain. ISBN 0-89448-675-6.

Tuomainen, M. THEA summary report. In: Rätty, H. & Puska, E. K. (eds.). *SAFIR, The Finnish Research Programme on Nuclear Power Plant Safety 2003–2006, Interim Report*, VTT Research Notes 2272. VTT Processes. Espoo (2004). Pp. 140–146. ISBN 951-38-6515-0; ISSN 1235-0605. <http://virtual.vtt.fi/inf/pdf/tiedotteet/2004/T2272.pdf>.

Poikolainen, J. Simulation of the PACTEL Helium experiments with APROS 5.04. 6th International Seminar on Horizontal Steam Generators. Electrogorsk, Russia, March 21–25, 2004.

Poikolainen, J. Simulation of the PACTEL non-condensable experiments with APROS 5.04. In: Rätty, H. & Puska, E. K. (eds.). *SAFIR, The Finnish Research Programme on Nuclear Power Plant Safety 2003–2006, Interim Report*, VTT Research Notes 2272. VTT Processes. Espoo (2004). Pp. 147–152. ISBN 951-38-6515-0; ISSN 1235-0605. <http://virtual.vtt.fi/inf/pdf/tiedotteet/2004/T2272.pdf>.

Research institute reports

Huhtanen, R. & Niemi, J. Simulation of condensation on MISTRA facility using Fluent code, PRO1/P1030/05, 28.2.2006. 25 p.

Junninen, P. Simulating the Test PKL E3.1 with APROS, PRO1/P1029/05. 16.2.2006. 29 p.

Poikolainen, J. Simulation of the PACTEL non-condensable gas experiments NCg-3 and NCg-1 with APROS 5.04. PRO1/P7035/06. 30 p. + app. 3 p.

Takasuo, E. An Assessment of the TRACE V4.160 Code against the PACTEL ATWS-10–13 And ATWS-20–21 Pressurizer Experiments, PRO1-53T-05 (funded by Fortum and TVO).

Yrjölä V. & Holmström, H. Assessment of the RELAP5/mod3.2.2 code against the PACTEL steam generator collector rupture experiments PSL-10 and PSL-11, CAMP International Assessment Report, November 2005 (funded outside the THEA project).

Inkinen, P. ROSA/LSTF-koelaitteiston mallinnus APROS-ohjelmistolla, VTT-R-08258-06 (confidential).

Others

Junninen, P. Laskentamalli PKL-koelaitteiston pienen vuodon kokeen simuloimiseksi APROS ohjelmalla, Diplomityö, STUK- YTO-TR 214, elokuu 2005 (funded by STUK).

Takasuo, E. Modelling of pressurizer using APROS and TRACE thermal hydraulic codes, Master's thesis, Lappeenranta University of Technology, Department of Energy and Environmental Technology, 17.11.2005.

Hillberg, S. Ydinvoimalan paineakun mallinnus, Diplomityö, Lappeenranta teknillinen yliopisto, energia- ja ympäristötekniikan osasto, 9.10.2006.

Archiving experiment data (KOETAR):

Conference papers

Riikonen, V. KOETAR summary report. In: Rätty, H. & Puska, E. K. (eds.). SAFIR, The Finnish Research Programme on Nuclear Power Plant Safety 2003–2006, Interim Report, VTT Research Notes 2272. VTT Processes. Espoo (2004). Pp. 194–198. ISBN 951-38-6515-0; ISSN 1235-0605.
<http://virtual.vtt.fi/inf/pdf/tiedotteet/2004/T2272.pdf>.

Research institute reports

Riikonen, V. KOETAR-projektin tilannekatsaus 2003, LTY/ENTE/YTY, KOETAR 1/2003, 3.11.2003. 3 p.

Riikonen, V. KOETAR-projektin tilannekatsaus 2004, LTY/ENTE/YTY, KOETAR 1/2004, 7.12.2004. 6 p.

Riikonen, V. SAFIR/KOETAR-projektin yhteenveto, LTY/ENTE/YTY, KOETAR 1/2006, 16.10.2006. 11 p.

Others

Riikonen, V. Kokeiden arkistoinnin priorisointi 20.8.2003. 9 p. (In Finnish).

Condensation pool experiments (POOLEX):

Conference papers

Purhonen, H., Puustinen, M., Laine, J., Räsänen, A., Kyrki-Rajamäki, R. & Vihavainen, J. Steam Blowdown Experiments with the Condensation Pool Test Rig. International Conference Nuclear Energy for New Europe 2005, Bled, Slovenia, September 5–8, 2005. 10 p.

Puustinen, M. & Laine, L. Condensation pool experiments with steam injection. In: Rätty, H. & Puska, E. K. (eds.). SAFIR, The Finnish Research Programme on Nuclear Power Plant Safety 2003–2006, Interim Report, VTT Research Notes 2272. VTT Processes. Espoo (2004). Pp. 199–206. ISBN 951-38-6515-0; ISSN 1235-0605. <http://virtual.vtt.fi/inf/pdf/tiedotteet/2004/T2272.pdf>.

Research institute reports

Laine, J. & Puustinen, M. Preliminary Condensation Pool Experiments with Steam Using DN80 and DN100 Blowdown Pipes. Lappeenranta: Lappeenranta University of Technology, Nuclear Safety Research Unit, Research Report, 2003, (POOLEX 4/2003). 24 p. + app. 7 p.

Laine, J. & Puustinen, M. Preliminary Condensation Pool Experiments with Steam Using DN200 Blowdown Pipe. Lappeenranta: Lappeenranta University of Technology, Nuclear Safety Research Unit, Research Report, 2004, (POOLEX 1/2004). 30 p. + app. 6 p.

Puustinen, M., Räsänen, A. & Laine, J. Lauhdutusallaskokeissa käytettäväksi soveltuvien mittalaitteiden, tiedonkeruujärjestelmien ja visualisointitekniikoiden kartoitus. Lappeenranta: Lappeenranta University of Technology, Nuclear Safety Research Unit, Research Report, 2004, (POOLEX 2/2004). 26 p.

Laine, J. & Puustinen, M. Condensation Pool Experiments with Steam Using DN200 Blowdown Pipe. Lappeenranta: Lappeenranta University of Technology, Nuclear Safety Research Unit, Research Report, 2005, (POOLEX 4/2004). 41 p. + app. 4 p.

Laine, J. & Puustinen, M. Thermal Stratification Experiments with the Condensation Pool Test Rig. Lappeenranta: Lappeenranta University of Technology, Nuclear Safety Research Unit, Research Report, 2005, (POOLEX 1/2005). 23 p. + app. 8 p.

Laine, J. & Puustinen, M. Steam Blowdown Experiments on Chugging. Lappeenranta: Lappeenranta University of Technology, Nuclear Safety Research Unit, Research Report, 2005, (POOLEX 2/2005). 40 p. + app. 7 p.

Laine, J. & Puustinen, M. Condensation Pool Experiments with Steam Using Insulated DN200 Blowdown Pipe. Lappeenranta: Lappeenranta University of Technology, Nuclear Safety Research Unit, Research Report, 2005, (POOLEX 3/2005). 17 p. + app. 8 p.

Puustinen, M., Partanen, H., Laine, J., Räsänen, A. & Purhonen, H. Preliminary plan for a Condensation Pool Test Rig Including a Drywell. Lappeenranta: Lappeenranta University of Technology, Nuclear Safety Research Unit, Technical Report, 2006. 8 (POOLEX 4/2005). 8 p. + app. 1 p.

Others

Puustinen, M. & Partanen, H. Alustava POOLEX-esikokeiden laitteistosuunnitelma ja suoritusperiaate. Technical Report, POOLEX 1/2003. 5 p. + app. 2 p.

Räsänen, A. & Puustinen M. POOLEX-esikokeissa käytettävissä olevat mittaukset. Technical Report, POOLEX 2/2003. 8 p. + app. 2 p.

Laine, J. & Räsänen, A. POOLEX-esikokeiden mittausten kustannusten arviointia. Technical Report, POOLEX 3/2003. 4 p.

Puustinen, M. Test plan for detailed condensation pool experiments with DN200 blowdown pipe in 2004. Technical Report, POOLEX 3/2004. 10 p.

Nurminen, T. Passive Safety Features of VVER-640 Reactors. Master's thesis, Lappeenranta University of Technology. Lappeenranta, 2003. 80 p. (In Finnish).

Räsänen, A. Measurement system for steam condensation. Master's thesis, Lappeenranta University of Technology. Lappeenranta, 2004. 83 p. + app. 2 p. (In Finnish).

PACTEL OECD project planning (PACO, 2004):

Research institute reports

Purhonen, H., Kouhia, V. Proposal of PACTEL OECD project for OECD. Lappeenranta: Lappeenranta University of Technology, Nuclear Safety Research Unit, Research Report, 2004. (PACO 1/2004). 4 p. + app. 4 p.

Kouhia, V. & Purhonen, H. PACTEL OECD project planning. In: Rätty, H. & Puska, E. K. (eds.). SAFIR, The Finnish Research Programme on Nuclear Power Plant Safety 2003–2006, Interim Report, VTT Research Notes 2272. VTT Processes. Espoo (2004). Pp. 207–214. ISBN 951-38-6515-0; ISSN 1235-0605. <http://virtual.vtt.fi/inf/pdf/tiedotteet/2004/T2272.pdf>.

Papers and reports under review or in press

Kouhia, V. PACO Project, Summary on pre-analysis 2004-2005, Lappeenranta, Lappeenranta University of Technology, Nuclear Safety Research Unit, Research Report, 2006. YTY 1/2006. (In preparation).

Participation in development of European calculation environment (ECE, 2005–2006):

Others

Riikonen V. & Ilvonen M. PTS scenarios for Loviisa VVER-440 PWR, Lappeenranta University of Technology, 2005, (Technical Report NURESIM 1/2005).

Puustinen M. & Vihavainen J. Deliverable D2.1.2: Review of the existing data basis for the validation of models for PTS. Condensation Pool Experiment (LUT Data), Lappeenranta University of Technology, 2005 (Technical Report NURESIM 2/2005).

Turtiainen, K. Modelling of a Hydrogen Catalytic Recombiner for Nuclear Power Plant Containment Studies; Case: Siemens FR90/1-150 Recombiner Model in TONUS 0D Code. Lappeenranta 2005. (Lappeenranta University of Technology). MScTech thesis. 133 p. + app. 20 p.

Laine, J. & Puustinen, M. Condensation pool experiments with steam using insulated DN200 blowdown pipe. Lappeenranta: Lappeenranta University of Technology, Nuclear Safety Research Unit, Research Report, 2005, (POOLEX 3/2005). 17 p. + app. 8 p.

Papers and reports under review or in press

Riikonen, V. & Ilvonen, M. Identification of relevant PTS-scenarios, State of the art of modelling and needs for model improvements, European Commission 6th Euratom framework programme 2005–2008, Integrated project (IP): NURESIM, Nuclear Reactor Simulations, Sub-project 2: Thermal hydraulics, Deliverable D2.1.1. (To be published).

Vihavainen, J. & Puustinen, M. Review of the existing data basis for the validation of models for PTS, European Commission 6th Euratom framework programme 2005–2008, Integrated project (IP): NURESIM, Nuclear Reactor Simulations, Sub-project 2: Thermal hydraulics, Deliverable D2.1.2. (To be published).

Wall response to soft impact (WARSI) and Impact tests (IMPACT):

Conference papers

Kärnä, T. & Saarenheimo, A. IMPACT loaded structures. In: Rätty, H. & Puska, E. K. (eds.). SAFIR, The Finnish Research Programme on Nuclear Power Plant Safety 2003–2006, Interim Report, VTT Research Notes 2272. VTT Processes. Espoo (2004). Pp. 113–123. ISBN 951-38-6515-0; ISSN 1235-0605. <http://virtual.vtt.fi/inf/pdf/tiedotteet/2004/T2272.pdf>.

Saarenheimo, A. WARSI summary report. In: Rätty, H. & Puska, E. K. (eds.). SAFIR, The Finnish Research Programme on Nuclear Power Plant Safety 2003–2006, Interim Report, VTT Research Notes 2272. VTT Processes. Espoo (2004). Pp. 110–112. ISBN 951-38-6515-0; ISSN 1235-0605. <http://virtual.vtt.fi/inf/pdf/tiedotteet/2004/T2272.pdf>.

Saarenheimo, A., Hakola, I., Hyvärinen, J. & Tuomala, M. “Numerical and Experimental Studies on Impact Loaded Concrete Structures” Proc., of ICONE 14, International Conference on Nuclear Engineering. ICONE14-89477. July 17–20, 2006, Miami, USA.

Saarenheimo, A., Tuomala, M., Hakola, I., Hyvärinen, J., Aalto, A. & Myllymäki, J. Impacts of Deformable Missiles on Reinforced Concrete Walls, (accepted and to be presented in) CONSEC’07, Tours, France.

Research institute reports

Lautkaski, R. Combustion of fuel droplet clouds. VTT Processes, Project Report PRO1/P7022/04. Espoo 2004. 92 p.

Lautkaski, R. Deflagration to detonation transition. VTT Processes, Project Report PRO1/P1025/05. Espoo 2005. 43 p.

Saarenheimo, A., Aalto, A., Calonius, K., Hakola, I., Hostikka, S., Kankkunen, A., Kärnä, T., Silde, A. & Tuomala, M. Numerical studies for impact tests. VTT Industrial Systems, Research report BTUO72-051408, 27.2.2006. 81 p.

Saarenheimo, A., Aalto, A., Calonius, K., Myllymäki, J. & Tuomala, M. Wall Response to Soft Impact. VTT Industrial Systems Research Report TUO72-033533. Espoo 2004. 125 p.

Silde, A. Disintegration and atomization of liquid jet and sheet. VTT Processes Project Report No. PRO1/P7026/04. 53 p.

Silde, A., Hostikka, S. & Kankkunen, A. Liquid Release and Spreading from Projectile Impacting on Wall. Research Report VTT-R-01226-06. VTT. 28.3.2006.

Saarenheimo, A., Martikainen, H., Tuomala, M. & Vepsä, A. Preliminary studies for missile tests, VTT Industrial Systems Research Report No. BTUO72-041292. 92 p.

Silde, A., Lautkaski, R. & Huhtanen, R. Dispersion and combustion of jet fuel in aircraft crash into a multi-storey building. VTT Processes Project Report PRO5/7836/03. 69 p. + app. 8 p.

Hakola, I. & Kärnä, T. IMPACT TESTS, Testing facility. VTT. 15.12.2005.

Others

Eriksson E. 2005. The crushing forces of the missile body. MSc. Thesis. Tampere University of Technology.

Severe accidents and nuclear containment integrity (SANCY, 2003–2005):

Scientific Publications

Lindholm, I., Holmström, S., Miettinen, J., Lestinen, V., Hyvärinen, J., Pankakoski, P. H. & Sjövall, H. Dryout heat flux experiments with deep heterogeneous particle bed, *Nuclear Engineering and Design*, Vol. 236 (2006), pp. 2060–2074.

Conference Papers

Lindholm, I., Athken, K., Bürger, M., Fichot, F. & Park, S. In-Vessel Retention: On Going Activity on In-Vessel Core and Debris Coolability, Seminar ERMSAR First European Review Meeting on Severe Accident Research, 14–16 November, 2005, Aix en Provence, France.

Lindholm, I. SANCY summary report. In: Rätty, H. & Puska, E. K. (eds.). SAFIR, The Finnish Research Programme on Nuclear Power Plant Safety 2003–2006, Interim Report, VTT Research Notes 2272. VTT Processes. Espoo (2004). Pp. 153–159. ISBN 951-38-6515-0; ISSN 1235-0605. <http://virtual.vtt.fi/inf/pdf/tiedotteet/2004/T2272.pdf>.

Kanerva, P. Study of water ingress models. In: Rätty, H. & Puska, E. K. (eds.). SAFIR, The Finnish Research Programme on Nuclear Power Plant Safety 2003–2006, Interim Report, VTT Research Notes 2272. VTT Processes. Espoo (2004). Pp. 160–167. ISBN 951-38-6515-0; ISSN 1235-0605. <http://virtual.vtt.fi/inf/pdf/tiedotteet/2004/T2272.pdf>.

Joki, H. & Zilliacus, R. The irradiation tests of sealing materials. In: Rätty, H. & Puska, E. K. (eds.). SAFIR, The Finnish Research Programme on Nuclear Power Plant Safety 2003–2006, Interim Report, VTT Research Notes 2272. VTT Processes. Espoo (2004). Pp. 168–174. ISBN 951-38-6515-0; ISSN 1235-0605. <http://virtual.vtt.fi/inf/pdf/tiedotteet/2004/T2272.pdf>.

Research institute reports

Lindholm, I. & Sevón, T. Remaining uncertainties of severe accidents, Project report PRO1/P7019/03, 25.9.2003. 83 p.

Holmström, S., Pankakoski, P. H. & Hosio, E. STYX dryout heat flux testing with a constrained stratified bed, Research Report BTUO74-031179, 12.12.2003. 20 p.

Holmström, S., Pankakoski, P. H. & Hosio, E. STYX dryout heat flux testing with a dense top layer bed, Research Report BTUO74-031202, 30.1.2004. 30 p. + app. 2 p.

Joki, H., Zilliacus, R. & Nygård, M. The irradiation test of butyl rubber seals, Draft 2004.

Ikonen, K. Mechanical Analysis of Olkiluoto RPV Bottom in Core Melting Accident, VTT Processes Research Report PRO1/7017/04, 11.5.2004. 43 p. + app. 9 p.

Sevón, T. Molten Core-Concrete Interactions: Thermodynamics and simulations with MELCOR 1.8.5 Computer Code. VTT Processes Research Report PRO1/7026/04, 13.8.2004. 26 p. + app. 4 p.

Kokkonen, I. Permeability Measurements for STYX-5 Experiments, Fortum Nuclear Services, Report TERMO-305, April 13, 2004 10 p.

Holmström, S., Pankakoski, P. H., Hosio, E. STYX dry-out heat flux testing with a variable test bed thickness, VTT Industrial Systems, Research report No. BTUO74-041303, Dec. 2004. (To appear).

Kekki, T., Ziliacus, R. & Lindholm, I. Implementation of NUCLEA Database for In-Vessel and Ex-Vessel Nuclear Applications, VTT Project Report PRO1/P7018/04, 2.5.2005. 15 p. + app. 2 p.

Kekki, T., Ziliacus, R. & Lindholm, I. GEMINI Calculations for Loviisa and MET-1 Test Cases, VTT Project Report PRO1/P1024/05, 30.12.2005. 16 p. + app. 2 p.

Ziliacus, R. & Joki, H. The Irradiation Tests of Sealing Materials, VTT Project Report, VTT Project Report PRO1/P1006/05, 10.5.2005. 19 p.

Ziliacus, R. & Joki, H. The Irradiation Tests of Silicon Rubbers, VTT Research Report VTT-R-00899-16, 14.2.2006. 9 p.

Holmström, S., Pankakoski, P. H. & Hosio, E. STYX dryout heat flux testing with different test bed thicknesses – Part 1: The 200 and 400 mm test beds, Research Report BTUO74-41303, 11.1.2005. 14 p. + app. 4 p.

Holmström, S., Pankakoski, P. H. & Hosio, E. STYX dryout heat flux testing with different test bed thicknesses – Part 2: Homogeneous and stratified tests with 600 mm and 400 mm test beds, Research Report BTUO74-051381, 20.12.2005. 19 p. + app. 26 p.

Sevón, T. Molten Core – Concrete Interactions in Nuclear Accidents – Theory and Design of an Experimental Facility, VTT Research Notes 2311, November 2005. 83 p. ISBN 951-38-6743-9; 951-38-6744-7. <http://virtual.vtt.fi/inf/pdf/tiedotteet/2005/T2311.pdf>.

Others

Sevón, T. Höyryräjähdysket ydinvoimalaitosten suojarakennusolosuhteissa, erikoistyö (TKK, teknillisen fysiikan ja matematiikan osasto), 11.8.2003. 22 p.

Cavity phenomena and hydrogen burn (CAPHORN, 2006):

Research Institute reports

Sevón, T. Updating of Olkiluoto 1&2 BWR Model to MELCOR Version 1.8.6, Research Report VTT-R-08033-06, 11.9.2006. 25 p.

Sevón, T. Simulation of COMET-L2 Melt-Concrete Interaction Experiment with MELCOR, Research Report VTT-R-04325-06, 3.5.2005. 8 p.

Papers and reports under review or in press

Takasuo, E. & Kudriakov, S. Modeling of the FLAME hydrogen combustion tests F-8 and F-22 using the TONUS CFD code, Rapport DMS2 SFME/LTMF/RT/06-046/A, Commissariat à l'Énergie Atomique (CEA), France. 72 p. (To appear).

Fission product gas and aerosol particle control (FIKSU, 2003–2004):

Conference papers

Backman, U., Auvinen, A. & Jokiniemi, J. Behaviour of Ru in high temperature oxidising conditions. In: Proceedings of the AAAR Annual Conference 2003, Anaheim, USA, 20–24 Oct. 2003.

Jokiniemi, J. K. Auvinen, A., Bottomley, P. D. & Tuson, A. T. Revaporisation of deposited fission products from FPT1 samples: first conclusions. In: Proceedings of the 5th Technical seminar of the Phebus FP Programme, Aix-en-Provence, France, 24–26 June 2003.

Research institute reports

Backman, U., Lipponen, M., Auvinen, A., Jokiniemi, J. & Zilliacus, R. Ruthenium behaviour in severe nuclear accident conditions – final report. VTT Processes report PRO3/P27/04.

Auvinen A. & Jokiniemi J. Aerosol deposition into Phebus FPT-1 steam generator. VTT Processes Project Report PRO3/P11/03.

Backman, U., Zilliacus, R. & Jokiniemi, J. Ruthenium behaviour in severe nuclear accident conditions – facility setup. VTT Processes Project Report PRO3/TP7/03.

Backman, U., Zilliacus, R., Lipponen, M., Auvinen, A. & Jokiniemi, J. Ruthenium behaviour in severe nuclear accident conditions. VTT Processes Project Report PRO3/P28/03.

Backman, U., Lipponen, M., Zilliacus, R., Auvinen, A. & Jokiniemi, J. Ruthenium behaviour in severe nuclear accident conditions – progress report. VTT Processes Project Report PRO3/P73/03.

Backman, U., Lipponen, M., Zilliacus, R., Auvinen, A. & Jokiniemi, J. Ruthenium behaviour in severe nuclear accident conditions – progress report. VTT Processes Project Report PRO3/P74/03.

Others

Girault, N., Dickinson, S., Funke, F., Krausmann, E., Bruchertseifer, R., Cripps, R., Powers, D., Auvinen, A., Herranz, L., Caponetti, R. & Ogino, M. Phebus-FP Containment Chemistry Interpretation Circle FPT-1 Final Interpretation Report. Note technique DPAM/SEMIC n:o 2004/06, Sep. 2004.

Behaviour of fission products in air-atmosphere (FIKA, 2005–2006):

Scientific publications

Backman, U. Studies on nanoparticles synthesis via gas-to-particle conversion, Academic dissertation, University of Helsinki, Faculty of Science, Department of Physical Sciences, Espoo 2005. VTT Publications 562. 45 p. + app. 62 p. ISBN 951-38-6441-3; 951-38-6442-1.
<http://virtual.vtt.fi/inf/pdf/publications/2005/P562.pdf>.

Girault, N., Dickinson, S., Funke, F., Auvinen, A., Herranz, L. & Krausmann, E. Iodine behaviour under LWR accident conditions: Lessons learnt from analyses of the first two Phebus FP tests, *Nuclear Engineering and Design*, Vol. 236 (2006) No. 12, pp. 1293–1308.

Backman, U., Lipponen, M., Auvinen, A., Tapper, T., Zilliacus, R. & Jokiniemi, J. On the transport and speciation of ruthenium in high temperature oxidising conditions, *Radiochim. Acta* 93 (2005), pp. 297–304.

Conference papers

Backman, U., Lipponen, M., Auvinen, A., Tapper, U., Zilliacus, R. & Jokiniemi, J. Ruthenium behaviour in high temperature oxidising conditions. In: *Proceedings of European Aerosol Conference 2005*, 28.8–2.9.2005, Ghent, Belgium. P. 251.

Auvinen, A., Jokiniemi, J. & Roine, J. Facility for fine particle resuspension measurements. In *Proceedings of European Aerosol Conference 2005*, 28.8–2.9.2005, Ghent, Belgium. P. 301.

Auvinen, A., Backman, U., Jokiniemi, J., Kissane, M., Kunstár, M., Lipponen, M., Nagy, I., Vér, N. & Zilliacus, R. Investigation on Ruthenium Transport in Highly Oxidising Conditions. In: *Proceedings of Nuclear Energy for New Europe 2005*, 5.–8.9.2005, Bled, Slovenia, 2005. 11 p.

Auvinen, A., Davidovich, N., Ducros, G., Dutheillet, Y., Kissane, M., Matus, J. & Rizoiu, A. Ongoing investigations of ruthenium release and transport. In: *Proceedings of European Review Meeting on Severe Accident Research*, 14.–16.11.2005, Aix-en-Provence, France. 12 p.

Backman, U., Lipponen, M., Auvinen, A., Renvall, T., Tapper, U., Zilliacus, R. & Jokiniemi, J. Ruthenium behaviour in severe accident condition. In: Rätty, H. & Puska, E. K. (eds.). *SAFIR, The Finnish Research Programme on Nuclear Power Plant Safety 2003–2006, Interim Report*, VTT Research Notes 2272. VTT Processes. Espoo (2004). Pp. 175–182. ISBN 951-38-6515-0; ISSN 1235-0605.
<http://virtual.vtt.fi/inf/pdf/tiedotteet/2004/T2272.pdf>.

Kärkelä, T., Backman, U., Auvinen, A., Zilliacus, R., Lipponen, M., Kekki, T., Tapper, U. & Jokiniemi, J. Experiments on the behaviour of ruthenium in air ingress accidents, *Nordic Nuclear Safety Research Status seminar*, 28.–31.8.2005, Rättvik, Sweden.

Kärkelä, T., Backman, U., Auvinen, A., Zilliacus, R., Lipponen, M., Kekki, T., Tapper, U. & Jokiniemi, J. Transport av ruthenium-oxider. In: *Nordic Nuclear Safety Research Status seminar*, 10–11.5.2006, Espoo, Finland.

Kärkelä, T., Backman, U., Auvinen, A., Zilliacus, R., Lipponen, M., Kekki, T., Tapper, U. & Jokiniemi, J. Transport of ruthenium in diverse oxidising conditions. In: *Proceedings of International Aerosol Conference 2006*, 10–15.9.2006, St. Paul, USA.

Auvinen, A., Kärkelä, T., Jokiniemi, J. & Roine, J. Measurement and Modeling of Fine Particle Resuspension in Turbulent Tube Flow. In: Proceedings of International Aerosol Conference 2006, 10–15.9.2006, St. Paul, USA.

Kärkelä, T., Backman, U., Auvinen, A., Zilliacus, R., Lipponen, M., Kekki, T., Tapper, U. & Jokiniemi, J. Transport of ruthenium in diverse oxidising conditions. In: Proceedings of Nordic Society for Aerosol Research Aerosol symposium 2006, 9–10.11.2006, Helsinki, Finland.

Kärkelä, T., Backman, U., Auvinen, A., Zilliacus, R., Lipponen, M., Kekki, T., Tapper, U. & Jokiniemi, J. Transport of ruthenium in diverse oxidising conditions. Nordic Nuclear Safety Research YoungRad seminar 2006, 14–15.12.2006, Helsinki, Finland. (Accepted)

Kärkelä, T., Backman, U., Auvinen, A., Zilliacus, R., Lipponen, M., Kekki, T., Tapper, U. & Jokiniemi, J. Experiments on the behaviour of ruthenium in air ingress accidents. International Congress on Advances in Nuclear Power Plants 2007, 13–18.5.2007, Nice, France. (Submitted)

Kärkelä, T., Backman, U., Auvinen, A., Zilliacus, R., Lipponen, M., Kekki, T., Tapper, U. & Jokiniemi, J. Progress on ruthenium release and transport under air ingress conditions. European Review Meeting on Severe Accident Research 2007, 12–14.6.2007, Karlsruhe, Germany. (Accepted)

Research institute reports

Kärkelä, T., Backman, U., Auvinen, A., Zilliacus, R., Lipponen, M., Tapper, U. & Jokiniemi, J. Experiments on the behaviour of ruthenium in air ingress accidents – Progress report, VTT Processes, Project report PRO3/P3034/05, 9.9.2005. 8 p.

Auvinen, A., Jokiniemi, J., Lyyränen, J., Pyykönen, J. & Vääntinen, S. CHIP-facility sampling and quenching system, VTT Processes, Project report PRO3/P3048/05, 12.12.2005. 38 p. + app. 11 p.

Kärkelä, T., Backman, U., Auvinen, A., Zilliacus, R., Lipponen, M., Kekki, T., Tapper, U. & Jokiniemi, J. Experiments on the behaviour of ruthenium in air ingress accidents – Progress report year 2005, VTT Processes, Project report PRO3/P3054/05, 23.12.2005. 12 p.

Kärkelä, T., Backman, U., Auvinen, A., Zilliacus, R., Lipponen, M., Kekki, T., Tapper, U. & Jokiniemi, J. Experiments on the behaviour of ruthenium in air ingress accidents – Progress report June 2006, VTT Project report VTT-R-06200-06, 24.06.2006. 13 p.

Development of Aerosol Models to Nuclear Applications (AMY, 2003–2004):

Conference papers

Auvinen, A. & Jokiniemi, J. K. Modelling resuspension of particle layer in an internal tube flow. Presented in the European Aerosol Conference (EAC04), September 6–10, 2004, Budapest, Hungary.

Routamo, T., Jokiniemi, J. & Mäkynen, J. Aerosol Deposition in Horizontal Steam Generator Tubes in Severe Accident Conditions. Presented in the Tenth International Topical Meeting on Nuclear Reactor Thermal Hydraulics (NURETH-10), October 5–9, 2003, Seoul, Korea.

Research institute reports

Auvinen, A. & Jokiniemi, J. Aerosolimallien kehittäminen ydinvoimalaitossovelluksiin – Hiukkasdeposition käyttäytyminen turbulentissa virtauksessa. VTT Prosessit, Espoo 17.12.2003. Projektiraportti PRO3/P71/03. (In Finnish).

Hokkinen, J. Deposition experiments with CsI and CsOH. VTT Processes, Espoo, September 26, 2003. Research report no. PRO3/P56/03.

Karttunen, V. APROS SA fission product validation in containment nodes with CsOH, Fortum Nuclear Services Ltd, Report 24.1.2005, TERMO-435.

Mäkynen, J., Jokiniemi, J. & Routamo, T. HORIZON 1 tube experiment with CsOH and CsI as aerosol material. VTT Processes, Espoo 8.5.2003. Research report no. PRO3/895/03.

Mäkynen, J., Jokiniemi, J. & Routamo, T. HORIZON 1 tube experiment with varying flow rate. VTT Processes, Espoo 18.8.2003. Research report no. PRO3/1073/03.

Routamo, T. Aerosol model development for nuclear applications. In: Rätty, H. & Puska, E. K. (eds.). SAFIR, The Finnish Research Programme on Nuclear Power Plant Safety 2003–2006, Interim Report, VTT Research Notes 2272. VTT Processes, Espoo (2004). Pp. 183–191. ISBN 951-38-6515-0; ISSN 1235-0605. <http://virtual.vtt.fi/inf/pdf/tiedotteet/2004/T2272.pdf>.

Others

Siltanen, S. Influence of Uncertainty of Calculation Parameters in Modelling on Radioactive Releases in Severe Accident Conditions. Helsinki University of Technology, Master's Thesis, 2 December 2003. 93 p. + app. (In Finnish).

Routamo, T. & Jokiniemi, J. Aerosol model development for nuclear power plant applications – AMY. In: FINE-ohjelmakatsaus. Pekka Järvinen (ed.). Teknologiakatsaus 160/2004. (In Finnish).

Karttunen, V. Validation of a fission product revaporization model, Master's Thesis, Helsinki University of Technology, Espoo, January 10, 2005.

Emergency preparedness supporting studies (OTUS, 2003):

Research institute reports

Rossi, J. Maa- ja merituuli ydinvoimalaitoksen onnettomuustilanteessa. Espoo: VTT Prosessit Projektiraportti PRO1/P7021/03. 17 p.

Rossi, J. OTUS summary report. In: Rätty, H. & Puska, E. K. (eds.). SAFIR, The Finnish Research Programme on Nuclear Power Plant Safety 2003–2006, Interim Report, VTT Research Notes 2272. VTT Processes. Espoo (2004). Pp. 192–193. ISBN 951-38-6515-0; ISSN 1235-0605.
<http://virtual.vtt.fi/inf/pdf/tiedotteet/2004/T2272.pdf>.

Rossi, J. Säteilystasolaskelmia suojarakennuksen ohittavassa onnettomuudessa huoltoseisokin aikana Olkiluodon voimalaitoksella. Espoo: VTT Prosessit Projektiraportti PRO1/P7022/03. 14 p.

Interaction approach to development of control rooms (IDEC):

Scientific publications

Norros, L. 2004. Acting under uncertainty. Core-task analysis in ecological study of work. VTT Publications 546, Espoo. 241 p. ISBN 951-38-6410-3; 951-38-6411-1244.
<http://virtual.vtt.fi/inf/pdf/publications/2004/P546.pdf>.

Norros, L. & Nuutinen, M. 2005. Performance-based usability evaluation of safety information and alarm system. *International Journal of Human-computer studies*, 63 (205), pp. 328–361.

Norros, L. & Savioja, P. 2004. Ihminen-tekniikka -vuorovaikutuksen toimivuuden arviointi monimutkaisissa tietointensiivisissä töissä. *Työ ja Ihminen*, 3, pp. 100–112.

Savioja, P. & Norros, L. Systems Usability – promoting core-task oriented work practices. In: Law, E., Thora Hvannberg, E., Cocton, G. & Vanderdonck, J. *Maturing Usability: Quality in software, Interaction and Value*. Springer.

Norros, L. (2005) The concept of habit in an activity-theoretical analysis of situated actions. *Theoretical Issues in Ergonomics Science*, Vol. 6, 5, pp. 385–408.

Conference papers

Norros, L. 2003. Understanding use in the design of smart tools –reflections on the conception of collaborative design. Invited paper at Smart Objects Conference, May 15–17, Grenoble France 21–26.

Norros, L. 2003. How does the human actor collect and process information? Abstracts from the 27th Congress of the Scandinavian Society of Anaesthesiology, and Intensive Care Medicine. *Acta Anaesthesiologica Scandinavica*, 47, 116, pp. 84–86.

Norros, L., Nuutinen, M & Savioja, P. Development of indicators for integrated system validation. In: Rätty, H. & Puska, E. K. (eds.). *SAFIR, The Finnish Research Programme on Nuclear Power Plant Safety 2003–2006, Interim Report, VTT Research Notes 2272*. VTT Processes. Espoo (2004). Pp. 215–223. ISBN 951-38-6515-0; ISSN 1235-0605. <http://virtual.vtt.fi/inf/pdf/tiedotteet/2004/T2272.pdf>.

Norros, L. & Savioja, P. 2003. Design and usage: Sharing a common motive. Paper presented at Workshop 9: The problem of user-design relations in technology production. At the 8th European Conference on Computer-supported Cooperative Work, 14–18 September, Helsinki.

Norros, L. & Savioja, P. 2004. Modelling of the activity system – development of an evaluation method for integrated system validation. Presented at Enlarged Halden Programme Group Meeting, Sandefjord, C2.9.1–12.

Norros, L. & Savioja, P. 2005. Theoretical justification of performance indicators for integrated validation of complex systems. *Proceedings of the EHPG meeting in Lillehammer, Oct 17–21, 2005*.

Savioja, P. & Norros, L. 2004. Developing the concept of system usability. Presented at IFAC/IFIP/IFORS/IEA Symposium Analysis, design, and evaluation of human-machine systems, Atlanta, GA.

Savioja, P. & Norros, L. 2004. Evaluation of operator practices as means of integrated system validation. Presented at Forth American Nuclear Society International Topical Meeting on Nuclear Plant Instrumentation, Controls and Human-machine Interface Technologies, Columbus, Ohio.

Laarni, J. Norros, L. & Rinttilä, E. (2006) Control room modernization from an evolutionary point of view – experiences gained at Loviisa NPP. Joint HRP and CSNI SEGHOFF Workshop on Future Control Station Designs and Human Performance ISSUES in Nuclear Power Plants. May 8–10, Halden Pre-proceedings, 6.2. 13 p.

Norros, L. & Savioja, P. Towards a theory and method for usability evaluation of complex human-technology systems. In: 16th World Congress of International Ergonomic Association. 2006. Maastricht, The Netherlands.

Salo, L., Laarni, J. & Savioja, P. Operator experiences on working in screen-based control rooms. In: The 5th ANS International Topical Meeting on Nuclear Plant Instrumentation, Controls, and Human Machine Interface Technology, Albuquerque Nov 12–16, 2006. [CD-ROM] La Grange Park: American Nuclear Society, 2006. Pp. 451–458. ISBN 0-89448-051-0.

Laarni, J. & Norros, L. Control room modernization at Finnish Nuclear power plants – two projects compared. In: The 5th ANS International Topical Meeting on Nuclear Plant Instrumentation, Controls, and Human Machine Interface Technology, Albuquerque Nov 12–16, 2006. [CD-ROM] La Grange Park: American Nuclear Society, 2006. Pp. 890–897. ISBN 0-89448-051-0.

Norros, L. & Savioja, P. Is function-based control room design human-centered? In: The 5th ANS International Topical Meeting on Nuclear Plant Instrumentation, Controls, and Human Machine Interface Technology, Albuquerque Nov 12–16, 2006. [CD-ROM] La Grange Park: American Nuclear Society, 2006. Pp. 717–722. ISBN 0-89448-051-0.

Salo, L. & Savioja, P. 2006. Practices of process control in digital control rooms: possibilities and threats. 13th European Conference on Cognitive Ergonomics, Zürich September 20–22. Pp. 121–122.

Research institute reports

Savioja, P. 2003. Käyttäjakeskeiset menetelmät monimutkaisten järjestelmien vaatimusten kuvaamisessa. Espoo: VTT Tiedotteita 2216. 132 p. + app. 10 s. ISBN 951-38-6186-4; 951-38-6187-2.
<http://virtual.vtt.fi/inf/pdf/tiedotteet/2003/T2216.pdf>.

Norros, L. & Savioja, P. 2004. Usability evaluation of complex systems Report STUK-YTO-TR 204, Radiation and Nuclear Safety Authority (STUK), Helsinki, Finland. 47 p. (also: Report BTUO64-031188, VTT Industrial Systems, Technical Research Centre of Finland, Espoo.) 47 p.

Savioja, P. & Norros, L. 2003. Artefact performance evaluation – Preliminary framework. Report BTUO62-041223, VTT industrial Systems, Technical Research Centre of Finland, Espoo.

Savioja, P. & Norros, L. 2005. Performance based human factors evaluation of complex systems. Research report, No. BTU062-041311.

Savioja, P., Norros, L., Laarni, J. & Salo, L. 2006. Analysis of simulator runs using CASU framework. Research report, No. VTT-R-00833-6. 44 p. + app.

Savioja, P. & Norros, L. 2005. Integrated validation of complex systems. In: Nuutinen, M. & Luoma, J. (eds.). Human practice in the life cycle of complex systems – Challenges and methods. Espoo: VTT Publications 582. Pp. 54–63. ISBN 951-38-6675-0; 951-38-6676-9.
<http://virtual.vtt.fi/inf/pdf/publications/2005/P582.pdf>.

Laarni, J. & Norros, L. (2006) Modernization of NPP control room: evaluation of the design process of Loviisa case. VTT internal report.

Others

Norros, L. 2005. Systems Usability: A concept to support the design of smart objects and environments. HOT Topics article, October. Carlton University, Human Oriented Technology Lab, Canada.
<http://www.carleton.ca/hotlab/hottopics/Articles/October2005-SystemsUsabil.html>;
<http://www.carleton.ca/hotlab/hottopics/Articles/October2005-SystemsUsabil.html>.

Papers and reports under review or in press

Norros, L. & Savioja, P. Validation of NPP's modernised control rooms: what is to be expected from new human factor assessment methods? Eurosafte Forum. (In Press).

Savioja, P. & Norros, L. Systems Usability – promoting core-task oriented work practices. In: Law, E., Thora Hvannberg, E., Cocton, G. & Vanderdonckt, J. Maturing Usability: Quality in software, Interaction and Value. Springer. (In Press).

Application Possibilities of Systematic Requirements Management in the Improvement of Nuclear Safety in Finland (APSREM, 2003):

Research institute reports

Renlund, M. & Taskinen, V. Vaatimushallinnan soveltamismahdollisuudet ydinturvallisuuden parantamisessa Suomessa. Helsinki: Säteilyturvakeskus (STUK), 2004. 54 p. (STUK-YTO-TR 203).

Taskinen, V. APSREM summary report In: Rätty, H. & Puska, E. K. (eds.). SAFIR, The Finnish Research Programme on Nuclear Power Plant Safety 2003–2006, Interim Report, VTT Research Notes 2272. VTT Processes. Espoo (2004). Pp. 224–225. ISBN 951-38-6515-0; ISSN 1235-0605.
<http://virtual.vtt.fi/inf/pdf/tiedotteet/2004/T2272.pdf>.

Influence of RoHS -directive to reliability of electronics, Prestudy (ROVEL, 2004):

Research institute reports

Palmén, H. & Turtola, A. RoHS-direktiivin vaikutus elektroniikan luotettavuuteen. Tutkimusraportti TUO26-055317, VTT Tuotteet ja tuotanto.

Hossi, H., Palmén, H. & Turtola, A. ROVEL summary report. In: Rätty, H. & Puska, E. K. (eds.). SAFIR, The Finnish Research Programme on Nuclear Power Plant Safety 2003–2006, Interim Report, VTT Research Notes 2272. VTT Processes. Espoo (2004). Pp. 226–227. ISBN 951-38-6515-0; ISSN 1235-0605. <http://virtual.vtt.fi/inf/pdf/tiedotteet/2004/T2272.pdf>.

Software qualification – error types and error management in software life-cycle (QETES, 2005–2006):

Research institute reports

Harju, H., Ranta, J. & Välisuo, M. Software qualification, Working report, part 1: New fault types in software life-cycle. VTT-R-11706-06. Espoo 2006. 66 p.

Harju, H. & Välisuo, M. Software qualification, Working report, part 2: Error management methods for new fault types. VTT-R-11707-06. Espoo 2006. 48 p.

Others

Harju, H., Ranta, J. & Välisuo, M. Computer semiotic faults. Espoo 2006. VTT Working papers.

Influence of Whiskers to Reliability of Electronics, Prestudy (WHISKE, 2005):

Conference papers

Ageing performance of electromagnetic relays – evaluation based on a five year in-service study and a life test. Helge Palmén, VTT Industrial Systems. International Workshop on “Practical Applications of Age-Dependent Reliability Models and Analysis of Operational Data”, 5–6 October 2005, Fontenay aux Roses, France.

Summary and conclusions of the International Workshop on "Practical Applications of Age-Dependent Reliability Models and Analysis of Operational Data", 5–6 October 2005, Fontenay aux Roses, France.

Research institute reports

Palmén, H., Turtola, A. & Hossi, H. Influence of Whiskers to Reliability of Electronics. VTT research report, NRO VTT-R-00856-06, Espoo, 31.1.2006. 15 p. (In Finnish).

Others

IEC 62342 Ed. 1.0 B CCDV Nuclear power plants – Instrumentation and control important to safety – Management of aging.

PNW 45A-597 Ed. 1.0 E PNW Methods for nuclear power plants – I&C systems important to safety – Management of aging of electrical cable systems.

Organisational culture and management of change (CULMA):

Scientific publications

Kettunen, J., Reiman, T. & Wahlström, B. (2006). Analysis of Challenges to Nuclear Power Plant Safety Management: Finland, Sweden, and the European Context. In: Svenson, O., Salo, I., Skjerve, A. B., Reiman, T. & Oedewald, P. (eds.). *Nordic perspectives on safety management in high reliability organizations: Theory and applications*. Valdemarsvik: Akademitryck.

Oedewald, P. & Reiman, T. (2003). Core Task Modelling in Cultural Assessment – A Case Study in Nuclear Power Plant Maintenance. *Cognition, Technology & Work* 5, pp. 283–293.

Reiman, T. & Oedewald, P. (2004). Measuring maintenance culture and maintenance core task with CULTURE-questionnaire – a case study in the power industry. *Safety Science* 42 (9), pp. 859–889.

Reiman, T. & Oedewald, P. (2006). Organizational culture and social construction of safety in industrial organizations. In: Svenson, O., Salo, I., Skjerve, A. B., Reiman, T. & Oedewald, P. (eds.). *Nordic perspectives on safety management in high reliability organizations: Theory and applications*. Pp. 115–129. Valdemarsvik: Akademitryck.

Reiman, T., Oedewald, P. & Rollenhagen, C. (2005). Characteristics of organizational culture at the maintenance units of two Nordic nuclear power plants. *Reliability Engineering and System Safety* 89 (3), pp. 333–347.

Reiman, T. & Oedewald, P. (2006). Assessing the maintenance unit of a nuclear power plant – identifying the cultural conceptions concerning the maintenance work and the maintenance organization. *Safety Science* 44 (9), pp. 821–850.

Conference papers

Kettunen, J., Jones, B. & Reiman, T. (2004). Assessing Challenges to Nuclear Power Plant Management in Five European Countries: Methods, Results and Lessons Learned. In: Spitzer, C., Schmocher, U., Dang, V. N. (eds.). *Probabilistic Safety Assessment and Management. PSAM7 – ESREL'04. Volume 3*. Springer, London.

Kettunen, J., Mikkola, M. & Reiman, T. (2004). When Availability Counts – Key Concepts, Constraints and Challenges of Outsourcing in the Nuclear Power Industry. *The 9th International Symposium on Logistics. Logistics and Global Outsourcing. Bangalore, India. 11–14 July 2004*.

Oedewald, P. & Reiman, T. (2003). New Demands and Old Conceptions. Assessing and Redesigning Practices in a Stable Industry. A poster presentation at 11th EAWOP Congress in Portugal, Lisbon, May 2003.

Oedewald, P. & Reiman, T. (2005). Enhancing maintenance personnel's job motivation and organizational effectiveness. *CSNI workshop on Better Nuclear Plant Maintenance: Improving Human and Organisational Performance. Ottawa, Canada. 3–5 October 2005*.

Oedewald, P. & Reiman, T. (2006). Using subjective measures to monitor the systems' capability to manage complexity – evidence from the nuclear industry and health care. In: Hollnagel, E. & Rigaud, E. (eds.), *Proceedings of the Second Resilience Engineering Symposium. 8–10 November, 2006. Antibes, Juan-Les-Pins, France*.

Reiman, T. & Oedewald, P. (2003). Influence of the conceptions of the organisation's core task on job satisfaction and perceived workplace values – a case study in nuclear power plant maintenance. Presentation at 11th EAWOP Congress in Portugal, Lisbon, May 2003.

Reiman, T. & Oedewald, P. Organisational challenges of maintenance work at NPPs. In: Rätty, H. & Puska, E. K. (eds.). SAFIR, The Finnish Research Programme on Nuclear Power Plant Safety 2003–2006, Interim Report, VTT Research Notes 2272. VTT Processes. Espoo (2004). Pp. 235–242. ISBN 951-38-6515-0; ISSN 1235-0605. <http://virtual.vtt.fi/inf/pdf/tiedotteet/2004/T2272.pdf>.

Reiman, T. & Oedewald, P. (2005). Exploring the effect of organizational changes on the safety and reliability of maintenance. CSNI workshop on Better Nuclear Plant Maintenance: Improving Human and Organisational Performance. Ottawa, Canada. 3–5 October 2005.

Reiman, T. & Oedewald, P. (2006). Contextual Assessment of Organizational Culture in Complex Sociotechnical Systems. In: Proceedings of the Ninth International Symposium of the ISSA Research Section, 1–3 March 2006, Nice, France.

Reiman, T., Oedewald, P. & Kettunen, J. CULMA summary report. In: Rätty, H. & Puska, E. K. (eds.). SAFIR, The Finnish Research Programme on Nuclear Power Plant Safety 2003–2006, Interim Report, VTT Research Notes 2272. VTT Processes. Espoo (2004). Pp. 228–234. ISBN 951-38-6515-0; ISSN 1235-0605. <http://virtual.vtt.fi/inf/pdf/tiedotteet/2004/T2272.pdf>.

Reiman, T., Oedewald, P. & Rollenhagen, C. (2004). Comparison of organisational cultures at two NPP maintenance units. When is maintenance work motivating and meaningful? In: Spitzer, C., Schmocher, U. & Dang, V. N. (eds.). Probabilistic Safety Assessment and Management. PSAM7 – ESREL '04. Volume 2. Springer, London.

Research institute reports

Nuutinen, M. & Reiman, T. (2005). Management of operators' competence and change of generation at a nuclear power plant. In: Nuutinen, M. & Luoma, J. (eds.). Human Practice in the Life-cycle of Complex Systems. Challenges and Methods. VTT Publications 582. Pp. 115–121. ISBN 951-38-6675-0; 951-38-6676-9. <http://virtual.vtt.fi/inf/pdf/publications/2005/P582.pdf>.

Kettunen, J. & Reiman, T. (2004). Ulkoistaminen ja alihankkijoiden käyttö ydinvoimateollisuudessa. VTT Tiedotteita 2228. 66 p. + app. 2 p. ISBN 951-38-6206-2; 951-38-6207-0. <http://virtual.vtt.fi/inf/pdf/tiedotteet/2004/T2228.pdf>.

Oedewald, P. & Reiman, T. (2006). Turvallisuuskriittisten organisaatioiden toiminnan erityispiirteet. VTT Publications 593. VTT, Espoo. 108 p. + app. 10 p. ISBN 951-38-6698-X; 951-38-6699-8. <http://virtual.vtt.fi/inf/pdf/publications/2006/P593.pdf>.

Reiman, T. & Oedewald, P. (2004). Kunnossapidon organisaatiokulttuuri. Tapaustutkimus Olkiluodon ydinvoimalaitoksessa. VTT Publications 527. Espoo: VTT. 63 p. + app. 8 p. ISBN 951-38-6371-9; 951-38-6372-7. <http://virtual.vtt.fi/inf/pdf/publications/2004/P527.pdf>.

Reiman, T. & Oedewald, P. (2005). Cultural approach to organisations and management of change. In: Nuutinen, M. & Luoma, J. (eds.). Human Practice in the Life-cycle of Complex Systems. Challenges and Methods. VTT Publications 582. Pp. 122–130. ISBN 951-38-6675-0; 951-38-6676-9. <http://virtual.vtt.fi/inf/pdf/publications/2005/P582.pdf>.

Nuutinen, M., Reiman, T. & Oedewald, P. (2003). Osaamisen hallinta ydinvoimalaitoksessa operaattoreiden sukupolvenvaihdostilanteessa. VTT Publications 496. Espoo: VTT. 82 p. ISBN 951-38-6046-9; 951-38-6047-7. <http://virtual.vtt.fi/inf/pdf/publications/2003/P496.pdf>.

Wahlström, B., Kettunen, J., Reiman, T., Wilpert, B., Maimer, H., Jung, J., Cox, S., Jones, B., Sola, R., Prieto, J. M., Arias, R. M. & Rollenhagen, C. (2005). LearnSafe. Learning organisations for nuclear safety. VTT Research Notes 2287. VTT: Espoo. 58 p. + app. 7 p. ISBN 951-38-6538-X; 951-38-6539-8. <http://virtual.vtt.fi/inf/pdf/tiedotteet/2005/T2287.pdf>.

Others

Oedewald, P. (2004). Henkilöjohtamisen haasteet kunnossapidossa – jatkuvan innostuksen ja mielenkiinnon ylläpito ja kehittäminen. Kunnossapitoyhdistys. Kunnossapitopäivät 2004, Helsinki 24.–25.11.

Oedewald, P. & Reiman, T. (2005). Henkilöjohtamisen haasteet kunnossapidossa. Mielenkiinnon ja innostuksen ylläpitäminen muutoksissa. Kunnossapitolehti, 1, pp. 43–45.

Reiman, T. & Oedewald, P. (2004). Safety Culture. In: Holmberg, K. et al. Safety and Reliability. Technology Review. Research Report BTUO43-031209.

Reiman, T. & Oedewald, P. (2005). TVO:n uusien kunnossapitäjien koulutus ja perehdytys. ATS Ydintekniikka 34 (1), pp. 18–19.

Reiman, T., Oedewald, P., Kettunen, J., Rollenhagen, C. & Kahlbom, U. (2005). Maintenance culture and management of change (NKS/MainCulture). Intermediate report 2004. NKS-108. Nordic nuclear safety research, Roskilde.

Reiman, T., Oedewald, P., Rollenhagen, C. & Eriksson, I. (2004). Contextual assessment of maintenance culture at Olkiluoto and Forsmark. NKS-94. Nordic nuclear safety research, Roskilde. http://130.226.56.167/nordisk/publikationer/1994_2004/NKS-94.pdf.

Reiman, T., Oedewald, P., Rollenhagen, C. & Kahlbom, U. (2006). Management of change in the nuclear industry. Evidence from maintenance reorganizations. MainCulture Final Report. NKS-119. Nordic nuclear safety research, Roskilde.

Reiman, T. & Oedewald, P. (2003). Kunnossapitokulttuurin arvioiminen TVO:lla. Luottamuksellinen tutkimusraportti TUO64-033187.

Reiman, T. & Oedewald, P. (2003). Kunnossapitokulttuurin arvioiminen TVO:lla. CAOC-metodologiaan perustuva tapaustutkimus Olkiluodon ydinvoimalaitoksen kunnossapito-organisaatiossa. Julkinen tutkimusraportti BTUO64-031176.

Papers and reports under review or in press

Reiman, T. & Oedewald, P. Assessment of Complex Sociotechnical Systems – Theoretical issues concerning the use of organizational culture and organizational core task concepts. Safety Science. (In press).

Reiman, T. Assessing organizational culture in complex sociotechnical systems – Methodological evidence from studies in nuclear power plant maintenance organizations. Academic dissertation. (Inreview).

Reiman, T. & Oedewald, P. Culma summary report. In: Rätty, H. & Puska, E. K. (eds.). SAFIR, The Finnish Research Programme on Nuclear Power Plant Safety 2003–2006, Final Report, VTT Research Notes. VTT. Espoo (2006). (In press).

Reiman, T. & Oedewald, P. Organizational factors, management, and nuclear safety. In: Rätty, H. & Puska, E. K. (eds.). SAFIR, The Finnish Research Programme on Nuclear Power Plant Safety 2003–2006, Final Report, VTT Research Notes. VTT. Espoo (2006). (In press).

Disseminating Tacit Knowledge in Organizations (TIMANTTI):

Scientific publications

Kuronen, T. & Rintala, N. (2005). The Classification of Knowledge and Expertise in Finnish Nuclear Power Plants. *International Journal of Nuclear Knowledge Management*, 2006, 2 (2).

Rintala, N. & Kuronen, T. (2005). How to Share Tacit Nuclear Knowledge. *International Journal of Nuclear Knowledge Management*, 2006, 2 (2).

Rintala, N. & Hyttinen, L. (2004) Methods for Sharing Tacit Nuclear Knowledge and Expertise. *International Journal of Nuclear Knowledge Management*, 2006, 2 (1).

Hyttinen, L. & Rintala, N. (2004) The Role of Tacit Knowledge and the Challenges in Transferring it – A Case Study in The Finnish NPP's. *International Journal of Nuclear Knowledge Management*, 2005, 1 (4).

Conference papers

Kuronen, T. (2006) Preserving expertise and tacit knowledge in NPP. In: *The Proceedings of the 7th International CINet Conference*, 8–12 September, Lucca, Italy.

Kuronen, T. & Rintala, N. (2005). What is Tacit Knowledge in NPP Maintenance? In: *The Proceedings of CSNI Workshop on Better Nuclear Plant Maintenance: Improving Human and Organisational Performance*, 3–5 October, Ottawa, Canada.

Kuronen, T. & Rintala, N. (2005). The Prerequisites for Successful Knowledge Sharing in Nuclear Power Plants. In: *The Proceedings of CSNI Workshop on Better Nuclear Plant Maintenance: Improving Human and Organisational Performance*, 3–5 October, Ottawa, Canada.

Hyttinen, L. & Rintala, N. (2004) The Role of Tacit Knowledge and the Challenges in Transferring it in the Nuclear Power Plant Context. *IAEA Conference 'Managing Nuclear Knowledge'*, September, 6–8, Saclay, France.

Hyttinen, L. & Rintala, N. (2004). Enhancing the Transfer of Non-Articulated Expert Knowledge at the Finnish NPPs – A Project Proposal Based on a Pre-Study Conducted at the Finnish NPPs. *NKS Workshop on Knowledge Management in the Nordic NPPs*, October, 7–8, Halden, Norway.

Rintala, N. & Hyttinen, L. (2004) Methods for Sharing Tacit Nuclear Knowledge and Expertise. In: *The Proceedings of the IAEA Conference 'Managing Nuclear Knowledge'*, September, 6–8, Saclay, France.

Rintala, N. & Hyttinen, L. The role of tacit knowledge and the challenges and methods in sharing it at the Finnish NPPs. In: Rätty, H. & Puska, E. K. (eds.). *SAFIR, The Finnish Research Programme on Nuclear Power Plant Safety 2003–2006, Interim Report, VTT Research Notes 2272*. VTT Processes. Espoo (2004). Pp. 243–250. ISBN 951-38-6515-0; ISSN 1235-0605. <http://virtual.vtt.fi/inf/pdf/tiedotteet/2004/T2272.pdf>.

Others

Kuronen, T. & Tikka, T. (2005) Kokemuseräisen osaamisen jakaminen Olkiluodon voimalaitoksen voimalaitostekniikan yksikössä. *Luottamuksellinen tutkimusraportti*.

Kuronen, T. & Tikka, T. (2005) Kokemuseräisen osaamisen jakaminen mekaanisen kunnossapidon työnopastuksessa. *Luottamuksellinen tutkimusraportti*.

Papers under review or in press

Säämänen, K. & Kuronen, T. (2006) Hiljaisen tiedon jakamisen tukeminen operaattorikoulutuksen valvomoharjoittelussa. Luottamuksellinen tutkimusraportti.

Kuronen, T., Järvenpää, E. & Säämänen, K. (2006). (In preparation) Hiljaisen tiedon säilyttäminen ydinvoimalaitoksissa.

Kuronen, T. & Säämänen, K. (2006) (In preparation) Tacit Knowledge in NPP Operators, Maintenance and Technical Designers – A Comparative Case Study.

Potential of fire spread (POTFIS):

Scientific publications

Mangs, J., Paananen, J. & Keski-Rahkonen, O. Calorimetric fire experiments on electronic cabinets, *Fire Safety Journal* 38 (2003), pp. 165–186.

Hostikka, S. & Keski-Rahkonen, O. Probabilistic simulation of fire scenarios, *Nuclear Engineering and Design*, Vol. 224 (2003), No: 3, pp. 301–311.

Floyd, J. E., McGrattan, K. B., Hostikka, S. & Baum, H. R. CFD Fire Simulation Using Mixture Fraction Combustion and Finite Volume Radiative Heat Transfer, *Journal of Fire Protection Engineering*, 13, (2003), pp. 11–36.

Mangs, J. 2004. On the fire dynamics of vehicles and electrical equipment. VTT Publications 521, VTT Building and Transport, Espoo. 62 p. + app. 101 p. (Dissertation). ISBN 951-38-6273-9; 951-38-6274-7. <http://virtual.vtt.fi/inf/pdf/publications/2004/P521.pdf>.

Hostikka, S., Korhonen, T. & Keski-Rahkonen, O. Two-Model Monte Carlo Simulation of Fire Scenarios. In: Gottuk, D. & Lattimer, B. (eds.). *Proceedings of the 8th International Symposium on Fire Safety Science*, 18–23 September, 2005, Beijing, China. Pp. 1241–1253.

Korhonen, T., Hostikka, S. & Keski-Rahkonen, O. A proposal for the goals and new techniques of modelling pedestrian evacuation in fires. In: Gottuk, D. & Lattimer, B. (eds.). *Proceedings of the 8th International Symposium on Fire Safety Science*, 18–23 September, 2005, Beijing, China. Pp. 557–569.

Hostikka, S. & McGrattan, K. Numerical modeling of radiative heat transfer in water sprays. *Fire Safety Journal*, Vol. 41, (2006) No. 1, pp. 76–86.

Conference papers

Keski-Rahkonen, O. & Korhonen, T. Horizontal vent algorithms in zone model simulations, 7th International Collaborative Project to Evaluate Fire Models for Nuclear Power Plant Applications, Worcester Polytechnic Institute, Worcester, MA, USA, July 30 – August 1, 2003. 21 slides.

Mangs, J. & Keski-Rahkonen, O. Failure distribution in instrumental cables in fire. *Transactions of the SMiRT 17, 17th International Conference on Structural Mechanics in Reactor Technology*, Prague, Czech Republic, August 17–22, 2003, International Association for Structural Mechanics in Reactor Technology, Paper # O04-4. 8 p.

Keski-Rahkonen, O. Effect of electrical conductivity on emergency performance of cables at high temperatures. *Transactions of the SMiRT 17, 17th International Conference on Structural Mechanics in Reactor Technology*, Prague, Czech Republic, August 17–22, 2003, International Association for Structural Mechanics in Reactor Technology, Paper # J07-5. 8 p.

Hostikka, S., Keski-Rahkonen, O. & Korhonen, T. Use of numerical simulations for fire PSA, *Proceedings of the SMiRT 17 Post Conference Seminar Nr. 21 on Fire Safety in Nuclear Power Plants and Installations*, 8th International SMiRT Post Conference Seminar, August 25–28, 2003, NPP Jaslovské Bohunice, Slovak Republic. 37 p.

- Keski-Rahkonen, O. & Hostikka, S. Zone model validation of room fire scenarios, International Collaborative Project to Evaluate Fire Models for Nuclear Power Plant Applications: Summary of 5th Meeting, Gaithersburg, MA, May 2 and 3, 2002. NISTIR 6986. NIST. Gaithersburg, MD (2003). Pp. C-59–C-72.
- Keski-Rahkonen, O. A new model for time lag of smoke detectors, International Collaborative Project to Evaluate Fire Models for Nuclear Power Plant Applications: Summary of 5th Meeting, Gaithersburg, MA, May 2 and 3, 2002. NISTIR 6986. NIST. Gaithersburg, MD (2003). Pp. C-171–C-178.
- Keski-Rahkonen, O. Ideas on needs for fire tests, 4th Meeting of the International Collaborative Project to Evaluate Fire Models for Nuclear Power Plant Applications, GRS Berlin, October 17–18, 2001. GRS (2003). 22 p.
- Keski-Rahkonen, O. Nyysönen, T. & Rajakko, J. Exploration and analysis of fire detection and alarm system data from nuclear and non-nuclear installations in Finland, Fire & Safety, 5th International Conference. Munich, 11–12 March 2004, Conference Proceedings. Nuclear Engineering International, London (2004). 14 p.
- Keski-Rahkonen, O., Rönty, V. & Hassinen, J. P. Exploration and analysis of sprinkler data from nuclear and non-nuclear installations in Finland, Fire & Safety, 5th International Conference. Munich, 11–12 March 2004, Conference Proceedings. Nuclear Engineering International. London (2004). 14 p.
- Keski-Rahkonen, O. 2004. Model of time lag of smoke detectors. In: Luck, H., Laws, P. & Willms, I. (eds.). AUBE '04, 13. Internationale Konferenz über “Automatische Brandentdeckung”, 14.–16. September 2004, Universität Duisburg-Essen, Deutschland. Universität Duisburg-Essen. Duisburg (2004). P. 418.
- Keski-Rahkonen, O. Hostikka, S. & Mangs, J. Where are we today with fire modeling, and where do we go? 9th Meeting of the International Collaborative Fire Model Project (ICFMP), May 18–20, 2005, Huntersville, SC, USA. Duke Energy. Huntersville (2005). 20 p.
- Keski-Rahkonen, O., Mangs, J. & Hostikka, S. Possibility of fire spread on FRNC cables in NPPs. International Workshop on Fire Probabilistic Safety Assessment, Puerto Vallarta, Mexico, 23–26 May, 2005. NEA, CSNI, WGRISK. Puerto Vallarta (2005). 43 p.
- Hostikka, S., Korhonen, T. & Keski-Rahkonen, O. Application of TMMC to relay room fires in a NPP. International Workshop on Fire Probabilistic Safety Assessment, Puerto Vallarta, Mexico, 23–26 May, 2005. NEA, CSNI, WGRISK. Puerto Vallarta (2005). 44 p.
- Keski-Rahkonen, O. & Mangs, J. 2005. POTFIS project special report – Experiments and modelling on vertical flame spread. In: Rätty, H. & Puska, E. K. (ed.). 2004. SAFIR, The Finnish Research Programme on Nuclear Power Plant Safety 2003–2006, Interim Report, VTT Research Notes 2272. VTT Processes, Espoo. Pp. 257–265. ISBN 951-38-6515-0; ISSN 1235-0605. <http://virtual.vtt.fi/inf/pdf/tiedotteet/2004/T2272.pdf>.
- Keski-Rahkonen, O., Mangs, J., Hostikka, S. & Korhonen, T. 2005. POTFIS project summary report. In: Rätty, H. & Puska, E. K. (ed.). 2004. SAFIR, The Finnish Research Programme on Nuclear Power Plant Safety 2003–2006, Interim Report, VTT Research Notes 2272. VTT Processes, Espoo. P. 251–256. ISBN 951-38-6515-0; ISSN 1235-0605. <http://virtual.vtt.fi/inf/pdf/tiedotteet/2004/T2272.pdf>.
- Keski-Rahkonen, O. & Mangs, J. Assessing of flame spread on NPP cables. Y. Zhou, S. Yu & Y. Xu (eds.). Proceedings of the 18th International Conference on Structural Mechanics in Reactor Technology. SMiRT 18. Beijing, China, August 7–12, 2005. Atomic Energy Press. Beijing (2005). Pp. 3972–3983.

Hostikka, S. & Keski-Rahkonen, O. Advanced probabilistic simulation of NPP fires. In: Zhou, Y., Yu, S. & Xu, Y. (eds.). Proceedings of the 18th International Conference on Structural Mechanics in Reactor Technology. SMiRT 18. Beijing, China, August 7–12, 2005. Atomic Energy Press. Beijing (2005). Pp. 3984–3996.

Keski-Rahkonen, O., Mangs, J., Hostikka S. & Korhonen, T. Quantitative Assessment of Potential of Fire Spread in Nuclear Power Plant Scenarios. Post-Conference Seminar III of the 18th International Conference on Structural Mechanics In Reactor Technology (SMiRT 18). 9th International Seminar on Fire Safety In Nuclear Power Plants And Installations. August 22–24, 2005, Vienna. IAEA.

Keski-Rahkonen, O., Hostikka, S. & Korhonen, T. Application of Monte Carlo Simulation to NPP Fires. 10th Meeting of the International Collaborative Model Project (ICFMP). May 3–5, 2006, GRS, Garching, Germany, 18 slides.

Keski-Rahkonen, O. Review of Problems Not Yet Covered. 10th Meeting of the International Collaborative Model Project (ICFMP). May 3–5, 2006, GRS, Garching, Germany. 23 slides.

Research institute reports

Hostikka, S., Keski-Rahkonen, O. & Korhonen, T. 2003. Probabilistic Fire Simulator. Theory and User's Manual for Version 1.2, VTT Publications 503, VTT Building and Transport, Espoo. 72 p. + app. 1 p. ISBN 951-38-6235-6; 951-38-6236-4. <http://virtual.vtt.fi/inf/pdf/publications/2003/P503.pdf>.

Rönty, V., Keski-Rahkonen, O. & Hassinen, J.-P. Reliability of sprinkler systems – Exploration and analysis of data from nuclear and non-nuclear installations, Internal report, VTT Building and Transport. Espoo (2003). 89 p. + app. 9 p.

Nyysönen, T., Rajakko, J. & Keski-Rahkonen, O. On the reliability of fire detection and alarm systems – Exploration and analysis of data from nuclear and non-nuclear installations, Internal report, VTT Building and Transport. Espoo (2003). 63 p. + app. 6 p.

Hostikka, S. & Axelsson, J. Modelling of the radiative feedback from the flames in cone calorimeter, Nordtest Report, TR 540 (2003). 41 p.

Rönty, V., Keski-Rahkonen, O. & Hassinen, J.-P. Reliability of sprinkler systems – Exploration and analysis of data from nuclear and non-nuclear installations, VTT-WORK-15, VTT Working Papers 15, VTT, Espoo, 2004. 89 p. + app. 9 p. ISBN 951-38-6566-5. <http://virtual.vtt.fi/inf/pdf/workingpapers/2004/W15.pdf>.

Nyysönen, T., Rajakko, J. & Keski-Rahkonen, O. 2005. On the reliability of fire detection and alarm systems – Exploration and analysis of data from nuclear and non-nuclear installations, VTT-WORK-18, VTT Working Papers 18, VTT, Espoo 62 p. + app. 6 p. ISBN 951-38-6569-X. <http://virtual.vtt.fi/inf/pdf/workingpapers/2005/W18.pdf>.

Others

Keski-Rahkonen, O. & Mangs, J. Flame spread modeling and experiments at VTT. In: 8th International Comparative Fire Model Project Meeting at VTT, June 9–11, 2004 Espoo, Finland. 32 p. (Transparencies).

Mangs, J. Flame spread experiments. In: 8th International Comparative Fire Model Project Meeting at VTT, June 9–11, 2004 Espoo, Finland. 6 p. (Transparencies).

Hostikka, S., Korhonen, T. & Keski-Rahkonen, O. Two-Model Monte Carlo Simulation of Fire Scenarios. In: 8th International Comparative Fire Model Project Meeting at VTT, June 9–11, 2004 Espoo, Finland. 14 p. (Transparencies).

Korhonen, T. & Keski-Rahkonen, O. FDS vs CFAST: Flow oscillations (BM Exercise #2, case 1). In: 8th International Comparative Fire Model Project Meeting at VTT, June 9–11, 2004 Espoo, Finland. 15 p. (Transparencies).

Hostikka, S. Virtauslaskennan käyttö tulipalon simuloinnissa [Fire simulation using CFD]. *Teräsrakenne*, 25 (2002), nro 4, pp. 40–42. (In Finnish).

Hostikka, S. Fire Dynamics Simulator -ohjelman uusia ominaisuuksia ja sovelluksia [New properties and applications of Fire Dynamics Simulator -code], *Palontorjuntatekniikka*, Vol. 33 (2003) No: 3–4, pp. 23–25. (In Finnish).

Hassinen, J.-P. & Keski-Rahkonen, O. Sprinklerilaitteiston luotettavuusanalyysi II [Reliability Analysis of Sprinkler Systems, II], *Sprinkleri* 2003, pp. 11–21. (In Finnish).

Mangs, J. & Keski-Rahkonen, O. Noen massan määrittäminen savusta [Determination of mass of soot in smoke], *Palontorjuntatekniikka*. Vol. 33 (2003) No: 3–4, pp. 35–36, (In Finnish).

Mangs, J. & Keski-Rahkonen, O. Savun ja kosteuden vaikutus elektroniikkapiireihin [Influence of smoke and humidity on electronic circuits], *Palontorjuntatekniikka*. Vol. 33 (2003) No: 3–4, pp. 41–44. (In Finnish).

Paloposki, T. & Keski-Rahkonen, O. Teräspinnan emissiivisyyden mittaus [Measurement of emissivity of steel surfaces], *Teräsrakenteiden T&K-päivät*. 2.–3.9.2004 Seinäjoki. *Teräsrakenneyhdistys* (2004). 10 p. (In Finnish).

Keski-Rahkonen, O., Mangs, J. & Hostikka, S. 2005. Steps towards quantitative fire-PSA, Four Country Meeting, Ringhals NPP, Sweden, April 6–8, 2005. 37 p. (Transparencies).

Nyyssönen, T., Rajakko, J. & Keski-Rahkonen O. Paloilmoitinlaitteistojen luotettavuus. *Pelastustieto* 56 (2005), *Palontorjuntatekniikka-erikoisnumero*, *Palotutkimuksen päivät* 2005, pp. 14–19.

Mangs J. & Keski-Rahkonen O. Liekin leviämisen kokeita ja mallinnusta. *Pelastustieto* 56 (2005), *Palontorjuntatekniikka-erikoisnumero*, *Palotutkimuksen päivät* 2005, pp. 61–64.

Korhonen, T., Hostikka, S. & Keski-Rahkonen O. Poistumisaikalaskelmat palotilanteissa. *Pelastustieto* 56 (2005), *Palontorjuntatekniikka-erikoisnumero*, *Palotutkimuksen päivät* 2005, pp. 106–110.

Principles and practices of risk-informed safety management (PPRISMA):

Scientific publications

Rosqvist, T. On the use of expert judgement in the qualification of risk assessment. Dissertation for the degree of Doctor of Technology. VTT Publications 507, Espoo, 2003. 48 p. + app. 82 p. ISBN 951-38-6243-7; 951-38-6244-5. <http://virtual.vtt.fi/inf/pdf/publications/2003/P507.pdf>.

Conference papers

Helminen, A. Giving reliability estimates for digital devices and using the estimates in licensing. In: Proceedings of IAEA Technical Meeting held in Espoo, 2005. November 22–24, 2005, Espoo, Finland.

Helminen, A. Quantitative reliability estimation of a computer-based motor protection relay using Bayesian networks. PSA Slotsmöte 2003, Naantali, Finland, June 10–11, 2003. 12 p.

Helminen, A., Gran, B. A., Kristiansen, M. & Winther, R. Use of operational data for the assessment of pre-existing software. Paper presented at the EHPG meeting of Halden Reactor Project, Sandefjord, Norway, May 2004. 10 p.

Helminen, A. & Pulkkinen, U. Quantitative reliability estimation of a computer-based motor protection relay using Bayesian networks. SAFECOMP 2003 – Computer Safety, Reliability and Security, Edinburgh, United Kingdom, Sept. 23–26, 2003. 11 p.

Holmberg, J.-E. PPRISMA summary report. In: Rätty, H. & Puska, E. K. (eds.). SAFIR, The Finnish Research Programme on Nuclear Power Plant Safety 2003–2006, Interim Report, VTT Research Notes 2272. VTT Processes. Espoo (2004). Pp. 266–272. ISBN 951-38-6515-0; ISSN 1235-0605. <http://virtual.vtt.fi/inf/pdf/tiedotteet/2004/T2272.pdf>.

Holmberg, J., Himanen, R., Kupila, J. & Pyy, P. Analysis of severe accident management actions – a method for the treatment of the level 1/2 interface. PSA Slotsmöte 2003, Naantali, Finland, June 10–11, 2003. 10 p.

Holmberg, J. & Hukki, K. Interdisciplinary Expert Collaboration Method (IECM) for Supporting Human Reliability Analysis in Fire PSA. In: Proc. of International Topical Meeting on Probabilistic Safety Analysis (PSA 05), September 11–15, 2005, San Francisco, California, American Nuclear Society, Inc., La Grange Park, Illinois, USA, 2005. ISBN 0-89448-690-X.

Holmberg, J.-E. & Männistö, I. Risk-informed categorisation. In: Rätty, H. & Puska, E. K. (eds.). SAFIR, The Finnish Research Programme on Nuclear Power Plant Safety 2003–2006, Interim Report, VTT Research Notes 2272. VTT Processes. Espoo (2004). Pp. 273–280. ISBN 951-38-6515-0; ISSN 1235-0605. <http://virtual.vtt.fi/inf/pdf/tiedotteet/2004/T2272.pdf>.

Hukki, K. & Holmberg, J. Development of Management of Nuclear Power Plant Fire Situations. In: Spitzer, C., Schmocker, U. & Dang, V. N. (eds.). Probabilistic Safety Assessment and Management 2004. Proceedings of the Probabilistic Safety Assessment and Management Conference PSAM 7 – ESREL '04, Berlin, Germany, June 14–18, 2004. Springer-Verlag London Ltd. Pp. 376–382.

Knochenhauer, M., Holmberg, J.-E., Hultqvist, G. & Ingemarson, I. The validity of safety goals, PSAM 8, May 14–19, 2006, New Orleans, Louisiana, USA, ASME.

Laakso, K. Analysis of maintenance history for identification and prevention of human CCFs originating from modifications and maintenance. In: the Joint OECD/NEA/CSNI WGOE & SEGHOFF Workshop at OECD Headquarters, La Muette. "Modifications at Nuclear Power Plants – Operating Experience, Safety Significance and the Role of Human Factors" Paris, France, 6–8 October, 2003. 16 p.

Laakso, K. Systematic analysis and prevention of human errors and common cause failures in relation to maintenance. Paper presented at the OECD/NEA/CSNI Workshop "Better Nuclear Plant Maintenance: Improving Human and Organisational Performance" at Ottawa (CAN) on 3–5 October, 2005. 19 p.

Laakso, K. & Luukkanen, P. Development of maintenance strategies for a nuclear power plant. In: Congress report of 18th Euromaintenance 2006 and 3rd WorldCongress of Maintenance. 20–22th June 2006. Basel, Switzerland. MM Support GmbH, CH-300 Bern. Pp. 495–502.

Wahlström, B. IAEA TWG-NPPCI activities within computer security, IAEA Technical Meeting on Cyber Security of Nuclear Power Plant Instrumentation, Control, and Information Systems, Idaho Falls, Idaho USA, October 17–20, 2006.

Research institute reports

Helminen, A. Case study on reliability estimation of computer-based device for probabilistic safety assessment. VTT TUO62-051375. 2.11.2005. 30 p. + app. 2 p. (To be published in STUK series).

Helminen, A. General description of a reliability estimation case study for PSA. Report BTUO62-033289, VTT Industrial Systems, Espoo. 13 p.

Björkman, K. Long Mission Time Reliability. Report VTT-R-10134-06, VTT, Espoo, 2006. 32 p.

Haapanen P., Helminen A. & Pulkkinen U. Quantitative reliability assessment in the safety case of computer-based automation systems. Report STUK- YTO-TR 202, Radiation and nuclear safety authority, Helsinki, 2004.

Helminen A. & Myötyri E. Yhteenveto ohjelmoitavien järjestelmien luotettavuuden arviointi aivoriihteävästä. Tutkimusselostus BTUO62-032998, VTT Tuotteet ja tuotanto, Espoo. 19 p. (In Finnish).

Helminen, A. & Pulkkinen, U. Reliability assessment using bayesian networks. Case study on quantitative reliability estimation of a software-based motor protection relay. Report STUK- YTO-TR 198, Radiation and nuclear safety authority, Helsinki, 2003. 28 p. + app. 3 p.

Holmberg, J.-E. HRA data collection – experience and needs in Finland. Report BTUO62-031145, VTT Industrial Systems, Espoo. 4 p.

Holmberg, J.-E., Myötyri, E. & Pulkkinen, U. A study on comparison of risk importance measures and safety classification of functions and components at a nuclear power plant. Report BTUO62-031210, VTT Industrial Systems, Espoo. 18 p.

Hukki, K. & Holmberg, J. Palotilanteiden hallinta ydinvoimalaitoksella. Valvomon toimintaedellytysten kehittämistä tukeva analysointi- ja arviointimenetelmä. Report BTUO62-021090, VTT Tuotteet ja tuotanto, Espoo. 28 p. + app. 15 p. (In Finnish).

Hukki, K. & Holmberg, J.-E. Systeminen näkökulma ydinvoimalaitoksen palotilanteiden riskitietoiseen hallintaan. Vuoden 2005 työraportti. Report VTT-R-06-00074, VTT, Espoo, 2006. 23 p. (In Finnish).

Hukki, K. & Holmberg, J. Ydinvoimalaitoksen palotilanteiden riskitietoinen hallinta. Hallinnan analysointi- ja arviointimenetelmän soveltaminen uuteen paloskenaarioon. Report BTUO62-041214, VTT Tuotteet ja tuotanto, Espoo. 17 p. + app. 14 p. (In Finnish).

Laakso, K. Inhimillisperäisten yhteisvikojen esteiden jatkoanalyysi kohteena Loviisan voimalaitos. (Follow-up analysis of the barriers of human originated common cause failures applied to Loviisa NPP.) VTT Research Report BTU062-031211. Espoo. 10.08.2004. 33 p. + app. 17 p. (In Finnish).

Laakso, K. Menetelmäkuvaus inhimillisperäisten vikaantumisten järjestelmällisestä tutkinnasta voimalaitoksen kunnossapitohistoriasta. Väkiraportti. Report TUO62-051364, VTT, 14.2.2006. (In Finnish).

Laakso, K. Menetelmäkuvaus inhimillisten virheiden tunnistamisesta ja analyysistä kunnossapitohistorian avulla. Väkiraportti. (Loviisan voimalaitoksen LOTI tapauksessa, 1. versio). VTT TUO62-051364. 11.2.2005. 25 p.

Laakso, K. Systematic Analysis of Dependent Human Errors from the Maintenance History at Finnish NPPs – A Status Report. Report NKS-81(2003), Nordisk kernesikkerhedsforskning NKS, Roskilde. 24 p.

Laakso, K. & Rosqvist, T. Riskitietoisien ja kustannustehokkaan kunnossapito-ohjelman suunnittelu- menetelmän kehittäminen. Väkiraportti. VTT, 2006. 27 p. (In Finnish).

Laakso, K., Rosqvist, T. & Paulsen L. J. The Use of Condition Monitoring Information for Maintenance Planning and Decision-Making. Report NKS-80(2003), Nordisk kernesikkerhedsforskning NKS, Roskilde. 33 p.

Laakso, K. & Saarelainen, P. Inhimillisperäiset yhteisviat kunnossapitotoiminnan yhteydessä. Kunnossapito-historian järjestelmällinen tutkinta ja analyysi Loviisan voimalaitokselle (Human originated common cause failures related to maintenance activities. A systematic analysis of maintenance history for Loviisa nuclear power plant). VTT Research Report BTU062-041220, Espoo. 8.1.2004. 107 p. + app. 26 p. (In Finnish).

Männistö, I. & Holmberg, J.-E. Long mission time reliability, pre-study. VTT-R-00862-06. 27.1.2006. 32 p.

Männistö, I. Optimization based approach on classification tasks. Report BTU062-031196, VTT Industrial Systems, Espoo. 36 p.

Rosqvist, T. & Laakso, K. The Burden to Importance Ratio – a demonstrative study on BIR application for resource allocation of condition based maintenance. VTT Research Report BTU062-031189. Espoo, 10.08.2004. 19 p.

Simola, K. & Pulkkinen, U. Risk-informed decision making – a pre-study. Report NKS-93(2004), Nordisk kernesikkerhedsforskning NKS, Roskilde. 15 p. + app. 12 p.

Simola, K. & Pulkkinen, U. Summary of on-going activities in risk-informed decision making. Report BTU062-031205, VTT Industrial Systems, Espoo. 3 p. + app. 12 p.

Others

Laakso, K. Euromaintenance 11.5.-13.5.2004. Huomioita konferenssimatkalta. (Notes from a conference journey). 3 p. Kunnossapito 5/2004. Pp. 65–67. (In Finnish).

Laakso, K. Kustannustehokkuutta ja käytettävyyttä kokemuspohjaisella kunnossapitoanalyysillä. Kunnossapito 4/2003, pp. 40–43. (In Finnish).

Laakso, K., Simola, K. & Hänninen, S. Maintenance Analysis of Technical Systems. Kunnossapito 5/2002. Maintenance Research in Finland. Pp. 49–51.

Myötyri, E. Measures for structural properties of systems. M.Sc. Thesis. Helsinki University of Technology – Department of engineering physics and mathematics, Espoo, 2003. 52 p. + app. 20 p.

Männistö, I. Risk-informed classification of components of nuclear power plants. Diplomityö, Teknillinen korkeakoulu, Espoo, 2005.

Leino, M. & Laakso, K. Inhimillisperäisten vikaantumisten tutkinta Loviisan voimalaitoksen vuoden 2003 kunnossapitohistorian avulla. 30 s. + Liite A_B.xls. 1.6.2005.

Proceedings of IAEA Technical Meeting held in Espoo, 2005. November 22–24, 2005, Espoo, Finland. <http://iaea-nppci-espoo2005.vtt.fi/index.htm>.

Papers in review or in print

Holmberg, J.-E. PPRISMA summary report. In: Rätty, H. & Puska, E. K. (eds.). SAFIR, The Finnish Research Programme on Nuclear Power Plant Safety 2003–2006, Final Report, VTT Research Notes. VTT. Espoo (2006). 8 p.

Hukki, K., Holmberg, J.-E. Interdisciplinary development of risk-informed management of fire situations. In: Rätty, H. & Puska, E. K. (eds.). SAFIR, The Finnish Research Programme on Nuclear Power Plant Safety 2003–2006, Final Report, VTT Research Notes. VTT. Espoo (2006). 10 p.

Laakso, K. Systematic analysis and prevention of human originated common cause failures in relation to maintenance activities at Finnish nuclear power plants. Nov. 2005. To be published in STUK series. 39 p.

Assessment smart device software (ASDES, 2005–2006):

Research institute reports

Holmberg, J.-E., Pulkkinen, U., Bloomfield, R., Guerra, S. & Sheridan, D. Description of the ASDES case studies. VTT-R-00923-06, VTT, Espoo, 2006.

SAFIR Administration and information (SAHA):

Research institute reports

Puska, E. K. SAFIR, The Finnish Research Programme on Nuclear Power Plant Safety, Annual Plan 2003. Espoo: VTT Processes Project Report PRO1/P7007/03. 26 p. + app. 102 p.

Puska, E. K. SAFIR, The Finnish Research Programme on Nuclear Power Plant Safety, Annual Report 2003. Espoo: VTT Processes Project Report PRO1/P7001/04. 58 p. + app. 119 p.

Puska, E. K. SAFIR, The Finnish Research Programme on Nuclear Power Plant Safety, Annual Plan 2004. Espoo: VTT Processes Project Report PRO1/P7002/04. 22 p. + app. 130 p.

Puska, E. K. SAFIR, The Finnish Research Programme on Nuclear Power Plant Safety, Annual Report 2004. Espoo: VTT Processes Project Report PRO1/P1014/05. 69 p. + app. 138 p.

Puska, E. K. SAFIR, The Finnish Research Programme on Nuclear Power Plant Safety, Annual Plan 2005. Espoo: VTT Processes Project Report PRO1/P1015/05. 22 p. + app. 157 p.

Puska, E. K. SAFIR, The Finnish Research Programme on Nuclear Power Plant Safety, Annual Report 2005. Espoo: VTT Research Report VTT-R-08877-06. 78 p. + app. 88 p.

Puska, E. K. SAFIR, The Finnish Research Programme on Nuclear Power Plant Safety, Annual Plan 2006. Espoo: VTT Research Report VTT-R-06393-06. 33 p. + app.

Räty, H. & Puska, E. K. (eds.). SAFIR, The Finnish Research Programme on Nuclear Power Plant Safety 2003–2006, Interim Report, VTT Research Notes 2272. VTT Processes. Espoo (2004). Pp. 273–280. ISBN 951-38-6515-0; ISSN 1235-0605. <http://virtual.vtt.fi/inf/pdf/tiedotteet/2004/T2272.pdf>.

Others

Puska, E. K. SAFIR koostaa parasta kansallista alan asiantuntemusta. *Energia*. (2003) 4–5, p. 35. (In Finnish).

Appendix B: Finnish members in international committees and working groups in 2006

OECD/Nuclear Energy Agency

Committee on Nuclear Regulatory Activities (CNRA), J. Laaksonen STUK (Chairman), L. Reiman, STUK

- * Working Group on Inspection Practices, S. Suksi, STUK
- * (CNRA/CSNI) Task Group on Safety Performance Indicators, S. Suksi, STUK
- * Task Group on Regulatory Effectiveness Indicators, K. Koskinen, STUK
- * Working Group on Operating Experience (WGOE), J. Turpeinen, Loviisa NPP, T. Eurasto, STUK

Committee on the Safety of Nuclear Installations (CSNI) T. Vanttola, VTT, K. Valtonen, STUK

- * Working Group on Risk Assessment, Jan-Erik Holmberg, VTT, R. Virolainen, STUK
- * Working Group on Analysis and Management of Accidents, I. Karppinen, VTT, N. Lahtinen, STUK
- * Working Group on Integrity and Ageing of Components and Structures, R. Rintamaa, VTT, R. Keskinen, STUK
- * Group on Integrity of Metal Components and Structures, J. Solin, VTT, R. KeskinenRantala, STUK
- * Subgroup Group on Ageing of Concrete Structures, E. Vesikari, VTT
- * Working Group on Human and Organisational Factors (WGHO), L. Norros, VTT, N. Koivula, STUK
- * Special Expert Group on Fuel Safety Margins, S: Kelppe, VTT, K. Valtonen, STUK
- * Writing Group of the CSNI State-of-the-Art Report on Nuclear Aerosols in Reactor Safety, J. Jokiniemi, A. Auvinen, VTT
- * Senior Group of Experts on Nuclear Safety Research (SESAR) Report on Support Facilities for Existing and Advanced Reactors (SFEAR), T. Vanttola, VTT

Committee on Radiation Protection and Public Health (CRPPH), O. Vilkkamo, STUK

Nuclear Development Committee (NDC), J. Aurela, KTM, M. Anttila, VTT

- * Expert Group on the Impact of Nuclear Power Plant Life Extension

Nuclear Science Committee (NSC), M. Anttila, VTT, R. Mattila, STUK

- * Working Party on Scientific Issues in Reactor Systems (WPRS), A. Daavittila, VTT, J. leppänen, VTT
- * Working Party for Nuclear Criticality Safety, R. Mattila, STUK, A. Ranta-Aho

VTT

- * Task force on scientific issues of fuel behaviour, S. Kelppe, VTT
- * Expert Group on Structural Materials for Innovative Nuclear Systems (SMINS), L. Heikinheimo, VTT

Information System on Occupational Exposure (ISOE), V. Riihiluoma, STUK, K. Alm-Lytz, STUK

NEA Projects

CABRI Water Loop Project 2000–2007. Umbrella Agreement with OECD, bilateral Agreement with IPRN; jointly with Fortum Power and Heat Oy and Teollisuuden Voima Oy. K. Valtonen STUK (Steering Committee), S Kelppe VTT (Technical Advisory Group)

Halden Reactor Project, Management Board, K. Valtonen, STUK, Halden Programme Group, O. Ventä, T. Vanttola, VTT

- * *Advanced Monitoring techniques for Application in Material Studies*, P. Kinnunen, VTT
- * *Irradiation Assisted Stress Corrosion Cracking*, P. Aaltonen, VTT
- * *Fuel performance analysis*, S. Kelppe, VTT
- * *Reliability of software based control systems*, A. Helminen
- * *Integrated system validation, Innovative Displays*, L. Norros & P. Savioja, VTT

SCIP Project on Fuel Integrity, A. Knuutila, VTT

ROSA Project on Thermal Hydraulic Transients, I. Karppinen, VTT, E. Virtanen, STUK

PKL Project on PWR Thermal Hydraulics, Boron Dilution, P. Junninen, VTT, E. Virtanen, STUK

SETH Project on Containment, Management Board, E. Virtanen, STUK, Programme Review Group, H. Purhonen, LUT, E. Virtanen, STUK

PSB-VVER VVER 1000 Thermal-Hydraulic Transients, H. Holmström, VTT

MASCA-2 Project on Severe Accidents (in-vessel), Programme Review Group (Chairman), Management Board, H. Tuomisto, Fortum Nuclear Services

MCCI Project on Severe Accidents (ex-vessel), Management Board, Programme Review Group, I. Lindholm, VTT

PRISME Project on Fire Propagation, O. Keski-Rahkonen, VTT

COMPSIS Project, Database on computerised system events, H. Takala, STUK

FIRE Project, Database on Fire Events, J. Marttila, STUK

ICDE Project, Database on Common-Cause Failure Data Exchange, K. Jänkälä, FORTUM Nuclear Services, J. Pesonen, TVO, R. Virolainen, STUK

OPDE Project, Database on Piping Failures, R. Keskinen, STUK

Generation IV International Forum (GIF)

Risk and Safety Working Group (RSWG), A. Daavittila/VTT

Economic Modelling Working Group (EMWG), R. Tarjanne/LUT

Supercritical-Water-Cooled Reactor Chemistry and Materials Project Management Board (SCWR), L. Heikinheimo/VTT

Senior regulators' Working Group, J. Laaksonen/STUK

International Atomic Energy Agency

Nuclear Safety Standards Committee, L. Reiman, STUK

International Nuclear Event Scale (INES), K. Tossavainen, STUK

Incident Reporting System (IRS), T. Eurasto, STUK

Incident Reporting System for Research Reactors (IRSRR), K. Alm-Lytz, STUK

Technical Working Group on Nuclear Power Plant Control and Instrumentation (TWG-NPPCI),
B. Wahlström (Chairman), VTT

Co-ordinated Research Projects

- * *International Working Group of Life Management of Nuclear Power Plants (IWG-LMNPP)*, K. Wallin
- * *High temperature On-line Monitoring of Water Chemistry and Corrosion, (WACOL)*, P. Kinnunen, VTT
- * *CRP Coordinated Research Programme “Assuring Structural Integrity of Reactor Pressure Vessels”*, T. Planman, VTT
- * *CRP Coordinated Research Programme “Scientific Basis and Engineering Solutions for Cost-effective Assessments of Software Based I&C Systems”*, H. Harju, VTT
- * *CRP FUMEX II; Coordinated Research Programme on “Improvement of models used for fuel behaviour simulation”*, S. Kelppe VTT
- * *International Working Group on Water Reactor Performance and Technology (IWGFPT)*, R. Teräsvirta, Fortum, S. Kelppe, VTT

FARO Expert Group, T. Karjunen, STUK

Commission of the European Communities

DG Energy and Transport, European Forums

- * *European NDE Forum (ENDEF)*, Pentti Kauppinen, VTT

DG Research

- * *JRC Board of Governors*, Erkki KM Leppävuori, VTT
- * *Networks coordinated by JRC/IE*, R. Rintamaa, VTT
- * *European Network for Ageing Materials Evaluation & Studies (AMES)*, T. Planman, VTT
- * *Network for Evaluating Steel Components (NESC)*, AG1 Inspection, Pentti Kauppinen, VTT
- * *European Network for Inspection Qualification (ENIQ) Steering committee* Kari Hukkanen, Teollisuuden Voima Oy
- * *European Network for Inspection Qualification (ENIQ) TGR, ENIQ task group for Risks*, M. Sarkimo and K. Simola VTT
- * *Effective application of TOFD method for weld inspection at the manufacturing of pressure vessels*, P. Kauppinen, VTT

Nuclear Fission Safety in the Sixth Framework Programme

- * *Consultative Committee Euratom-Fission (CCE-Fission)*, J. Aurela, A. Väättäin, KTM

Nuclear Regulators Working Group (NRWG), P. Koutaniemi, STUK

- * *Task Force on NDT Qualification Programmes*, O. Valkeajärvi, STUK
- * *Task Force on Safety Critical Software – Licensing Issues*, P. Suvanto, STUK

Group of Experts under Article 31 of the Euratom Treaty, O. Vilkkamo, STUK

JRC-Ispra-ISID, Reactor Safety Programme Users Advisory Board (RSPUAB), R. Virolainen, STUK

Phebus FP Project, J. Jokiniemi, A. Auvinen, VTT

- * Scientific analysis working group (SAWG).
- * Bundle interpretation circle (BIC).
- * Circuit and containment interpretation circle (CACIC).
- * Containment chemistry interpretation circle (CCIC).
- * Air ingress working group (AIWG).
- * Air ingress task force (AITF).

Cooperation on VVER Reactor Physics and Dynamics (AER)

Scientific council, H. Rätty, VTT, P. Siltanen, Fortum NS

Nordic Nuclear Safety Research (NKS)

Steering group, U. Ehrnstén, VTT Industrial Systems, J. Aurela, KTM, O. Vilkkamo, STUK, H. Raumolin, Fortum

Research Programme on Reactor Safety, 2002–, N. Bergroth (Programme manager), Fortum Nuclear Services

TUD (Informationssystem för Tillförlitlighet, Underhåll och Drift), J. Pesonen, TVO

NPSAG (Nordiska PSA gruppen), R. Himanen, J. Pesonen, TVO

Scientific Communities

European Safety, Reliability and Data Association (ESReDA)

- * *Executive Committee, Organisation of yearly ESReDA Seminars*, K. Simola, VTT

Probabilistic safety assessment and management (PSAM) conferences

- * *Organising committee*, R. Virolainen, STUK

Technical Program Committee on PSAM6 & ESREL 2003 Conferences, Member, J. Vaurio, Fortum Power and Heat

European Structural Integrity Society (ESIS), K. Wallin, H. Talja, VTT

- * *Development of European “standards” on fracture mechanics, information exchange*. VTT co-chairs the Materials Task Group and participates in the Numerical task Group

International Group for Radiation Damage Mechanisms in Pressure Vessel Steels (IGRDM), K. Wallin, M. Valo, VTT

ASTM E-10, M. Valo, VTT

- * *committee E-10 on Nuclear Technology* concentrates on monitoring of irradiation embrittlement using small specimens and develops related standards.

ASTM E-8, K. Wallin, VTT

- * committee E-8, Fatigue and Fracture

ESIS TC1 Elastic plastic fracture, K. Wallin, VTT, chairman

ASME, R. Rintamaa, VTT

Cooperation with various institutes

Leningrad NPP Sosnovyj Bor, Russia

- * *The Finnish-Russian co-operation on integrity of pressurised components*, P. Kauppinen, VTT

Institute de Radioprotection et de Sûreté Nucléaire, Cadarache, France

- * *Design and testing of ruthenium measuring instrumentation*, A. Auvinen, J. Jokiniemi, U. Backman, VTT
- * *Study of the behaviour of highly irradiated fuels in case of reactivity accident and the SCANAIR computer code*, S. Kelppe, VTT
- * *OECD-IPSN CABRI Water Loop Project 2000–2007. Umbrella Agreement with OECD, bilateral Agreement with IPSN; jointly with Fortum Power and Heat Oy and Teollisuuden Voima Oy.* K. Valtonen STUK (Steering Committee), S. Kelppe VTT (Technical Advisory Group)

Research Institute of Technology, NITI, Russia

- * *Scientific cooperation on thermal-hydraulic experiments*, H. Purhonen, LTKK

US Nuclear Regulatory Commission (USNRC)

- * *PIRT Panel (on fuel burnup)*, K. Valtonen, STUK
- * *Code Application and Maintenance (CAMP)*, H. Holmström, VTT
- * *Co-operative Severe Accident Research Programme (CSARP)*, I. Lindholm, VTT
- * *FRAPCON-3/FRAPTRAN Code Users' Group*, S. Kelppe, VTT
- * *FRAPTRAN/GENFLO Fuel Performance CodeDevelopment*, S. Kelppe, VTT
- * *International Collaborative Project to Evaluate Fire Models for Nuclear Power Plant Applications organized by USNRC*, O. Keski-Rahkonen, VTT

Electric Power Research Institute (EPRI)

- * *Advanced Containment Experiments, Extension (ACEX)*, I. Lindholm, VTT
- * *Melt Attack and Coolability (MACE)*, I. Lindholm, VTT
- * *Cooperative Irradiation Assisted Stress Corrosion Cracking (IASCC) Research Programme (CIR)*, P. Aaltonen, VTT

ASN (Autorité de Sûreté Nucléaire), Ranska

- * *Groupe Permanent d'Experts pour les Réacteurs Nucléaires*, J. Hyvärinen, STUK

Swedish Nuclear Power Inspectorate (SKI), Sydkraft, OKG and Vattenfall Ab, Sweden

- * *SKI Forskningnämnd*, U. Ehrnstén, VTT
- * *SKI Reaktorsäkerhetsnämnd*, L. Reiman, STUK, K. Wallin, VTT

Fraunhofer-Institut für Werkstoffmechanik (IWM), Germany

- * *Structural analysis and computational fracture mechanics, especially development of new material models*, H. Talja, VTT

University of Illinois, USA

- * *Computational fracture mechanics, assessment of damage*, K. Wallin, VTT

Forschungszentrum Karlsruhe (FZK), Germany

- * *Hydrogen detonation simulation*, A. Silde, VTT

VGB SWR- Arbeitskreis, Germany

- * A. Reinvall, TVO

ITU, Karlsruhe, A. Auvinen, J. Jokiniemi, VTT

- * *Revaporisation of fission products from Phebus FP samples*

National Institute of Standards and Technology (NIST), USA

- * *Development of Fire Dynamics Simulator*
- * *Direct numerical simulation of flame spread on cylindrical wood rods*. S. Hostikka, VTT

ALARA Engineering and Advanced Nuclear Technology, Sweden, P. Kinnunen, VTT Industrial Systems

- * *Development of a predictive model of activity incorporation and corrosion phenomena*

IVF – Industriforskning och utveckling AB

- * *No Lead in Nordic Electronics*, A. Turtola VTT

SINTEF – Stiftelsen for industriell og teknisk forskning ved Norges tekniske høgskole

- * *No Lead in Nordic Electronics*, A. Turtola VTT

DELTA – Danish Electronics, Light and Acoustics

- * *No Lead in Nordic Electronics*, A. Turtola VTT

Other co-operation

European Nuclear Installations Safety Group (ENIS-G), P. Koutaniemi, STUK

EC/TC45/SC45A/Working Group A3, H. Heimbürger, STUK

IEC/TC45/SC45A/Working Group A10, H. Palmén, VTT

IEC/TC45/SC45A, Nuclear Instrumentation Committee (SESKO), P. Suvanto, STUK

European Working Group on Reactor Dosimetry – Programme Committee (EWGRD-PC), T. Serén, VTT

Working Group on Reactor Dosimetry for VVER Reactors (WGRD-VVER), T. Serén, VTT

European Network of Testing Facilities for the Quality Checking of Radioactive Waste Packages (ENTRAP), A. Tiitta, VTT

International Co-operative Group on Environmentally Assisted Cracking of Light Water Reactor Materials (ICG-EAC), U. Ehrnstén, VTT

Nordic Reactor Physics Meetings “Reactor Physics Calculations in the Nordic Countries”, R. Höglund, VTT

European Association of Cognitive Ergonomics (EACE), L. Norros, VTT

New Technology and Work (NeTWork), L. Norros, VTT

Nordic ALEX-group on advanced alara-princip in chemistry and radiation (Westinghouse Atom, Alara-Engineering, WA-BWR-plants) A. Reinval, TVO

The human factors network for the process industries (PRISM), co-ordinated by the European Process Safety Centre (EPSC), K. Ruuhilehto, VTT

BWR OG PSA (BWR Owners Group, PSA task) R. Himanen, TVO

ISTC Project #833 METCOR “Investigation of corium melt interaction with NPP reactor vessel steel”, NITI, Sosnovy Bor, Russia, Collaborator and Steering Committee Member, H. Tuomisto, Fortum Nuclear Services

MSWI (Melt-Structure-Water Interaction) Project, KTH, Stockholm, Advisory Group, H. Tuomisto, Fortum Nuclear Services

VVER Forum’s WG on the use of PSA, R. Virolainen (chairman) and A. Julin, STUK

Appendix C: Academic degrees awarded in the projects 1.1.2003–30.11.2006

Enhanced methods for reactor analysis (EMERALD)

Doctor of Technology:

Hämäläinen, A. Applying thermal hydraulics modeling in coupled processes of nuclear power plants. Espoo: Technical Research Centre of Finland, 2005. 103 p. + app. 99 p. (VTT Publications 578. ISBN 951-38-6667-X; ISSN 1235-0621). (Lappeenranta University of Technology – Department of Energy and Environmental Technology)

Licentiate in Technology:

Leppänen, J. Systematic comparison of evaluated nuclear data files. Helsinki University of Technology, Licentiate's Thesis, 28 May 2004. 104 p. (VTT Project Report PRO1/P7009/04).

Master of Science in Technology:

Ranta-aho, A. Validation of reactor physics codes for predictions of isotopic compositions of high burnup LWR fuels. Helsinki University of Technology, Master's Thesis, 1 February 2004. 147 p. (VTT Project Report PRO1/P7006/04).

High-burnup upgrades in fuel behaviour modelling (KORU)

Master of Science in Technology:

Kekkonen, L. Master's Thesis, Validation of the Fission Gas Release Model of the advanced IMAGINE Model Implemented in the ENIGMA Fuel Performance Model, Helsinki University of Technology, Department of Engineering Physics and Mathematics.

Integrity and lifetime of reactor circuits (INTELI)

Doctor of Technology:

Moilanen, P. Pneumatic servo-controlled material testing device capable of operating at high temperature water and irradiation conditions. Doctoral thesis. VTT Publications 532, Espoo 2004. 154 p. ISBN 951-38-6384-0; 951-38-6385-9.
<http://virtual.vtt.fi/inf/pdf/publications/2004/P532.pdf>.

Toivonen, A. Stress corrosion crack growth rate measurement in high temperature water using small preracked bend specimens. Doctoral thesis. VTT Industrial Systems, Espoo 2004. VTT Publications 531. 206 p. + app. 9 p. ISBN 951-38-6382-4; 951-38-6383-2.
<http://virtual.vtt.fi/inf/pdf/publications/2004/P531.pdf>.

Master of Science in Technology:

Vepsä, A. Mechanical vibration in a piping system. Helsinki University of Technology, Espoo 2004.

Thermal hydraulic analysis of nuclear reactors (THEA)

Master of Science in Technology:

Junninen, P. Model to simulate small break experiment in PKL test facility with APROS code, STUK-YTO-TR 214, 2005. (Lappeenranta University of Technology) (funded by STUK). 53 p. (In Finnish).

Takasuo, E. Modelling of pressurizer using APROS and TRACE thermal hydraulic codes, 2005. (Lappeenranta University of Technology, Department of Energy and Environmental Technology). 119 p.

Hillberg, S. Modelling of Hydro-accumulator in Nuclear Power Plant. 2006 (Lappeenranta University of Technology, Department of Energy and Environmental Technology). (In Finnish).

Condensation pool experiments (POOLEX)

Master of Science in Technology:

Nurminen, T. Passive Safety Features of VVER-640 Reactors. Lappeenranta, 2003. (Lappeenranta University of Technology). 80 p. (In Finnish).

Räsänen, A. Measurement System for Steam Condensation. Lappeenranta, 2004. (Lappeenranta University of Technology). 83 p. + app. 2 p. (In Finnish).

Pikkarainen, M. Heat Transfer Analysis of the EPR Core Catcher Test Facility Volley. Lappeenranta, 2006. (Lappeenranta University of Technology). 89 p. + app. 9 p.

Participation in Development of European Calculation Environment (ECE)

Master of Science in Technology:

Turtiainen K. Modelling of a Hydrogen Catalytic Recombiner for Nuclear Power Plant Containment Studies; Case: Siemens FR90/1-150 Recombiner Model in TONUS 0D Code. Lappeenranta 2005. (Lappeenranta University of Technology). 133 p. + app. 20 p.

Wall Response to Soft Impacts (WARSI)

Master of Science in Technology:

Eriksson, E. Missiilin murskautumisvoima. Tampere University of Technology, Department of Civil Engineering, Structural Mechanics, Tampere 2005. 104 p. + app.

Severe Accidents and Containment Integrity (SANCY)

Master of Science in Technology:

Sevón, T. Molten Core – Concrete Interactions in Nuclear Accidents: Theory and Design of an Experimental Facility, Helsinki University of Technology, Department of Engineering Physics and Mathematics. Master's Thesis.

Development of Aerosol Models to Nuclear Applications (AMY)

Master of Science in Technology:

Siltanen, S. Influence of Uncertainty of Calculation Parameters in Modelling on Radioactive Releases in Severe Accident Conditions. Helsinki University of Technology, Master's Thesis, 2 December 2003. 93 p. + app. (In Finnish).

Karttunen, V. Validation of a fission product revaporization model, Master's Thesis, Helsinki University of Technology, Espoo, January 10, 2005.

Behaviour of fission products in air-atmosphere (FIKA)

Doctor of Philosophy:

Backman, U. Studies on nanoparticles synthesis via gas-to-particle conversion, Academic dissertation, University of Helsinki, Faculty of Science, Department of Physical Sciences, Espoo 2005. VTT publications 562. 45 p. + app. 62 p. ISBN 951-38-6441-3; 951-38-6442-1. <http://virtual.vtt.fi/inf/pdf/publications/2005/P562.pdf>.

Interaction approach to development of control rooms (IDEC)

Master of Science in Technology:

Savioja, P. Käyttäjäkeskeiset menetelmät monimutkaistenjärjestelmien vaatimusten kuvaamisessa. Espoo, 2003. (Helsinki University of Technology). 119 p.

Potential of fire spread (POTFIS)

Doctor of Philosophy:

Mangs, J. 2004. On the fire dynamics of vehicles and electrical equipment. VTT Publications 521, VTT Building and Transport, Espoo, 62 p. + app. 101 p. (University of Helsinki). ISBN 951-38-6273-9; 951-38-6274-7. <http://virtual.vtt.fi/inf/pdf/publications/2004/P521.pdf>.

Principles and Practices of Risk-Informed Safety Management (PPRISMA)

Doctor of Technology:

Rosqvist, T. On the use of expert judgement in the qualification of risk assessment. Espoo: Technical Research Centre of Finland, 2003. (Helsinki University of Technology). VTT Publications 507. 48 p. + app. 82 p. ISBN 951-38-6243-7; 951-38-6244-5. <http://virtual.vtt.fi/inf/pdf/publications/2003/P507.pdf>.

Master of Science in Technology:

Männistö, I. Risk-informed classification of components of nuclear power plants. Espoo, 2005. (Helsinki University of Technology – Department of engineering physics and mathematics)

Myötyri, E. Measures for structural properties of systems. Espoo, 2003. (Helsinki University of Technology – Department of engineering physics and mathematics). 52 p. + app. 20 p.

Appendix D: The steering group, the reference groups and the scientific staff of the projects

Steering Group of SAFIR – The Finnish Research Programme on Nuclear power Plant Safety 2003–2006

Kansallisen ydinvoimalaitosten turvallisuustutkimusohjelman SAFIR 2003–2006 johtoryhmä

Person	Organisation & Finnish abbreviation
Marja-Leena Järvinen, Chairperson ¹	Radiation and Nuclear Safety Authority of Finland (STUK)
<i>Lasse Reiman, Chairperson²</i>	<i>Radiation and Nuclear Safety Authority of Finland (STUK)</i>
<i>Timo Okkonen, Chairperson³</i>	<i>Radiation and Nuclear Safety Authority of Finland (STUK)</i>
Keijo Valtonen, ¹	Radiation and Nuclear Safety Authority of Finland (STUK)
Piia Moilanen	National Technology Agency of Finland (TEKES)
Reijo Munther	National Technology Agency of Finland (TEKES)
Timo Vanttola	Technical Research Centre of Finland (VTT)
Ulla Ehrnstén ⁴	Technical Research Centre of Finland (VTT)
<i>Heli Talja⁵</i>	<i>Technical Research Centre of Finland (VTT)</i>
Jari Tuunanen ⁶	Teollisuuden Voima Oy (TVO)
<i>Eero Patrakka⁷</i>	<i>Teollisuuden Voima Oy (TVO)</i>
Marjo Mustonen	Teollisuuden Voima Oy (TVO)
Harriet Kallio	Fortum Power and Heat Oy (Fortum P&H)
Jyrki Kohopää	Fortum Nuclear Services Oy (Fortum NS)
Rainer Salomaa	Helsinki University of Technology (TKK)
Riitta Kyrki-Rajamäki, Vice Chairperson	Lappeenranta University of Technology (LTY)
Anne Väätäinen	Finnish Ministry of Trade and Industry (KTM)
Jorma Aurela, KTM contact person	Finnish Ministry of Trade and Industry (KTM)

¹ Since August 4th, 2005

² Until August 3rd, 2005

³ Resigned from STUK during 2003

⁴ Replacing Heli Talja since 2005

⁵ On leave from 2005 until August 2006, replaced by Ulla Ehrnsten since June 1, 2006

⁶ Since 2005

⁷ During 2003–2004

SAFIR Reference Groups SAFIR tukiryhmät

1. Polttoaine ja reaktorisydän Reactor fuel and core

Risto Sairanen ¹	STUK	Chairperson
<i>Keijo Valtonen</i> ²	<i>STUK</i>	<i>Chairperson</i>
Pertti Siltanen	Fortum	Vice Chairperson
Nina Lahtinen	STUK	
Risto Teräsvirta	Fortum	
Martti Antila	Fortum	
Kari Ranta-Puska	TVO	
Mikael Solala	TVO	
Seppo Koski	TVO	
Markku Hänninen ³	VTT	
<i>Jaakko Miettinen</i> ⁴	<i>VTT</i>	
<i>Lena Hansson-Lyyra</i> ⁵	<i>VTT</i>	
Seppo Tähtinen ⁶	VTT	

¹ Since October 5th, 2005

² Until October 4th, 2005

³ Since 2005

⁴ During 2003–2004

⁵ During 2003–2005

⁶ Since 2006

2. Reaktoripiiri ja rakenteellinen turvallisuus Reactor circuit and structural safety

Martti Vilpas	STUK	Chairperson
Rainer Rantala	STUK	Vice Chairperson
Kirsti Tossavainen	STUK	
Jari Puttonen ¹	Fortum	
<i>Erkki Kaminen</i> ²	<i>Fortum</i>	
Alpo Neuvonen	Fortum	
Ossi Hietanen	Fortum	
Juho Hakala	TVO	
Erkki Muttilainen	TVO	
Olli Tiihonen ¹	VTT	
<i>Timo Pättikangas</i> ²	<i>VTT</i>	
Rauno Rintamaa	VTT	
<i>Kim Wallin</i> ²	<i>VTT</i>	
Liisa Heikinheimo ³	VTT	
Hannu Hänninen	TKK	
Jukka Tuhkuri	TKK	

¹ Since 2005

² During 2003–2004

³ Since 2006

3. Suojarakennus ja prosessiturvatoiminnot **Containment and process safety functions**

2003–2004

Olli Nevander	TVO	Chairperson
Juhani Hyvärinen	STUK	Vice Chairperson
Nina Lahtinen	STUK	
Hannu Ollikkala	STUK	
Lauri Pöllänen	STUK	
Heikki Sjövall	TVO	<i>Chairperson in 2003</i>
Petra Lundström	Fortum	
Olli Kymäläinen	Fortum	
Antti Daavittila	VTT	
Hanna Rätty	VTT	
Olavi Keski-Rahkonen	VTT	
Juhani Vihavainen	LTY	
Pekka H. Pankakoski	VTT	

2005–2006

3a. Thermal hydraulics **Termohydrauliikka**

Olli Nevander	TVO	Chairperson
Eero Virtanen	STUK	Vice Chairperson
Heikki Sjövall	TVO	
Nina Lahtinen	STUK	
Olli Kymäläinen	Fortum	
Timo Toppila	Fortum	
Juhani Hyvärinen	LTY	
Heikki Keinänen	VTT	
Hanna Rätty	VTT	
Antti Daavittila	VTT	

3b. Containment Suojarakennus

Risto Sairanen	STUK	Chairperson
Lauri Pöllänen	STUK	Vice Chairperson
Juhani Hyvärinen	STUK	
Tomi Routamo ¹	Fortum	
<i>Petra Lundström²</i>	<i>Fortum</i>	
Eerikki Raiko	Fortum	
Heikki Sjövall	TVO	
Anssi Paalanen	TVO	
Mika Pikkarainen	LTY	
Matti Pajari ³	VTT	
<i>Pekka H. Pankakoski⁴</i>	<i>VTT</i>	
<i>Klaus Rahka⁵</i>	<i>VTT</i>	
Olavi Keski-Rahkonen	VTT	

¹ Since October 5th, 2005

² Until October 4th, 2005

³ Since January 27, 2006

⁴ December 12th, 2005 – January 27, 2006

⁵ Until December 11th, 2005

4. Automaatio, valvomo ja tietotekniikka Automation, control room and information technology

Esko Rinttilä	Fortum	Chairperson
Olli Hoikkala	TVO	Vice Chairperson
Harri Heimbürger	STUK	
Juhani Hyvärinen ¹	STUK	
<i>Erik Lönnqvist²</i>	<i>STUK</i>	
Heimo Takala	STUK	
Jukka Kupila	STUK	
Martti Välisuo	Fortum	
Juha Miikkulainen	TVO	
Sixten Norrman	VTT	
<i>Risto Sairanen³</i>	<i>VTT</i>	
Olli Tiihonen	VTT	
Olavi Keski-Rahkonen	VTT	
Jari Hämäläinen ⁴	VTT	
<i>Jan-Erik Holmberg⁵</i>	<i>VTT</i>	

¹ Since 2006

² During 2003–2005

³ Resigned from VTT during 2003

⁴ Since 2005

⁵ During 2003–2004

5. Organisaatiot ja turvallisuuden hallinta Organisations and safety management

Matti Vartiainen	TKK	Chairperson
Anneli Leppänen	TTL	Vice Chairperson
Timo Eurasto	STUK	
Nina Koivula ¹	STUK	
<i>Kaisa Åstrand</i> ²	<i>STUK</i>	
<i>Jari Snellman</i> ³	<i>Fortum</i>	
Pekka Luukkanen	Fortum	
Markku Friberg ⁴	TVO	
Petri Koistinen ⁴	TVO	
Urho Pulkkinen	VTT	
Leena Norros	VTT	

¹ Since October 5th, 2005

² Until October 4th, 2005

³ Until September 28, 2006

⁴ Since 2005

6. Riskitietoinen turvallisuuden hallinta Risk-informed safety management

Reino Virolainen	STUK	Chairperson
Ilkka Niemelä	STUK	Vice Chairperson
Jouko Marttila	STUK	
Jussi Vaurio ³	Fortum	
Mika Yli-Kauhaluoma ⁴	Fortum	
Kalle Jänkälä	Fortum	
Risto Himanen	TVO	
Kari Taiainen	TVO	
Risto Huhtanen ¹	VTT	
<i>Ilona Lindholm</i> ²	<i>VTT</i>	
Arja Saarenheimo	VTT	
Olli Ventä	VTT	
Esko Mikkola	VTT	

¹ Since 2005

² During 2003–2004

³ During 2003–2006

⁴ Since 2006

Personnel and tasks in the SAFIR projects in 2003–2006

Enhanced methods for reactor analysis (EMERALD)

Kehittyneet reaktorianalyysimenetelmät

Research organisation: VTT

Project manager: Randolph Höglund, VTT

Deputy project manager: Antti Daavittila, VTT

Person	Org.	Task
Randolph Höglund, LicTech	VTT	Project manager, reactor physics, nodal methods, Nordic connections
Antti Daavittila, MScTech	VTT	Deputy project manager, reactor dynamics, development and validation of dynamics codes
Markku Anttila, MScTech	VTT	Reactor physics, cross sections, isotope concentrations, OECD/NEA connections: NDC, NSC
Anitta Härmäläinen, DTech	VTT	Reactor dynamics, circuit modelling, thermal hydraulic modelling for fuel transient codes, dynamics benchmarks
<i>Pasi Inkinen, student (2005)</i>	<i>VTT</i>	<i>Reactor Dynamics, 3D visualization tools</i>
<i>Elja Kaloinen, MScTech (retired March 31, 2006)</i>	<i>VTT</i>	<i>Reactor physics, nodal methods, reactor physics in dynamics codes</i>
Petri Kotiluoto, MSc (since 2004)	VTT	Reactor physics, transport methods, development of MultiTrans
Jaakko Leppänen, LicTech	VTT	Reactor physics, cross sections, use of Monte Carlo methods in burnup calculations, development of Monte Carlo methods (PSG)
<i>Riku Mattila, MScTech (2003)</i>	<i>VTT</i>	<i>Reactor physics, advanced nodal methods (AFEN, ARES)</i>
Jaakko Miettinen, MScTech	VTT	Reactor dynamics, development of the coupled TRAB-3D/SMABRE code
Maria Pusa, student (since 2005)	VTT	Reactor physics, uncertainty and sensitivity analysis methods
Markku Rajamäki, DTech	VTT	Reactor dynamics, development, testing and application of CFDPLIM
Anssu Ranta-aho, MScTech	VTT	Reactor physics, criticality safety, isotope concentrations, nodal methods
Hanna Rätty, MScTech	VTT	Reactor dynamics, development and validation of dynamics codes, AER connections
Malla Seppälä, student (since 2005)	VTT	Reactor dynamics, TRAB-3D calculations
Elina Syrjälahti, MScTech (leave of absence 8/2005–2006)	VTT	Reactor dynamics, thermal hydraulics modelling, dynamics benchmarks, uncertainty and sensitivity analysis methods
Timo Vanttola, DTech (during 2003–2004)	VTT	Reactor dynamics, special questions on thermal hydraulics
Frej Wasastjerna, LicTech	VTT	Reactor physics, MCNP (Monte Carlo calculations)

High Burnup Updates in Fuel Behaviour Modelling (KORU) Polttoaineen korkeapalammallinnuksen uudistaminen

Research organisation: VTT

Project manager: Seppo Kelppe, VTT

Deputy project manager: Jan-Olof Stengård, VTT

Person	Org.	Task
Seppo Kelppe, MScTech	VTT	Project Manager; fuel behaviour, codes and applications
Arttu, Knuutila, MScTech	VTT	Mechanical modelling, materials; SCANAIR code
Jan-Olof Stengård, assistant research scientist	VTT	FRAPTRAN development and applications
Laura Kekkonen, MScTech (in Halden since 2006)	VTT	Fuel steady-state modelling; ENIGMA code
Jaakko Miettinen, LicTech	VTT	GENFLO code development and applications
Jukka Rintala, research trainee (since 2005)	VTT	Part-time trainee; probabilistic transient models
<i>Maiju Seppälä, research trainee (2003–2004)</i>	<i>VTT</i>	<i>Part-time trainee</i>
Kari Pietarinen, MScTech since Sept. 2005	VTT	Code applications; thermal hydraulics

Integrity and life time of reactor circuits (INTEL) Reaktoripiirin eheys ja käyttöikä

Research organisations: VTT

Project manager: Pentti Kauppinen, VTT

Deputy project manager: Heikki Keinänen, Arja Saarenheimo, Pertti Aaltonen VTT

Person	Org.	Task
INSEL		
Heikki Keinänen, MScTech	VTT	INSEL sub-project manager
Matti Valo, MScTech	VTT	Research on ageing mechanisms
Kim Wallin, DTech	VTT	Modeling of ageing
Anssi Laukkanen, MScTech	VTT	Transfer of test results for structural analysis
Pekka Nevasmaa, DTech	VTT	Applicability of small specimen test results
Tapio Planman, MScTech	VTT	Ageing mechanisms
Pertti Aaltonen, MScTech	VTT	Integrity of bimetal welds
Ulla Ehrnsten, MscTech	VTT	Integrity of bimetal welds
Toni Hakkarainen, technician	VTT	Ultrasonic TOFD-technique
Jorma Pitkänen, LicTech	VTT	Ultrasonic analysis techniques
Tom Seren	VTT	Dosimetry
Lena Hansson-Lyyra	VTT	Halden research on fuel capsule corrosion

Wade Karlsen (since 2005)	VTT	Research on ageing of materials
Sami Saarela (since 2005)	VTT	Research on ageing of materials
INPUT		
Arja Saarenheimo, LicTech	VTT	INPUT sub-project manager
Matti Sarkimo, LicTech	VTT	Ultrasonic simulation
<i>Marko Api, technician (2003–2004)</i>	<i>VTT</i>	<i>Ultrasonic simulation</i>
<i>Kaisa Simola, DTech (2003–2004)</i>	<i>VTT</i>	<i>Risk informed approach to ISI</i>
Otso Cronvall, MScTech	VTT	Risk informed approach to ISI
Kim Calonius, MScTech (2003–2004)	VTT	Numerical analysis
Jari Tuunanen, DTech (2003)	VTT	Fluid-structure interaction analysis
Juha Poikola, MScTech (2003)	VTT	Fluid-structure interaction analysis
Jarto Niemi, MScTech (2004–2006)	VTT	Fluid-structure interaction analysis
Timo Narumo, DTech (2004)	VTT	Fluid-structure interaction analysis
Mikko Ilvonen, MScTech (2005–2006)	VTT	Fluid-structure interaction analysis
Heikki Pokela, MScTech (2005)	VTT	Fluid-structure interaction analysis
Timo Pättikangas, DTech	VTT	Fluid-structure interaction analysis
Petri Kinnunen, DTech	VTT	Oxide film growth on stainless steel
<i>Timo Laitinen, DTech (2003–2004)</i>	<i>VTT</i>	<i>Oxide film growth on stainless steel</i>
Timo Saario, DTech	VTT	Water chemistry – corrosion interaction
<i>Kari Mäkelä, DTech (2003–2004)</i>	<i>VTT</i>	<i>Water chemistry – corrosion interaction</i>
Pekka Moilanen, DTech	VTT	Research on hydrodynamics
<i>Martin Bojinov, DTech (2003–2004)</i>	<i>VTT</i>	<i>Oxide film growth on stainless steel</i>
Aki Toivonen, DTech	VTT	Water chemistry – corrosion interaction
<i>Ari Vepsä, MScTech (2004)</i>	<i>VTT</i>	<i>Vibrations</i>
Jouni Alhainen, MScTech (2006)	VTT	Fatigue Modelling
Jussi Solin, MScTech (since 2005)	VTT	Fatigue Modelling
Lehtovuori Viivi, Ph.D. (since 2005)	VTT	Corrosion and Activity Incorporation
Lauri Eerikäinen, MScTech (since 2006)	VTT	Fluid Structure Interaction Analyses
Marketta Mattila, laboratory technician (since 2003)	VTT	Corrosion and Activity Incorporation
Päivi Varis (since 2003)	VTT	Corrosion and Activity Incorporation
INCOM		
Pertti Aaltonen, MSc	VTT	INCOM sub-project manager
<i>Kari Mäkelä, DTech (2003–2004)</i>	<i>VTT</i>	<i>Water chemistry – corrosion interaction</i>
Kari Lahdenperä, LicTech	VTT	NDE of steamgenerator tubing
INPERF		
Kim Wallin, DTech	VTT	Physics modelling of irradiation damages
Matti Valo, MSc	VTT	Damage mechanisms
Pertti Aaltonen, MSc	VTT	Integrity of reactor internals
INCOORD		
Pentti Kauppinen, DTech	VTT	INTELI project manager, coordination of INTELI-research

LWR oxide model for improved understanding of activity build-up and corrosion phenomena (LWROXI) (2004–2006)

Aktii visuuden kerääntymisen ja korroosion mallintaminen LWR-olosuhteissa

Research organisation: VTT, University of Chemical Technology and Metallurgy, Sofia, Bulgaria (UCTM)

Project manager: Petri Kinnunen, VTT (since 2005), Martin Bojinov, VTT (2004)

Deputy project manager: Timo Saario, VTT (since 2005), Petri Kinnunen, VTT (2004)

Person	Org.	Task
Petri Kinnunen, DTech	VTT	Project manager (since 2005), Deputy project manager (2004), electrochemical experiments
Viivi Lehtovuori, PhD	VTT	Electrochemical experiments
Martin Bojinov, PhD	VTT (2004), UCTM (since 2005)	Modelling of surface films, Project manager (2004)
Klas Lundgren, MSc	ALARA	Plant data analysis and evaluation
Timo Saario, DTech	VTT	Deputy project manager (since 2005)

Ageing of the Function of the Containment Building (AGCONT) (2003–2004)

Suojarakennustoinnin ikääntyminen

Research organisation: VTT

Project manager: Kalervo Orantie, VTT

Deputy project manager: Erkki Vesikari, VTT

Person	Org.	Task
Kalervo Orantie, MScTech	VTT	Project manager, Ageing of the function on containment
Erkki Vesikari, MScTech	VTT	Deputy project manager

Participation in the OECD NEA Task Group Concrete Ageing (CONAGE) (2003)

Osallistuminen OECD NEA betonirakenteiden vanhentumistyöryhmän työskentelyyn (2003)

Research organisation: VTT

Project manager: Erkki Vesikari, VTT

Person	Org.	Task
Erkki Vesikari, MScTech	VTT	Project manager, Participation in the OECD NEA Task Group Concrete Ageing (CONAGE)

Safety Management of Concrete Structures in Nuclear Power Plants (CONSAFE) 2005

Ydinvoimaloiden betonirakenteiden turvallisuuden hallinta

Research organisation: VTT Building and Transport

Project manager: Erkki Vesikari, VTT Building and Transport

Deputy project manager: Kalervo Orantie, VTT Building and Transport

Person	Org.	Task
Erkki Vesikari, MScTech	VTT	Project Manager; Participation in the OECD NEA Task Group Concrete Ageing
Kalervo Orantie, MScTech	VTT	Deputy project manager; Audit of the pressure tests in Olkiluoto
Pertti Pitkänen, MScTech	VTT	Audit of the pressure tests in Olkiluoto

Concrete Technological Studies Related to the Construction, Inspection and Repair of the Nuclear Power Plant Structures (CONTECH)

Ydinvoimalarakenteiden rakentamiseen, tarkastamiseen ja korjaamiseen liittyvät betonitekniset tutkimukset

Research organisation: VTT

Project manager: Liisa Salparanta, VTT

Deputy project manager: Erkki Vesikari, VTT

Person	Org.	Task
Liisa Salparanta, MScTech	VTT	Project manager
Erkki Vesikari, Lic Tech	VTT	Research Scientist
Heikki Kukko, Dr Tech	VTT	Research Scientist
Pertti Pitkänen, MSc Tech	VTT	Research Scientist
<i>Hannele Kuosa, MSc Tech (2003–2004)</i>	<i>VTT</i>	<i>Research Scientist</i>
<i>Kyösti Laukkanen, MSc Tech (2003–2004)</i>	<i>VTT</i>	<i>Research Scientist</i>
Pekka Räsänen, MSc Tech (2006)	VTT	Research Scientist

The Integration of Thermal-Hydraulics (CFD) and Structural Analyses (FEA) Computer Codes in Liquid and Solid Mechanics (MULTIPHYSICS) 2003–2004
Termohydrauliikka- ja rakenneanalyysikoodien linkittäminen neste-rakennesysteemissä

Research organisation: FNS, VTT, ENPRIMA

Project manager: Pentti Varpasuo, Fortum Nuclear Services Ltd

Deputy project manager: Timo Toppila, Fortum Nuclear Services Ltd

Person	Org.	Task
Pentti Varpasuo, DTech	FNS	Project manager
Timo Toppila, MScTech	FNS	Deputy project manager
Ville Lestinen, MScTech	FNS	
Timo Pätkikangas, DTech	VTT	
Antti Timperi, MScTech	VTT	
Arja Saarenheimo, MScTech	VTT	
Pekka Iivonen, MScCivEng	ENPRIMA	
Seppo Orivuori, LicTech	ENPRIMA	

Coupled Termohydraulics and Structural Mechanics (MULTIPHYSICS) 2005–2006

Research organisation: FNS, VTT

Project manager: Ville Lestinen, Fortum Nuclear Services Ltd

Contact person in VTT: Arja Saarenheimo, VTT

Person	Org.	Task
Ville Lestinen, MScTech	FNS	Project manager
Timo Toppila, MScTech	FNS	Deputy project manager
Jukka Kähkönen, MScTech	FNS	
Timo Pätkikangas, DTech	VTT	
Antti Timperi, MScTech	VTT	
Markku Hänninen, MScTech	VTT	

The Integral Code for Design Basis Accident Analyses (TIFANY) 2003
Integroitu malli suunnittelun perustana olevien onnettomuuksien laskentaan

Research organisations: Fortum Nuclear Services Ltd and VTT (PRO)
 Project manager: Kai Salminen, Fortum Nuclear Services Ltd

Person	Org.	Task
Kai Salminen, MScTech	FNS	Project manager, APROS development
Petra Lundström, MScTech	FNS	Deputy project manager
Davit Danielyan, MScTech	FNS	APROS development
Erkki Eskola, MScTech	FNS	APROS development
Harri Kontio, MScTech	FNS	APROS development
Eerikki Raiko, MScTech	FNS	APROS development
Ari Silde, MScTech	VTT	APROS development
Markku Hänninen, MScTech	VTT	APROS development
Jukka Ylijoki, MScTech	VTT	APROS development

APROS modelling of containment pressure suppression systems (TIFANY) 2004
Suojarakennuksen paineenalennusjärjestelmien APROS-mallien kehittäminen

Research organisations: Fortum Nuclear Services Ltd and VTT (PRO)
 Project manager: Kai Salminen, Fortum Nuclear Services Ltd
 Deputy project manager: Petra Lundström, Fortum Nuclear Services Ltd

Person	Org.	Task
Kai Salminen, MScTech	FNS	Project manager, APROS development
Petra Lundström, MScTech	FNS	Deputy project manager
Davit Danielyan, MScTech	FNS	APROS development
Tommi Henttonen, trainee	FNS	APROS development
Tomi Routamo, MScTech	FNS	APROS development
Ari Silde, MScTech	VTT	APROS development
Markku Hänninen, MScTech	VTT	APROS development
Juha Poikola, MScTech	VTT	APROS development
Jukka Ylijoki, MScTech	VTT	APROS development

Development of APROS Containment Model (TIFANY) 2005
APROS suojarakennusmallien kehittäminen

Research organisations: Fortum Nuclear Services Ltd and VTT
 Project manager: Mika Harti, Fortum Nuclear Services Ltd (FNS)
 Deputy project manager: Petra Lundström and Timo Toppila, Fortum Nuclear Services Ltd

Person	Org.	Task
Mika Harti, MScTech	FNS	Project manager, APROS development
Tommi Henttonen, student	FNS	APROS development
<i>Petra Lundström, MScTech (until mid-2005)</i>	<i>FNS</i>	<i>Deputy project manager, APROS development</i>
Timo Toppila, MScTech	FNS	Deputy project manager, APROS development
Ari Silde, MScTech	VTT	APROS development
Markku Hänninen, MScTech	VTT	APROS development
Juha Poikolainen, MScTech	VTT	APROS development
Jukka Ylijoki, MScTech	VTT	APROS development

Validation of APROS Containment Model (TIFANY) 2006
APROS suojarakennusmallien kelpoistus

Research organisations: Fortum Nuclear Services Ltd and VTT
 Project manager: Mika Harti, Fortum Nuclear Services Ltd (FNS)
 Deputy project manager: Timo Toppila, Fortum Nuclear Services Ltd

Person	Org.	Task
Mika Harti, MScTech	FNS	Project manager, APROS development
Esa Ahtinen, Student	FNS	APROS development
Timo Toppila, MScTech	FNS	Deputy project manager
Ari Silde, MScTech	VTT	APROS development
Markku Hänninen, MScTech	VTT	APROS development
Juha Poikolainen, MScTech	VTT	APROS development
Jukka Ylijoki, MScTech	VTT	APROS development

Thermal hydraulic analysis of nuclear reactors (THEA)
Termohydrauliikka-analyysit

Research organisation: VTT

Project manager: Ismo Karppinen, VTT (since December 2004), *Minna Tuomainen, VTT (until December 2004)**;

Deputy project manager: Juha Poikolainen, VTT (since 2005), Ismo Karppinen, VTT (until December 2004)

Person	Org.	Task
Seppo Hillberg, MScTech (2006)	VTT	APROS calculations
Heikki Holmström, MScTech	VTT	Follow-up of OECD PSB-VVER and USNRC/CAMP
Risto Huhtanen, MScTech	VTT	CFD calculations (since 2005)
<i>Markku Hänninen, LicTech</i>	<i>VTT</i>	<i>Apros improvments (2003–2004)</i>
Mikko Ilvonen, LicTech	VTT	NEPTUNE code testing, participation to NURESIM (since 2005)
Pasi Inkinen, trainee	VTT	APROS calculations
<i>Jorma Jokiniemi, DrTech</i>	<i>VTT</i>	<i>Participation in OECD/GAMA Writing group for SOAR on Nuclear Aerosols (2003–2004)</i>
Pasi Junninen, MScTech (since 2005)	VTT	APROS calculations
Ismo Karppinen, MScTech	VTT	Project manager (since December 2004, deputy project manager until then), follow-up of OECD/GAMA, OECD/PKL, OECD/ROSA
Jarto Niemi, MScTech	VTT	CFD calculations, model development
Juha Poikolainen, MScTech	VTT	APROS calculations, coordination of Northnet
Eija-Karita Puska, DrTech	VTT	Governing Board of EU/NURESIM (since 2005)
Eveliina Takasuo, MScTech (2005)	VTT	APROS and CFD calculations
<i>Risto Sairanen, DrTech*</i>	<i>VTT</i>	<i>Follow-up of OECD GAMA (in 2003)</i>
<i>Minna Tuomainen, MScTech*</i>	<i>VTT</i>	<i>Project manager (2003–2004), follow-up of OECD GAMA (in 2004) and OECD PKL</i>

* resigned from VTT

Archiving experiment data (KOETAR)
Koetulosten arkistointi

Research organisation: Lappeenranta University of Technology
 Project manager: Vesa Riikonen, Lappeenranta University of Technology
 Deputy project manager: Markku Puustinen, Lappeenranta University of Technology

Person	Org.	Task
Vesa Riikonen, MScTech	LUT	Project manager, checking and archiving data
Markku Puustinen, MScTech	LUT	Deputy project manager, checking and archiving data

Condensation pool experiments (POOLEX)
Lauhdutusallaskokeet

Research organisation: Lappeenranta University of Technology
 Project manager: Markku Puustinen, Lappeenranta University of Technology
 Deputy project manager: Heikki Puhonen, Lappeenranta University of Technology

Person	Org.	Task
Markku Puustinen, MScTech	LUT	Project manager, experiment planning and analysis
Heikki Puhonen, LicTech	LUT	Deputy project manager, OECD planning, international tasks, experiments
Jani Laine, MScTech (2003–2006)*	LUT	Experiment analysis, data conversion
Vesa Riikonen, MScTech	LUT	Data acquisition, experiments
Antti Räsänen, MScTech	LUT	Instrumentation, data acquisition, visualization, control systems, experiments
<i>Tomi Nurminen, MScTech (2003)*</i>		<i>Experiment analysis, data conversion</i>
Arto Ylönen, student (since 2006)		Experiment planning and analysis
Harri Partanen, engineer	LUT	Designing of test facilities, experiments
Hannu Pylkkö, technician	LUT	Construction, operation and maintenance of test facilities, experiments
Ilkka Saure, technician	LUT	Construction, operation and maintenance of test facilities, experiments
<i>Juha Kurki, technician (2003–2004)</i>	<i>LUT</i>	<i>Construction, operation and maintenance of test facility, experiments</i>

* resigned from LUT

PACTEL OECD project planning (PACO) (2004)
PACTEL OECD projektin suunnittelu (2004)

Research organisation: Lappeenranta University of Technology
 Project manager: Heikki Purhonen, Lappeenranta University of Technology
 Deputy project manager: Markku Puustinen, Lappeenranta University of Technology

Person	Org.	Task
Heikki Purhonen, LicTech	LUT	Project manager
Markku Puustinen, MScTech	LUT	Deputy project manager
Virpi Kouhia, MScTech	LUT	Research engineer, APROS analyses

Participation in development of European calculation environment (ECE) (2005–2006)
Osallistuminen eurooppalaisen laskentaympäristön (NURESIM) kehittämiseen (ECE)

Research organisation: Lappeenranta University of Technology
 Project manager: Heikki Purhonen, Lappeenranta University of Technology
 Deputy project manager: Juhani Vihavainen, Lappeenranta University of Technology

Person	Org.	Task
Heikki Purhonen, LicTech	LUT	Project manager
Vesa Riikonen, MScTech	LUT	Data conversion, evaluation of test data
Markku Puustinen, MScTech	LUT	Experiment planning, evaluation of test data Deputy project manager, OECD planning, international tasks, experiments
Vesa Tanskanen, MScTech	LUT	NURESIM: SALOME/NEPTUNE installations, model development
Juhani Vihavainen, LicTech	LUT	NURESIM: management and installations

Wall response to soft impact (WARSI)
Lentokonetörmäykset

Research organisations: VTT, Technical University of Tampere (TUT) and Radiation and Nuclear Safety Authority (STUK)

Project manager: Arja Saarenheimo, VTT

Deputy project manager: Kim Calonius, VTT

Person	Org.	Task
Arja Saarenheimo, LicTech	VTT	Project Manager, Structural analyses
Kim Calonius, MScTech	VTT	Structural analyses
Ari Silde, MScTech	VTT	Fuel dispersion studies
Simo Hostikka, MScTech (since 2005)	VTT	Fuel dispersion simulation
<i>Ari Vepsä, trainee research scientist (2003–2004)</i>	<i>VTT</i>	<i>Structural analyses</i>
<i>Hannu Martikainen, MScTech (2003–2004)</i>		<i>LSDYNA analyses</i>
Ari Kankkunen (since 2005)	HUT	Fuel dispersion measurements
Markku Tuomala, Prof.	TUT	Pre and post calculations for impact tests
<i>Erik Eriksson Student (2003–2004)</i>	<i>TUT</i>	<i>M.Sc thesis on deformable missile</i>
Ari Aalto, LicTech.	TUT	Pre calculations for reinforced concrete target
<i>Jukka Myllymäki, LicTech (2003)</i>	<i>VTT/ STUK</i>	<i>Material properties of reinforced concrete</i>

Impact tests (IMPACT)
Lentokonetörmäyksen kokeellinen simulointi

Research organisations: VTT

Project manager: Ilkka Hakola, VTT (Since 2006), *Tuomo Kärnä, VTT (2003–2005)*

Deputy project manager : Ilkka Hakola, VTT (2005)

Person	Org.	Task
<i>Tuomo Kärnä, DTech(2003–2005)</i>	VTT	<i>Project manager, Experimental apparatus, Models of the impacting objects and the reaction wall, Impact tests, Data analysis</i>
Heikki Haapaniemi, MScTech	Fortum Service	Impact tests, Data analysis
Vesa Harja, technician	Fortum Service	Impact tests, Data analysis
Ilkka Hakola, MScTech	VTT	Project manager (Since 2006), Deputy project manager (2005), Experimental apparatus, Impact tests, Data analysis
Jouni Hietalahti, research engineer	VTT	Experimental apparatus, Impact tests, Reaction wall construction
Juha Juntunen, MScTech	VTT	Experimental apparatus, Impact tests, Data analysis, High-speed photography
Jaakko Johansson, technician	VTT	Experimental apparatus, Impact tests, Pressure accumulator
Juha Kurkela, MScTech	VTT	Impact tests, Data analysis
Erkki Järvinen, MScTech	VTT	Measurements, Impact tests, Data analysis
Matti Halonen, student	VTT	Measurements, Impact tests, Data analysis
Ilkka Linna, research engineer	VTT	Experimental apparatus, Impact tests, Pressure accumulator
Auli Lastunen, MScTech (since 2005)	VTT	Experimental apparatus, Impact tests, Data analysis Documentation
<i>Pekka Laine, MScTech (2003–2004)</i>	VTT	<i>Experimental apparatus</i>
Leo Lapinluoma, technician	VTT	Experimental apparatus, Impact tests, Reaction wall construction
<i>Ari Lehtonen, technician (2003–2004)</i>	VTT	<i>Reaction wall construction</i>
Heikki Lintunen, research engineer (2003–2006)	VTT	Reaction wall construction
Jukka Mäkinen, technician	VTT	Experimental apparatus, Measurements, Impact tests, Data analysis
Lasse Mörönen, LicTech (2003–2006)	VTT	Models of the impacting objects and the reaction wall
Pekka Nurkkala, MScTech (2003–2006)	Fortum Service	Impact tests, Data analysis
Kyösti Ovaska, MScTech	VTT	Experimental apparatus, Impact tests, Pressure
Risto Pitkänen, technician	VTT	Experimental apparatus, Impact tests, Pressure
Veijo Sivonen, technician (since 2005)	VTT	Experimental apparatus, Impact tests, Pressure

Tapio Tähkä, technician (since 2005)	VTT	Experimental apparatus, Impact tests, Pressure
Ilpo Kouhia, MScTech	VTT	Infra red camera
Matti Pajari, DTech (2003–2006)	VTT	Models of the impacting objects and the reaction wall
Ari Silde, MScTech (since 2005)	VTT	Measurements, Impact tests, Spreading of the liquid, Data analysis
Ari Kankkunen, LicTech (since 2005)	TKK	Measurements, Impact tests, Spreading of the liquid, Data Analysis
Petri Pesonen, technician	VTT	Concrete testing
Arto Puranen, technician	VTT	Concrete testing
Pekka Sievänen, technician	VTT	Testing equipments

Severe accidents and nuclear containment integrity (SANCY) (2003–2005) Vakavat reaktorinnettomuudet ja suojarakennuksen kestävyys

Research organisations: VTT

Project manager: Ilona Lindholm, VTT

Deputy project manager: Jari Tuunanen, VTT*

Person	Org.	Task
Ilona Lindholm, MScTech	VTT	Project manager, Uncertainties of severe accident uncertainties, Particle bed coolability/STYX test analyses, OECD/MCCI follow-up
Stefan Holmström, LicTech	VTT	STYX experiments
Pekka H. Pankakoski, MScTech	VTT	STYX experiments
Ensio Hosio, technician	VTT	STYX experiments
Ismo Kokkonen, MscTech (2003–2004)	Fortum NS	Permeability measurements of FeCr
Riitta Zilliacus, MSc	VTT	Seal material irradiation, GEMINI2 thermochemical analyses
Harri Joki, MScTech	VTT	Material testing/irradiated seal material
Tommi Kekki, MSc	VTT	GEMINI2 thermochemical analyses
Kari Ikonen, DTech (2003–2004)	VTT	Mechanical analysis of pressure vessel lower head of OL-1/2
Pekka Kanerva, research trainee	VTT	Development of water ingress model WATING
Jaakko Miettinen, LicTech	VTT	Development of water ingress model WATING
Tuomo Sevón, MScTech	VTT	Steam explosion literature study Core-concrete interaction modelling/CCI-1 test analysis, design of experimental facility

* Resigned from VTT in 2004

Cavity Phenomena and Hydrogen Burns (CAPHORN) (2006)

Research organisations: VTT

Project manager: Ilona Lindholm, VTT

Deputy project manager: Tuomo Sevón, VTT

Person	Org.	Task
Ilona Lindholm, MScTech	VTT	Project manager, HECLA-tests, Particle bed coolability modelling
Stefan Holmström, LicTech	VTT	HECLA experiments
Pekka H. Pankakoski, MScTech	VTT	HECLA experiments
Tuomo Sevón, MScTech	VTT	MELCOR analyses, HECLA test analyses, OECD/MCCI-2 follow-up; CSARP follow-up
Jouko Virta, MScTech	VTT	HECLA experiments
Petri Pesonen, technician	VTT	HECLA experiments
Eveliina Takasuo, MScTech	VTT	Hydrogen combustion calculations with TONUS and Fluent codes
Jaakko Miettinen, LicTech	VTT	Particle bed modeling, WABE code analyses
Tommi Kekki, MSc	VTT	GEMINI2 thermochemical analyses

Management of Fission Product Gases and Aerosols

Fissiotuotekaasujen ja aerosolien hallinta (FIKSU) (2003–2004)

Research organisation: VTT

Project manager: Jorma Jokiniemi, VTT

Deputy project manager: Ari Auvinen, VTT

Person	Org.	Task
Jorma Jokiniemi, PhD	VTT	Project manager
Ari Auvinen, MScTech	VTT	Deputy project manager, Participation in Phebus project
Ulrika Backman, PhD	VTT	Ruthenium experiments
Unto Tapper, PhD	VTT	Electron microscopy
Riitta Zilliacus, MSc	VTT	Chemical analysis
Maija Lipponen, MSc	VTT	Chemical analysis
Tommi Renvall, MScTech	VTT	Radio tracer measurements

Behaviour of fission products in air-atmosphere (FIKA) (2005–2006)
Fissiotuotteiden käyttäytyminen ilma-atmosfäärissä

Research organisation: VTT

Project manager: Ari Auvinen, VTT

Deputy project manager: Jorma Jokiniemi, VTT

Person	Org.	Task
Ari Auvinen, MScTech	VTT	Project manager, Participation in Phebus project, CHIP facility – design and planning
Jorma Jokiniemi, Professor	VTT	Deputy project manager
Ulrika Backman, PhD	VTT	Ruthenium experiments
Tommi Kekki, MScTech	VTT	Radio tracer measurements – ruthenium experiments
Teemu Kärkelä, MScTech	VTT	Ruthenium experiments
Maija Lipponen, MSc	VTT	Chemical analysis – ruthenium experiment
Jussi Lyyränen, MScTech	VTT	CHIP facility – experimental work
Jouni Pyykönen, PhD	VTT	CHIP facility – modeling
Unto Tapper, PhD	VTT	Electron microscopy – ruthenium experiments, Artist aerosol analysis
Riitta Zilliacus, MSc	VTT	Ruthenium experiments
Tapani Raunio, MSc student	VTT	Resuspension experiments

Development of Aerosol Models to Nuclear Applications
Aerosolimallien kehittäminen ydinvoimasovelluksiin (AMY):

Research organisation: Fortum Nuclear Services Ltd., VTT

Project manager: Tomi Routamo, Fortum Nuclear Services Ltd.

Person	Org.	Task
Tomi Routamo, MScTech	FNS	Project manager, source term model implementation, SaTu system development
Satu Siltanen, MScTech	FNS	SaTu system development
Ville Karttunen, student	FNS	APROS SA fission product model development
Jorma Jokiniemi, PhD	VTT	Resuspension model development
Ari Auvinen, MScTech	VTT	Resuspension experiments and model development

Emergency preparedness supporting studies (OTUS)
Onnettomuusvalmiuden tukiselvitykset

Research organisation: VTT
Project manager: Jukka Rossi, VTT

Person	Org.	Task
Jukka Rossi, MScTech	VTT	Project manager, Radiation levels in severe accidents during refuelling and maintenance outage, Literature review of sea breeze

Interaction approach to development of control rooms (IDEC)
Valvomoiden käyttäjäkeskeinen kehittäminen

Research organisation: VTT
Project manager: Olli Ventä, VTT
Deputy project manager: Leena Norros, VTT (since 2005)

Person	Org.	Task
Olli Ventä, DTech	VTT	Project manager
Leena Norros, PhD	VTT	Performance evaluation for system usability
Paula Savioja, MScTech	VTT	Interface evaluation for system usability
Jari Laarni, PhD (since 2005)	VTT	Performance and interface evaluation for systems usability
Leena Salo, MscTech (since 2005)	VTT	Interface evaluation, user studies
Maaria Nuutinen, MSc (Psych)	VTT	Method validation

Application Possibilities of Systematic Requirements Management in the Improvement of Nuclear Safety in Finland (APSRem) (2003)
Systemaattisen vaatimustenhallinnan soveltamismahdollisuudet ydinturvallisuuden parantamisessa Suomessa (2003)

Research organisation: RAMSE Consulting Oy
Project manager: Veli Taskinen

Person	Org.	Task
Veli Taskinen	RAMSE	Project manager
Markus Renlund	RAMSE	
Pekka Kähkönen	RAMSE	

Influence of RoHS -directive to reliability of electronics, Prestudy (ROVEL) (2004)
RoHS -direktiivin vaikutus elektronii kan luotettavuuteen, esitutkimus (ROVEL) (2004)

Research organisations: VTT
 Project manager: Hannu Hossi, VTT
 Deputy project manager: Antti Turtola, VTT

Person	Org.	Task
Hannu Hossi, MScTech	VTT	Project manager, Definition of the contents
Antti Turtola, MScTech	VTT	Deputy project manager, Modifications due to EU RoHS -directive.
Helge Palmén, LicTech	VTT	Participation in IEC TC45 standardisation work

Software qualification – error types and error management in software life-cycle (QETES) (2005)
Ohjelmiston kelpoistaminen – ohjelmiston elinkaari, virheentorjuntakeinot ja virhelajit

Research organisations: VTT
 Project manager: Hannu Harju, VTT
 Deputy project manager: Urho Pulkkinen, VTT

Person	Org.	Task
Hannu Harju, LicTech	VTT	Project manager, researcher
Urho Pulkkinen, DTech	VTT	Deputy project manager
Jan Erik Holmberg, DTech	VTT	Researcher
Jukka Ranta, LicTech	VTT	Researcher

Influence of Whiskers to Reliability of Electronics, Prestudy (WHISKE) (2005)
Whiskereiden vaikutus elektronii kan luotettavuuteen, esitutkimus

Research organisations: VTT
 Project manager: Hannu Hossi, VTT
 Deputy project manager: Antti Turtola

Person	Org.	Task
Hannu Hossi, MScTech	VTT	Project manager
Antti Turtola, MScTech	VTT	Deputy project manager
Helge Palmén, MScTech	VTT	

**Organisational culture and management of change (CulMa)
Organisaatiokulttuuri ja muutoksen hallinta ydinvoimalaitoksissa**

Research organisation: VTT

Project manager: Teemu Reiman, VTT

Deputy project manager: Pia Oedewald, VTT

Person	Org.	Task
Teemu Reiman, M.A. Psych.	VTT	Project manager; cultural assessments, development of CAOC methodology, (dissertation work)
Pia Oedewald, M.A. Psych.	VTT	Deputy project manager; case studies concerning management of change and competence of maintenance personnel
Jari Kettunen, M.A.	VTT	Researcher; cases concerning organizing of work at NPPs, outsourcing
<i>Kari Laakso, DTech. (2003–2004)</i>	<i>VTT</i>	<i>Maintenance expert</i>
Reetta Kurtti, cognitive science student	VTT	Research assistant, CULTURE-survey data analysis

**Disseminating Tacit Knowledge in Organizations (DIAMOND) (2004–2006)
TIMANTTI – Tietöpääoman hyödyntäminen organisaatiossa**

Research Organization: Helsinki University of Technology / BIT Research Centre

Project Manager: Niina Rintala, BIT Research Centre

Deputy project manager: Laura Hyttinen, Helsinki University of Technology

Person	Org.	Task
Tanja Kuronen, MScPsych	HUT	Project manager since 1.8.2005, researcher
Katri Säämänen, student of technology	HUT	Research assistant
<i>Niina Rintala, DTech (2003–7/2005)</i>	<i>HUT</i>	<i>Project manager until 31.7.2005, researcher</i>
<i>Laura Hyttinen, LicTech (2003–2004)</i>	<i>HUT</i>	<i>Researcher</i>
Tommi Tikka	HUT	Researcher 1.8.2005–31.12.2005
Eila Järvenpää, DTech, Prof.	HUT	Project leader

Potential of Fire Spread (POTFIS)
Palon leviämisen mahdollisuus

Research organisation: VTT
 Project manager: Olavi Keski-Rahkonen, VTT
 Deputy project manager: Johan Mangs, VTT

Person	Org.	Task
Olavi Keski-Rahkonen, DTech	VTT	Project manager, POTFIS
Johan Mangs, PhD	VTT	Deputy project manager, POTFIS
Simo Hostikka, MScTech	VTT	
Timo Korhonen, DTech (since 2005)	VTT	

Principles and Practices of Risk-Informed Safety Management (PPRISMA)
Riski tietoisien turvallisuudenhallinnan periaatteet ja käytännöt

Research organisation: VTT
 Project manager: Jan-Erik Holmberg, VTT
 Deputy project manager: Urho Pulkkinen, VTT

Person	Org.	Tasks
Kim Björkman, MSc student	VTT	Reliability analysis of long term missions
<i>Pentti Haapanen, MScTech (2003–2004)</i>	<i>VTT</i>	<i>Reliability of computer-based systems</i>
<i>Atte Helminen, MScTech (2003–2005)</i>	<i>VTT</i>	<i>Reliability of computer-based systems</i>
Jan-Erik Holmberg, DTech	VTT	Project manager, risk-informed ways of management of fire situations, risk-informed classification, human reliability, international co-operation
Kristiina Hukki, MA	VTT	Risk-informed ways of management of fire situations
Ilkka Karanta, LicTech (since 2006)	VTT	Reliability of computer-based systems
<i>Mika Koskela, MScTech (2003–2004)</i>	<i>VTT</i>	<i>Reliability of computer-based systems</i>
Kari Laakso, DTech	VTT	Maintenance and operability strategies
<i>Eija Myötyri, MScTech (2003–2004)</i>	<i>VTT</i>	<i>Risk-informed classification, reliability of computer-based systems</i>
Ilkka Männistö, MScTech	VTT	Risk-informed classification, Reliability analysis of long term missions, Maintenance and operability strategies (2006)
Urho Pulkkinen, DTech	VTT	Assistant project manager (since 2004), risk-informed decision making, risk-informed classification, reliability of computer-based systems, international co-operation (2004)
Tony Rosqvist, DTech	VTT	Maintenance and operability strategies
<i>Kaisa Simola, DTech (2003–2004)</i>	<i>VTT</i>	<i>Assistant project manager (2003), risk-informed decision making, international co-operation (2003)</i>
Olli Ventä (2005)	VTT	International co-operation
Björn Wahlström (since 2005)	VTT	Reliability of computer-based systems

Assessment smart device software (ASDES) (2005–2006)
Mikroprosessoriohjattujen laitteiden turvallisuusarviointi

Research organisation: VTT Industrial Systems and Adelard LLP, UK

Project manager: Urho Pulkkinen, VTT Industrial Systems

Deputy project manager: Jan-Erik Holmberg, VTT Industrial Systems

Person	Org.	Task
Urho Pulkkinen, DTech	VTT	Project manager
Jan Erik Holmberg, DTech	VTT	Deputy project manager
Hannu Harju	VTT	
Atte Helminen (2005)	VTT	
Robin E. Bloomfield	Adelard LLP	

Administration and information of the research programme (SAHA)
Tutkimusohjelman hallinto ja tiedotus

Research organisation: VTT

Project manager: Eija Karita Puska, VTT

Deputy project manager: Hanna Rätty, VTT

Person	Org.	Task
Eija Karita Puska, DTech	VTT	Programme leader
Hanna Rätty, MScTech	VTT	Project co-ordinator
Heikki Holmström, MScTech (2003–2004)	VTT	EU FP6 national follow-up (HILJA database)
Timo Vanttola, DTech (2003)	VTT	JSRI-II EU-project (data base)

Author(s) Räty, Hanna & Puska, Eija Karita (eds.)			
Title SAFIR. The Finnish Research Programme on Nuclear Power Plant Safety 2003–2006 Final Report			
Abstract Major part of Finnish public research on nuclear power plant safety during the years 2003–2006 has been carried out in the SAFIR programme. The programme has been administrated by the steering group that was nominated by the Ministry of Trade and Industry (KTM). The steering group of SAFIR has consisted of representatives from Radiation and Nuclear Safety Authority (STUK), Ministry of Trade and Industry (KTM), Technical Research Centre of Finland (VTT), Teollisuuden Voima Oy (TVO), Fortum Power and Heat Oy, Fortum Nuclear Services Oy (Fortum), Finnish Funding Agency for Technology and Innovation (Tekes), Helsinki University of Technology and Lappeenranta University of Technology. The key research areas of SAFIR have been 1) reactor fuel and core, 2) reactor circuit and structural safety, 3) containment and process safety functions, that was divided in 2005 into 3a) thermal hydraulics and 3b) severe accidents, 4) automation, control room and IT, 5) organisations and safety management and 6) risk-informed safety management. The research programme has included annually from 20 up to 24 research projects, whose volume has varied from a few person months to several person years. The total volume of the programme during the four year period 2003–2006 is 19.7 million euros and 148 person years. The research in the programme has been carried out primarily by the Technical Research Centre of Finland (VTT). Other research units responsible for the projects include Lappeenranta University of Technology, Fortum Nuclear Services Oy, Helsinki University of Technology and RAMSE Consulting Oy. In addition, there have been a few minor subcontractors in some projects. The programme management structure has consisted of the steering group, a reference group in each of the seven research areas and a number of ad hoc groups in the various research areas. This report gives a summary of the results of the SAFIR programme for the period January 2003 – November 2006.			
Keywords nuclear safety, reactor components, reactor core, fuel elements, high-burnup, thermal hydraulics, severe accidents, containment, reactor circuit, structural safety, control rooms, automation, organisations, risk informed safety management, ageing, reactor analysis			
ISBN 951-38-6886-9 (soft back ed.) 951-38-6887-7 (URL: http://www.vtt.fi/publications/index.jsp)			
Series title and ISSN VTT Tiedotteita – Research Notes 1235-0605 (soft back ed.) 1455-0865 (URL: http://www.vtt.fi/publications/index.jsp)			Project number 6526
Date December 2006	Language English	Pages 379 p. + app. 98 p.	Price J
Name of project SAFIR		Commissioned by State Nuclear Waste Management Fund (VYR)	
Contact VTT Technical Research Centre of Finland Lämpömiehenkuja 3 A, P.O. Box 1000 FI-02044 VTT, Finland Phone internat. + 358 20 722 111 Fax + 358 20 722 5000		Sold by VTT Technical Research Centre of Finland P.O.Box 1000 FI-02044 VTT, Finland Phone internat. +358 20 722 4404 Fax +358 20 722 4374	

SAFIR, The Finnish Research Programme on Nuclear Power Plant Safety 2003- 2006 has been administrated by the steering group that was nominated by the Ministry of Trade and Industry (KTM). The steering group of SAFIR has consisted of representatives from Radiation and Nuclear Safety Authority (STUK), Ministry of Trade and Industry (KTM), Technical Research Centre of Finland (VTT), Teollisuuden Voima Oy (TVO), Fortum Power and Heat Oy, Fortum Nuclear Services Oy (Fortum), Finnish Funding Agency for Technology and Innovation (Tekes), Helsinki University of Technology and Lappeenranta University of Technology.

The key research areas of SAFIR have been 1) reactor fuel and core, 2) reactor circuit and structural safety, 3a) thermal hydraulics, 3b) severe accidents, 4) automation, control room and IT, 5) organisations and safety management and 6) risk-informed safety management. The research programme has included annually from 20 up to 24 research projects, whose volume has varied from a few person months to several person years. The research has been carried out primarily by Technical Research Centre of Finland (VTT). Other research units responsible for the projects have been Lappeenranta University of Technology, Fortum Nuclear Services Oy, Helsinki University of Technology and RAMSE Consulting Oy.

The deliverables of the programme include 545 publications, 6 Doctoral degrees, 1 Licentiate degree and 17 Master's degrees. The total volume of the programme during the four year period 2003- 2006 has been 19.7 million euros and 148 person years.

Tätä julkaisua myy	Denna publikation säljs av	This publication is available from
VTT PL 1000 02044 VTT Puh. 020 722 4404 Faksi 020 722 4374	VTT PB 1000 02044 VTT Tel. 020 722 4404 Fax 020 722 4374	VTT P.O. Box 1000 FI-02044 VTT, Finland Phone internat. + 358 20 722 4404 Fax + 358 20 722 4374