

Simo Hostikka, Timo Korhonen,
Tuomas Paloposki, Tuomo Rinne,
Katri Matikainen & Simo Heliövaara

Development and validation of FDS+Evac for evacuation simulations

| Project summary report

Development and validation of FDS+Evac for evacuation simulations

Project summary report

Simo Hostikka, Timo Korhonen, Tuomas Paloposki & Tuomo Rinne
VTT Technical Research Centre of Finland

Katri Matikainen
University of Helsinki

Simo Heliövaara
Helsinki University of Technology



ISBN 978-951-38-6981-6 (soft back ed.)

ISSN 1235-0605 (soft back ed.)

ISBN 978-951-38-6982-3 (URL: <http://www.vtt.fi/publications/index.jsp>)

ISSN 1455-0865 (URL: <http://www.vtt.fi/publications/index.jsp>)

Copyright © VTT 2007

JULKAISIJA – UTGIVARE – PUBLISHER

VTT, Vuorimiehentie 3, PL 1000, 02044 VTT

puh. vaihde 020 722 111, faksi 020 722 4374

VTT, Bergsmansvägen 3, PB 1000, 02044 VTT

tel. växel 020 722 111, fax 020 722 4374

VTT Technical Research Centre of Finland, Vuorimiehentie 3, P.O.Box 1000, FI-02044 VTT, Finland

phone internat. +358 20 722 111, fax +358 20 722 4374

VTT, Kemistintie 3, PL 1000, 02044 VTT

puh. vaihde 020 722 111, faksi 020 722 4815

VTT, Kemistvägen 3, PB 1000, 02044 VTT

tel. växel 020 722 111, fax 020 722 4815

VTT Technical Research Centre of Finland, Kemistintie 3, P.O. Box 1000, FI-02044 VTT, Finland

phone internat. +358 20 722 111, fax +358 20 722 4815

Technical editing Anni Repo

Editia Prima Oy, Helsinki 2007

Hostikka, Simo, Korhonen, Timo, Paloposki, Tuomas, Rinne, Tuomo, Matikainen, Katri & Heliövaara, Simo. Development and validation of FDS+Evac for evacuation simulations. Project summary report. Espoo 2007. VTT Tiedotteita – Research Notes 2421. 64 p.

Keywords evacuation simulation, modelling, evacuation experiments, RFID, surveillance cameras

Abstract

The performance based design of fire safety relies strongly on the use of computer simulations of fire and evacuation processes. Due to the increased size and complexity of the new buildings, the evacuation simulations must be able to consider the effects of the large and high density crowds on the movement and the decision making processes associated with the premovement time and exit route selection.

In this work, a new evacuation simulation tool has been developed with three main features: i) The tool can be used to simulate large and high density crowds, where the movement dynamics is affected by the crowd pressure. ii) The interaction between the evacuees and fire can be taken into account by simultaneous simulation, thus allowing a full coupling between the fire conditions and the human behaviour. iii) The decision making processes of the evacuees are modelled taking into account the socio-psychological aspects like the importance of familiar people (group dynamics) and places. The simulation tool has been implemented to the Fire Dynamics Simulator (FDS) software, and called FDS+Evac.

The validation of the new simulation tools requires experimental information on the human behaviour during the evacuation situations – not just the flow rates of the various evacuation routes, but also on the decision making processes during the evacuation. In this work, two different types of evacuation situations were studied. The first type was evacuation drills which are normally carried out as part of the safety training of the staff in public buildings and workplaces. In evacuation drills, careful preparation of the observations is possible. The second type was actual evacuations which occur every now and then. The advantage of actual evacuations is that the decision making processes are likely to be similar to what they would be in case of a real fire.

The main techniques used for the observation of evacuation drills were video cameras and Radio Frequency Identification (RFID). A large amount of information was obtained and the problems in the application of the observation techniques were identified. In the observation of an actual evacuation of a large shopping centre, the recordings of the surveillance cameras were used to measure the flow rates of people. The results are very promising and indicate that the collection of surveillance camera recordings from large evacuations should be started.

Preface

The reported work was conducted in the project “Improvement of the evacuation safety of the large buildings by combining the simulation of fire and human behaviour” within the technology programme on modelling and simulation (MASI) of Tekes – the Finnish Funding Agency for Technology and Innovation. The research project was funded by Tekes, the Finnish Fire Protection Fund, the Ministry of the Environment, the Academy of Finland and VTT. In addition to the funding and research organizations, the project steering group had members from the following companies and organizations: Länsi-Uudenmaan pelastuslaitos, Delta-Marin, Aker Finyards Inc. and SOK Yritysturvallisuus.

The support from the safety organizations of the institutions was essential for the successful implementation of the evacuation experiments, and greatly acknowledged. The contribution of Invisian Oy during the library evacuation is also acknowledged.

*To the memory of our friend and colleague
Henry L. O. Weckman*

Contents

Abstract.....	3
Preface	4
1. Introduction.....	9
2. Evacuation in social psychology literature	11
2.1 Fire as a hazard.....	11
2.2 Usability of panic as a concept.....	11
2.3 Effect of the familiar people and familiar places	12
2.4 Decision making under stress.....	13
2.5 Social effects	13
2.5.1 Majority effect.....	14
2.5.2 Minority effect	14
3. Modelling of human behaviour in evacuation situations.....	15
3.1 Development framework of FDS+Evac	15
3.2 Human movement	16
3.3 Numerical modelling of the decision making	21
3.3.1 Exit selection.....	21
3.3.2 Groups	22
3.3.3 Other behavioural models	24
4. Evacuation experiments	25
4.1 Development of experimental techniques	25
4.1.1 Video recording.....	25
4.1.2 Radio frequency identification.....	25
4.2 Evacuation from a public library.....	26
4.3 Evacuation from a large office building.....	29
4.4 Evacuation from a medium sized office building.....	33
4.5 Surveillance cameras as a source of evacuation data	34
5. Verification and validation of FDS+Evac	38
5.1 Verification of the human movement algorithm	38
5.1.1 IMO qualitative verification tests.....	38
5.1.2 FED calculation.....	41
5.1.3 Unimpeded walking speed vs. smoke density.....	41
5.2 Verification of the decision making model	42

5.3	Validation of the human movement algorithm by comparison to other simulation programmes	44
5.3.1	Sports hall.....	44
5.3.2	Assembly space.....	46
5.3.3	Open floor office.....	48
5.3.4	Specific flows through doors	51
5.4	Experimental validation of the human movement algorithm.....	52
5.4.1	Flows in corridors	52
5.4.2	Staircase of a large office building.....	54
5.4.3	Evacuation from a public library.....	56
6.	Summary.....	59
7.	Future work.....	60
	References	61

1. Introduction

New public buildings typically integrate many different functions like work places, shops, restaurants and recreational activities under the same roof. The new buildings typically tend to be larger than the old ones. These buildings have become a new type of public ‘living rooms’. At the same time, people spend more and more time outside the work and home, at least partly due the increasing portion of single person households. As a result, the fraction of the time the people spend in buildings with at least hundreds, if not thousands, of other people is increasing. As the risk of hazardous fires may be divided into the two components – probability and possible loss – we see that at least one of the two components is increasing.

Traditionally, the evacuation capacity of the building is designed according to a set of relatively simple design criteria on the required width and length of evacuation routes, as described in the national building codes. These criteria are based mainly on experimental findings and lessons learned from the past hazards. However, it would not be possible to build the large multi-purpose centres using the simple design rules. Instead, these places are usually designed using the performance based design method, in which the safety of the design is studied as an entire system, not as fulfilment of individual rules given by the building code.

The performance based design relies much on the numerical modelling and simulation of both the fire and evacuation processes. The increased size and complexity of the buildings make new demands for the techniques used for fire and evacuation simulations. The evacuation simulations must be able to model the dynamics of large and high density crowds. Traditional techniques like those based on the fluid flow analogy or cellular automata can not take into account the effects of the crowd pressure on the movement of an individual. The models must also consider the evacuees’ decision making processes behind the reaction times, premovement times and the exit route selection during the actual evacuation. For an individual person, the escape and evacuation from a building during a fire is always an extraordinary situation. Due to the strong relation to the physical situation of a fire and a tradition to examine the fire safety as a structural issue, the psychological side of the evacuation has not been rigorously studied.

In this work, a new evacuation simulation tool has been developed as a multidisciplinary effort. The movement algorithm is based on the human movement model of Helbing and Molnár [1995] and Helbing *et al.* [2000, 2002] including the modifications by Langston *et al.* [2006]. In the model, humans are treated as individual agents following their own equations of motion. The model allows the simulations of large and high density crowds in horizontal and slanted geometries. To utilize the

current understanding of the socio-psychological effects of the evacuation, a survey of the socio-psychological evacuation literature has been performed. New models have been developed for the decision making processes of the evacuees taking into account some of the socio-psychological aspects like the importance of familiar people (group dynamics) and places. An algorithm for exit selection has been developed to allow more realistic simulations of situations with multiple possible exits and to avoid the sometimes arbitrary allocation of evacuees to the exits. The interaction between the evacuees and fire is also taken into account and the simulation of fire and evacuation processes can be performed simultaneously allowing full coupling from the fire conditions to the human behaviour. The tool allows the modelling of two-way coupling, where the human decisions affect the development of fire. The simulation tool has been implemented to the Fire Dynamics Simulator software (FDS) developed jointly by National Institute of Standards and Technology, VTT and Hughes Associates Inc. [McGrattan *et al.* 2007]. The new simulation tool is called FDS+Evac. The details of FDS+Evac are presented by Korhonen *et al.* [2007] and in the theory and user's guide [Korhonen & Hostikka 2008].

For the reliability of the performance based design, the simulation tools must be validated for the given type of application. The validation of the new simulation tools requires experimental information on the human behaviour during the evacuation situations – not just the flow rates of the various evacuation routes, but also on the decision making processes of the evacuees. In this work, two different types of evacuation situations were studied. The first type was evacuation drills which are normally carried out as part of the safety training of the staff in public buildings and workplaces. In evacuation drills, careful preparation of the observations is possible. The second type was actual evacuations which occur every now and then. The advantage of actual evacuations is that the decision making processes are likely to be similar to what they would be in case of a real fire. The main techniques used for the observation of evacuation drills were video cameras and Radio Frequency Identification (RFID). Detailed description of the experiments is given in a separate report [Hostikka *et al.* 2007].

2. Evacuation in social psychology literature

2.1 Fire as a hazard

Fire has been an essential part of our physical environment since the early stages of human civilization. However, most of the accidental fires have been treated as technical design problems. The psychological and social aspects of fires have got attention only since early 1980's [Canter 1980]. The risk of being killed by a fire is not evenly distributed in the society. According to Marchant [1980, p. 299], the less conscious or less intelligent people in a non-familiar building have a higher risk of being killed than intelligent people in a familiar building.

The confinement of fire deaths is one of the primary goals in practically all regulatory documents concerning the fire safety [Tillander *et al.* 2005]. In Europe, Finland has one of the highest rates of fire deaths with about 20 fire deaths per one million inhabitants per year. The yearly total is thus 90 fire deaths in average with a standard deviation of 9. The corresponding numbers in Austria and Switzerland are 9 and 4, respectively. According to The Finnish National Rescue Association (SPEK), 118 people died in fires in 2006, 93 male, 22 female and three unknowns.

The severity of a fire hazard can be studied by using the concept of catastrophe. Quarantelli [1985] has claimed that the catastrophe is best to define as a consensus-type crisis where the ratio of requirements and resources is in imbalance. The use of the requirement/resources-ratio as a severity measure has the following advantages: Firstly, it reduces the importance of purely physical aspects in the analysis. Secondly, it underlines the collective nature of the catastrophe, the factor promoting the co-operation in the prevention of a catastrophe within the society.

Different catastrophes have many common features like the need for the risk and resource assessment within the society. The common features of the catastrophes enable the planning for emergency situations at the general level. However, the common assumption that information and warning of the approaching hazard make people to perform rational measures of precaution, is wrong because the warnings are often neglected [Dyregrov 1994]. People decide not to evacuate until there are clear sign of danger.

2.2 Usability of panic as a concept

According to the classical definition by Fritz and Marks [1954], the panic is caused by two factors. First, people assume they are in immediate danger to life and secondly, they assume that their possibilities to escape the danger are rapidly weakening. More recent

but somewhat inaccurate definition by Mawson [1980] describes the panic as an escape behaviour that is inappropriate or extremely strong by nature.

The concept of panic is sometimes used by media when it reports the behaviour of the people in the escape situations. It is also used by people to describe the anticipated behaviour of their own or others in a fire situation. The panic behaviour is assumed to be non-rational because it appears as non-desirable, for example blocking the exit routes or leaving the family members behind [Sime 1980].

Several researchers have concluded that panic rarely appears in fire situations [Keating 1985, Bryan 1995, Pauls 1995, Raphael 2005]. The possible wrong decisions during the escape process are usually caused by incomplete information, not panic. An external observer may interpret these wrong decisions as a non-rational behaviour, i.e. panic. These studies prove that the concept of panic is useless for scientific purposes aiming at quantitative behaviour of human behaviour. This in turn provides justification for the modelling of the decision making processes from the rational basis using the theories of game theory and optimization. They also demonstrate that the casualties of fires are not caused by panic, but inappropriate design or use of the facility, like the disuse of auxiliary exit routes.

2.3 Effect of the familiar people and familiar places

The social context of the people should be taken into account when modelling their behaviour. Even under the threat of life, people tend to behave as a group to cope with the difficulties [Gwynne *et al.* 2006]. The social nature of the reaction to a fire has also been emphasized by Pauls [1995, p. 265]. Therefore, a crowd consisting of non-interacting individuals is an unrealistic assumption made by too many emergency evacuation models. As stated by Pan [2006]: “People who come together to a gathering tend to move in concert with each other, orient their actions to each other, and to leave together.” This means that actions taken by two members of a same group are not independent. Pan states that this grouping has the following practical consequences:

1. Exit flow is smoother in a building geometry where the groups can move as a whole, instead of departing or stringing out.
2. A separated group may try to gather together before exiting.
3. Groups that are hierarchically organized, like parents and children, will probably behave differently than those that are not.

When building an evacuation model, the above mentioned characteristics should be considered. Instead of immediately running to the exits, evacuees gather together with familiar people and try to exit together. The group may be tied together for instance by family ties, friendship or work. The strongest group of familiar people is a family consisting of parents and children.

Evacuees usually prefer to escape through the same door they came in [Pan 2006]. This decision will be made even if it would not be as safe as choosing some other route. The tendency to choose the routes that are used normally is even emphasized in a fire situation because people feel that unknown alternatives will increase the threat [Proulx 1993]. For example, the emergency exits may not be used because there is a risk that the door will lead to an unknown hallway. Therefore, it is important that the evacuation design is not based on the use of emergency exits that are not in every-day use, or that the appearance of the emergency exit is similar to the normal exits as much as possible.

2.4 Decision making under stress

A person, who should decide how to survive from a burning building, performs under stress. Janis and Mann [1977] state that decision making under stressful circumstances has two main differences to everyday decision making: The stakes are much higher and the time is limited. Third difference added to these by Proulx [1993] is the incomplete and exceptional nature of information, based on which the decision should be made.

According to Ozel [2001], the stress caused by limited time is an important factor in fire evacuations because it biases the observations of the environment and makes the received information incomplete. This may cause inability to recognize some available exit routes. On the other hand, stress is sometimes considered necessary as it motivates the activity during the danger.

Proulx [1993] states that evacuees start to experience stress when they receive ambiguous information. The stress does not go away until the evacuee has been safe for quite a while. The stress limits the ability to analyze the information in a versatile way. In fire, for example, an evacuee may not notice the optimal exit route or may ignore some additional information, like exit sign. This further promotes the use of familiar routes for escape.

2.5 Social effects

This section shortly explains some findings from the social psychology literature that can be used to model the human decision making and especially the evacuee's probability to change ones mind during the evacuation. These theories are not yet

applied in FDS+Evac code during the current project. They are explained here to motivate some of the future work.

2.5.1 Majority effect

In the classical test of Asch [1955], three out of four “naive” participants gave at least one wrong answer following the example of false participants when visually estimating the lengths of line segments. Another inspection of the same data revealed that for more than 37% of all real participants, the answers were biased towards the answers of the false participants. According to Asch, this result demonstrates the evident wish to follow the majority.

Large majorities have generally stronger social effect than smaller [Latané 1981]. However, if scaled by the size of the majority, the strength goes down when the group size increases.

The theory of majority effect can be used to model the probability that an evacuee conforms to the majority when choosing an exit route during the evacuation. If the majority of the evacuees have made a different decision on exit route, an individual may feel pressure to follow the majority.

2.5.2 Minority effect

Minorities may affect the decisions made by the majority if the minority behaves consistently and logically, and if the minority viewpoints are clearly defined. In their experimental work, Moscovici *et al.* [1969] found out that if the minority behaved consistently, almost 10% of the test answers followed the minority opinion, while the number was only 0.25% in a control group. This result gives minorities hope of their influence.

While the majorities mainly cause conformability, the minorities may actually trigger revisions of the personal opinions. In evacuation situation, a determined minority may encourage somebody to give up the current exit route and follow the minority.

3. Modelling of human behaviour in evacuation situations

3.1 Development framework of FDS+Evac

Since the release of its first version, Fire Dynamics Simulator (FDS) has been used by an increasing group of engineering companies, researchers, fire authorities and educational institutes to simulate the behaviour of fires. FDS was originally developed at the National Institute of Standards and Technology (NIST), USA. The popularity of FDS is based mainly on three features:

1. As a CFD-code, it is technically more advanced than most of the previous codes based on the simple two-zone modelling. The use of LES-based modelling of turbulence and fast flow solvers provide some advantages over the other existing CFD codes available for fire simulation.
2. FDS is accompanied by Smokeview program, a powerful and user-friendly tool for the post processing the results. Also, the simple format of the input data makes the learning curve of the code usage very steep.
3. FDS is freely available, both as a source code and as pre-compiled executables.

VTT has participated in the FDS development in close co-operation with NIST since the year 2000. Currently, the FDS is developed jointly by NIST, VTT and Hughes Associates Inc.

Previously, one difficulty associated with the evacuation simulations has been the lack of coupling between the fire and evacuation simulations, although some evacuation software have included simple two-zone type fire models or have accepted results of such models as inputs. The possibility to connect an evacuation simulation to the FDS fire simulation was therefore a natural direction of extending the FDS capabilities.

The possibility to implement an agent-based model for humans to FDS came originally from the analogy of human and water droplet. It was concluded that if FDS can keep track of tens or hundreds of thousands of Lagrangian water droplets during the fire simulation including sprinklers, it should be able to simulate the movement of few thousands of people with a tolerable computational cost. The complexity of the human-human interactions, and the resulting amount of computations were found out only afterwards, as it became evident that an evacuation simulation of big crowd is going to cost roughly as much as the fire simulations. However, usually such a cost can be considered acceptable due to the importance of the evacuation process.

Since the version 5 of FDS, the program development and maintenance has utilized a version control system (SVN). The source code is maintained at a public domain server¹, and each member of the developer team can commit changes and updates to the code. The evacuation specific parts of the source code are indeed included in the FDS source code and all the features of the FDS+Evac are thus available in the main FDS. Only the documentation and user support of the FDS+Evac are administered by VTT. The home page for FDS+Evac can be found at <http://www.vtt.fi/fdsevac>.

3.2 Human movement

Simultaneous egress of large crowds may cause life-threatening situations. When the crowd faces a bottleneck that slows down the movement of the first pedestrians, while the rest of the crowd keeps on pushing forward, the situation may lead to clogging at the bottleneck. Light pushing or leaning forward by crowd members in the back can create bone-breaking pressure in the front. Some evacuees may also fall down and complicate the evacuation of the others. The ability to identify the situations in which hazardous clogging may occur is one of the main tasks a good egress simulation model should have.

In order to realistically simulate the clogging phenomenon, the simulation model should include the real physical forces appearing in such situations. These forces include ‘body forces’ that counteract body compression and friction forces between two pedestrians and between pedestrians and walls. Including these forces requires modelling evacuation as a many-particle system in continuous space.

In FDS+Evac, each human is followed by an equation of motion. This approach allows each human to have her/his own personal properties and escape strategies, i.e., persons are treated as autonomous agents. The model behind the movement algorithm is the social force model introduced by Helbing and Molnár [1995] and Helbing *et al.* [2000, 2002] and modified by Langston *et al.* [2006] to include a better description of the shape of the human body and to include the rotational degrees of freedom.

The PANIC model of Helbing has been implemented and used to calculate the movement of the agents. Each agent follows its own equation of motion:

$$m_i \frac{d^2 \mathbf{x}_i(t)}{dt^2} = \mathbf{f}_i(t) + \boldsymbol{\xi}_i(t), \quad (1)$$

where $\mathbf{x}_i(t)$ is the position of the agent i at time t , $\mathbf{f}_i(t)$ is the force exerted on the agent by its surroundings, m_i is the mass, and the last term, $\boldsymbol{\xi}_i(t)$, is a small random fluctuation

¹ The server is hosted by Google Code (<http://code.google.com/p/fds-smv/>).

force. The velocity of the agent, $\mathbf{v}_i(t)$, is given by $d\mathbf{x}_i/dt$. The force on the agent has many components:

$$\mathbf{f}_i = \frac{m_i}{\tau_i} (\mathbf{v}_i^0 - \mathbf{v}_i) + \sum_{j \neq i} (\mathbf{f}_{ij}^{soc} + \mathbf{f}_{ij}^{att} + \mathbf{f}_{ij}^{ph}) + \sum_b \mathbf{f}_{ib} + \sum_k \mathbf{f}_{ik}^{att}, \quad (2)$$

where \mathbf{f}_{ib} describes the agent–wall interactions, \mathbf{f}_{ik}^{att} some other agent–environment interactions, e.g., fire–agent repulsion. The agent–agent interaction has three parts. For the social force term \mathbf{f}_{ij}^{soc} we have used the anisotropic formula proposed by Helbing *et al.* [2002]

$$\mathbf{f}_{ij}^{soc} = A_i e^{-(r_{ij} - d_{ij})/B_i} \left(\lambda_i + (1 - \lambda_i) \frac{1 + \cos \varphi_{ij}}{2} \right) \mathbf{n}_{ij}, \quad (3)$$

where r_{ij} is the distance between the centres of the circles describing the agents, d_{ij} is the sum of the diameters, and the vector \mathbf{n}_{ij} is the unit vector pointing from j to i . The angle φ_{ij} is the angle between the direction of the motion of the agent feeling the force and the direction to the agent, which is exerting the repulsive force. The parameters A_i and B_i describe the strength and spatial extent of the force, respectively. The parameter λ_i controls the anisotropy of the social force. If $\lambda_i = 1$, then the force is symmetric and if it $0 < \lambda_i < 1$, the force is larger in front of an agent than behind.

The term \mathbf{f}_{ij}^{ph} in Eq. (2) describes the physical contact force between agents and it is given by:

$$\mathbf{f}_{ij}^{ph} = [k(d_{ij} - r_{ij}) + c_d \Delta v_{ij}^n] \mathbf{n}_{ij} + \kappa(d_{ij} - r_{ij}) \Delta v_{ij}^t \mathbf{t}_{ij}, \quad (4)$$

where Δv_{ij}^t and Δv_{ij}^n are the differences of the tangential and normal velocities of the agents in contact, respectively, and vector \mathbf{t}_{ij} is the unit tangential vector of the contacting circles. This force applies only when the agents are in contact, i.e., $d_{ij} - r_{ij} \geq 0$. The radial elastic force strength is given by the force constant k and the strength of the frictional force by the force constant κ . Note, that Eq. (4) contains also a physical damping force [Langston *et al.* 2006] with a damping parameter c_d , which the original model by Helbing and Molnár [1995] and Helbing *et al.* [2000, 2002] does not have. The term \mathbf{f}_{ij}^{att} in Eq. (2) can be used to describe attraction (or repulsion) between humans, like a herding behaviour or adult–children interaction. It could also be used to form pairs of humans, e.g., describing a fire-fighter pair entering the building.

The first term on the right hand side of Eq. (2) describes the self-driving force on the evacuating agent. Each agent tries to walk at its own specific walking speed $|\mathbf{v}_i^0|$ towards an exit or some other target. τ_i is the relaxation time parameter, for which

a value of about 1.0 s is used as a default in FDS+Evac. The trajectory to the exit is given by the direction of the preferred walking velocity v_i^0 field. The novelty of present method lies in the way that this preferred walking direction vector field is obtained using FDS and its flow solver.

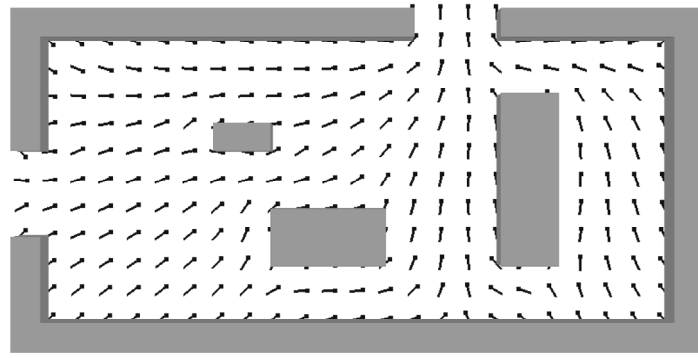

Figure 1. A simple example showing how the flow field is used to guide human movement.

Each agent finds the exit door by following the potential flow solution of a two-dimensional incompressible fluid to the given boundary conditions, i.e., which exits may be used by this agent. The FDS flow solver is used to calculate an approximation to this potential flow field by using large viscosity and low flow speeds, so that there are no vortices in the solution, see Figure 1.

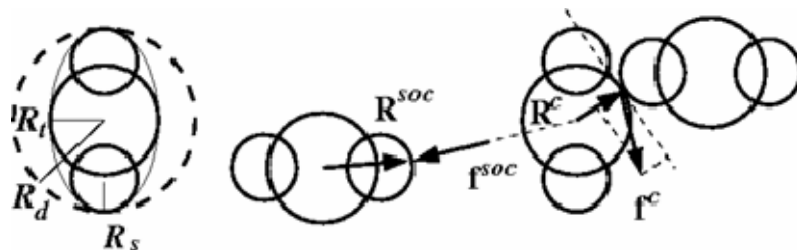

Figure 2. Illustration of the three-circle model of humans.

The presented model was modified by Langston *et al.* [2006] to include the rotational degrees of freedom. In this model humans are modelled with three circles instead of one. The three circles describe the shape of human bodies more realistically than one circle, see Figure 2. The default body dimensions and the unimpeded walking speeds of different predefined human types of FDS5+Evac are listed in Table 1.

Table 1. Unimpeded walking velocities and body dimensions in FDS5+Evac. The offset of shoulder circles is given by $ds = R_d - R_s$, for the definition of the other body size variables, R_d , R_t , R_s , see Figure 2.

Body type	R_d (m)	R_t/R_d	R_s/R_d	d_s/R_d	Speed (m/s)
Adult	0.255±0.035	0.5882	0.3725	0.6275	1.25±0.30
Male	0.270±0.020	0.5926	0.3704	0.6296	1.35±0.20
Female	0.240±0.020	0.5833	0.3750	0.6250	1.15±0.20
Child	0.210±0.015	0.5714	0.3333	0.6667	0.90±0.30
Elderly	0.250±0.020	0.6000	0.3600	0.6400	0.80±0.30

Equations (1)–(4) describe the translational degrees of freedom of the evacuating agents. The rotational degrees of freedom are treated similarly, i.e., each agent has its own rotational equation of motion:

$$I_i^z \frac{d^2 \varphi_i(t)}{dt^2} = M_i^z(t) + \eta_i^z(t), \quad (5)$$

where $\varphi_i(t)$ is the angle of the agent i at time t , I_i^z is the moment of inertia, $\eta_i^z(t)$ is a small random fluctuation torque and $M_i^z(t)$ is the total torque exerted on the agent by its surroundings

$$M_i^z = M_i^c + M_i^{soc} + M_i^\tau \quad (6)$$

The torque of the contact forces is calculated as

$$\mathbf{M}_i^c = \sum_{j \neq i} \mathbf{R}_i^c \times \mathbf{f}_{ij}^c, \quad (7)$$

where \mathbf{R}_i^c is the radial vector which points from the centre of the agent i to the point of contact. In FDS+Evac, also the social forces exert torques on agents and these are given by the formula

$$\mathbf{M}_i^{soc} = \sum_{j \neq i} \mathbf{R}_i^{soc} \times \mathbf{f}_{ij}^{soc}, \quad (8)$$

where only the circles, which are closest to each other, are considered. The vector \mathbf{R}_i^{soc} points from the centre of the agent i to the fictitious contact point of the social force, see Figure 2.

Analogous to the motive force, the first term on the right hand side of Eq. (2), a motive torque is defined as

$$M_i^\tau = \frac{I_i^z}{\tau_i^z} ((\varphi_i(t) - \varphi_i^0) \omega_i^0 - \omega(t)) = \frac{I_i^z}{\tau_i^z} (\tilde{\omega}_i^0(t) - \omega(t)), \quad (9)$$

where ω_i^0 is the maximum target angular speed of a turning agent, $\omega(t)$ the current angular velocity, $\varphi_i(t)$ the current body angle, and φ_i^0 is the target angle where vector \mathbf{v}_i^0 is pointing. The target angular speed $\tilde{\omega}_i^0$ is larger when the body angle differs much from the desired movement direction. Langston *et al.* [2006] used a different formula for the motive torque, which had a form of a spring force. During this work, it was noticed that a force like that will make agents to rotate around their axis like harmonic oscillators, and thus, some angular velocity dependent torque should be used.

By using FDS as the platform of the evacuation calculation we have direct and easy access to all local fire related properties, like gas temperature, smoke and gas densities, and radiation levels. Fire influences evacuation conditions; it may incapacitate humans and in extreme cases block major exit routes. On the other hand, humans may influence the fire by opening doors or actuating various fire protection devices. For now, the effect of smoke on the movement speeds of humans and the toxic influence of the smoke are implemented in movement algorithm of FDS+Evac. The exit selection algorithm of the agents uses smoke density to calculate the visibility of the exit doors.

Smoke reduces the walking speed of humans due to the reduced visibility, its irritating and asphyxiant effects. Recently, Frantzich and Nilsson [2003] made experiments on the effect of smoke concentration on the walking speeds of humans. They used larger smoke concentrations than Jin [1978] and they fitted the following formula to the experimental values

$$v_i^0(K_s) = \frac{v_i^0}{\alpha} (\alpha + \beta K_s), \quad (10)$$

where K_s is the extinction coefficient ($[K_s] = \text{m}^{-1}$) and the values of the coefficients α and β are 0.706 ms^{-1} and $-0.057 \text{ m}^2 \text{ s}^{-1}$, respectively.

So far, the interaction between the fire and the humans is one-way only. The toxic effects of gaseous fire products on humans are modelled using Purser's Fractional Effective Dose (FED) concept [Purser 1995]. A person is considered to be incapacitated when the FED value exceeds unity. An incapacitated human is modelled as an agent, who does not experience any social forces from the other agents and whose target movement speed, v_i^0 , is set to zero. The size of an incapacitated agent is not changed, *i.e.*, it remains on its feet. This is a very crude model and it needs to be modified in later versions of FDS+Evac.

The main advantage of Helbing's model is that its equations are based on the actual physical forces arising in crowds. Because of this, the model is able to realistically simulate the clogging effects that are caused by these forces. Simulation of these effects is one of the main tasks of egress simulation, and for this task, Helbing's equations are the best available approach.

Another benefit of the model is the possibility to easily implement different behaviours or actions for the occupants. This can be done by changing the desired moving speed and direction. Thus, an arbitrary behaviour following the basic laws of physics can be modelled by altering these two functions. For example, to model herding, the desired directions can simply be set to point to the other evacuees. The behavioural models presented in this work mostly consider how the values of $\mathbf{v}_i^0(t)$ should be defined in different situations.

3.3 Numerical modelling of the decision making

3.3.1 Exit selection

Game theoretic reaction functions and best response dynamics are applied to model the exit route selection of evacuees. In the model, each evacuee observes the locations and actions of the other evacuees and selects the exit through which the evacuation is estimated to be the fastest. Thus, the exit selection is modelled as an optimisation problem, where each evacuee tries to select the exit that minimises the evacuation time. The estimated evacuation time consists of the estimated time of walking and the estimated time of queuing. The walking time is estimated by dividing the distance to the exit by the walking speed. The estimated time of queuing is a function of the actions and locations of the other evacuees. It is also assumed that people change their course of action only if there is an alternative that is clearly better than the current choice. This behaviour is taken into account by subtracting a parameter from the estimated evacuation time of the exit currently chosen.

Apart from the locations of exits and the actions of other people, there are also other factors that influence the evacuees' decision making. These factors are the conditions related to the fire, the evacuees' familiarity with the exits and the visibility of the exits. The effect of these factors is taken into account by adding constraints to the evacuation time minimisation problem. According to the three factors mentioned, the exits are divided to seven groups so that each exit will belong to one group. The groups are given an order of preference.

The familiarity of each exit for each agent can be determined by user in the input-file of FDS+Evac. It is also possible to give a probability for the familiarity of an exit, and FDS+Evac will randomly set the familiarity of the exit. FDS+Evac determines the visibility of an exit to an agent by taking into account the blocking effect of smoke and obstacles. The possible blocking effect of other agents is not considered in the current version of the programme. The existence of disturbing conditions is estimated from the fire-related data of FDS on the visible part of the route to the exit. By disturbing conditions we mean conditions, like temperature and smoke that disturb an evacuee but are not lethal. If there are lethal conditions on an exit route, the exit has no preference.

The exit selection algorithm consists of the above described two phases. First the exits are divided to the preference groups according to Table 2. In the cases presented by the last two rows, the exits have no preference because the evacuees are unaware of the exits that are unfamiliar and invisible. Then, an exit is selected from the most preferred nonempty preference group by minimising the estimated evacuation time.

Table 2. Preference order for exits used in the exit selection algorithm.

Preference	Visible	Familiar	Disturbing conditions
1	yes	yes	no
2	no	yes	no
3	yes	no	no
4	yes	yes	yes
5	no	yes	yes
6	yes	no	yes
No preference	no	no	no
No preference	no	no	yes

According to socio-psychological literature [Pan 2006, Proulx 1993] the familiarity of exit routes is an essential factor influencing decision making. This is because the unknown factors related to unknown routes are considered to increase the threat. As a result, evacuees prefer familiar exit routes even if there are faster unfamiliar routes available. For this reason, emergency exits are used rarely in evacuations and fire drills.

3.3.2 Groups

According to socio-psychological literature, a crowd consists of small groups, like families, that tend to act together. This behaviour should be taken into account when building evacuation models. A method for modelling this grouping behaviour with the

equations of Helbing was developed. In the model, the actions of a group are divided into two stages:

1. In the gathering stage the group members walk towards each other to gather the group.
2. In the egress stage the group moves together along the selected exit route.

These two stages are modelled by altering the preferred walking direction field of Helbing's equation of motion. In the gathering stage the pedestrians are trying to move towards the centre of the group. When the distances from the centre to each pedestrian are under a threshold value, the group is considered to be complete. When a group is complete, it starts to move towards an exit. This means that each group member is set to follow the same flow field. While moving towards an exit, the group members also try to keep the group together. This is modelled by adjusting the walking speeds and by adding an additional force pointing to the centre of the group. This force is called as the group force. The magnitude of the group force describes how eagerly the group members try to keep the group together. It can be given different values for different kinds of groups. For example, a group consisting of a mother and a child should have a larger group force than a group of work mates. The group-model is not yet available in FDS5, but it will be added to later versions of the program. The model has been programmed to a test-version and the results are promising, but quantitative effects of the model are yet to be analysed.

An example of the group model behaviour is shown in Figure 3. A crowd of 100 people consists of groups of five and six people. The left-hand figure shows the initial positions of the people. In the middle is a snapshot of the situation a few seconds after the evacuation started. In this figure most of the groups have gathered into their groups. The right-hand figure shows the situation after few more seconds when most of the groups have already started to move towards the exits.

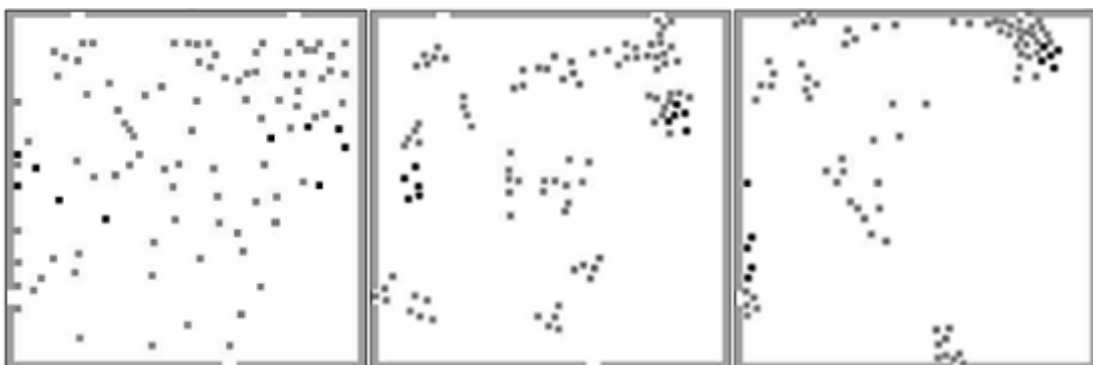

Figure 3. Snapshots of a test simulation with the group model.

3.3.3 Other behavioural models

In addition to the exit selection and group models, also other behavioural models were developed in the project. These models include a method for modelling the amount of stress experienced by evacuees and a stochastic model for the propagation of detection among a crowd. These methods have not yet been tested in any programs, and thus, will not be further discussed in this report. Detailed descriptions of the models are presented in the Masters thesis of Heliövaara [2007].

4. Evacuation experiments

This section gives a short summary of the experimental work. More details can be found in a separate report “Experimental observations of evacuation situations” [Hostikka *et al.* 2007].

4.1 Development of experimental techniques

4.1.1 Video recording

Traditionally, the primary method of making observations in the evacuation experiments has been the use of video cameras. Video imaging may be used for two objectives in evacuation experiments: It may provide a recording of the door or exit flow for later use, or it may provide information on the reaction and pre-movement times, decision making processes and other human behaviour aspects for later analysis.

When used as a recording of an exit flow, a proper technique is needed for counting the humans. The resulting data should contain the cumulative sum of evacuees at sufficient time resolution to enable the computation of flow rates. In this work, the flows were counted manually by using a custom made computer program, *Evaccounter*.

Automatic detection of moving objects in video material is sometimes used in the security and surveillance camera applications. The application of such techniques was studied by contacting companies selling the services of human detection but the results were mostly negative. For a reliable detection, the cameras should be placed directly above the area to be detected which is impossible in field experiments. Also, some of the commercial systems worked only in on-line mode providing no possibility for post-processing.

4.1.2 Radio frequency identification

The need for experimental observations of decision making processes introduces a new challenge for the experimental design and measurements. Quantitative techniques for observing human decisions like the selection of escape routes are not readily available. New techniques that can identify and monitor the location and movement of individuals are thus needed. One such a technique is the Radio Frequency Identification (RFID) that is commonly used for remote identification. In this work, the RFID techniques based on the vicinity and remote (UHF) sensing techniques were used. The tags to observe were passive tags attached to plastic ID badges.

The three tests where RFID techniques were applied showed promising results. Despite the small amount of testees and the uncertainty in the actual number of tags, it is quite evident that the percentage of identified tags will be better than 50% if proper alignment and measurement power of reader antennas is found by thorough experiments. This holds true even in crowded staircases. However, these kinds of demonstrative experiments do not tell much about the reliability of the technique itself, but the applicability of the technique for the given purpose.

Some recommendations for the experimental setups were found: The antennas should be installed in a steep angle facing almost downwards and “uphill” towards the walking or descending persons. The tags should be placed horizontally as high as possible far away from the body of test persons. Tags designed to be used on metallic surfaces should be tested or special tags designed for person identification should be plotted. To avoid the screening effect, the use of more than one antenna on one measurement spot should be considered. When RFID-technique in person identification is becoming more common, the prices of antennas will come down, since they are very simple in construction.

4.2 Evacuation from a public library

The evacuation of the main library of Helsinki University of Technology was carried out as part of the safety training program of the library staff. The staff was informed that the evacuation would take place in the given day. The library visitors were notified on the evacuation exercise by printed notes on the entrance doors. Exact time was not specified, nor were the details of the evacuation. A floor plan and the numbering of the library doors during the evacuation are shown in Figure 4. It was anticipated that most staff members would exit through door 1 and two different RFID techniques were used at door 1. Before the evacuation, a group of 33 people of the library staff were equipped with two different types of RFID tags. Immediately before the evacuation, researchers entered the building to make observations on crowd behaviour and outside the building to observe all doors. Video cameras were used to observe the evacuation from doors 1 and 4.

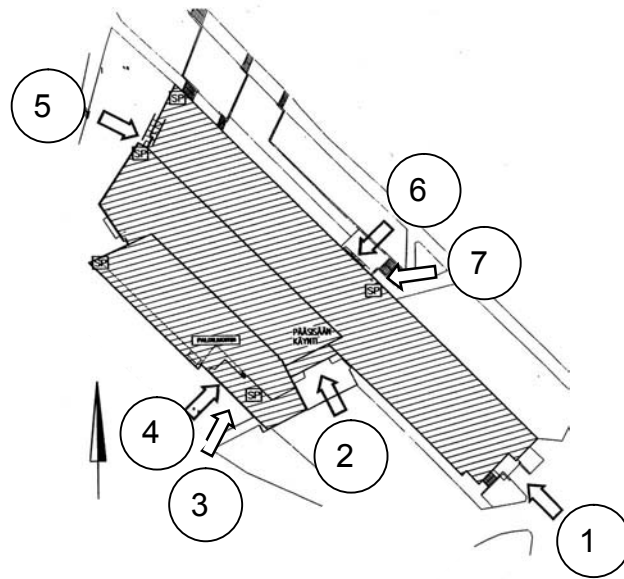

Figure 4. The numbering of the doors for HUT main library.

A smoke generator was put in operation in the lobby, thus preventing the use of doors 2 and 6. A fire alarm went off 37 seconds after the smoke generator was started, and evacuation began. The alarm signal was a loud bell sound. In 5 minutes 52 seconds after the fire alarm, all 189 people that had been in the building had evacuated.

A great majority of people decided to evacuate through the stairway and door number 5, which was in the opposite end of the building to the ‘fire’. The staff members tried to give instructions and distribute people evenly to the two available stairways but many evacuees did not pay much attention to these instructions.

The premovement times of 42 people, i.e. the time from alarm to the actual movement towards an exit, were collected from the videos. The average premovement time was 36 s. The cumulative distribution of these times is shown in Figure 5, accompanied by the LMS-fitted Weibull and LogNormal distributions.

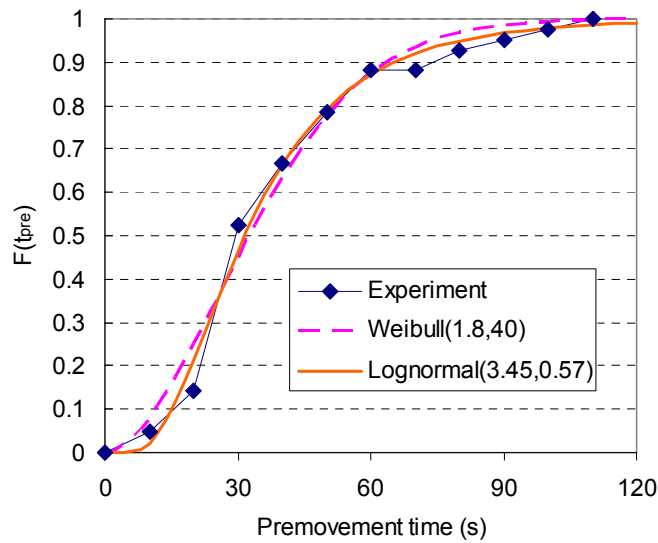

Figure 5. Distribution of observed premovement times ($N = 42$) in the public library and fitted Weibull and LogNormal distributions.

The cumulative number of evacuated people for each door is shown in Figure 6. Most staff members used the door 1 and the most visitors used the door 5. The flow of people out of the door 5 was quite steady from about 70 s to 200 s from the alarm, and probably controlled by the width of the stairway and the doors leading to the stairway. The flow rate was found to be about 0.7 persons per second, which is $0.8 \text{ persons s}^{-1}\text{m}^{-1}$. However, the flow rate is based on the manual bookkeeping, and the uncertainty of the actual flow rate is quite high.

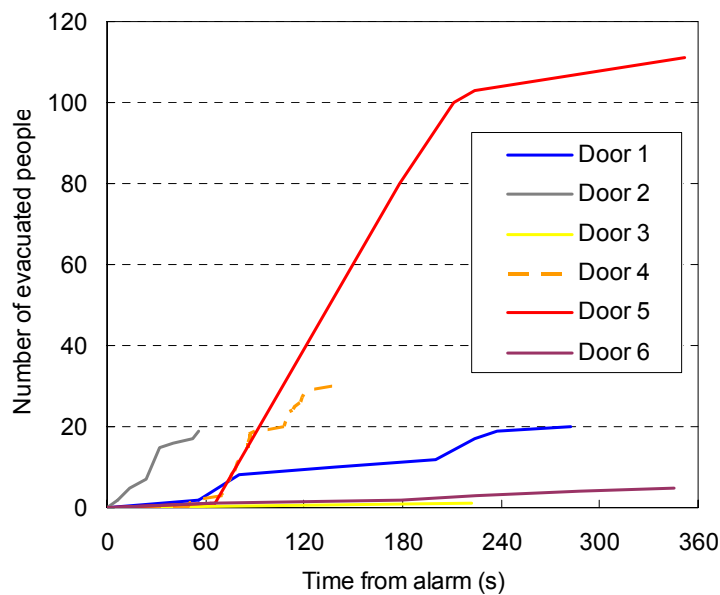

Figure 6. The cumulative number of evacuated people for the doors of public library.

Both inductive and UHF RFID antennas were installed at door 1. A comparison of the video and technical observations revealed that the inductive RFID observed and identified 5 of 12 people and the UHF RFID observed and identified only 3 of 12. The main reason for the low identification percentage was that the tags were placed close to the body or some other electrically conducting object, where the electromagnetic field ceased to exist. Test persons who were identified had the tags on their clothing or otherwise far away from their body.

4.3 Evacuation from a large office building

The second evacuation exercise was carried out in a large office building with 7 floors and 4 entrances from the street level. Normally, there are about 500 employees working in the building. The office building is illustrated in Figure 7, where the entrances are also shown. The door 1 is normally used as a main entrance of the building for staff and visitors etc.

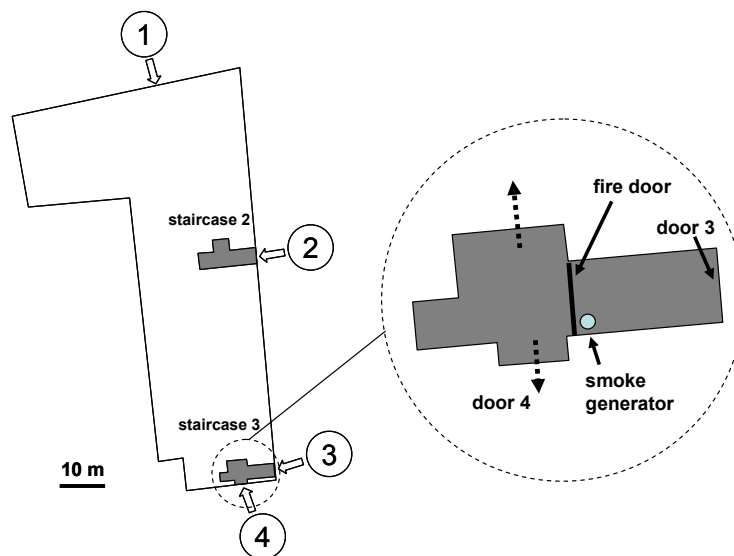

Figure 7. The geometry of large office building showing the 4 entrances. The gray areas present the staircases at the street level and the dashed arrows presents the exit routes from the staircase 3 in our experiment.

Cold smoke generators were placed at the street level inside both the entrances 1 and 3. The smoke generator in staircase 3 located between outer door (door 3) and fire door, so that people could still descend safely from the staircase 3 to the street level behind the fire door and walk inside the building to the door 2 in staircase 2. It was also possible to use door 4 for the evacuation, see Figure 7.

The staircase behind the entrance 2 was equipped with six digital video (DV) cameras and five RFID antennas. For RFID, the FEIG reader with four antennas was assembled

into the staircase. The antennas were placed on the entresol landing facing athwart down towards the descending test persons at a distance of approximately 2–3 meters, as shown in Figure 8. The tags were given to four groups of people. Two of the groups were located in the 6th and two of them in the 5th floor. The other monitoring locations of the office building were outside nearby the exits.



Figure 8. Left side: monitoring equipments between floor levels (RFID-antenna and DV-camera). Right side: snapshot of the DV-camera during the evacuation exercise.

The information that the exercise would occur at the certain day and time was announced to the personnel beforehand. After the smoke generators were turned on, it took about 2 min to the fire alarm, and the evacuation started. The first people came out of the staircase 2 about 1 min after the alarm. Most of the people came out, as it was planned, through staircase 2. At the time 6 min 40 sec from the alarm the local fire brigade arrived close to the main entrance and started the fire attack.

The evacuation through staircase 2 was analyzed using the video material. The evacuees walked calmly and no rushing occurred. Some queuing was observed, because some single people gave room to a flow descending from upper floors. One big queue formed when few people coming upper floors stopped and waited for 60 sec.

The percentage of RFID tags identified during the test was much better than in the public library. Table 3 shows the number of tags delivered and observed in any of the five measurement points. Almost all the tags were observed at least once.

Table 3. Number of tags delivered and identified in the large office building.

Group	Group 1	Group 2	Group 3	Group 4
Tags delivered	23	22	16	20
Tags observed	20	18	13	19
Percentage of identified tags	87.0	81.8	81.3	95.0

When the number of observations on each floor was compared to the total number of observations of a certain group, it was found that the degree of success was close to 60%. In average, 17% of the tags delivered were identified in all measurement points. The variation between the groups may be due to the differences between the briefings before the evacuation rehearsal. Clothing may also have an influence. Metallic zippers in the outerwear are made of electrically conducting material.

The number of evacuated people through staircase 2 is shown in Figure 9. Total number of evacuated people in 6 min period was 281 (Figure 9a). The linear part of the curves shows that the human flow is saturated to a certain level because of the limiting width of the stairs and the front door. Figure 9b shows that the majority of the persons came from the 4th and 1st floors. The flow rates are shown in Table 4.

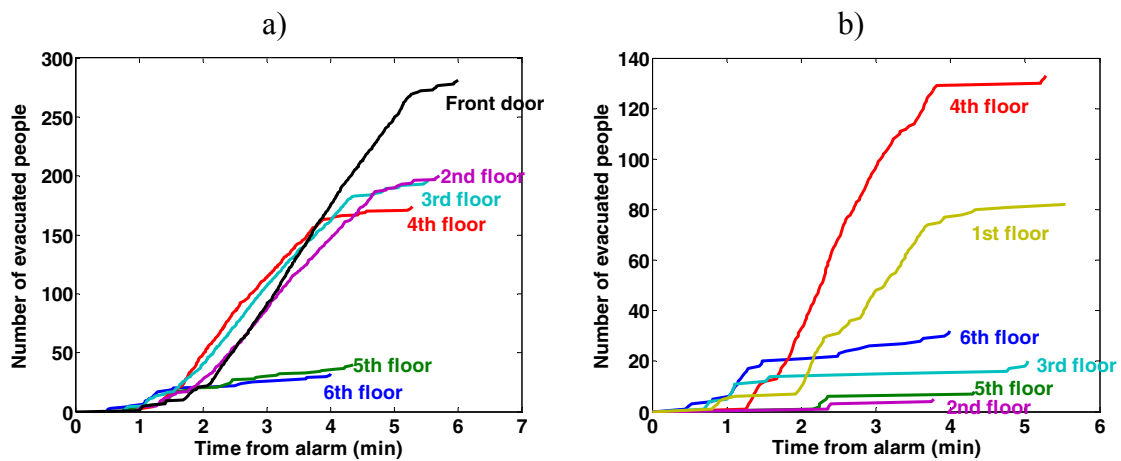

Figure 9. Number of the evacuated people from staircase. a) Accumulated starting from 6th floor and b) the number of persons per floor.

Table 4. The crowd flow rates in stairs and front door.

Curve ^a	J (flow rate) ^b [persons·s ⁻¹]	corridor/door width [m]	J_s (specific flow) [persons·s ⁻¹ ·m ⁻¹]
Front door ^c	1.35	1.07	1.26
2 nd floor ^d	1.04	1.27	0.82
3 rd floor ^d	1.05	1.27	0.83
4 th floor ^d	1.02	1.27	0.80

^a Derived from Figure 9.

^b The linear part of the slope is calculated person values ranging from 50 to 150.

^c Flow rates on the floor.

^d Flow rates on stairs.

The walking speed on stairs versus crowd density is presented in Figure 10. We notice that the crowd density has a strong effect on the walking speed when the crowd density is smaller than $0.5 \text{ persons}\cdot\text{m}^{-2}$. The difference between male and female data is not remarkable.

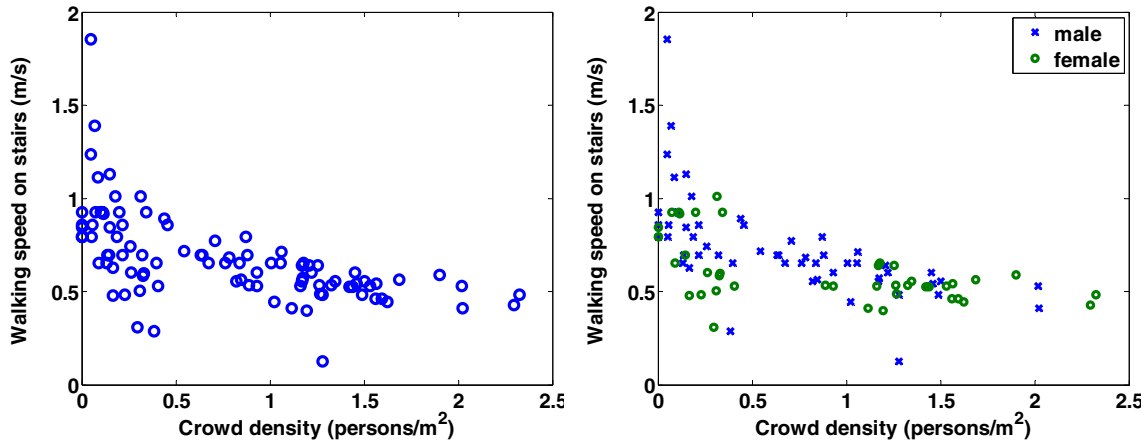

Figure 10. Walking speed on stairs as a function of crowd density. On the right side walking speeds are presented between male and female. Data points are derived from the traces of the RFID tagged persons in the staircase 2.

The overall cumulative distribution function for walking speeds on stairs is shown in Figure 11. The data points are also fitted against lognormal distribution function, which shows good correlation. The median of the fitted curve is 0.64 m/s and 95% fractile value is 1.04 m/s .

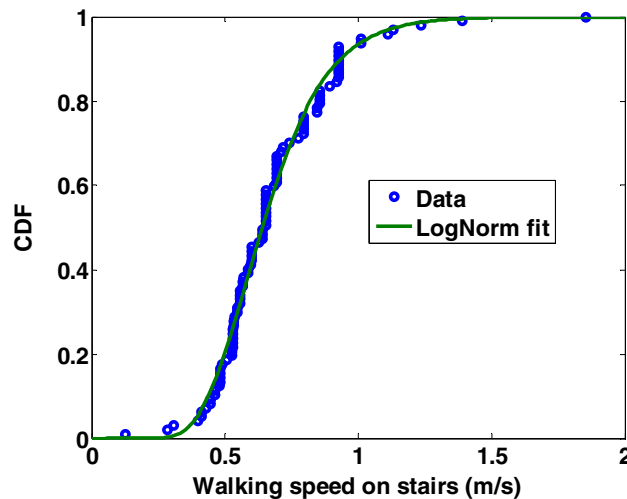

Figure 11. Cumulative distribution function of walking speeds on stairs and lognormal fit to data. The lognormal distribution function parameter values were $\mu = -0.4471$ and $\sigma = 0.2954$.

4.4 Evacuation from a medium sized office building

The third experiment was carried out in a medium sized office with about 300 people working in the building. The personnel of the office building were informed beforehand only the day when the evacuation would take place. Unfortunately, in the day of the evacuation, the number of the workers was much lower than normally. The building has 4 floors and 5 exits described in Figure 12. The door 5 is main entrance to the building and other 4 doors are used only in evacuation purposes. Doors 1–3 lead to inner court of the building from where the archway leads to the street. Door 4 leads straight to the archway, see Figure 12.

The cold smoke generator was placed inside the staircase 2, which was a very familiar route for the office staff. By blocking the familiar route, it was expected that most of the personnel would use the corridor and staircase 1. To escape through the staircase 1, people should leave the staircase at the correct floor, enter the corridor and after walking a few meters in the corridor, exit the building to the inner court.

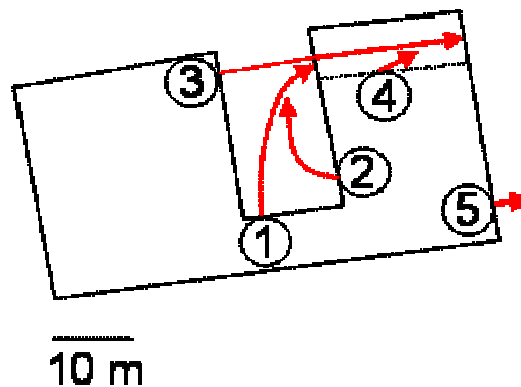

Figure 12. Medium sized office building having 5 evacuation routes illustrated with arrows.

The RFID antennas were placed inside an internal staircase 1 and on floor outside the staircase. Test persons and tags were divided into four groups, which were marked with ID badges with colour code and a tag inside. Written instructions of proper attachment of the ID badge were delivered to each test person. The DV-camera installation focused on recording the events on the expected escape route through the internal staircase 1 and additionally, outside the building.

The smoke detector in the staircase 2 went off in less than 3 min from the start of the smoke generator. Most of the people came out from the main door (door 5). The door 3, which was assumed to be less familiar, was used extensively due to the guidance from the safety organisation. Inside the building, only few people used the corridor and the staircase 1. Observations at the staircase 1 revealed how difficult it was to come out

from the staircase at the right floor level leading to a right exit. Two groups of 4 and 7 persons were observed to follow the first person all the way to down the basement, until they noticed that they are at wrong floor. After this they had to ascend one floor to reach the corridor and exit. These events took about 30 s for the first group and 40 s for the second group. The cumulative sums of evacuated people for each door and the total are shown in Figure 13. The zero time corresponds to the moment of fire alarm. Most of the people came out from the door 5 (the main door) and the door 3. Total number of the evacuated people was 139 within approximately 6 min.

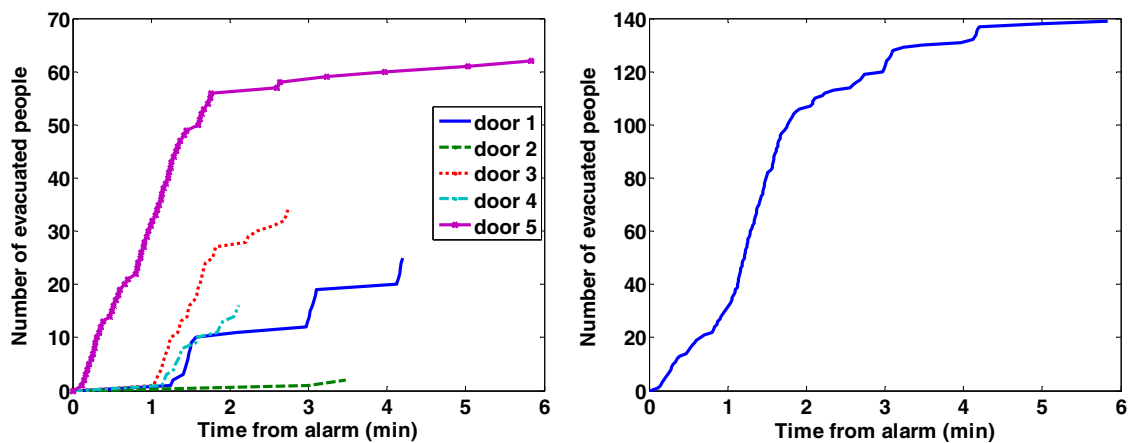

Figure 13. On the left side number of evacuated persons through different doors and on the right side the total number of evacuated person from the medium sized office building.

The flow rates determined from the Figure 13 are 0.54 persons/s for the door 3 and 0.58 persons/s for the door 5. Both values are quite low compared to literature values and our former evacuation cases. Only 30 people came out through the door 1 and only about 15 of them through the staircase 1.

The percentage of persons identified by RFID was a little bit better than in the public library evacuation but much smaller than in the large office building. This is mostly due to the fact that many of the test persons did not attend the test.

4.5 Surveillance cameras as a source of evacuation data

Even though the organized fire drills and evacuation exercises may provide important information when planned and implemented carefully, there are some inherent problems as well. First, the information of the evacuation to come is usually provided in advance, at least for some people, and the human behaviour may not be similar to the behaviour during a real evacuation situation. Second, it is quite expensive to organize the

experiments. Despite the new technical monitoring techniques, the implementation is laborious and time consuming. If the experiment is performed in business spaces, the costs for the business as a loss of sale or loss of work time may be considerable.

On the other hand, real fires and false alarms do take place every now and then, and usually they cause the evacuation of the building. From the evacuee's viewpoint, these evacuations are real, and the behaviour corresponds to an actual fire situation. The collection of data from these events might therefore be an effective means of research.

Many public buildings are nowadays equipped with surveillance cameras for security purposes. The modern surveillance camera systems have digital storage of the video material, and the video material from each camera can be viewed and processed afterwards. The utilization of such a video material was tested to find out the feasibility of surveillance cameras in research purposes.

A large shopping centre in southern Finland had a false fire alarm in February 2007 due to a frozen sprinkler head. At the moment of the alarm, there were more than 1000 customers in the building. The whole building was not evacuated, because there were no other signs of a real fire, and because the weather outside was cold (about $-10\text{ }^{\circ}\text{C}$). The video recordings from four surveillance cameras were obtained. The quality of the video was relatively good, when compared to the surveillance cameras in general, but poorer than the quality of normal digital video cameras.



Figure 14. Snapshot of the surveillance camera during the shopping centre evacuation. The blue line shows the virtual counting line used in the analysis.

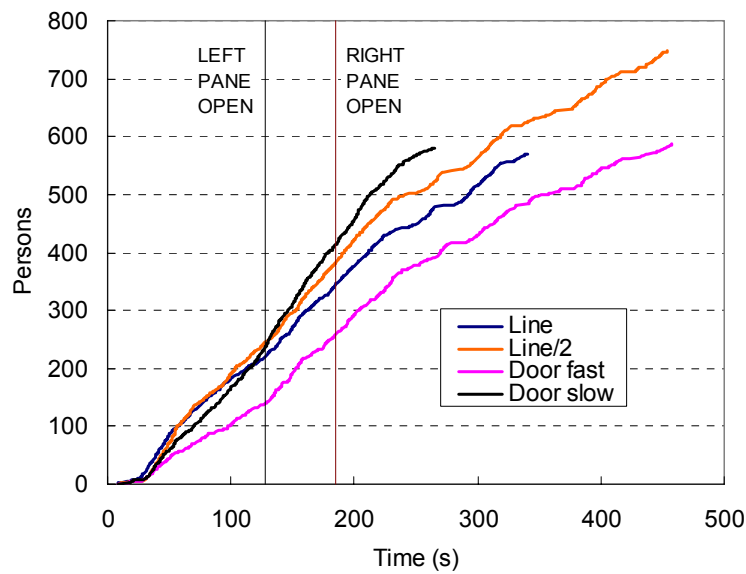

Figure 15. Flow out of the door during the shopping centre evacuation.

The flow of people for one of the entrances was counted using the Evaccounter tool. A snapshot of the video is shown in Figure 14, where people are heading towards the sliding door in the upper left hand side corner. The door has two sliding panes. On both sides of the door, there are doors with latches in the vertical frame. The left and right side doors were opened 128 and 185 s after the alarm, respectively. In the picture, the left side latch door is already open.

The cumulative sum of people evacuated through the door is shown in Figure 15. The people re-entering the building were neglected. The four results in the figure correspond to the different positions (virtual counting line or door) and different playing speeds of the video during the counting. The differences between the results can be considered as representing the uncertainty of the counting process. The number of people observed at the virtual line was clearly higher than what was observed at the door using high speed video playback. The flow rates corresponding to the four counting methods are shown in Figure 16. Some of the oscillations are probably caused by the numerical derivation process. When the highest peaks are omitted, we can say that the highest flow rate of 1.6 (m s)^{-1} is found in the initial phase of the evacuation. After the opening of the second latch door, the flow rate goes down to 0.6 (m s)^{-1} .

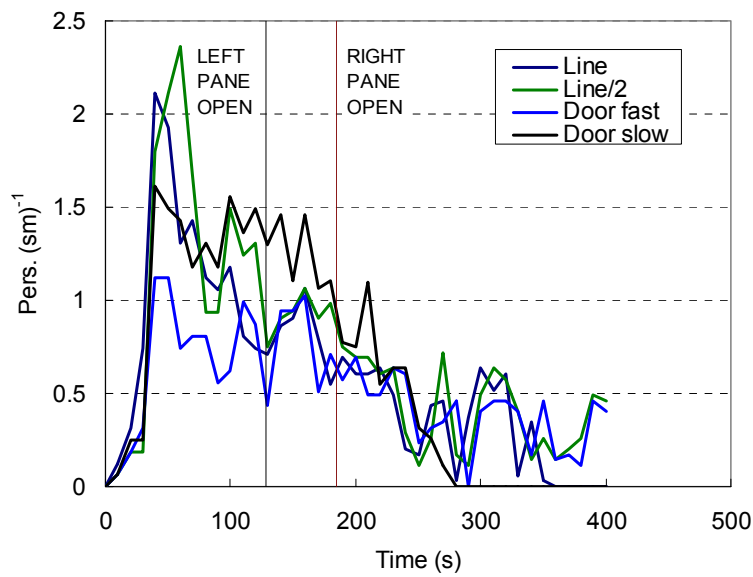

Figure 16. Flow rate out of shopping centre door.

These results demonstrate that the surveillance cameras can be used as a source of detailed information on the evacuation in public spaces. However, the orientation of the cameras is crucial for the reliability of the counting. For good results, a perpendicular and unrestricted view on the evacuation path should be available. These conclusions apply only to the counting of people flows. Observation of reaction and pre-movement times was not possible from the available videos. In the future, the surveillance cameras may provide a valuable source of information on the realistic behaviour of people in fires on public places.

5. Verification and validation of FDS+Evac

Within this section, the notation FDS5+Evac means the current version of the software based on FDS v.5 and human description as three circles. FDS4+Evac means the older version based on FDS v.4.07 and human description using only one circle. FDS+Evac means the software in general, without specifying the version, and is used if the computations are presented with both versions.

In the verification and validation test cases, the default parameter values for the various pre-defined human types of FDS5+Evac were used unless otherwise stated. The values of the default parameters are explained in the software manual [Korhonen & Hostikka 2008]. In many cases, the anisotropy parameter of the social force was varied from the default value of 0.5 to 0.3.

5.1 Verification of the human movement algorithm

The movement algorithm of FDS5+Evac was tested first using some simple geometries to show that the agents do not walk through walls and that their speed is correct and they move towards the exit doors which the user has specified in the input. These simulations were done in an evacuation trial mode, i.e., there was no smoke or fire calculation present in the simulations. The effect of smoke on the walking speeds and the FED calculation were tested separately.

5.1.1 IMO qualitative verification tests

The qualitative verification cases of the human movement algorithm are based on the International Maritime Organization (IMO) document “Interim Guidelines for Evacuation Analyses for New and Existing Passenger Ships” [IMO 2002], where eleven different test cases are listed. These tests and how FDS5+Evac performed in these are summarized below and the input files and results of the simulations can be found from the FDS+Evac web page.

Note, that below are given results of just a one FDS5+Evac simulation per each scenario. Usually, repeated simulations give slightly different results because FDS5+Evac is a stochastic modelling program, i.e., it uses stochastic distributions to generate the initial positions of the agents and their properties, and because there are some small random forces and torques in the equations of motion. For the qualitative verification however, a single simulation should be sufficient. For quantitative validations, several simulations should be performed.

1. *Maintaining set walking speed in corridor*: One person with a walking speed of 1.0 m/s should walk a 40 m distance in 40 s. FDS5+Evac passed the test.
2. *Maintaining set walking speed up staircase*: One person with a walking speed of 1.0 m/s should walk a 10 m distance in 10 s. FDS5+Evac passed the test. Both existing models for staircases ('&CORR' and '&EVSS' namelists in the input) were used.
3. *Maintaining set walking speed down staircase*: One person with a walking speed of 1.0 m/s should walk a 10 m distance in 10 s. FDS5+Evac passed the test. This test is actually the same as the test number 2, because the staircase algorithm of FDS5+Evac is the same for up and down, only the user input for the speed reduction factor is changed.
4. *Exit flow rate*: 100 persons in a room with a 1.0 m exit, the flow rate should not exceed 1.33 p/s. FDS5+Evac passed the test, if an 'Adult' with the parameter value $\lambda_i = 0.3$ is used. The default for this parameter is 0.5. See also the door flow test case in Section 5.3.4. It should be noted that larger specific flows through doors than 1.33 p/s/m are obtained if a wider door is used.
5. *Response time*: Verify that the humans start to walk according to a given uniform reaction time distribution. FDS5+Evac passed the test. FDS5+Evac prints out the main personal properties of the agents, including their response and detection times, unimpeded walking velocities, main body diameters, motive force time constants τ_i , and the initial positions.
6. *Rounding corners*: Persons approaching a corner will successfully navigate around the corner without penetrating the boundaries. FDS5+Evac passed the test. The social force model used for the movement of the agents does not allow the agents to go inside walls if the time step is small enough as it is in FDS5+Evac for reasonable values of the model parameters.
7. *Assignment of population demographics parameters*: Distribute the walking speeds over a population of 50 people and show that the walking speeds are consistent with the distribution specified in the input. FDS5+Evac passed the test, see the test number 5 above.
8. *Counterflow – two rooms connected via a corridor*: Two 10×10 m² rooms are connected with a 10 m long and 2 m wide corridor. Initially there are 100 persons in the room 1 and the room 2 has 0, 10, 50, 100 persons and both rooms move off simultaneously. The expected result is that the time the last person

from the room 1 enters the room 2 increases as the number of persons in counterflow increases.

FDS5+Evac results were 43 s and 344 s for the cases, where there were 0 and 10 persons in the room 2, respectively. The case, where there were 50 persons in the room 2, resulted a very slow movement towards the room 2 and the simulation was not run until the end. If there were 100 persons in the room 2 then there were practically no movement in the corridor, i.e., a total jam was formed.

9. *Exit flow – crowd dissipation from a large public room:* A 30×20 m² public room with four 1.0 m wide exits has 1000 persons. Calculate the time the last person leaves the room. Close two doors and repeat the calculation. The expected result is an approximate doubling of the time to empty the room.

FDS5+Evac passed the test. The total evacuation times calculated using the default person properties were 188 s and 354 s when all four doors were open and when two doors were closed, respectively. These times were 248 s and 470 s when the parameter value λ_i is changed from the default, which is 0.5, to 0.3. Note that the flows through the 1.0 m doors were below 1.33 p/s when an ‘Adult’ with the parameter value $\lambda_i = 0.3$ is used. The default for this parameter is 0.5 and then flows through the doors are slightly larger. See also the door flow test case in Section 5.3.4.

10. *Exit route allocation:* Populate a cabin corridor section with 23 persons and allocate the main exit for 15 persons and the secondary exit for 8 persons. The expected result is that the allocated passengers move to the appropriate exits. FDS5+Evac passed the test.

11. *Staircase:* A room populated with 150 persons is connected to a 2.0 m wide and 12 m long corridor which ends to a 2.0 m wide stairs going upwards. The expected result is that congestion appears at the exit from the room, which produces a steady flow in the corridor with the formation of congestion at the base of the stairs.

FDS5+Evac passed the test, if the user is giving reasonable input parameters for the definition of the staircase. Both models for staircases (‘&CORR’ and ‘&EVSS’ namelists in the input) were used.

5.1.2 FED calculation

To test the implementation of Fractional Effective Dose (FED) concept [Purser 1995] a simple one room geometry with a fire source and one agent in the middle of the room is used. The agent is fixed at its initial position by setting the detection time large and random noise of the movement equations to zero. FDS point measurements of the gas densities are placed at the position of the agent. The FDS5+Evac output for the value of the maximum FED among the agents is compared to a value computed using an external worksheet and the FDS point measurements for gas densities. The results of the comparison are shown in Figure 17. The results indicate that the FED calculation in FDS5+Evac is working correctly.

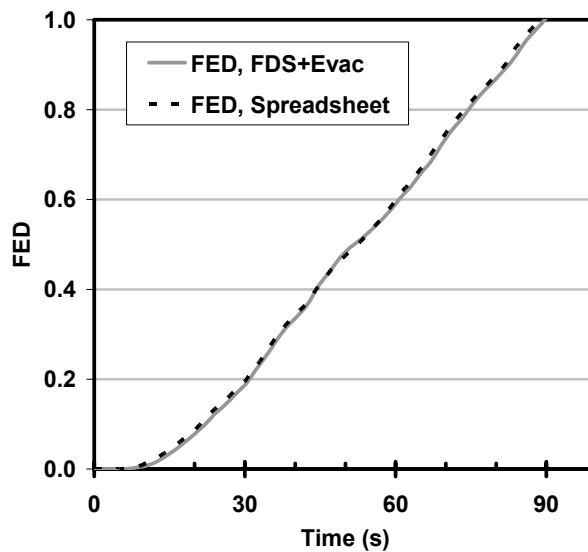

Figure 17. The test on the FED calculation.

5.1.3 Unimpeded walking speed vs. smoke density

Smoke reduces the walking speed due to the reduced visibility. The prediction of this effect is tested in long corridor geometry. The source code of FDS5+Evac was modified a little bit for this test to use an artificial smoke density history with stepwise behaviour in the evacuation calculation: soot density (extinction coefficient) was increased by 114.9 mg/m^3 (1.0 m^{-1}) after every 10 seconds. The length of the simulation was 100 s and the unimpeded walking velocity for a smoke-clear environment was set to 1.0 m/s. The result of this test is shown in Figure 18. In the figure, the line labelled as “Theory” is the experimental correlation given in Eq. (10). The velocities were calculated using 8 s periods, like 22 s – 30 s, because an agent needs a little bit time to adjust its speed (the inertia of mass) when the smoke density is changed. The results show that FDS5+Evac accurately reproduces the anticipated reduction of walking speed.

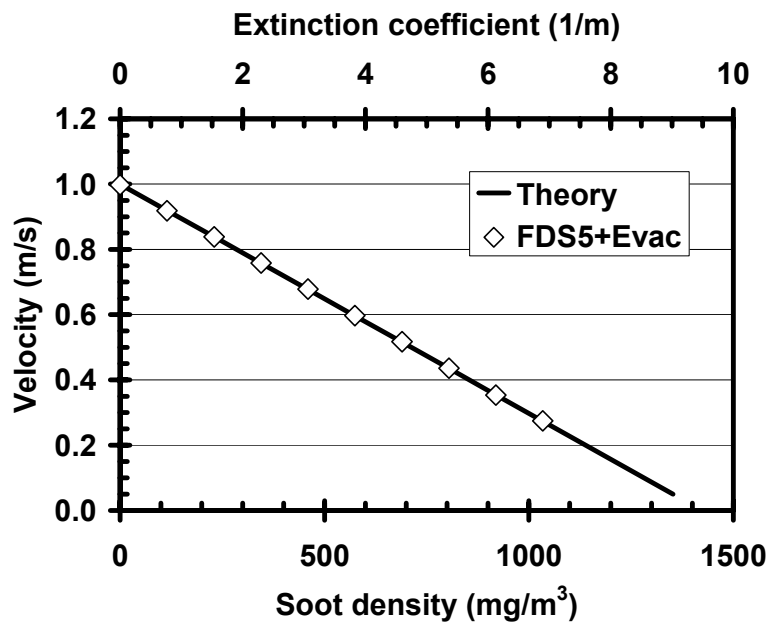

Figure 18. The test on the smoke vs. movement speed correlation.

5.2 Verification of the decision making model

The verification of the exit door selection algorithm of FDS5+Evac was tested using the geometry shown in Figure 19. The figure on the left shows the target exit doors for the agents (blue: right bottom exit; green: top left exit) and in the figure on the right the colours of the agents mark the preference categories of the exit door selection algorithm (black: known visible door; yellow: known non-visible door). This test case has no smoke and as a result, agents use only the known doors (top left and bottom right ones). The doors on the left and right walls are not used because they are not defined as ‘known doors’ in the input. Figure 19 verifies that the door selection algorithm works as intended when there is no smoke. Agents first choose the nearest visible known door if such exists. If there are no visible doors, the agents choose the nearest non-visible but known door; see e.g. the agents in the bottom left corner of the building. Note however, that in the present version of FDS5+Evac, the distance to the non-visible doors is calculated along a straight line through the internal walls. In later versions, the algorithm may be changed to calculate the distance along the streamlines used to guide the agents towards the doors.

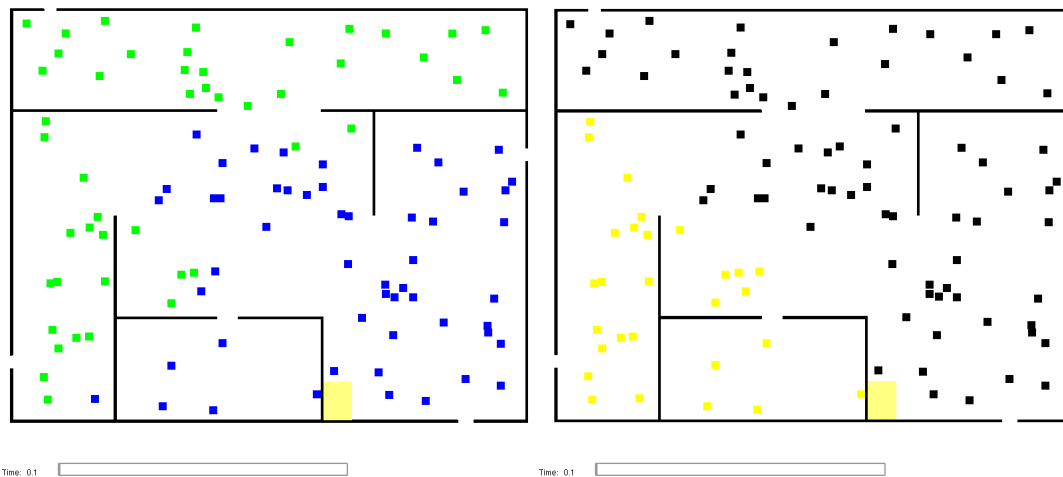

Figure 19. The test used to verify the exit door selection algorithm of FDS5+Evac. On the left, agents are coloured according to their exit doors. On the right, they are coloured according to their current preference categories.

The above test was modified by adding a fire that produces smoke to the building. Figure 20 shows the visibility at the height of the human eyes at 10 s from the ignition. The door selections and preference categories at the same time are shown in Figure 21. Now the smokiness has changed the preferences. First choices are still the doors with no smoke. The input files for these tests are on the FDS+Evac web page an interested reader is able to re-run the simulations and use Smokeview to see that the door selection algorithm is functioning like intended.

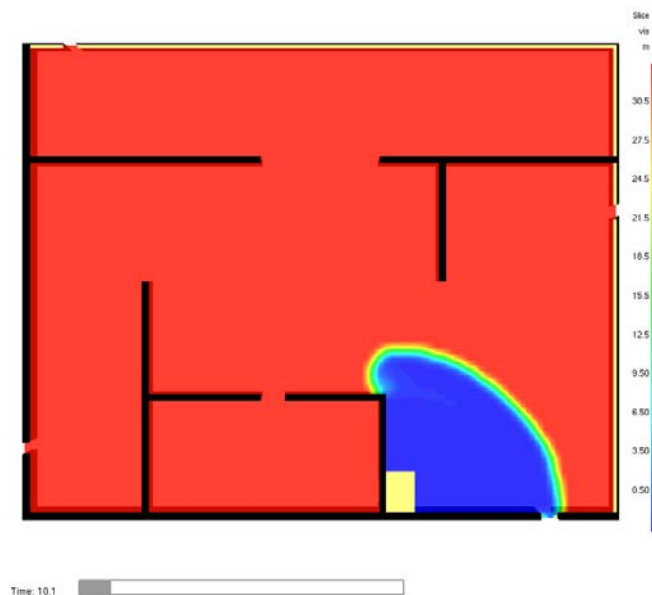

Figure 20. The visibility at 10 s in the test case. Red and blue colours indicate good and very bad visibilities, respectively.

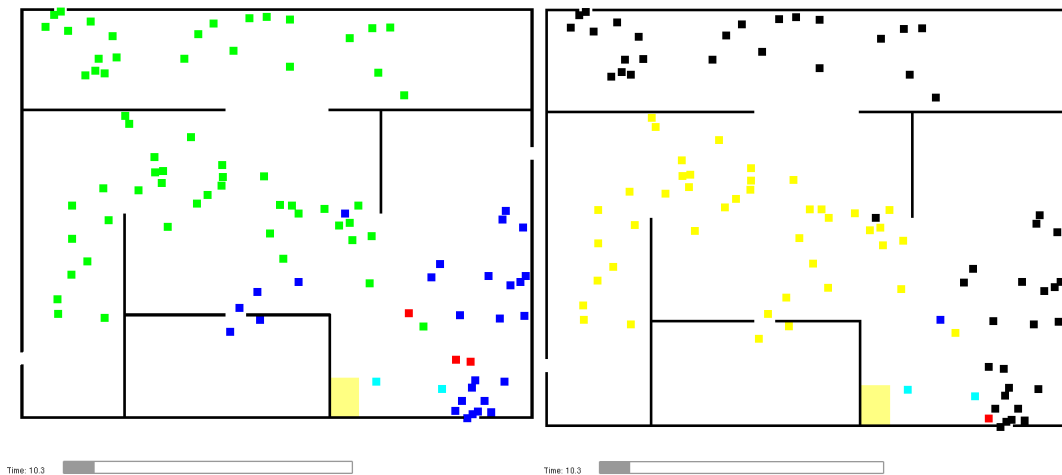

Figure 21. A snapshot (10 s) of the door selection test with smoke. The smoke position is shown in Figure 20. On the left, agents are coloured according to their exit doors. On the right, they are coloured according to the preference categories.

5.3 Validation of the human movement algorithm by comparison to other simulation programmes

5.3.1 Sports hall

FDS5+Evac simulations were compared to Simulex [Integrated Environmental Solutions Ltd. 1996] simulations in a sports hall shown in Figure 22. The hall was previously analysed by Paloposki *et al.* [2002]. The sports hall is used to practice different kind of sports. There are no spectator stands in the hall and neither are there any social spaces like showers. People enter the hall through the main entrance (‘Door 1’), which is 1.8 m wide. Doors 2 and 3 are 4.0 m wide two leaf doors and doors 4 and 5 are 0.9 m wide single leaf doors. It is assumed that a fire starts close to door 3 (the shaded rectangle in Figure 22) so that this door cannot be used for egress. 235 persons use the closest door (‘Door 5’), 130 persons use the main entrance (‘Door 1’), 60 persons door 2, and 75 persons use door 4. Persons are initially located at the east end of the hall in an area of $20 \times 25 \text{ m}^2$ (the open rectangle in Figure 22). Three different reaction time scenarios were considered, two having a normal distribution with a standard deviation of 15 s but different means (60 s and 180 s), and one having a log-normal distribution (median 75 s, standard deviation of the logarithm of reaction time was 0.7). Actually, the log-normal distribution was approximated by two uniform distributions, because the version of the Simulex, which was used, does not support log-normal distributions for the reaction time.

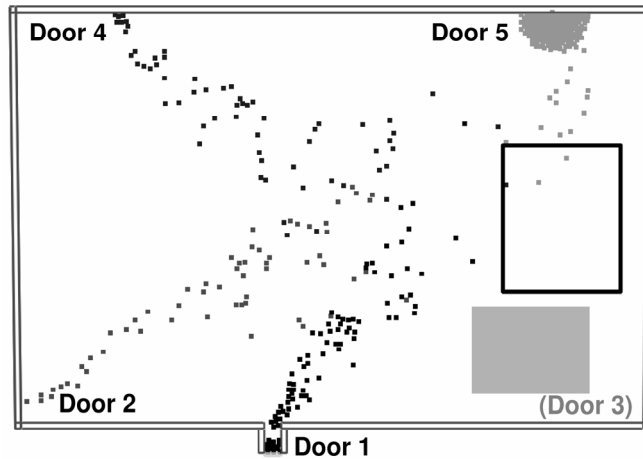

Figure 22. The geometry of the studied sports hall. The open rectangle shows the area, where the agents are at the start of the simulations. The gray rectangle shows the fire location, which is close to door 3 and, thus, this door is not used.

The results of the simulations are shown in Figure 23. Since both FDS5+Evac and Simulex are modelling human egress as a stochastic process, the presented results were collected from five runs per case. The FDS+Evac and Simulex results agree very well for the log-normal reaction time case, but for the other two cases the results differ somewhat. These differences arise due to the ‘Door 5’, which is only 0.9 m wide, but through which 235 persons escape. The flow through this door is larger in Simulex than in FDS+Evac. The specific human flow through this door in the FDS5+Evac simulations is 1.65 1/p/m for the cases, where normal distributions were used for the reaction times. The other doors are not as crowded and there the capacities of the doors do not show up as much.

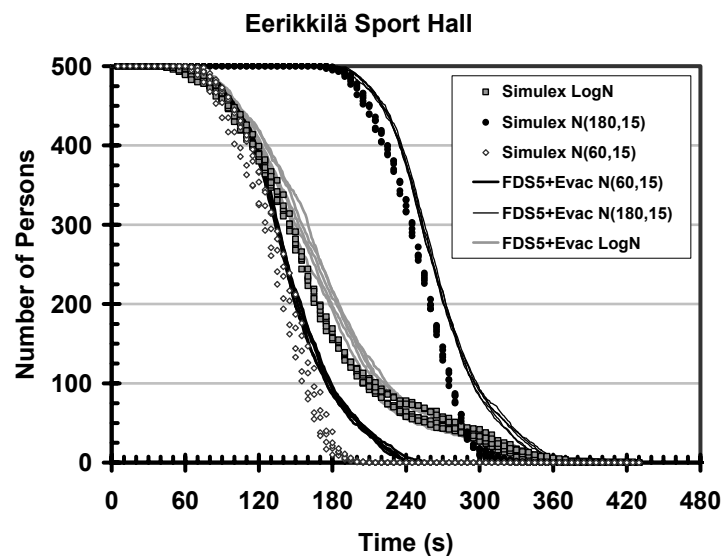

Figure 23. The comparison of FDS5+Evac to Simulex in a sport hall case. Results of five different simulations are shown for each case.

In Figure 24, the results of the present version of FDS+Evac (FDS5+Evac) are compared to the results of an older version (FDS4+Evac), where the shape of the human body is approximated using one circle [Korhonen *et al.* 2005]. Shown are also the results of Simulex simulations. Note, that the curves and markers in Figure 24 represent the averages of the simulations, typically 5 simulations per case. It is seen that for this case the different versions of FDS+Evac give practically the same results.

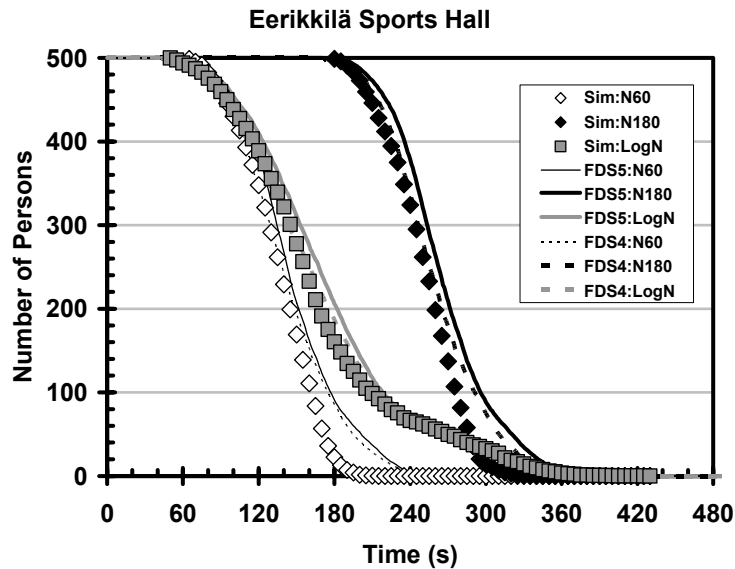

Figure 24. The effect of the three-circle (FDS5+Evac) versus one-circle model (FDS4+Evac) of human body and a comparison to Simulex results in a sport hall case. Shown are averages of the simulations.

5.3.2 Assembly space

The second test case is a large fictitious assembly space having dimensions of 50×60 m² and 1000 people initially inside. There is only one 7.2 m wide corridor leading to the exit. The geometry is shown in Figure 25. The FDS+Evac results are compared to those of Simulex and buildingExodus [Thompson & Marchant 1995] in Figure 26. Note, that the FDS5+Evac simulations were also done using parameters describing more relaxed egress (labels ‘FDS5+EvacSlow’), where the value of the anisotropy parameter of the social force, λ_i , had a value of 0.3.

Considerable differences are shown between the results of FDS+Evac and the results of Simulex and buildingExodus codes. These differences can be traced back to the human motion in the corridor, see Figures 27 and 28. Simulex and buildingExodus are not using the whole width of the corridor efficiently, when the simulations are done using the default values and standard input. (An advanced user of these codes might be able to

get different results by using some additional features.) The results of FDS+Evac model look more realistic.

In addition to the corridor simulations, Figure 26 shows also the results from a case, where the corridor was replaced by a single 7.2 m wide door. In this case, the agreement between the different evacuation programmes is much better. The calculated specific human flows (1/p/m) are: Simulex 1.44, Exodus 1.95, FDS4+Evac 2.28, FDS5+Evac 2.14 and FDS5+EvacSlow 1.74 ($\lambda_i=0.3$).

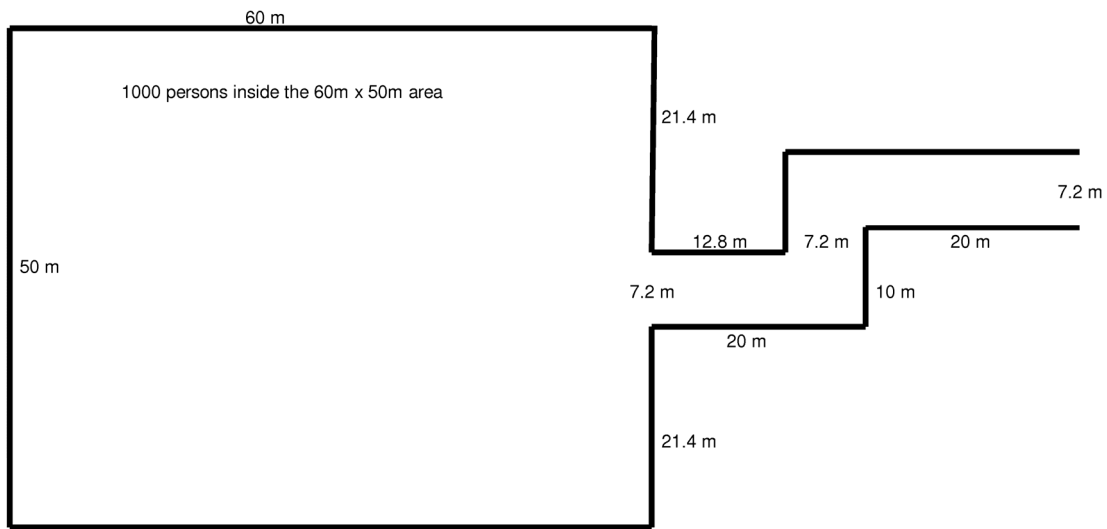

Figure 25. The geometry of the assembly space test case.

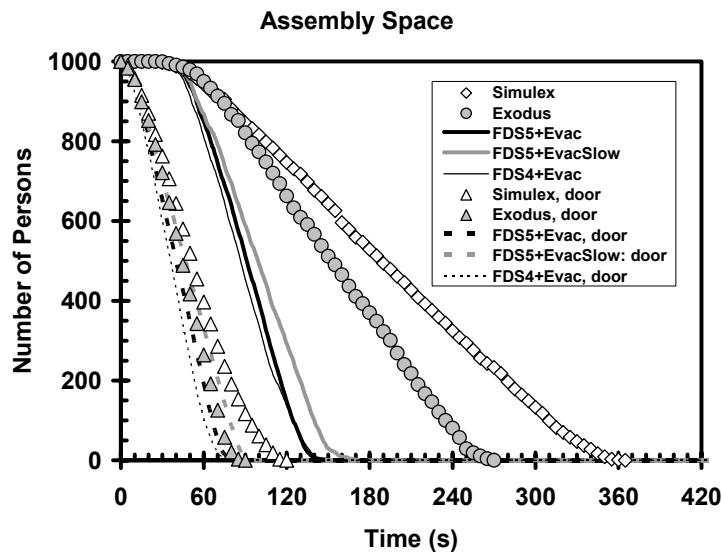

Figure 26. The comparison of FDS5+Evac to FDS4+Evac, building Exodus and Simulex in an assembly space.

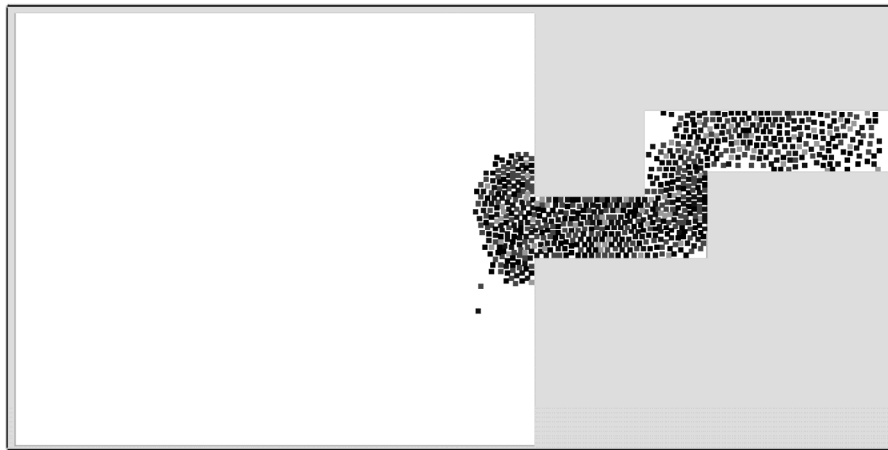

Figure 27. A snapshot from a FDS+Evac calculation.

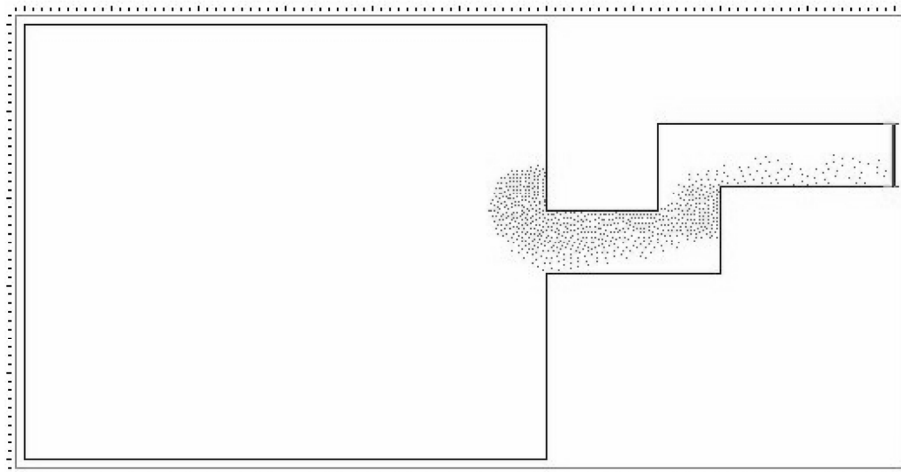

Figure 28. A snapshot from a Simulex calculation.

5.3.3 Open floor office

The third test geometry was an open floor office, whose floor plan is shown in Figure 29. The floor has dimensions of $40 \times 40 \text{ m}^2$ and there are initially 216 persons on this floor. The properties of these persons were based on the ‘Office Staff’ category in the Simulex model and the reaction times were assumed to follow a normal distribution with mean of 90 s and standard deviation of 11 s. There are three stairs located at the central core of the building. The widths of the doors opening to the stairs are 1.2 m. In total, seven different egress scenarios were simulated, covering the cases where all stairs were in use, one stair was blocked and a case where two stairs were blocked.

The results of FDS5+Evac simulations are compared to Simulex simulations in Figure 30. Queues were formed only when two exit doors were blocked. For two or three

operational doors, the main form of the evacuation curves arise from the reaction time distribution. The FDS5+Evac and Simulex results are quite similar. It should be mentioned, that in the FDS5+Evac simulations, the initial (random) positions of humans do not change between different door scenarios (see Figure 29), whereas in Simulex runs the random initial positions are different in each calculation. This explains why the Simulex results have larger scatter in the cases where a certain number of doors are operational.

The effect of the human body model (one circle vs. three circles) is shown in Figure 31 comparing the FDS5+Evac and FDS4+Evac results. No large differences are found between the results of the different versions of FDS+Evac in this test geometry. This is due to the fact that the parameters of FDS5+Evac and FDS4+Evac are chosen similarly, i.e., that they produce about similar specific flows through doors.

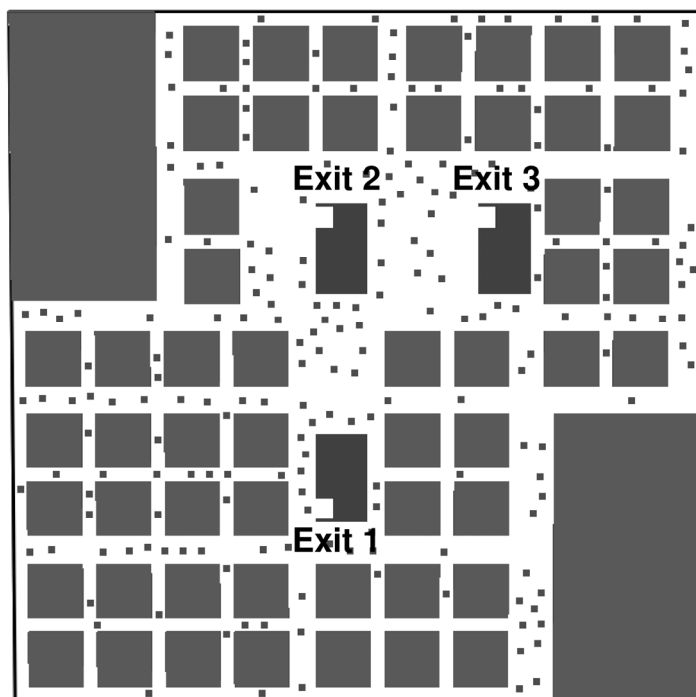

Figure 29. The geometry of the open floor office test case.

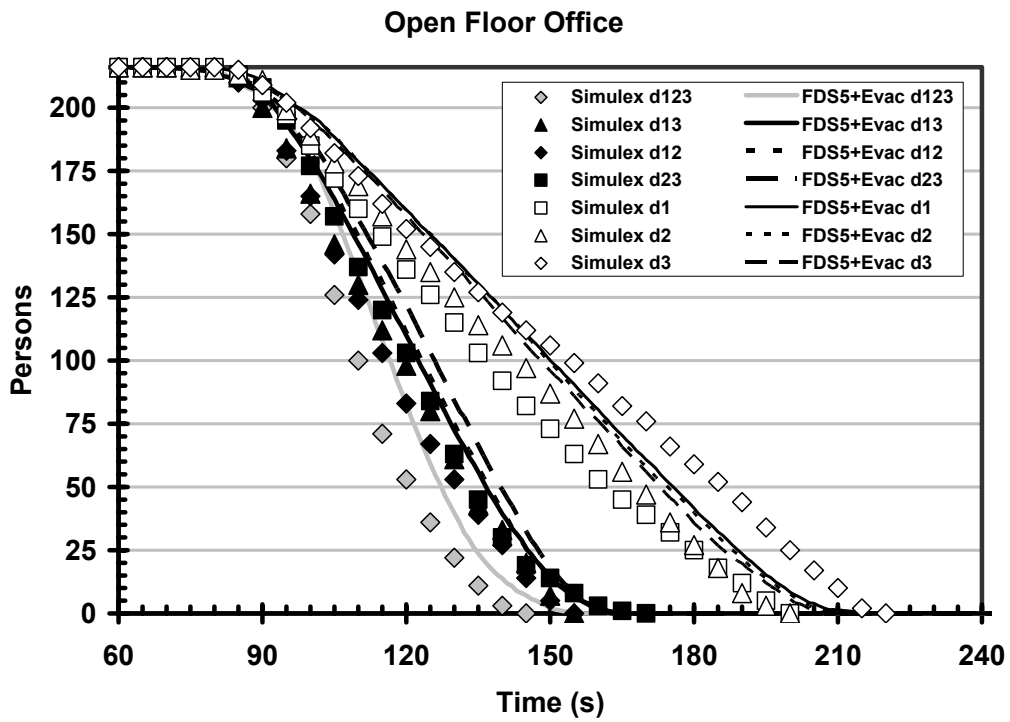

Figure 30. The comparison of FDS5+Evac to Simulex in an open floor office case.

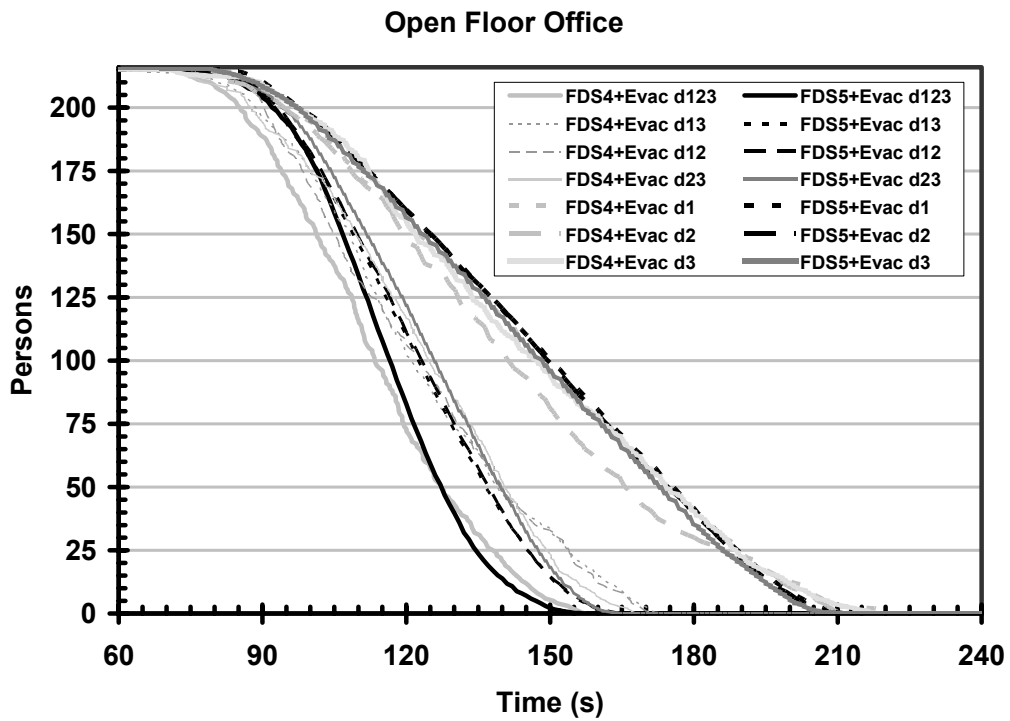

Figure 31. The comparison of FDS5+Evac to FDS4+Evac in an open floor office case.

5.3.4 Specific flows through doors

The fourth test geometry is shown in Figure 32. This geometry is commonly used in the literature to calculate the specific flows through doors. In the test, there are 100 humans randomly located at the $5 \times 5 \text{ m}^2$ square. In Figure 33, the results of FDS+Evac simulations for specific flows through doors are compared to simulation programmes Simulex and MASSEgress [Pan 2006]. The results of the programmes MASSEgress and Simulex are extracted from Pan's thesis [Pan 2006]. The FDS5+Evac simulations are performed with two different parameter sets, labels "1" refer to the defaults of FDS5+Evac and labels "2" refer to parameter sets, where $\lambda_i = 0.3$ is used.

FDS5+Evac predicts reasonable flows through doors. For some applications, the flows generated by the default parameter values may be considered too large, but it is quite straightforward to modify the parameters of FDS5+Evac to reach specific flows that are more relevant to a more relaxed egress. The results of FDS4+Evac simulations show somewhat smaller specific flows through doors than FDS5+Evac. This difference is caused by the initial density of humans. In the geometry of Figure 32, the initial human density is 4.0 p/m^2 , but this density can not be achieved in the FDS4+Evac simulations, where the human body size is approximated by a single circle.

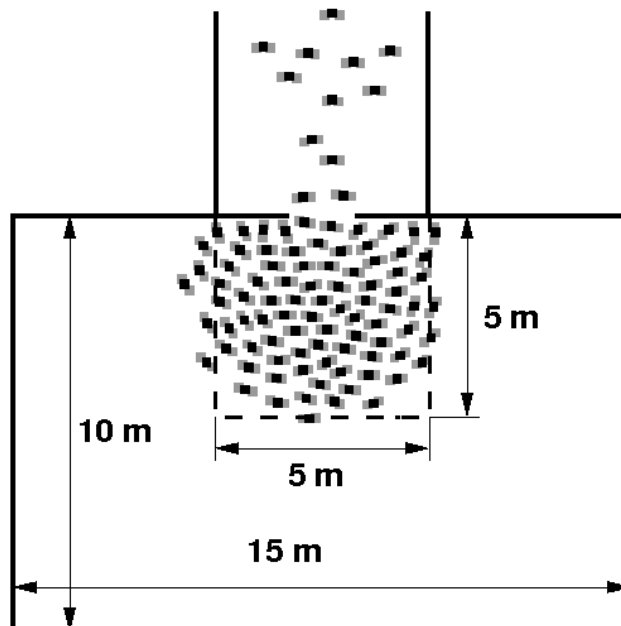

Figure 32. The test geometry used to calculate specific human flows through doors.

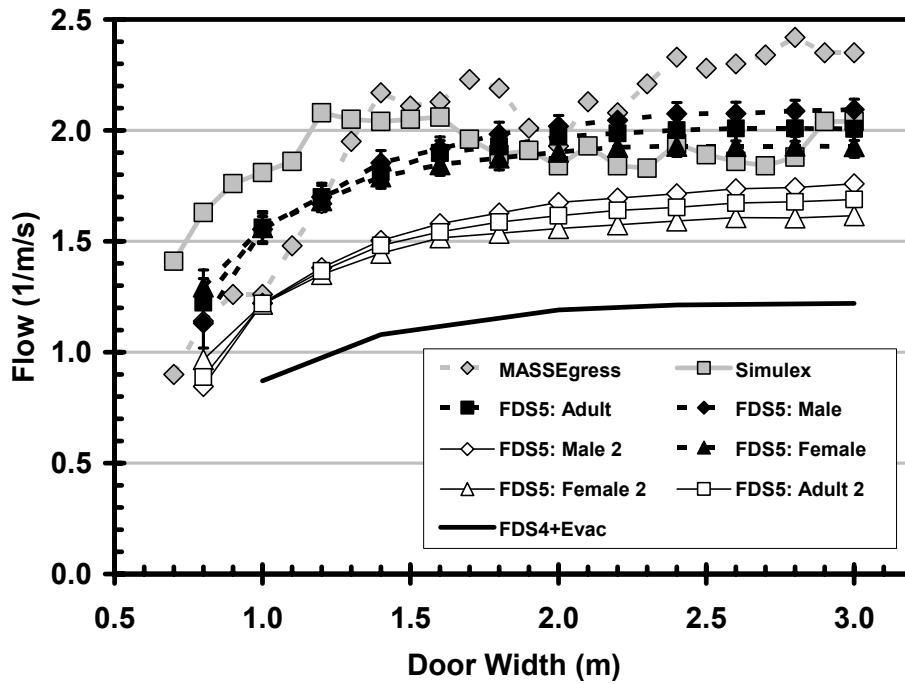

Figure 33. The specific human flows through doors.

5.4 Experimental validation of the human movement algorithm

5.4.1 Flows in corridors

In the research of pedestrian flows, the dependence of the specific human flow rate on the human density is called a “fundamental diagram”. It shows how the specific flow first increases when the human density is increased, but then starts to decrease as the density becomes high enough to hinder the walking. In this test case, the specific flow rates given by the FDS+Evac code are compared to experimental walking velocities on horizontal floors in corridor geometry, shown in Figure 34. The corridor is modelled as a loop to avoid the effects of inflow and outflow boundary conditions. In Figure 35, the predicted flow rates are compared against some experimental results for pedestrian traffic flows taken from Daamen’s thesis [Daamen 2004]. The FDS5+Evac simulations were performed with two different parameter sets, labels “1” refer to the defaults of FDS5+Evac and labels “2” refer to parameter sets, where $\lambda_i = 0.3$ is used. The FDS4+Evac simulations were performed using two different (average) values, 0.5 s and 1.0 s, for the motive force time constant, τ_i , of the social force.

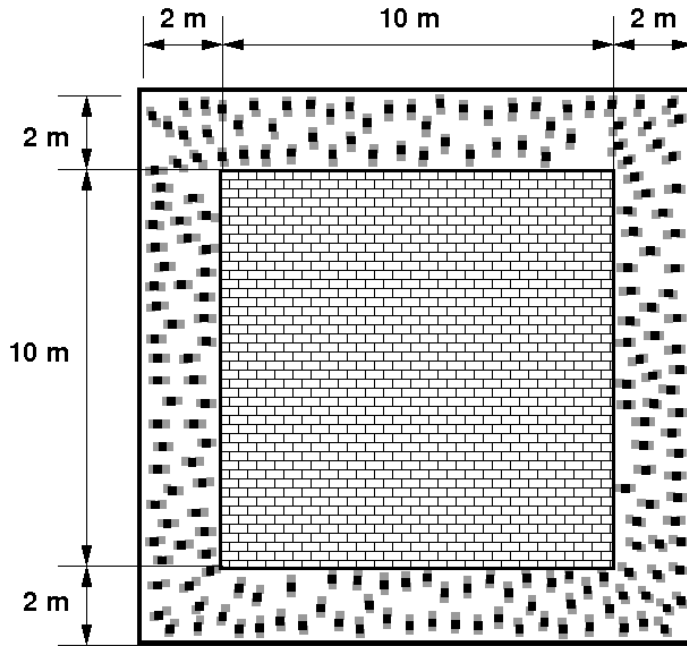

Figure 34. The geometry used to calculate the specific human flows in corridors.

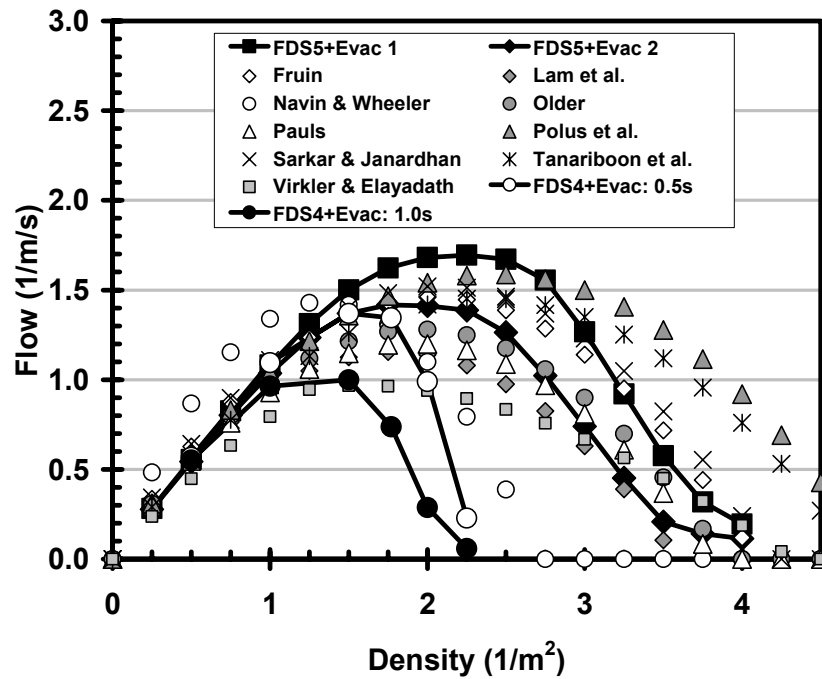

Figure 35. The specific human flows in corridors.

The results show that the present version FDS5+Evac provides a better agreement with the experimental data than the older version, FDS4+Evac. The reason is the more accurate modelling of the human body and, as a result, a better description of the high human

densities. The results of FDS5+Evac simulations reproduce both the experimentally observed trend and the quantitative values of specific flows. It is a matter of taste, which parameter set ($\lambda_i = 0.5$ or $\lambda_i = 0.3$) one should use in the simulations. The best practice for a fire safety engineer is to use both sets and see how much the results differ, which gives an indication on the uncertainty of the calculated evacuation times.

5.4.2 Staircase of a large office building

The evacuation experiment at the large office building was modelled using FDS5+Evac. Since the experiment was strongly focused on just one staircase, only this staircase was modelled. Figure 36 shows the geometry of the studied staircase. The actual dimensions and door positions can be found in the experimental report [Hostikka *et al.* 2007]. The experimental entry times of humans to the stair landings were taken as inputs to the simulations. The standard adult person type of FDS5+Evac was used in the simulations. Two different values were used for the anisotropy parameter of the social force, λ_i : 0.5 which is the default, and 0.3 which corresponds to more relaxed egress. The calculations for staircases were performed using both models for staircases available in FDS5+Evac.

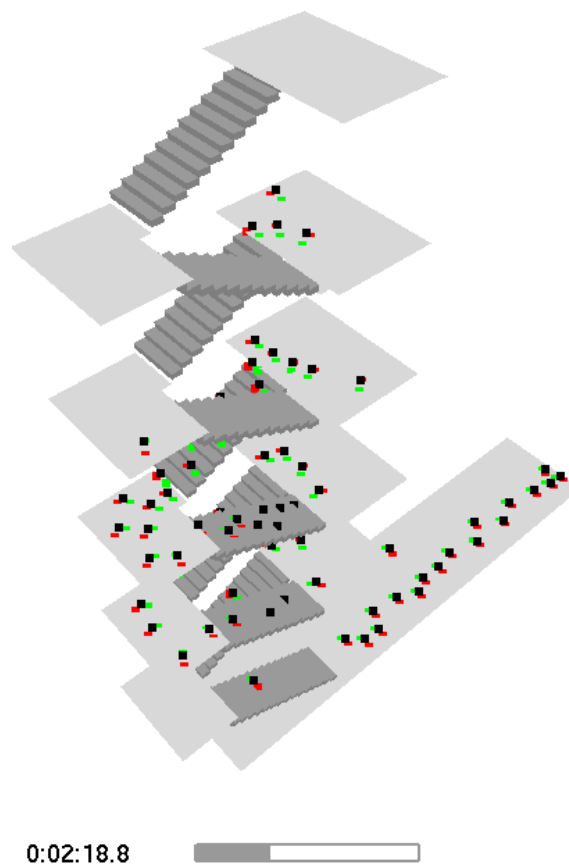

Figure 36. A snapshot from a FDS+Evac simulation showing the geometry of the staircase.

Figure 37 shows a comparison of the experimental observations and the simulation results using the simple staircase model (type 1). This model is implemented using the ‘&CORR’ namelist [Korhonen & Hostikka 2008], which is a crude model for stairs. In each figure, several simulated curves are shown corresponding to different values of the staircase speed reduction parameter. In Figure 37, the best results are obtained when the value for the speed reduction parameter is 0.5, i.e., persons movement speed is reduced to $v = 0.5v_0$ inside the staircase. The results using more sophisticated way of defining staircases (type 2) are compared to the observed values in Figure 38. In these simulations, the stairs are modelled as inclines where humans move at reduced speed. Reducing the walking speed by a factor ~ 0.7 gives a good agreement with the observations. Whether the anisotropy parameter λ_i is 0.3 or 0.5 does not have any effect of practical importance.

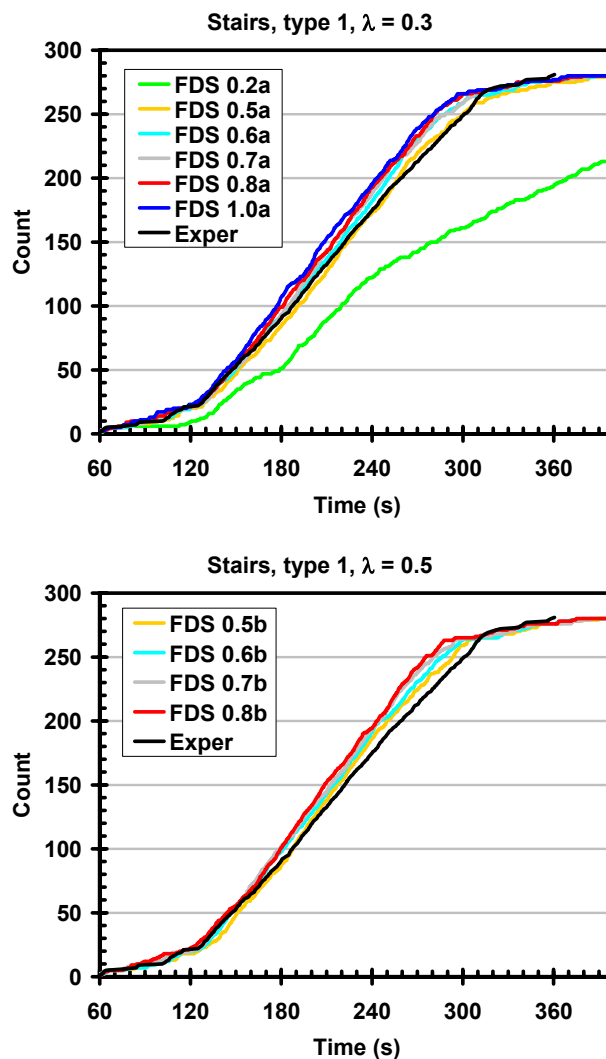

Figure 37. Comparison of FDS5+Evac (staircase model type 1) and experimental observations of a staircase flow. Values 0.3 (upper) and 0.5 (lower) for the anisotropy parameter of the social force are used. Different curves correspond to the different values of the staircase speed reduction parameter.

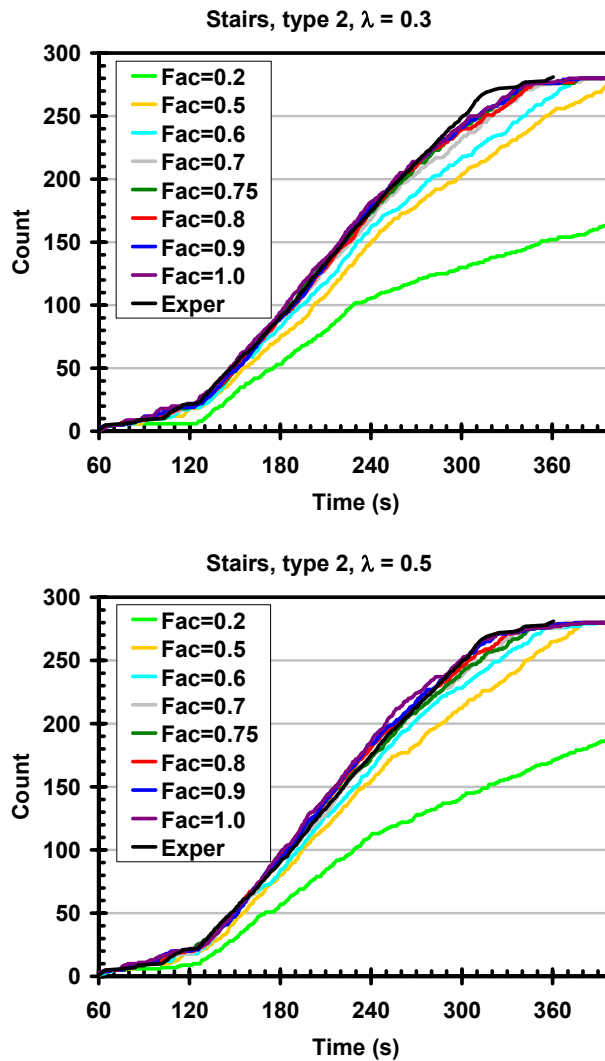

Figure 38. Comparison of FDS5+Evac (staircase model type 2) and experimental observations of a staircase flow. Values 0.3 (upper) and 0.5 (lower) for the anisotropy parameter of the social force are used. Different curves correspond to the different values of the staircase speed reduction parameter.

5.4.3 Evacuation from a public library

The evacuation experiment of the public library was simulated to study the capability to predict the entire movement phase of the evacuation, consisting of movement inside the floor, queuing to the staircase and finally movement through a narrow staircase to the exit. The simulation geometry and the initial positions of the persons are shown in Figure 39. As the majority of persons in the building used the north exit door, the main results are for this door. Shown are also the results for the west door, where about 50% of the people originated from the first floor. In the simulations, only the second floor of

the building was simulated and people originating from the first floor were placed into the second floor. The north door was the only door with observed crowding.

The decision making processes were not modelled. Instead, the people were allocated for the north and west doors according to the ratio observed in the experiment. The simulations were performed using FDS5+Evac and standard input parameters for the human properties. The pre-movement times were generated from symmetric triangular distribution with mean of 31 s and lower and upper limits of 11 s and 71 s, respectively. A comparison of the simulated and experimentally observed flows is shown in Figure 40. As can be seen, the predicted flow rates are in very good agreement with the experiments. For the west door, the results reflect the goodness or badness of the assumed pre-movement time distribution because the flow rate through the door is so small. For the north door, the simulation is very relevant, because the flow rate is mainly determined by the geometry and the crowd dynamics during the queuing process.

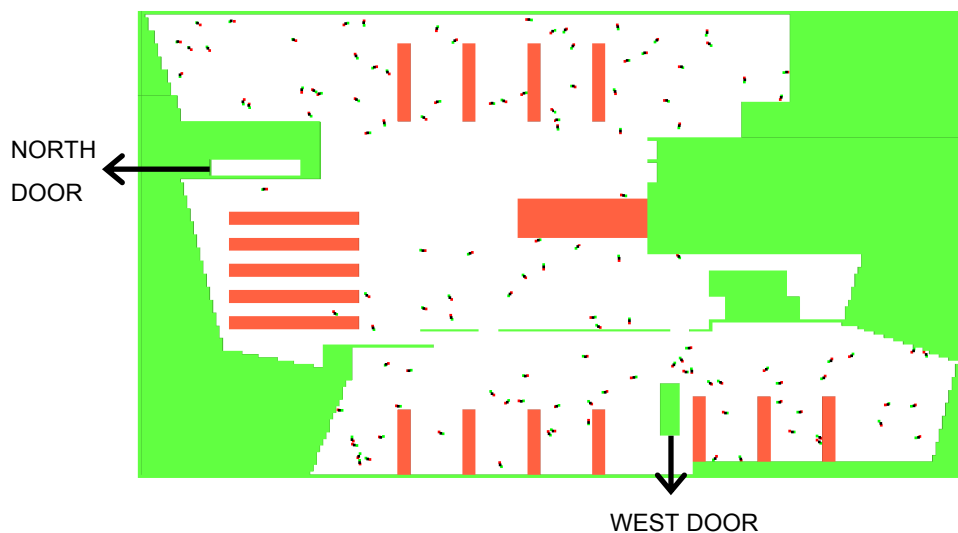

Figure 39. A snapshot from a FDS5+Evac simulation shows the geometry of the FDS+Evac model for the second floor of the public library.

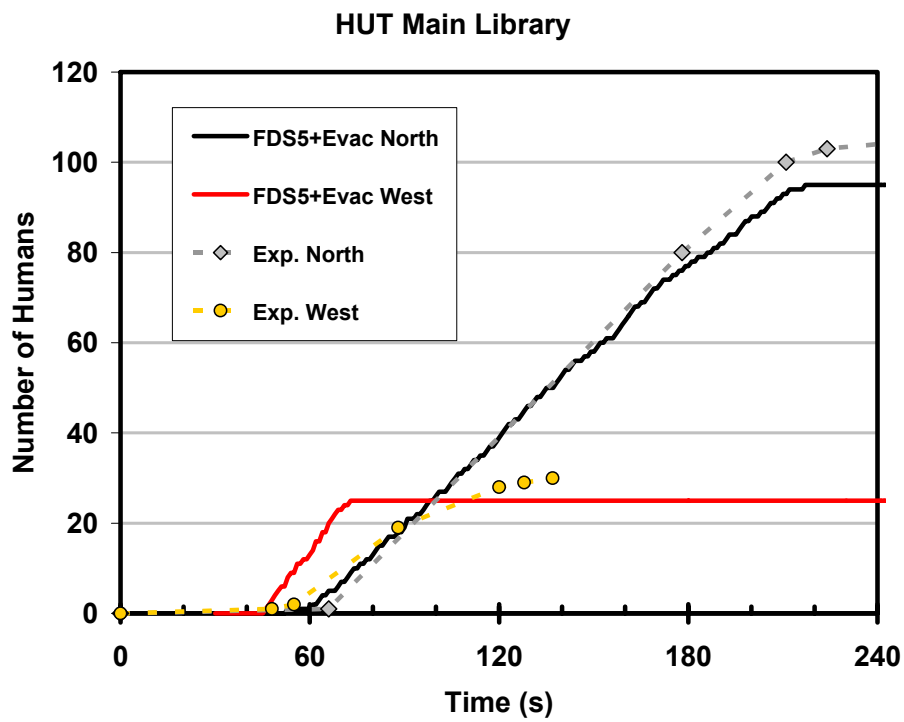

Figure 40. Comparison of FDS5+Evac simulation results and observations at the north and west doors of the public library.

6. Summary

The developed tool for the computational evacuation simulations, FDS+Evac, represents a new generation of evacuation models. The tool has been developed as a multidisciplinary project by the researchers of fire safety technology, system sciences and social psychology. A survey of the socio-psychological literature on evacuation situations was made to find out the effects most important for the decision making and group dynamics. The key features of the new computational tool are

- agent-based simulation of humans as individuals,
- ability to simulate the large and dense crowds and identification of hazardous clogging situations by the inclusion of real physical forces appearing in the egress situations,
- capability to consider socio-psychological effects like the small-groups and door selection, and a platform for implementation of more complicated phenomena like the majority and minority effects, and
- interaction between fire and humans.

The advanced experimental techniques to observe the human behaviour during evacuation tests were studied in the evacuation of public library and two office buildings. The use of surveillance cameras was studied using the video material recorded during an evacuation of large shopping centre. The video recording was still found to be the primary technique for experimental observations. Promising results were achieved for the use of RFID as a means to make observations on the human movement in the evacuation. By the careful placement of both the antennas and the tags to be detected, a sufficient reliability for scientific measurements can be achieved. The preparation and post-processing of the tag information is still relatively laborious.

A set of verification and validation cases for FDS+Evac has been documented. The validation data consisted of generic literature data for door and corridor flow rates and specific case studies of the public library and large office building. In most cases, FDS+Evac was shown to be able reproduce the experimental findings within the experimental uncertainty. For some cases, like the downward stair flow, a good agreement required adjustment of the model parameters.

7. Future work

The work described in this publication must be considered as a first step in the development of reliable and usable evacuation simulator. Improvements are needed in all fields of the modelling to reach a level of maturity required by the routine application in fire safety engineering. The modelling of the decision making process in particular is in its early stages. The human factors affecting the individual pre-movement time are not yet taken into account at any level. A model for the spreading of information and awareness within a crowd is then needed. Also, more complete description of the decisions made during the evacuation is needed, considering the minority and majority effects and the willingness to change the already selected exit route. Development of the movement algorithm is needed for the special cases like movement on moving ships and the movement of the disabled people.

Although not covered by this summary report, the usability of the FDS+Evac code can be improved by making the user input more simple, improving the post-processing display of humans and implementing the parallel processing feature for evacuation.

While the features and fields of application of the evacuation models become wider, more validation is needed. A comprehensive validation of the new decision making models is a real challenge in the future. Automatic video image analysis and post processing of the RFID results were not put in practice in the current project but may turn to be possible and crucial in the future. The exploitation of the surveillance camera recordings from large buildings during real fires and false alarms should be started. The surveillance cameras may provide the researchers with extremely valuable source of information, and thus the co-ordinated efforts to collect the data are needed at national and international levels.

References

- Asch, S. E. 1955. Opinions and Social Pressure. *Scientific American*, Vol. 193, pp. 31–35.
- Bryan, J. L. 1995. Behavioral Response to Fire and Smoke. In: DiNenno, P. J., Beyler, C. L., Custer, R. L. P., Walton, W. D., Watts Jr., J. M., Drysdale, D. and Hall Jr., J. R. (eds.) *SFPE Handbook of Fire Protection Engineering*. 2nd edition. Quincy, MA: National Fire Protection Association (NFPA). Pp. 241–261.
- Canter, D. 1980. Fires and Human Behaviour – an Introduction. In: Canter, D. (ed.) *Fires and Human Behaviour*. Chichester: John Wiley. Pp. 1–12.
- Daamen, W. 2004. Modelling Passenger Flows in Public Transport Facilities. PhD Thesis. The Netherlands: Delft University of Technology. 377 p. ISBN 90-407-2521-7.
- Dyregrov, A. 1994. Katastrofipsykologian perusteet (transl. to Finnish by T. Teva). Tampere: Vastapaino. (Original book: *Katastrofepsykologi*. Bergen: Fagbokforlaget, 1993.)
- Frantzich, H. and Nilsson, D. 2003. Utrymning genom tät rök: beteende och förflyttning. Report 3126. Lund, Sweden: Lund University, Department of Fire Safety Engineering. 75 p.
- Fritz, C. L. and Marks, E. S. 1954. The NORC studies of human behaviour in disaster. *Journal of Social Issues*, Vol. 10, pp. 26–41.
- Gwynne, S., Galea, E. R. & Lawrence, P. J. 2006. The Introduction of Social Adaptation within Evacuation Modelling. *Fire and Materials*, Vol. 30, pp. 285–309.
- Helbing, D. and Molnár, P. 1995. Social Force Model for Pedestrian Dynamics. *Physical Review E*, Vol. 51, pp. 4282–4286.
- Helbing, D., Farkas, I. and Vicsek, T. 2000. Simulating Dynamical Features of Escape Panic. *Nature*, Vol. 407, pp. 487–490.
- Helbing, D., Farkas, I., Molnár, P. and Vicsek, T. 2002. Simulating of Pedestrian Crowds in Normal and Evacuation Situations. In: Schreckenberg, M. and Sharma, S. D. (eds.) *Pedestrian and Evacuation Dynamics*. Berlin: Springer. Pp. 21–58.
- Heliövaara, S. 2007. Computational Models for Human Behavior in Fire Evacuations. M.Sc. Thesis. Espoo: Helsinki University of Technology.

Hostikka, S., Paloposki, T., Rinne, T., Saari, J.-M., Korhonen, T. and Heliövaara, S. 2007. Evacuation experiments in offices and public buildings. VTT Working Papers 85. Espoo: VTT. 52 p. ISBN 978-951-38-6636-5. <http://www.vtt.fi/inf/pdf/workingpapers/2007/W85.pdf>.

IMO. 2002. Interim guidelines for evacuation analyses for new and existing passenger ships. MSC/Circ.1033. London: International Maritime Organization.

Integrated Environmental Solutions Ltd. 1996. Simulex: Evacuation Modelling Software, User's Guide. Glasgow, Scotland. 48 p.

Janis, I. L. and Mann, L. 1977. Decision Making. A Psychological Analysis of Conflict, Choice and Commitment. New York: Free Press.

Jin, T. 1978. Visibility through Fire Smoke. *Journal of Fire & Flammability*, Vol. 9, pp. 135–155.

Keating, P. J. 1985. Human Response during Fire Situations: a Role for Social Engineering. *Proceedings of Research and Design 85: Architectural Applications of Design and Technology Research*. New York: American Institute of Architects. Pp. 285–288.

Korhonen, T. and Hostikka, S. 2008. Fire Dynamics Simulator with Evacuation FDS+Evac, version 5. Technical Reference and User's Guide. VTT Research Notes. Espoo: VTT. *To be published*.

Korhonen, T., Hostikka, S. and Keski-Rahkonen, O. 2005. A Proposal for the Goals and New Techniques of Modelling Pedestrian Evacuation in Fires. *Proceedings of the 8th International Symposium on Fire Safety Science*. International Association for Fire Safety Science. Pp. 557–567.

Korhonen, T., Hostikka, S., Heliövaara, S., Ehtamo, H. and Matikainen, K. 2007. Integration of an Agent Based Evacuation Simulation and the State-of-the-Art Fire Simulation. *Proceedings of the 7th Asia-Oceania Symposium on Fire Science & Technology*, 20–22 September, 2007.

Langston, P. A., Masling, R. and Asmar, B. N. 2006. Crowd Dynamics Discrete Element Multi-Circle Model. *Safety Science*, Vol. 44, pp. 395–417.

Latané, B. 1981. Psychology of Social Impact. *American Psychologist*, Vol. 36, pp. 343–356.

Marchant, E. W. 1980. Modelling Fire Safety and Risk. In: Canter, D. (ed.) *Fires and Human Behaviour*. Chichester: John Wiley. Pp. 293–314.

Mawson, A. R. 1980. Is the Concept of Panic Useful for Scientific Purposes? In: Levin, B. M. & Paulsen, R. L. (ed.) *Second International Seminar on Human Behavior in Fire Emergencies*. NBSIR 80-2070. Gaithersburg, MD: National Bureau of Standards. Pp. 208–211.

McGrattan, K. B., Hostikka, S., Floyd, J. E., Baum, H. and Rehm, R. 2007. *Fire Dynamics Simulator (Version 5): Technical Reference Guide*. NIST SP 1018-5. NIST Special Publication 1018-5. October 2007. Building and Fire Research Laboratory. National Institute of Standards and Technology.

Moscovici, S., Lage, E. and Naffrechoux, M. 1969. Influence of a Consistent Minority on the Responses of a Majority in a Colour Perception Task. *Sociometry*, Vol. 32, pp. 365–379.

Ozel, F. 2001. Time Pressure and Stress as a Factor during Emergency Egress. *Safety Science*, Vol. 38, pp. 95–107.

Paloposki, T., Myllymäki, J. and Weckman, H. 2002. Application of reliability techniques for calculation of the evacuation safety of a sports hall. VTT Research Notes 2181. Espoo: VTT. 53 p. + app. 13 p. In Finnish.

Pan, X. 2006. *Computational Modeling of Human and Social Behaviors for Emergency Egress Analysis*. PhD Thesis. Stanford, CA: Stanford University. 127 p.

Pauls, J. 1995. Movement of People. In: DiNenno, P. J., Beyler, C. L., Custer, R. L. P., Walton, W. D., Watts Jr., J. M., Drysdale, D. and Hall Jr., J. R. (eds.) *SFPE Handbook of Fire Protection Engineering*. 2nd edition. Quincy, MA: National Fire Protection Association (NFPA). Pp. 263–285.

Proulx, G. 1993. A Stress Model for People Facing a Fire. *Journal of Environmental Psychology*, Vol. 13, No. 2, pp. 137–147.

Purser, D. A. 1995. Toxicity Assessment of Combustion Products. In: DiNenno, P. J., Beyler, C. L., Custer, R. L. P., Walton, W. D., Watts Jr., J. M., Drysdale, D. and Hall Jr., J. R. (eds.) *SFPE Handbook of Fire Protection Engineering*. 2nd ed. Quincy, MA: National Fire Protection Association (NFPA). Pp. 2/28–2/146.

Quarantelli, E. L. 1985. What Is Disaster? The Need for Clarification in Definition and Conceptualization in Research. In: Sowder, B. J. (ed.) *Disasters and Mental Health: Selected Contemporary Perspectives*. Rockville, Maryland: National Institute of Mental Health.

Raphael, B. 2005. Crowds and Other Collectives: Complexities of Human Behaviors in Mass Emergencies. *Psychiatry*, Vol. 68, No. 2, pp. 115–120.

Sime, J. D. 1980. The Concept of Panic. In: Canter, D. (ed.) *Fires and Human Behaviour*. Chichester: John Wiley. Pp. 63–82.

Thompson, P. A. and Marchant, E. W. 1995. A Computer Model for the Evacuation of Large Building Populations. *Fire Safety Journal*, Vol. 24, pp. 131–148.

Tillander, K., Korhonen, T. and Keski-Rahkonen, O. 2005. Pelastustoimen määräiset seurantamittarit. VTT Working Papers 19. Espoo: VTT. 123 p. + app. 5 p. In Finnish. <http://www.vtt.fi/inf/pdf/workingpapers/2005/W19.pdf>.

<p>Author(s) Hostikka, Simo, Korhonen, Timo, Paloposki, Tuomas, Rinne, Tuomo, Matikainen, Katri & Heliövaara, Simo</p>		
<p>Title Development and validation of FDS+Evac for evacuation simulations Project summary report</p>		
<p>Abstract A new evacuation simulation tool has been developed with three main features: i) The tool can be used to simulate large and high density crowds, where the movement dynamics is affected by the crowd pressure. ii) The interaction between the evacuees and fire can be taken into account. iii) The decision making processes of the evacuees are modelled taking into account the socio-psychological aspects like the importance of familiar people (group dynamics) and places. The simulation tool has been implemented to the Fire Dynamics Simulator (FDS) software, and called FDS+Evac.</p> <p>In the experimental part, two different types of evacuation situations were studied. The first type was evacuation drills which are normally carried out as part of the safety training of the staff in public buildings and workplaces. The second type was actual evacuations which occur every now and then. The advantage of actual evacuations is that the decision making processes are likely to be similar to what they would be in case of a real fire.</p> <p>The main techniques used for the observation of evacuation drills were video cameras and Radio Frequency Identification (RFID). A large amount of information was obtained and the problems in the application of the observation techniques were identified. In the observation of an actual evacuation of a large shopping centre, the recordings of the surveillance cameras were used to measure the flow rates of people. The results are very promising and indicate that the collection of surveillance camera recordings from large evacuations should be started.</p>		
<p>ISBN 978-951-38-6981-6 (soft back ed.) 978-951-38-6982-3 (URL: http://www.vtt.fi/publications/index.jsp)</p>		
<p>Series title and ISSN VTT Tiedotteita – Research Notes 1235-0605 (soft back ed.) 1455-0865 (URL: http://www.vtt.fi/publications/index.jsp)</p>		<p>Project number 1102</p>
<p>Date December 2007</p>	<p>Language English</p>	<p>Pages 64 p.</p>
<p>Name of project Improvement of evacuation safety by combination of evacuation and fire simulations</p>		<p>Commissioned by Tekes, Finnish Fire Protection Fund, Ministry of the Environment, Academy of Finland, VTT</p>
<p>Keywords evacuation simulation, modelling, evacuation experiments, RFID, surveillance cameras</p>		<p>Publisher VTT Technical Research Centre of Finland P.O.Box 1000, FI-02044 VTT, Finland Phone internat. +358 20 722 4520 Fax +358 20 722 4374</p>

VTT Tiedotteita – Research Notes

- 2402 Mroueh, Ulla-Maija, Ajanko-Laurikko, Sirke, Arnold, Mona, Laiho, Anna, Wihersaari, Margareta, Savolainen, Ilkka, Dahlbo, Helena & Korhonen, Marja-Riitta. Uusien jätteenkäsittelykonseptien mahdollisuudet kasvihuonekaasupäästöjen vähentämisessä. 2007. 170 s. + liitt. 5 s.
- 2403 Toivonen, Santtu. Web on the Move. Landscapes of Mobile Social Media. 2007. 56 p. + app. 3 p.
- 2404 Vares, Sirje & Lehtinen, Jarkko. Lasipakkausten keräysjärjestelmän tehostaminen ja lasin hyötykäytön ympäristövaikutukset. 2007. 122 s.
- 2405 Olin, Markus, Lahti, Seppo, Valli, Asko, Hasari, Heikki, Koistinen, Ari & Leppänen, Seppo. SISU. Simuloinnin ja suunnittelun uudet sovellustavat ja liiketoiminta. Projektin tavoitteet ja simulointiesimerkkien yhteenveto. 2007. 58 s.
- 2406 Häkkinen, Kai, Hemilä, Jukka, Uoti, Mikko, Salmela, Erno, Happonen, Ari, Hämäläinen, Harri, Siniluhta, Eero, Nousiainen, Jukka & Kärkkäinen, Mikko. VMI teollisuudessa. Teoriaa, teknologiaa ja sovelluksia. 2007. 142 s.
- 2407 Koskela, Mika & Haajanen, Jyrki. Business Process Modeling and Execution. Tools and technologies report for SOAMeS project. 2007. 63 p. + app. 2 p.
- 2408 Kemppi, Paul. Next generation satellite navigation systems. 2007. 61 p. + app. 2 p.
- 2409 Pulakka, Sakari, Heimonen, Ismo, Junnonen, Juha-Matti & Vuolle, Mika. Talotekniikan elinkaarikustannukset. 2007. 58 s. + liitt. 3 s.
- 2410 Mikkola, Markku & Ryyänen, Tapani. Liiketoimintamallit talotekniikan elinkaari palveluissa. 2007. 40 s.
- 2411 Kaartinen, Tommi, Laine-Ylijoki, Jutta & Wahlström, Margareta. Jätteen termisen käsittelyn tuhkien ja kuonien käsittely- ja sijoitusmahdollisuudet. 2007. 44 s. + liitt. 20 s.
- 2412 Bioetanoliala maatalouden selluloosavirroista. von Weymarn, Niklas (toim.). 2007. 44 s.
- 2413 Pietiläinen, Jorma, Kauppinen, Timo, Kovanen, Keijo, Nykänen, Veijo, Nyman, Mikko, Paiho, Satu, Peltonen, Janne, Pihala, Hannu, Kalema, Timo & Keränen, Hannu. ToVa-käsikirja. Rakennuksen toimivuuden varmistaminen energiatehokkuuden ja sisäilmaston kannalta. 2007. 173 s. + liitt. 56 s.
- 2416 Vesanto, Petri, Hiltunen, Matti, Moilanen, Antero, Kaartinen, Tommi, Laine-Ylijoki, Jutta, Sipilä, Kai & Wilén, Carl. Kierrätyspolttoaineiden ominaisuudet ja käyttö. Selvitys kierrätyspolttoaineiden laatuominaisuuksista ja soveltuvuudesta leijupolttoon. 2007. 55 s. + liitt. 4 s.
- 2417 Leinonen, Arvo. Wood chip production technology and costs for fuel in Namibia. 2007. 66 p. + app. 21 p.
- 2421 Hostikka, Simo, Korhonen, Timo, Paloposki, Tuomas, Rinne, Tuomo, Matikainen, Katri & Heliövaara, Simo. Development and validation of FDS+Evac for evacuation simulations. Project summary report. 2007. 64 p.

Julkaisu on saatavana

VTT
PL 1000
02044 VTT
Puh. 020 722 4520
<http://www.vtt.fi>

Publikationen distribueras av

VTT
PB 1000
02044 VTT
Tel. 020 722 4520
<http://www.vtt.fi>

This publication is available from

VTT
P.O. Box 1000
FI-02044 VTT, Finland
Phone internat. + 358 20 722 4520
<http://www.vtt.fi>
